

IndraControl XM21, XM22

Controls

Operating Instructions
R911340667

Edition 03



Change Record

Edition	Release Date	Notes
Edition 01	2014-07	First edition
Edition 02	2016-08	Revised edition
Edition 03	2017-03	Notes on the explosion protection (Atex) supplemented for XM22

Copyright

© Bosch Rexroth AG 2017

This document, as well as the data, specifications and other information set forth in it, are the exclusive property of Bosch Rexroth AG. It may not be reproduced or given to third parties without its consent.

Liability

The specified data is intended for product description purposes only and shall not be deemed to be a guaranteed characteristic unless expressly stipulated in the contract. All rights are reserved with respect to the content of this documentation and the availability of the product.

Editorial Department

Development automation systems, control platform HP (MK/MePe)

Table of Contents

	Page
1 About this documentation.....	1
1.1 Overview on target groups and product phases.....	1
1.2 Scope.....	1
1.3 Related documents.....	2
1.4 Customer feedback.....	2
2 Product identification and scope of delivery.....	2
2.1 Product identification.....	2
2.2 Scope of delivery.....	3
3 Use of the safety instructions.....	3
3.1 Structure of the safety instructions.....	3
3.2 Explaining signal words and safety alert symbol.....	3
3.3 Symbols used.....	4
3.4 Signal graphic explanation on the device.....	4
4 Intended Use.....	5
5 Spare parts, accessories and wear parts.....	5
5.1 Power connectors, 24 V.....	5
5.2 Bus base module for IndraControl XM21/XM22.....	6
5.3 Bus base module for IndraControl S20 I/O.....	6
5.4 SD card.....	6
5.5 End clamp.....	6
5.6 Wear parts.....	6
6 Ambient conditions.....	6
7 Technical data.....	8
7.1 Voltage supply and current consumption.....	9
8 Standards.....	9
8.1 Standards used.....	10
8.2 CE marking.....	10
8.2.1 Declaration of conformity.....	10
8.3 UL/CSA certified.....	10
8.4 Explosion protection certification (XM2201.01-.....)	11

	Page
8.4.1	Power matrix..... 13
8.4.2	Standards used..... 13
8.5	Marine and offshore certification (XM2201...)..... 13
9	Interfaces..... 14
9.1	Connection position..... 14
9.2	Extension bus..... 15
9.3	S20 interface..... 15
9.4	Control bus base module 15
10	Mounting, demounting and electric installation..... 16
10.1	Installation notes..... 16
10.2	Housing dimensions..... 18
10.3	Mounting the control..... 19
10.4	Mounting S20 I/O modules..... 20
10.5	Mounting extension modules..... 21
10.6	Demounting the control and the control bus base module..... 22
10.6.1	Demounting steps..... 22
10.7	Electric installation..... 24
10.7.1	External power supply unit 24
10.7.2	Voltage supply for the control..... 25
10.7.3	24 V voltage supply..... 26
10.7.4	Grounding 28
10.7.5	Shielding..... 29
11	Commissioning..... 29
11.1	Commissioning steps..... 29
11.2	Establishing a connection to the engineering PC via the USB device interface "XF31" 30
12	Device description..... 33
12.1	LEDs and operating elements..... 34
12.1.1	LEDs in the XD1 plug..... 34
12.1.2	LED block of 10..... 35
12.1.3	Operation mode switches 36
12.1.4	Reset button..... 37
12.2	Initial firmware..... 38
12.2.1	License information..... 39

	Page
12.2.2 LED states.....	39
12.2.3 Starting and opening the initial firmware.....	40
12.2.4 Installing a backup from an external SD card.....	41
12.3 Booting.....	42
12.4 Fallback and recovery.....	42
12.5 IndraControl First Touch.....	43
12.5.1 Hardware data.....	44
12.5.2 Network settings.....	44
12.5.3 Firmware management.....	45
12.5.4 File manager.....	50
12.5.5 Core dump.....	51
12.6 Backing up remanent data.....	52
12.7 Real-time clock.....	52
13 Error causes and troubleshooting.....	53
14 Maintenance.....	54
14.1 Regular maintenance tasks.....	54
15 Ordering information.....	54
15.1 Type code.....	55
15.2 Accessories and spare parts.....	56
16 Disposal.....	57
16.1 General Information.....	57
16.2 Return.....	57
16.3 Packaging.....	57
17 Service and support.....	57
Index.....	59

1 About this documentation

1.1 Overview on target groups and product phases

In the following illustration, the framed activities, product phases and target groups refer to the present documentation.

Example: In the product phase "Mounting (assembly/installation)", the target group "mechanic/electrician" can execute the activity "install" using this documentation.

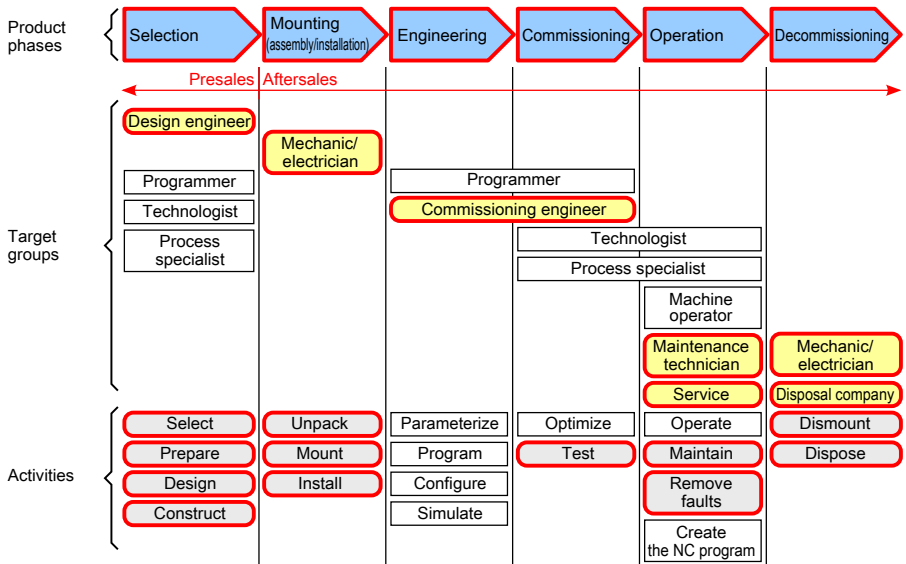

Fig. 1-1: Assigning the present documentation to the target groups, product phases and activities of the target group

This document instructs the technical staff of the machine manufacturer on how to safely perform the mechanical and electrical installation and on how to commission the device.

Required qualification: Individual who is able to assess the tasks assigned and to identify possible safety risks owing to qualification in the subject, knowledge and experience. The individual should also be familiar with the standards and regulations.

1.2 Scope

This operating instructions is valid for all variants of the control, whose type codes start with:

XM21...

XM22...

The type code specifications are located on the type plate of the device. Also refer to [chapter 2 "Product identification and scope of delivery" on page 2](#).

1.3 Related documents

Title	Part number and document type
Rexroth IndraControl S20:	R911335988
System and Installation	Application Description
Rexroth IndraControl S20:	R911344826
Diagnostic Tabs and Error Messages	Application Description

Tab. 1-1: Related documents

The XM2x controls are provided as function package with the systems IndraMotion MLC and IndraMotion MTX. The ordering data (type code, part number) differ according to the selected function package (system functions). The hardware characteristics described in this document apply to all available function packages. For more information on the function packages, refer to the respective system descriptions.

For related documents, go to the "Rexroth Media Directory" at <http://www.boschrexroth.com>.

1.4 Customer feedback

Customer requests, comments or suggestions for improvement are of great importance to us. Please email your feedback on the documentations to Feedback.Documentation@boschrexroth.de. Directly insert comments in the electronic PDF document and send the PDF file to Bosch Rexroth.

2 Product identification and scope of delivery

2.1 Product identification

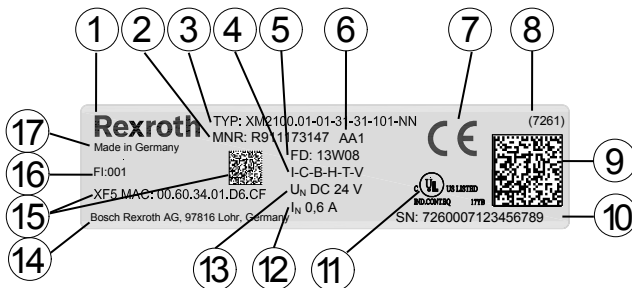

- 1 Word mark
2 Part number

- 3 Type name (type code)
4 Check digit

5	Date of manufacture (yyWww)	12	Nominal current
6	State of revision	13	Nominal voltage
7	CE conformity marking	14	Company address
8	Plant number	15	MAC address, MAC address as barcode
9	QR code	16	Functional index
10	Serial number	17	Manufacturing country
11	Underwriters Laboratories Inc. mark		

Fig. 2-1: Exemplary type plate

2.2 Scope of delivery

- IndraControl XM21 or IndraControl XM22
- 24 V power connector XA-CN01
- Bus base module:
 - XA-BS01 (for S20 connection right)
 - XA-BS02 (for S20 connection right and extension modules left)

3 Use of the safety instructions

3.1 Structure of the safety instructions

The safety instructions are structured as follows:

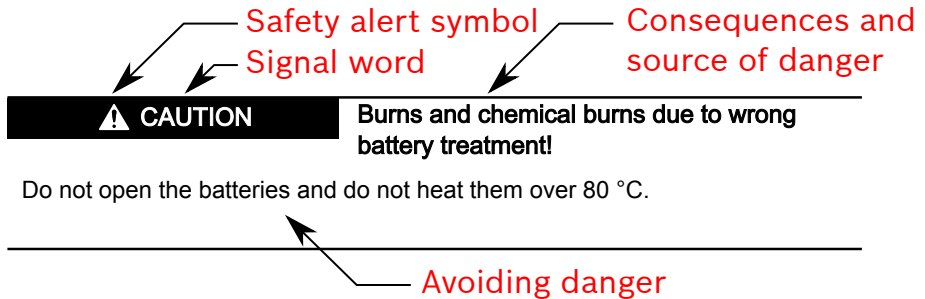

Fig. 3-1: Structure of the safety instructions

3.2 Explaining signal words and safety alert symbol

The safety instructions in this documentation contain specific signal words (danger, warning, caution, notice) and, if necessary, a safety alert symbol (according to ANSI Z535.6-2006).

The signal word is used to draw attention to the safety instruction and also provides information on the severity of the hazard.

The safety alert symbol (a triangle with an exclamation point), which precedes the signal words danger, warning and caution is used to alert the reader to personal injury hazards.

⚠ DANGER

In case of non-compliance with this safety instruction, death or serious injury **will** occur.

⚠ WARNING

In case of non-compliance with this safety instruction, death or serious injury **can** occur.

⚠ CAUTION

In case of non-compliance with this safety instruction, minor or moderate injury can occur.

NOTICE

In case of non-compliance with this safety instruction, material damage can occur.

3.3 Symbols used

Hints are represented as follows:



This is an information.

Tips are represented as follows:



This is a tip.

3.4 Signal graphic explanation on the device



Prior to the installation and commissioning of the device, refer to the device documentation.

4 Intended Use

NOTICE

Danger of device damage if not the expressly stated accessories, mounting parts, components, cables, lines, software and firmware are used.

The IndraControl XM21/XM22 control may only be used with the accessories and mounting parts listed in this documentation. Components that are not expressly mentioned must neither be attached nor connected. The same applies to cables and lines.

Only to be operated with the component configurations and combinations expressly defined and with the software and firmware specified in the corresponding functional description.

Typical areas of application of the IndraControl XM21/XM22 are:

- Handling systems and assembly systems
- Packaging and food processing machines
- Printing machines and paper converting machines
- Machine tools
- Wood working machines

The IndraControl XM21/XM22 control may only be operated under the mounting and installation conditions, the position, and the ambient conditions (temperature, degree of protection, humidity, EMC etc.) specified in the related documentation.

5 Spare parts, accessories and wear parts

5.1 Power connectors, 24 V

Ordering code	Part number	Description
XA-CN01	R911173741	24 V plug

Tab. 5-1: Power connectors, 24 V

5.2 Bus base module for IndraControl XM21/XM22

Ordering code	Part number	Description
XA-BS01	R911342346	Bus base module for IndraControl S20 connection (right)
XA-BS02	R911342347	Bus base module for IndraControl S20 connection (right) and extension modules (left)

Tab. 5-2: Bus base modules IndraControl XM21/XM22

5.3 Bus base module for IndraControl S20 I/O

Ordering code	Part number	Description
S20-BS	R911172540	Bus base module for wide IndraControl S20 I/O modules
S20-BS-S	R911173203	Bus base module for narrow IndraControl S20 I/O modules

Tab. 5-3: Bus base modules for S20 I/O

5.4 SD card

Ordering code	Part number	Description
XA-SD01	R911173844	SD card 1 GB

Tab. 5-4: SD card

5.5 End clamp

Ordering code	Part number	Description
SUP-M01-ENDHALTER	R911170685	2 pieces of snap-on end brackets for 35 mm NS 35/7.5 or NS 35/15 carrier plate; width: 9.5 mm

Tab. 5-5: End clamp

5.6 Wear parts

There are no wear parts in the controls IndraControl XM21 and XM22.

6 Ambient conditions

Ambient temperature in operation	Up to 2,000 m: -25 °C to +60 °C 2,000 m to 3,000 m: max. +55 °C 3,000 m to 4,000 m: max. +50 °C 4,000 m to 4,700 m: max. +45 °C
Ambient temperature during storage and transport	-30 °C to +85 °C

Operating altitude	Up to 4,700 m above sea level acc. to DIN 60204
Permitted air humidity	5 % to 95 % acc. to DIN EN 61131-2, no condensation
Degree of protection	IP20 acc. to DIN EN 60 529
Protection class	III, DIN EN 61010-2-201
Overvoltage category	2
Contamination level	2, no condensation allowed

Mechanical tests

Vibration resistance acc. to DIN EN 60068-2-6 ^①	Oscillations, sinusoidal in all three axes 5 Hz - 9 Hz with 3.5 mm amplitude 9 Hz - 150 Hz with 5 g peak acceleration
Shock test acc. to DIN EN 60068-2-27	Shock stress: Shock resistance in all three axes, 11 ms semi-sinusoidal 30 g
Broadband noise acc. to DIN EN 60068-2-64	5-20-150 Hz with 0.572 g, 5 h per axis

Electrostatic discharge

ESD resistance acc. to DIN EN 61131-2	Criterion B
● Test voltage	8 kV for air discharge 6 kV for contact discharge

① The vibration stress specifications assume the use of industrial-suited RJ45 plug connections. The "Industrial RJ45 plug" of the company Yamaichi is recommended (Y-Con-Plug-41). The cables are available as accessories (RKB0020). To protect against vibration, secure the cables with a short distance (< 20 cm). The USB interfaces XF30 and XF31 may only be used up to a vibration stress of 1 g.

Tab. 6-1: Ambient conditions**NOTICE****Failure of the product due to contaminated air**

- The ambient air must not contain acids, alkaline solutions, corrosive agents, salts, metal vapors and other electrically conductive contaminants in high concentrations
- Housing and installation compartments must at least comply with the degree of protection IP 54 according to DIN EN 60529

NOTICE**Defective product due to gases jeopardizing functions**

Due to the risk of corrosion, avoid sulphurous gases (e.g. sulphur dioxide (SO₂) and hydrogen sulphide (H₂S)). The product is not resistant against these gases.

NOTICE**Failure of the product due to overheating**

To avoid overheating and to ensure a smooth operation of the product according to the minimum distances specified in [chapter 10.1 "Installation notes" on page 16](#), air has to circulate.



This is a product that corresponds to the limit values of the emitted interference of class A (industrial environments), but not of class B (residential area and small enterprises).

When using the product in residential areas or small enterprises, the operator has to take actions to prevent radio interferences (also refer to DIN EN 55022).

7 Technical data

Processor	IndraControl XM21: Intel E620T 600 MHz (CPU frequency) IndraControl XM22: Intel E660T 1300 MHz (CPU frequency)
RAM	512 MB DRAM
Connection for extension modules	Via the control bus base module XA-BS02
Extension bus	
Number of possible modules	3
Connection for S20 I/O	Via control bus base module XA-BS01 or XA-BS02
S20 bus parameters	
Transmission rate	100 MBit/s
Number of connectable modules	Max. 63 (per station) 2 A
Max. current for the S20 bus (U_{Bus})	
Communication interfaces	RJ45 connections: <ul style="list-style-type: none"> ● 1 × Ethernet connection (10 MB, 100 MB, 1 GB) ● 2 × Sercos III master/slave interface USB ports: <ul style="list-style-type: none"> ● 1 × USB host, maximum cable length 3 m (for the functionality, refer to the system description of the respective system) ● 1 × USB device, maximum cable length 3 m (for the functionality, refer to the system description of the respective system)
SD card	Slot for SD card

Weight	0.38 kg (incl. supply connectors)
Dimensions	Refer to chapter 10.2 "Housing dimensions" on page 18

Tab. 7-1: Technical data

7.1 Voltage supply and current consumption

The following values apply to the operating voltage acc. to DIN EN 61131-2:

Nominal voltage at U_{LS}	24 V DC SELV/PELV
Maximum voltage range of the supply voltage allowed U_{LS}	18 V DC to 31.2 V DC (incl. all tolerances and ripple)
Current consumption of the control incl. the connected S20 I/O modules from U_{LS} at nominal voltage	Maximum 1.5 A
Current consumption of the control without the connected S20 I/O modules from U_{LS} at nominal voltage	Typically 1.0 A
Power consumption of the control incl. the connected S20 I/O modules from U_{LS} at nominal voltage	Maximum 36 W
Power consumption of the control without the connected S20 I/O modules from U_{LS} at nominal voltage	Typically 24 W
Reverse voltage protection of the supply voltage	Diode
Fuse protection	Internal protective fuse, 2.5 A
Transient protection	Present, suppressor diodes
Pulse load up to 1,500 W	
Voltage dips at current supply interfaces	PS2 < 10 ms, evaluation criterion A
Electrical isolation 24 V supply U_{LS} to the functional earth	No separation between 0 V of the U_{LS} and FE (housing)

Tab. 7-2: Operating voltage and current consumption

NOTICE

Electronic damage due to polarity reversal or due to a nominal current that is too low

The power supply unit has to be able to deliver the quadruple nominal current of the protective fuse to ensure that the fuse reliably triggers in case of an error.

8 Standards

The products have been developed according to the German edition of the standards published at the time of product engineering.

8.1 Standards used

Standard	Meaning	Edition
IEC 60204-1	Electrical equipment of machines	2007
IEC 61131-2	Programmable controllers	2008
IEC 60529	Degrees of protection provided by enclosures (IP Code)	2014
IEC 61010-2-201	Safety requirements for electrical equipment for measurement, control and laboratory use	2014
UL 61010-2-201	Safety requirements for electrical equipment for measurement, control and laboratory use	2014

Tab. 8-1: Standards used

8.2 CE marking

8.2.1 Declaration of conformity



The electronic products described in the present operating instructions comply with the requirements and the target of the following EU directive and with the following harmonized European standards:

EMC directive 2014/108/EC

The electronic products described in the present operating instructions are intended for use in industrial environments and comply with the following requirements:

Standard	Title	Edition
DIN EN 61000-6-4	Electromagnetic compatibility (EMC) Part 6-4: Generic standards – Emission standard for industrial environments	September 2011
DIN EN 61000-6-2	Electromagnetic compatibility (EMC) Part 6-2: Generic standards – Immunity for industrial environments	March 2006

Tab. 8-2: Standards for electromagnetic compatibility (EMC)



Loss of CE conformity due to modifications at the device.

CE marking applies only to the device upon delivery. After modifying the device, verify the CE conformity.

8.3 UL/CSA certified



The devices are certified acc. to

- **UL 61010-2-201** (Industrial Control Equipment) and
- **CSA22.2 No. 61010-2-201** (CSA)

However, there can be combinations or extension stages with a limited or missing certification. Thus, verify the registration according to the UL marking on the device.



Loss of UL/CSA conformity due to modifications at the device.

UL and CSA marking applies only to the device upon delivery. After modifying the device, verify the UL and the CSA conformity.



To guarantee an UL/CSA-compliant operation, the following conditions have to be fulfilled:

- Use only insulated copper wire suitable for at least 60/75°C

8.4 Explosion protection certification (XM2201.01-...)



Ex II	Explosion protection label Equipment group II: Explosive gas atmospheres	Gc	Equipment protection level (EPL), rare and momentary explosive atmosphere (zone 2): Flammable gases, vapors, mists
3G	Equipment category 3: Explosive atmosphere (zone 2)	TÜV...	ATEX EU type examination certificate
Ex ec	Explosion protection label Type of protection "Increased safety"	IECEX...	IECEX certificate number
IIC	Gas group IIC, hydrogen	...X	Note on special conditions, refer to the following note.
T4	Maximum surface temperature 135 °C		

Fig. 8-1: Exemplary type plate

The approval numbers given on the type plate are marked at the end with an "X" for devices and a "U" for components. "X" indicates special conditions to be observed together with the safety and health regulations given in the standards. "U" indicates a component (Ex component) that may not be used on its own.



Observe the following special conditions for a safe operation of the devices and components:

- The explosion protection approval applies only to the control XM2201.01-....
- The explosion protection approval is only valid if the devices and components approved by Bosch Rexroth are used as intended, refer to [chapter 4 "Intended Use" on page 5](#).
- The XM22 control may only be used together with the additional components and accessories approved by Bosch Rexroth. Otherwise, the explosion protection approval does not apply.
- In case of unintended modifications at the device or at the components, the explosion protection approval does also not apply. For maintenance and troubleshooting, refer to [chapter 14 "Maintenance" on page 54](#) and [chapter 13 "Error causes and troubleshooting" on page 53](#).
- The XM22 control may only be used in an area with the minimum pollution degree 2 as defined in IEC 60991-1.
- For the permitted ambient temperature range, refer to [chapter 6 "Ambient conditions" on page 6](#).
- The XM22 control may only be installed in a housing (control cabinet) providing at least an ingress protection of IP54 in compliance with IEC 60079-0.
- Take suitable actions to ensure that the supply voltage outside the device or the component is always within the permitted voltage range ($\pm 10\%$) acc. to EN 60079-0.
- Maintenance and repair work may only be carried out by the certified Rexroth service.
- Always store and transport the device or the component in the original package.

⚠ DANGER

Explosion hazard

Working at the device is only permitted if there is no explosive atmosphere.

⚠ DANGER

Explosion hazard when exceeding or falling below the ambient temperature

Do not exceed the ambient temperature permitted, refer to [chapter 6 "Ambient conditions" on page 6](#)

8.4.1 Power matrix

Devices and components	Max. internal current consumption	Max. internal power consumption
XM2201.01.-..... R911173148	1500 mA	36.0 W
XFE01.1-FB-03 R911173397	200 mA	4.8 W
XFE01.1-FB-20 R911173957	200 mA	4.8 W
S20-AI6-AO2- SSI2 R911173120	100 mA	2.4 W
S20-PWM-4-T R911173461	400 mA	9.6 W

Tab. 8-3: Power matrix of the XM22 control and the approved components



If the housing surface (control cabinet) is 1m², up to 87 W of internal power consumption of the individual devices and components are permitted.

8.4.2 Standards used

Standard	Title
EN 60079-0:2012 + A11:2013	Explosive atmospheres –
IEC 60079-0:2011, modified + Corr.:2012 + Corr.:2013	Part 0: Equipment – General requirements
EN 60079-7:2015	Explosive atmospheres –
IEC 60079-7:2015	Part 7: Equipment protection by increased safety "e"

Tab. 8-4: Standard used for explosion protection

8.5 Marine and offshore certification (XM2201...)

The control XM2201 ... is suitable for the use in marine and offshore applications and was approved by the following certification organizations:

- DNV-GL Det Norske Veritas, Germanischer Lloyd DCTC_30826-001
- ABS American Bureau of Shipping DCTC_30826-002
- RINA Registro Italiano Navale DCTC_30826-003
- LR Lloyd's Register DCTC_30826-004
- BV Bureau Veritas DCTC_30826-005

- BSH Bundesamt für Seeschifffahrt und Hydrographie DCTC 30826-006



For more information, refer to www.boschrexroth.com/dcc/Vornavigation/VorNavi.cfm?PageID=p650746.

9 Interfaces

9.1 Connection position

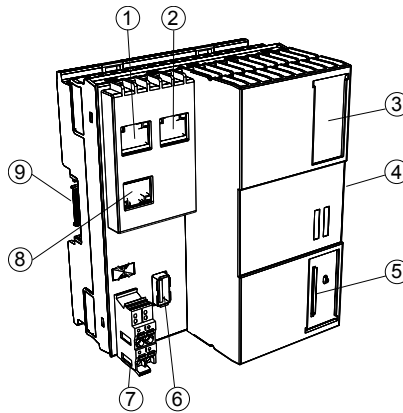

Fig. 9-1: Interfaces

NOTICE

Attaching and detaching connections under voltage can damage the control!

Switch off the supply voltage before attaching or detaching any connections!

No.	Name	Connection type	Connector type (Integrated)	Mating connector and cable (From outside)
①	XF1	Ethernet (Sercos)	RJ45 socket 8-pin	RJ45 plug (Twisted pair, 8-wire)
②	XF2	Ethernet (Sercos)	RJ45 socket 8-pin	RJ45 plug (Twisted pair, 8-wire)
③	XF31	USB device USB 2.0	Micro USB socket 4-pin	Micro USB plug (4-wire)

No.	Name	Connection type	Connector type (Integrated)	Mating connector and cable (From outside)
④		S20 bus	Bus base module 32-pin	Bus base module for S20 I/O modules 32-pin
⑤	SD	Slot for SD card	–	SD card
⑥	XF30	USB host USB 2.0	USB TYPE A-socket 4-pin	USB TYPE A-plug (4-wire)
⑦	XD1	24 V plug U_{LS}	4-pin	(4-wire)
⑧	XF5	Ethernet (TCP/IP, RT Ethernet)	RJ45 socket 8-pin	RJ45 plug (Twisted pair, 4-/8-wire)
⑨		Extension bus	Bus base module 32-pin	Bus base module for exten- sion modules 32-pin

Tab. 9-1: Control interfaces

9.2 Extension bus

Up to three extension modules can be freely connected at the left of the control. The extension modules have to be attached without any gaps via the extension bus base modules on the left side of the IndraControl XM21/XM22 and supplied with the same 24 V supply voltage. Switch on and off the 24 V supply voltage of the extension modules synchronously with the IndraControl XM21/XM22.

9.3 S20 interface

Up to 63 S20 modules can be connected to the S20 interface on the right of the IndraControl XM21/XM22 via S20 bus base modules. The number of connectable modules depends on the total current consumption of the S20 modules. The IndraControl XM21/XM22 can provide up to 2 A for the power supply of the S20 modules.

9.4 Control bus base module

The control bus base module is connected at the bottom side of the IndraControl XM21/XM22. The control bus base module is available in two variants:

- BUSMODUL XA-BS01 connects the IndraControl XM21/XM22 with the S20 modules on the right control side
- BUSMODUL XA-BS02 connects the IndraControl XM21/XM22 with the S20 modules on the right control side and the extension modules on the left control side

Depending on the function package, one of the bus base modules (XA-BS01 or XA-BS02) is included upon delivery (see [chapter 5 "Spare parts, accessories and wear parts"](#) on page 5).

10 Mounting, demounting and electric installation

10.1 Installation notes

NOTICE

Module destruction due to electrostatic discharge

The XM2x control contains components that can be damaged or destroyed by electrostatic discharge. Comply with the required safety measures against electrostatic discharge (ESD) acc. to EN 61340-5-1 when operating the control.

- Mounting location

The XM2x control has the degree of protection IP20 and is thus intended for the use in a closed control cabinet or control box (terminal box) of the degree of protection IP54 or higher.

- Mounting rail

Mount the XM2x control on a 35 mm standard mounting rail. The preferred overall height of the mounting rail is 7.5 mm (corresponds to TH 35-7.5 acc. to EN 60715).

Mount the control and the bus base module as described in the following.

The fastening distance of the mounting rails may not exceed 200 mm. This distance is required to ensure stability while mounting and demounting the control or the S20 I/O modules.

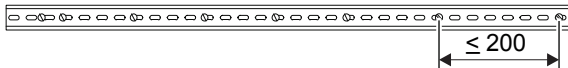

Fig. 10-1: Mounting rail fastening (in mm)

NOTICE

Electronic damage due to fastening elements Danger of malfunction

If the fastening elements (screws, rivets,...) are too high, the bus base modules do not correctly engage on the mounting rail. Use only elements with a structural height of up to 3 mm to fasten the mounting rail.

- End clamp

Fasten end clamps on both sides of the IndraControl XM station (control, extension modules, S20 I/O modules).

End clamps guarantee the correct fastening of the XM2x control and the S20 I/O modules connected to them on the mounting rail and they are used as lateral end elements.

Always fasten the left end clamp of the station before mounting the control. This ensures the following:

- It impedes the shifting of the control.
 - The installation place for the end clamps is guaranteed.
 - If the control has to be replaced, there is sufficient space to separate the control from the S20 bus base modules.
 - They have a counterpressure against the engaging forces when mounting the S20 bus base modules in series to the control.
- Do not wire cables parallel to motor cables or other strong interference sources to avoid coupling of interferences
 - The cabling of the Ethernet wires may not leave the building
 - The LED displays on the operating panel must not be covered
 - Observe the bending radius of the cables used when laying the connecting lines
 - Use strain reliefs for all cables
 - Install the control only horizontally on a mounting rail attached to a wall
 - Keep the maximum distance possible from interference sources
 - Provide the following minimum distances for sufficient cooling:

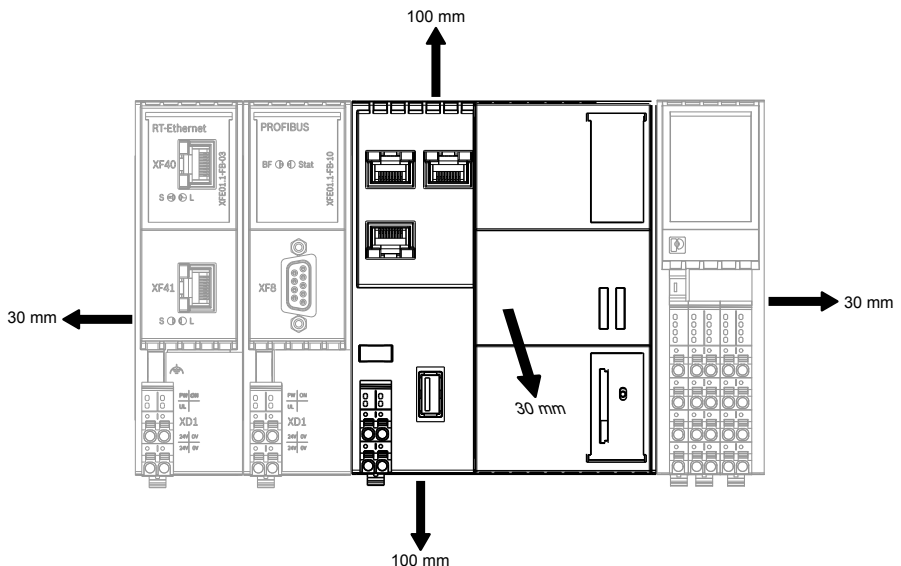

Fig. 10-2: Minimum distances for the circulation of ambient air

In case of a several line design, the supply air has to be measured under each line and its limit value has to be observed. For information on ambient temperatures, refer to [chapter 6 "Ambient conditions" on page 6](#)

- Additionally, provide sufficient distance for mounting, demounting, plugs and cables

For more information on mounting, demounting and connecting lines, refer to the application description "IndraControl S20: System and Installation", part no. [R911335988](#).

10.2 Housing dimensions

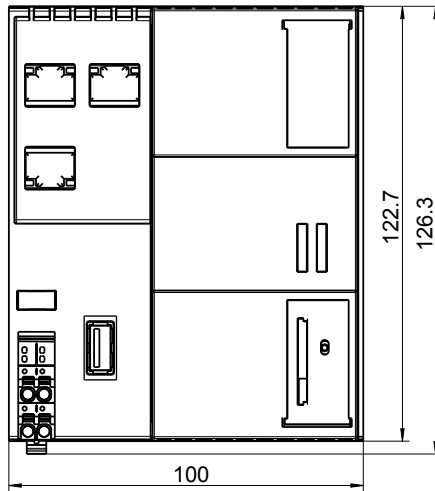

Fig. 10-3: Front view

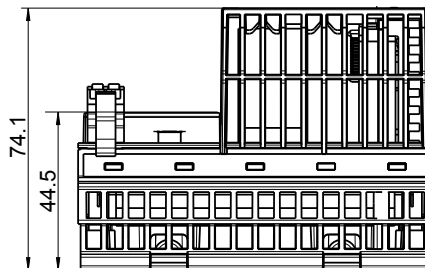

Fig. 10-4: Bottom view

10.3 Mounting the control

NOTICE

Damages at the contacts by tilting the modules

Place the modules vertically on the mounting rail and remove them vertically from the mounting rail as well.

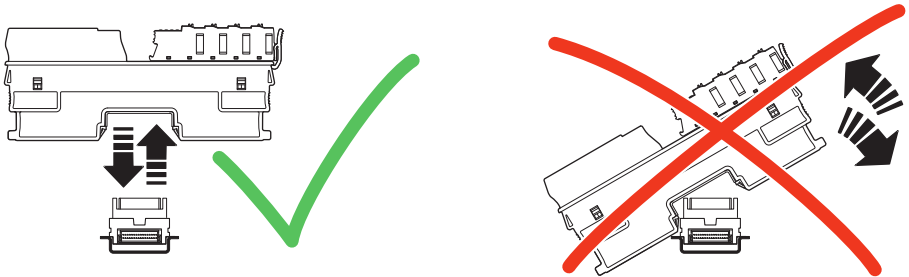

Fig. 10-5: Positioning and removing modules only vertically

NOTICE

Destruction of components due to plug mounting under voltage!

- Before mounting or demounting components, disconnect the control - including its components - from voltage
- Connect the voltage only after the control and its components have been set up

NOTICE

Possible damage to property due to improper mounting of the top-hat rail

- Fasten the top-hat rail adequately
- Connect the top-hat rail to a functional ground
- Mount the control on the top-hat rail as the top-hat rail is among other things used for heat dissipation and grounding
- Install the control in a control cabinet or an appropriate housing

Mounting the control bus base module

1. Press the control bus base module on the top-hat rail until all latching are safely closed.

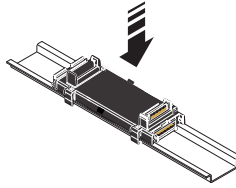

Fig. 10-6: Mounting the bus base module

2. Mount the S20 bus base module as shown in [fig. 10-8 "Connect S20 bus base modules among each other and with the control bus base module" on page 21.](#)

Mounting the control to the bus base module

1. Press the control on the premounted bus base module until all latching are safely closed.

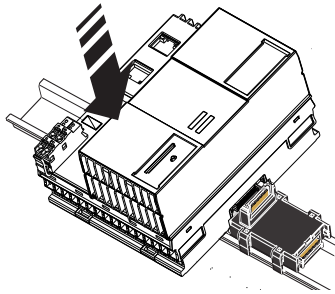

Fig. 10-7: Snapping the control



Note the minimum distances for control cooling (see [chapter 10.1 "Installation notes" on page 16.](#))

10.4 Mounting S20 I/O modules



The S20 bus base modules can only be mounted if the control is not attached to the control bus base module.

Mounting S20 bus base modules

1. Press the S20 bus base modules for the S20 modules on the top-hat rail on the right next to the control bus base module until all latching are safely closed (see (A) in the following figure).
2. Move the first S20 bus base module (see (B)) to the left and connect the S20 bus base module with the bus base module of the control (see (D) in the following figure).

3. Move the other S20 bus base modules to the left until all bus base modules are connected with each other (see (C) in the following figure).

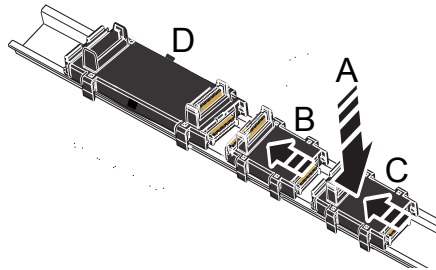

Fig. 10-8: Connect S20 bus base modules among each other and with the control bus base module

Mounting S20 modules to the bus base modules

1. Press the S20 modules on the premounted bus base modules.

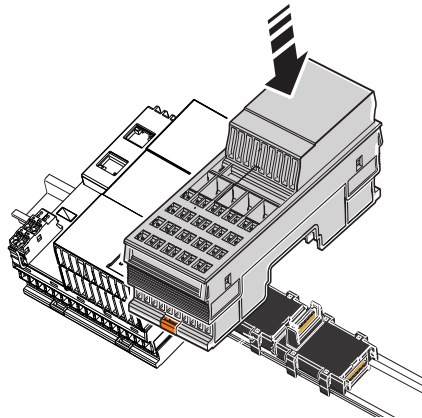

Fig. 10-9: Positioning S20 modules

10.5 Mounting extension modules



The extension bus base modules can only be mounted if the control is not attached to the control bus base module.

Mounting extension bus base modules

1. Press the extension bus base modules for the extension modules on the top-hat rail on the left next to the control bus base module until all latching mechanisms are safely closed (see (A) in the following figure).
2. Move the first extension bus base module (see (B) to the right and connect the extension bus base module with the bus base module of the control (see (D) in the following figure).
3. Move the other extension bus base modules to the right until all bus base modules are connected with each other (see (C) in the following figure).

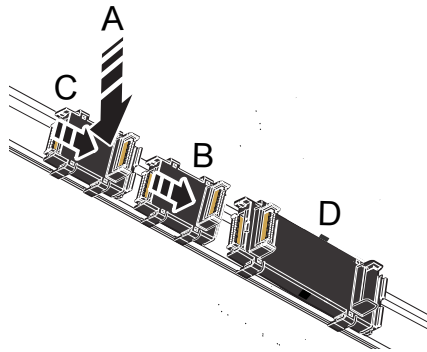

Fig. 10-10: Connect extension bus base modules among each other and with the control bus base module

Mounting extension modules to the extension bus base modules

1. Press the extension modules on the pre-mounted extension bus base modules.

10.6 Demounting the control and the control bus base module



To demount, use a common tool such as a slotted screwdriver with a 2.5 mm blade.

10.6.1 Demounting steps

NOTICE

Destruction of components due to demounting under voltage!

Before mounting or demounting components, disconnect the control - including its components - from voltage.

Removing the control from the top-hat rail

1. Remove the left end clamp.
2. Use a suitable tool (e.g. slotted screwdriver) and put it first into the upper and then into the lower disengaging mechanism (base latch) of the control and disengage the control (see (A) in the following figure). The base latches are locked in the open position.
3. Remove the control vertically to the mounting rail (see (B) in the following figure). The base latches engage again in idle position.

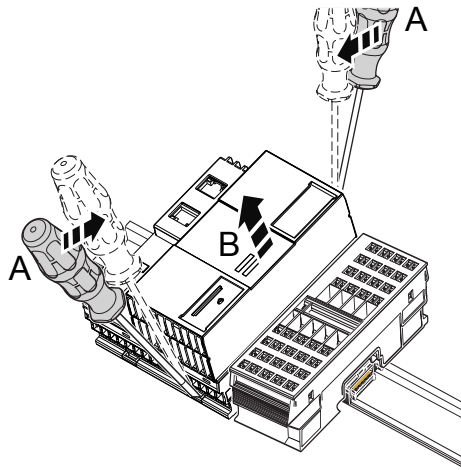

Fig. 10-11: Removing the control from the top-hat rail

The control bus base module remains on the mounting rail.

Demounting the control bus base module

1. Separate the bus base module of the control from the connection of the first S20 bus base module by moving the bus base module of the control to the left by approximately 5 mm (see (A) in the following figure).
2. Separate the bus base module of the control from the connection of the first extension bus base module by moving the bus base module of the control to the right by approximately 5 mm.
3. Use a suitable tool (e.g. slotted screwdriver) to enter into the latching on one side (see (B), (B1), (B2) in the following figure).
4. Lift up the bus base module and remove it (see (C) in the following figure).

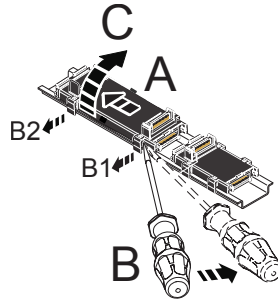

Fig. 10-12: Removing the control bus base module from the top-hat rail

10.7 Electric installation

⚠ WARNING

Danger of personal injury due to incorrect mounting or electric installation!

- Any dangerous system states, which might cause personal injury, must be prevented!
- Protection upon direct and indirect contact must be ensured by the specified measures (connection to protective conductor, insulation, etc.).

NOTICE

Danger of material damage due to incorrect mounting or electric installation!

- Any dangerous system states, which might cause material damage, must be prevented!
- Protection upon direct and indirect contact must be ensured by the specified measures (connection to protective conductor, insulation, etc.).

10.7.1 External power supply unit

⚠ DANGER

Danger of lethal injury due to hazardous electric voltage

- Connect power supply units generating protective extra-low voltage (24 V) only to supply voltages designed for these power supply units. Note the over-voltage categories (refer to the documentation of the power supply unit)
- Do not apply the supply voltage to the protective extra-low voltage

All control components are supplied from 24 V voltage supplies (SELV/PELV).

Use the Bosch Rexroth power supply unit VAP01.1H-W23-024-010-NN, part number R911171065, for the logic supply. For further information on the external power supply unit and on the creation of overvoltage categories, refer to the documentation of the power supply unit.

All lines of the 24 V voltage supply have to be routed separately from lines carrying higher voltages.

All peripherals, such as digital sensors or actuators connected to the interfaces of the control, also have to comply with the criteria of safety-separated circuits.



The same external power supply unit has to supply the 24 V voltage supply of the XMx control and the extension modules. Connect the voltage supply to the XD1 plugs of the XMxx control and then bridge the cables to the power connectors XD1 of the extension modules.



The 24 V voltage supply of the S20 I/O modules may not be branched off from the XD1 plug of the XMxx control, but with an own connecting cable to the external power supply unit instead.



The 24 V voltage supply has to be grounded. For more detailed information, refer to the documentation of the power supply unit.

10.7.2 Voltage supply for the control

The control is supplied via the XD1 plug on the lower left.



Connect the power connector with cables with a conductor cross-section of AWG 16 (1.5 mm²).



Use only copper wires to connect the connection terminals.



Use only cables approved for temperatures of at least 60°C. In case of ambient temperatures above 55°C, use cables approved for temperatures of at least 75°C.



Observe the color-coding of the plugs.



Only the "XA-CN01" power connector is permitted to connect the 24 V supply voltage for the IndraControl XM21/XM22 control (see [chapter 5.1 "Power connectors, 24 V" on page 5](#)).



If multiple XM2x controls (24 V supply voltage U_{LS}) are connected parallelly to a central 24 voltage supply, ensure that the 0 V connection of the U_{LS} is wired without interruption to all XM2x controls.

If this is not observed, XM2x might become defective.

Power connector XD1

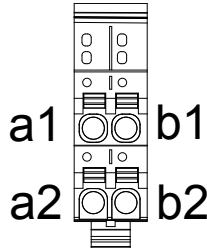

Fig. 10-13: Power connector XD1

Connector contact	Signal	Function
a1, a2	24 V	+24 V DC supply voltage (U_{LS})
b1, b2	0 V	GND (U_{LS}) (ground supply voltage)

Tab. 10-1: Pin assignment of the power connector XD1



In the power connector, the contact a1 is bridged with a2 and the contact b1 is bridged with b2. The control is set up to connect to a UPS in future variants. Thus, 2A is labeled with "UPS". However, a UPS can only be used without bridges when a respective variant and a specific power connector are used.

10.7.3 24 V voltage supply

The voltage of 24 V can be supplied with or without electrical isolation.

Setup without electrical isolation

An easy connection method is the setup without an electrical isolation between the internal logic and the peripheral supply.

In this case, a power supply unit is sufficient to supply the control.



The GND (U_{LS}) is grounded in the device!

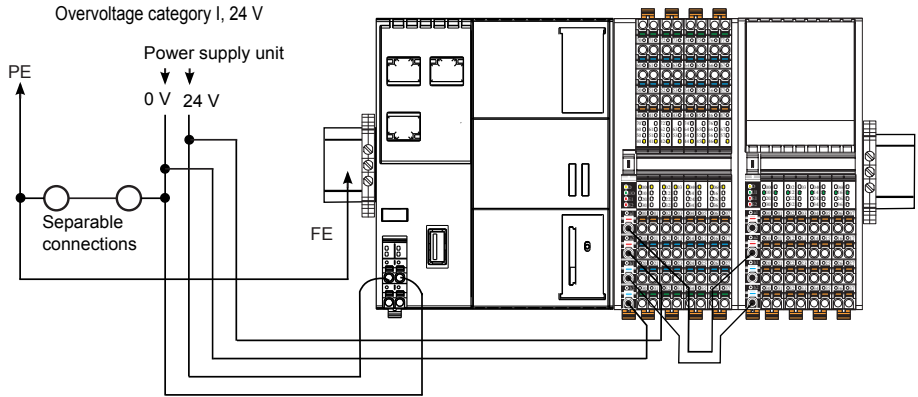

Fig. 10-14: Setup without electrical isolation



Control does not start in case of reverse input voltage

The feeding of 24 V at the XD1 connector is protected against polarity reversal. A polarity reversal of U_{LS} and GND feeding does not damage the device. However, the control does not start and the U_L LED is not on.

Reference conductor connected to the protective conductor and set up with electrical isolation

Provide electrical isolation between the logic of the central processing unit and the I/O interfaces of the peripheral component groups according to DIN EN 60204-1. Accordingly, the voltage U_{LS} (24 V logic voltage) at the control is electrically isolated from the supply voltage for the I/O modules.

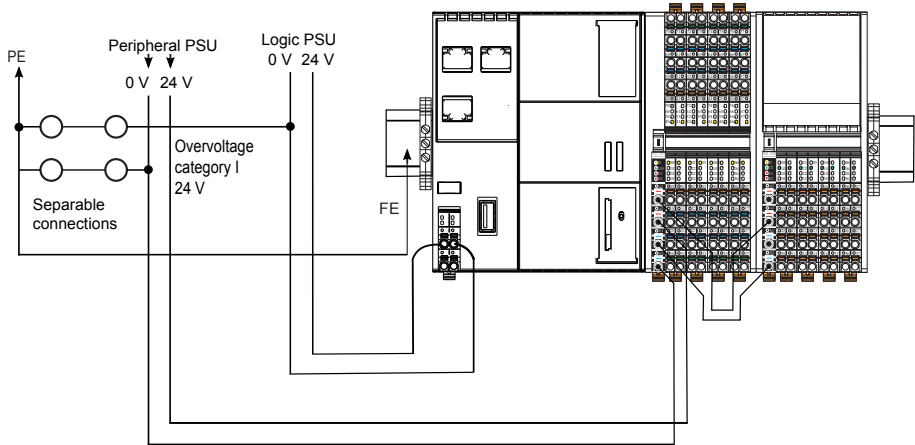

Fig. 10-15: Reference conductor connected to protective conductor

Dimensioning the voltage supply

Observe the maximum currents when dimensioning the voltage supply. The operating voltage allowed has to be applied directly to the device.

The voltage must also not be exceeded if:

- there are variations in line voltage, e.g. caused by different loads of the mains
- there are varying load states, such as short-circuit, normal load, lamp load or no load

Connecting the reference conductor to the protective conductor

If the reference conductor 0 V (U_{LS}) is connected to the protective conductor system, this connection has to be arranged at a central place (e.g. at the load power supply unit). Hence, the supply current circuit is a PELV circuit.

10.7.4 Grounding

NOTICE

Control failure due to insufficient grounding

An optimum grounding is required to keep away possible interferences from the control and to discharge them to the ground.

Functional earth



Only the functional earth (FE) is used for the XM2x controls, extension modules and the S20 components. The functional earth is only used to discharge disturbances. The functional earth is not provided as a protection against electric shock for persons.

The control is grounded via the top-hat rail. The top-hat rail, on which the control is mounted, has to be mounted to a grounded metal carrier, e. g. the rear panel of the control cabinet.

The XM2x control and the S20 I/O modules are provided with FE springs (metal clips) at their bottom side creating an electric connection to the mounting rail while mounting.

If necessary, provide the top-hat rail with a separate grounding connection.

Potential equalization

Potential equalization acc. to DIN VDE 0100 part 540 has to be provided between the system parts and the voltage supply.

10.7.5 Shielding

NOTICE

Control failure due to insufficient shielding

Provide sufficient shielding.

The shielding reduces any effects of interferences on the system.

Observe the following when shielding:

- Fasten the shielding as extensively as possible
- Ensure proper contact between connector and terminal
- Avoid damaging or squeezing conductors
- Note the wire specifications when connecting the shielding
- Shield the closest possible to the signal terminal points



Route all power cables and data cables in separate cable channels.

11 Commissioning

11.1 Commissioning steps

To commission the device, proceed as follows:

1. Mount the control.

For details, refer to [chapter 10 "Mounting, demounting and electric installation" on page 16](#).

2. Connect the voltage supply to the XD1 connection of the control.
Refer to [chapter 10.7.2 "Voltage supply for the control" on page 25](#).
3. Switch on the control → The initial firmware starts.

Refer to [chapter 12.2.3 "Starting and opening the initial firmware" on page 40](#).

4. Install the system firmware. There are two options:
 - Via IndraWorks (refer to the functional description of the respective system (IndraMotion MLC, IndraMotion MTX)
 - Via the initial firmware (refer to [chapter 12.2 "Initial firmware" on page 38](#)).
5. Start the commissioning tool "IndraControl First Touch" and make the corresponding settings (IP address, subnet mask, gateway address).
Refer to [chapter 12.5 "IndraControl First Touch" on page 43](#).

NOTICE

Control malfunction due to control switch-off during initialization

Note that hardware is initialized after switching on the control and after installing the system firmware with subsequent reboot. An internally programmable function block is loaded. After loading, the LED display "ON" at the voltage plug is green.

Wait till completion. Do not switch off the control. This procedure has to be completed. Subsequently, continue the commissioning.

11.2 Establishing a connection to the engineering PC via the USB device interface "XF31"

Instead of using the Ethernet interface "XF5" to commission the control or to use the commissioning tool "IndraControl First Touch", use the connection **XF31**. Connect the USB interface of your computer to the USB device connection "XF31" via a common USB data and charging cable. Upon the initial connection, the respective device driver (USB Remote NDIS) is installed on the PC.

Even though the computer and the control communicate via Ethernet, it is only a point-to-point connection.



The IP address of the connection "XF31" on the control is 192.168.234.234.

The IP address cannot be changed.

If the RNDIS device driver is not installed automatically, install it manually:

1. Open the "Device manager" in the Windows "System control" (under **System and security** ► **System** ► **Device manager**).
2. The entry "RNDIS/Ethernet gadget" is displayed in the list under "Other devices".
3. Select "Update driver software ..." in the context menu of "RNDIS/Ethernet gadget".

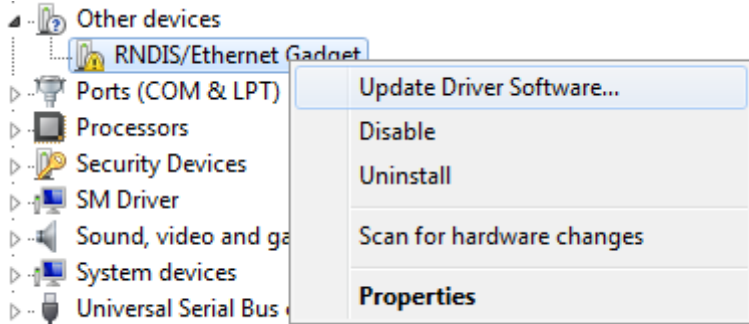

4. In the dialog, select the entry: "Browse my computer for driver software".

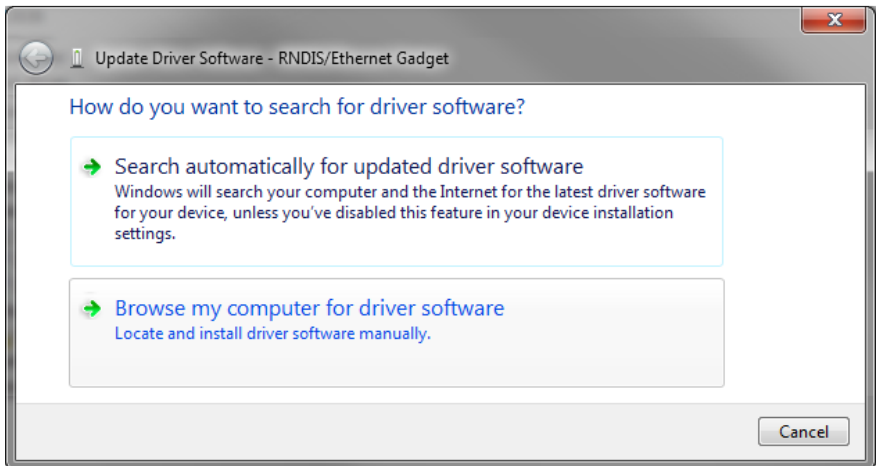

5. In the dialog, select the entry: "Let me pick from a list of device drivers in my computer".

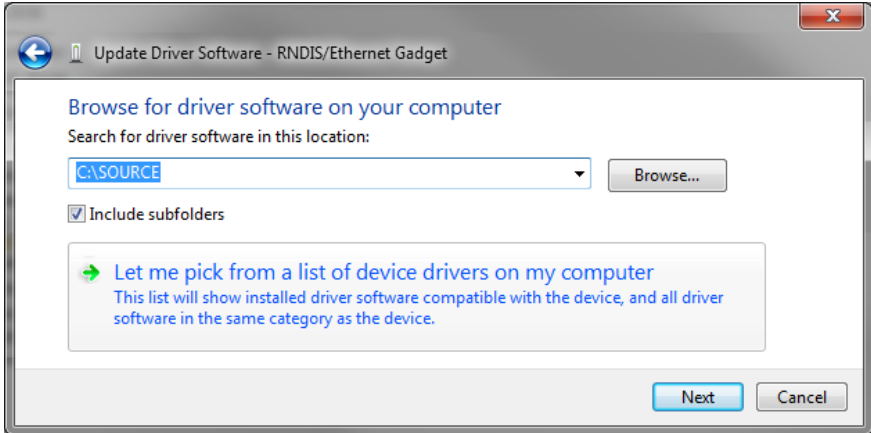

6. In the dialog, select the entry: "Network adapters".

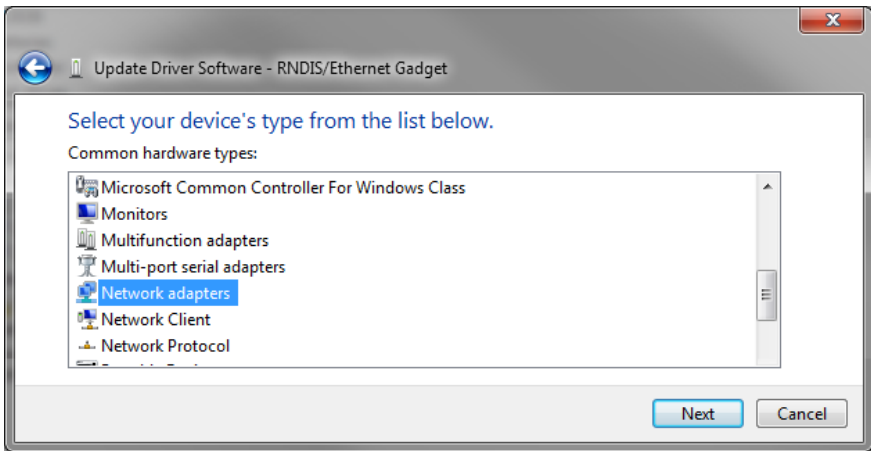

7. Select the entry "Microsoft corporation" under "Manufacturer". Then, select "Remote NDIS compatible device" under "Network adapter".

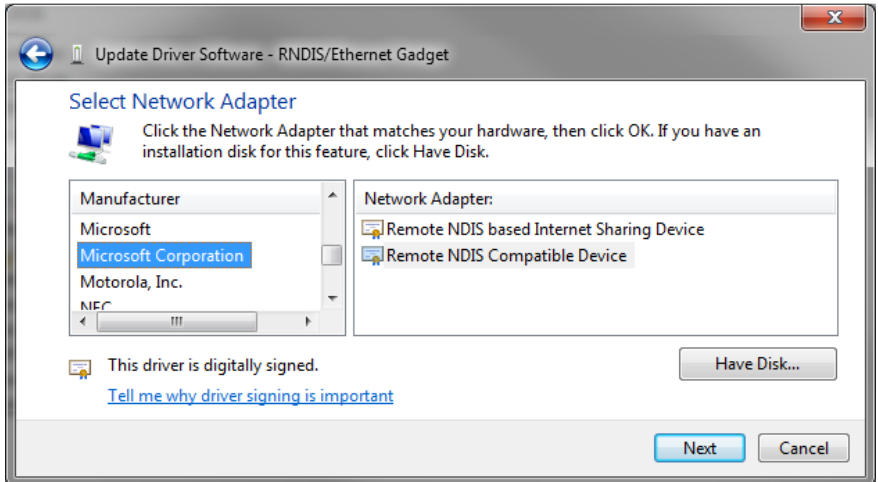

8. To confirm the installation, click on "Yes".

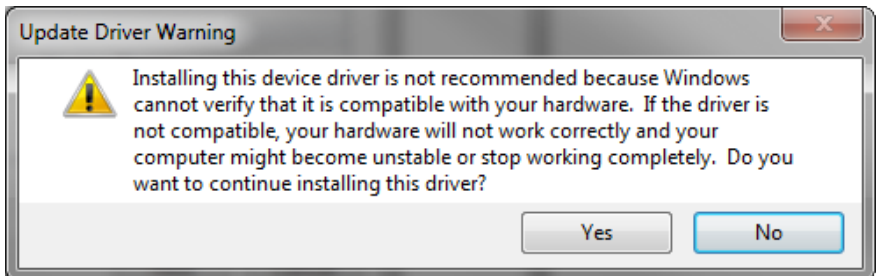

9. After a successful installation, the following message is displayed:

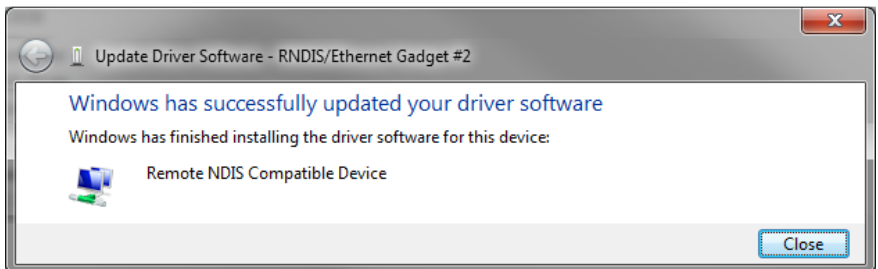

12 Device description

The XM2x controls are compact controls in the medium-performance range with integrated interfaces of Ethernet, Sercos and S20 local bus.

The XM2x controls are designed for a fast processing of control tasks. The XM2x controls are configured and programmed with the engineering platform "IndraWorks". The XM22 controls can be networked via the Ethernet interface and connected to the drive modules via the Sercos interface. The XM2x controls can be extended for various control tasks using S20 modules and extension modules.

12.1 LEDs and operating elements

To operate and for the error diagnostics, there are multiple PEDs, an operation mode switch and a "Reset" button on the front side of the IndraControl XM21/ XM22 control.

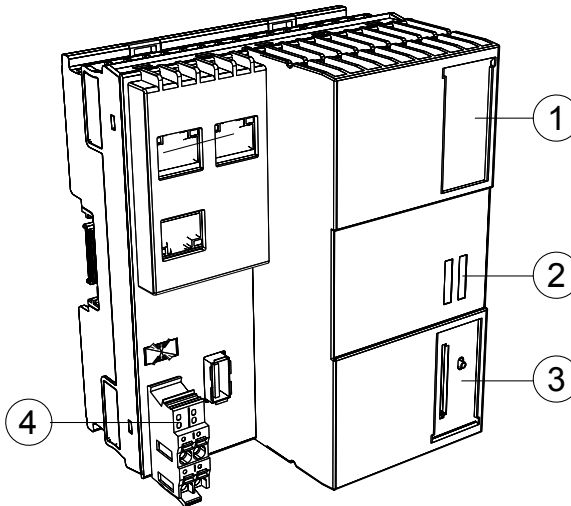

- ① Reset button (behind sliding plate)
- ② LED display, block of 10
- ③ Operation mode switch SF1
- ④ LEDs on power connector XD1

Fig. 12-1: LED and operating element positions

12.1.1 LEDs in the XD1 plug

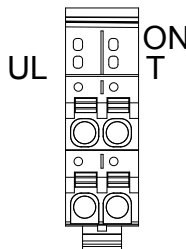

Fig. 12-2: LEDs on the XD1 plug

The following functions are assigned to the LEDs on the XD1 plug:

LED	Color	Function
U _L	Green	24 V supply voltage connected and within the permitted range
ON	Green	All internally programmed function blocks are loaded. These also include internally programmed function blocks of connected modules. If this LED is not green, loading for internally programmed functions block of an extension module or of the control failed. In this case, initiate a fallback. Refer to chapter 12.4 "Fallback and recovery" on page 42 .
T	Red	<ul style="list-style-type: none"> The temperature is critical If the control cannot be operated anymore, the maximum temperature was exceeded and the control was switched off. The control can only be operated when interrupting the voltage.

Tab. 12-1: LED functions on the XD1 plug

12.1.2 LED block of 10

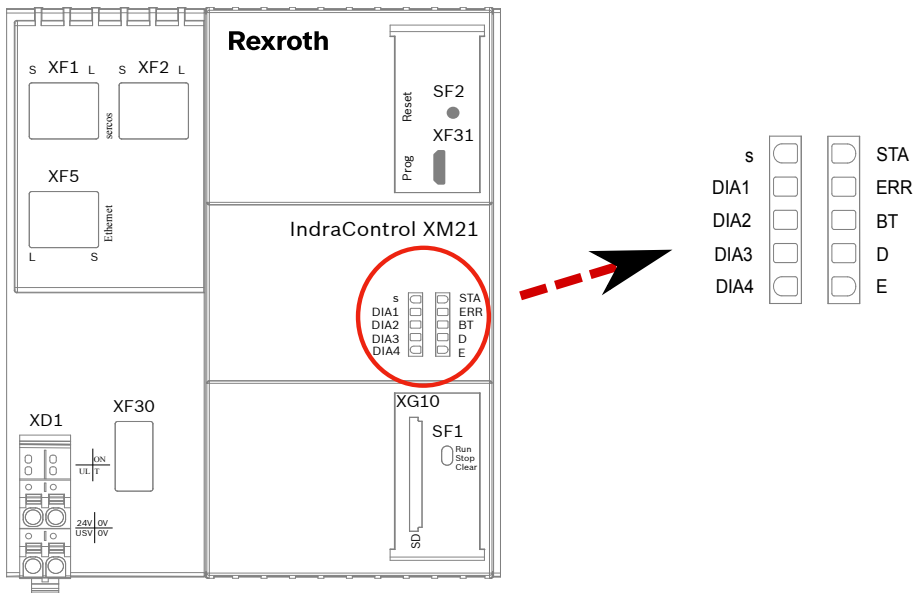

Fig. 12-3: LED block of 10

The LED block of 10 is positioned on the higher located area of the control housing.

The following functions are assigned to the LEDs at running system firmware:

LED	Color	Function
s	Red/orange/green	Sercos status
DIA1	Red/orange/green	Used as feedback for the operation mode switch
DIA2	Red/orange/green	Basic diagnostics by the system
DIA3	Red	Currently booting
DIA4	Red	Currently booting
STA	Red/orange/green	STOP/READY/RUN
ERR	Red/orange/green	Error status (warning, error)
BT	Red/orange/green	Boot status
D	Red/orange/green	Onboard S20: Diagnostics S20 bus
E	Red/orange/green	Onboard S20: Error or warning of S20 devices

Tab. 12-2: LED block of 10



The displayed device states are firmware-dependent and described in the functional description of the respective control system (Rexroth IndraLogic XLC IndraMotion MLC 14 VRS, Functional Description, [R911341700](#)).

12.1.3 Operation mode switches

The operation mode switch is positioned on the higher located area of the control housing.

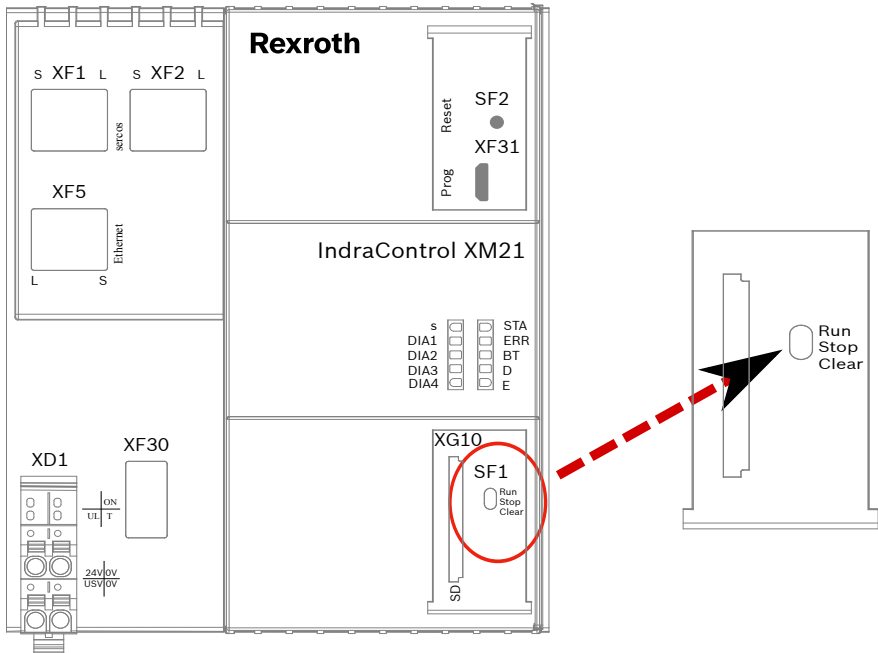

Fig. 12-4: Operation mode switch

The operation mode switch has three positions:

Switch position	Function ^①	Property
Up	Run	Engaged
Center	Stop	Engaged
Down	Clear	Sampling

① Refer to the functional description of the respective control system (Rexroth IndraLogic XLC IndraMotion MLC 14 VRS, Functional Description, R911341700)

12.1.4 Reset button

The "Reset" button is positioned on the higher located area of the control housing.

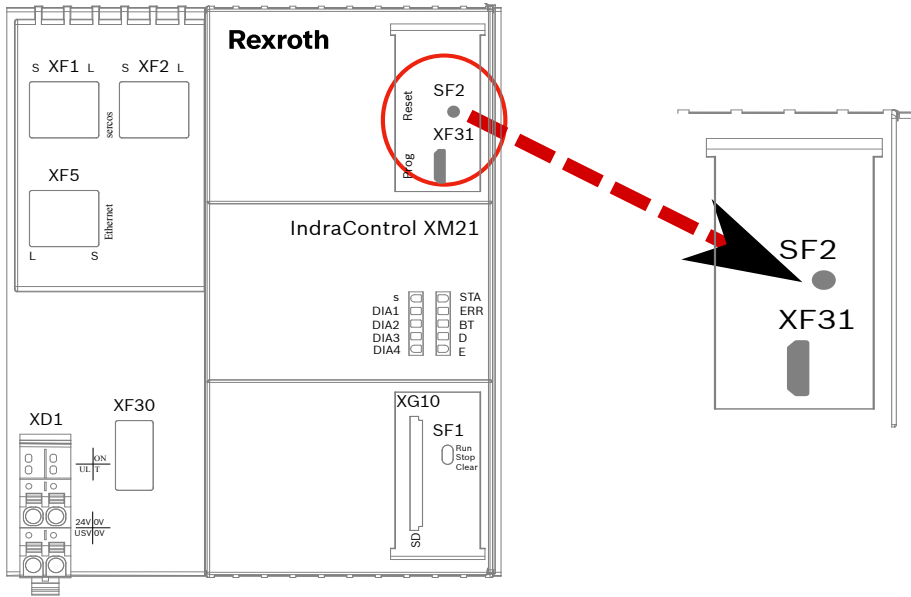

Fig. 12-5: Reset button

Press the "Reset" button at running control to trigger a voltage cycle (reset).

The "Reset" button is provided with two functions triggered when the reset button is pressed while applying the supply voltage:

- Press the "Reset" button < 5 seconds: Triggering the fallback mode (see [chapter 12.4 "Fallback and recovery" on page 42](#))
- Press the "Reset" button > 5 seconds until the LEDs DIA3 and DIA4 flash alternately: Triggering the initial firmware (see [chapter 12.2 "Initial firmware" on page 38](#))



The "Reset" button can only be actuated with a sharp tool (e. g. pencil).

12.2 Initial firmware

The initial firmware provides commissioning and maintenance functions. Basic functions can be activated manually without any additional tools. The IndraControl XM21/XM22 provides a simple interface with its operation mode switch SF1 and the LED display panel.

The commissioning tool "IndraControl First Touch" (see [chapter 12.5 "IndraControl First Touch" on page 43](#)) provides comfortable functions. If connected to a PC, it can be opened with a web browser. The comprehensive mechanisms for commissioning with the IndraWorks Suite are also supported by the XM2x control.

12.2.1 License information

To open the license conditions, select the directory "/INITFW/Licenses/" in the file manager of the web application "First Touch".

This product contains software components that are licensed by the holder of the rights under GNU General Public License (GPL), GNU Lesser General Public License (LGPL) or any other Open Source Software license, which requires that source code be made available.

The source code of these software components is not already delivered together with this product. You can obtain the source code for these software components on a physical medium (CD or DVD) by submitting a written request to our open source office address listed below or by sending an email to open.source@boschrexroth.de. When sending such a request, please name the relevant product and the date of purchase of the same.

Bosch Rexroth AG

Open Source Office

Zum Eisengießer 1

97816 Lohr am Main

Deutschland

We may charge you a fee (up to max. 20,- €) to cover the cost of physical media and processing.

You may send your request (i) within three (3) years from the date you received the product that included the binary that is the subject of your request or (ii) in the case of code licensed under the GPL v3 for as long as Bosch Rexroth offers spare parts or customer support for that product.

12.2.2 LED states

For the initial firmware, the LEDs indicate the following function states:

LED	Function	Color	Status
DIA2	Store core dump on the SD card or on a USB medium (for diagnostic purposes)	Green/orange flashing	In process
		Green	Done
		Red	Error
DIA3, DIA4	Operating system state	Alternatingly red flashing	Initial firmware is active
ERR	Reset to delivery state	Red	Function selected, processed
		Flashing red	Confirm selection
BT	Reset user name and password	Red	Function selected, processed
		Flashing red	Confirm selection
D	Delete network configuration	Red	Function selected, processed
		Flashing red	Confirm selection

LED	Function	Color	Status
E	Start First Touch	Red	Function selected/processed
		Flashing red	Confirm selection
		Green	First Touch running

Tab. 12-3: LED states



The LED states described are only valid together with the initial firmware.

For more information on the LED states in operation, refer to the functional description of the respective control system (IndraMotion MLC, IndraMotion MTX).

12.2.3 Starting and opening the initial firmware

No system firmware is yet installed on the XM2x control upon delivery. Apply the supply voltage and the control starts the initial firmware. Subsequently, open one of the following functions via a menu structure:

Menu item number	Functions	LED	Color
1	Start First Touch	E	Red
2	Start First Touch, delete network configuration	E	Red
		D	Red
3	Start First Touch, delete network configuration, reset user name/password	E	Red
		D	Red
		BT	Red
4	Start First Touch, delete network configuration, reset user name/password, delete files → Factory reset	E	Red
		D	Red
		BT	Red
		ERR	Red

Tab. 12-4: Menu items of the initial firmware



If the function was executed successfully, the LED "E" changes from red to green after some seconds.

The control must not be switched off during this time.

The operation mode switch SF1 provides the following options to open the menu items:

1. Press SF1 < 3 seconds to the position "Clear": Menu item navigation and selection.

Whenever SF1 is pressed, the next menu item is selected. (1 > 2 > 3 > 4 > 1 ...)

2. Press SF1 > 3 seconds to the position "Clear": Triggering the menu item function.

The LED "E" changes from red to green.

Triggering the function is displayed by a brief switch-off and switch-on of the respective LEDs.

3. To confirm the "Factory reset" (menu item no. 4), the operation mode switch SF1 has to be set to the "Run" position.

The left column is flashing until the additional confirmation of the operation mode switch is on the "Run" position. The process of restoring the state upon delivery is displayed by a running down of the right LED column. The completion of the restoration is displayed with a green LED "E". The device must not be separated from the voltage supply during that time.



When selecting menu item 4 "Factory reset", all files on the XM2x control installed since the commissioning are deleted. We recommend to create a system firmware backup (see [chapter 12.5.3 "Firmware management" on page 45](#)) before using this function. The initial firmware is part of the hardware and not deleted.



After the system firmware has been loaded successfully, the control does not boot the initial firmware anymore. To call the initial firmware again, press the "Reset" button when switching on the 24 V supply voltage until the LEDs DIA3 and DIA4 flash alternately in red.

12.2.4 Installing a backup from an external SD card

If the control is as in delivery state, a backup can also be loaded to the control without PC. Proceed as follows:

1. Copy a valid control backup to a Bosch Rexroth SD card (part no. 1070925435). Use either a PC with SD card reader or the file manager of the First Touch commissioning tool.
2. Rename the image file to "system.fw".
3. Plug in the SD card to the base of the XM2x control labeled with "SD".
4. Switch on the 24 V supply voltage.
5. The initial firmware automatically starts the installation of the backup on the control. While installing, the "ERR" LED is orange. After successful installation, the "ERR" LED is off and the "E" LED is green.
6. Reboot to start the control with system firmware.

The installation can be facilitated together with the "Backup system firmware" function (see [chapter 12.5.3 "Firmware management" on page 45](#)).

12.3 Booting

The control starts booting after switching on the 24 V voltage supply. Booting can be monitored and checked using different LEDs.

The following boot sequence is defined:

1. The LED "U_L" at the 24 V plug is green if 24 V is connected.
2. The LED "ON" at the 24 V plug is green if the programmable logic is properly loaded.
3. The LEDs "DIA3" and "DIA4" in the LED block of 10 flash alternately in red while booting.
4. The LEDs "DIA3" and "DIA4" in the LED block of 10 go off after booting and when the operating system is running.



If it is not booted in this sequence, an error is present (see [chapter 13 "Error causes and troubleshooting" on page 53](#)).

12.4 Fallback and recovery

The hardware is initialized after switching on the control and after installing the system firmware with subsequent reboot. Internally programmable function blocks are loaded. These also include internally programmed function blocks of connected modules. After the loading, the display LED "ON" at the voltage plug is green.

Wait till completion. Do not switch off the control. This procedure has to be completed.

If this display LED "ON" is not green, loading for internally programmed functions block of an extension module or of the control failed. The display LED "ON" of the control is a collective display for all connected modules and the control.

In this case, trigger the "Fallback mode":

1. Switch off the 24 V voltage supply for the XM2x control and of the extension modules.
2. Keep the "Reset" pushbutton "SF2" at the XM2x control pressed and switch on the 24 V voltage supply. If either the display LED DIA3 or the LED DIA4 is on at the XM2x control, release the "Reset" button "SF2".

If the display LED "ON" at the control XM2x is on, the error is eliminated.

If the display LED "ON" at the control XM2x is not on, initiate the "Fallback mode" for the extension modules, whose display LED "ON" is not on.

3. Keep the "Fallback" pushbutton of the respective module pressed using a plastic pen until the display LED "ON" at the extension module is on. This loads a backup data set. Release the "Fallback" pushbutton. Perform this step subsequently for all extension modules. First at those, whose display LED "ON" was not on. After completing that for all extension modules, the display LED "ON" of the XM2x control has to be on.



The XM2x control can only start if all connected extension modules started without any errors. If the LED "ON" of a connected extension module is not green, initiate the "Fallback" mode for this extension module.

12.5 IndraControl First Touch

The "IndraControl First Touch" commissioning application interactively commissions and maintains controls of the IndraControl XM generation. The commissioning application can be reached via the IP address of the control and can run on most of the current web browsers. To open the setup application, enter the following IP addresses:

- The IP address of the connection XF1 (Ethernet interface) on the control is 192.168.234.234 upon delivery. This IP address can be changed.
- The IP address of the connection XF31 (USB device interface) on the control is 192.168.234.234. This IP address cannot be changed.



The "IndraControl First Touch" commissioning tool is only available in English.

Supported web browsers:

- Chrome 3+
- Firefox 9+
- Internet Explorer 10+

The First Touch website communicates via the encrypted https protocol. Enter the URL (<https://192.168.1.1/> or <https://192.168.234.234>) and then confirm the security certificate before the website is loaded.

After loading the First Touch website, a "Welcome" page is displayed. For all other functions and the navigation to another First Touch site, a user login is required. To log in, enter user name and password into both the form fields of the navigation bar.

The default user ID is:

- User name: boschrexroth
- Password: boschrexroth

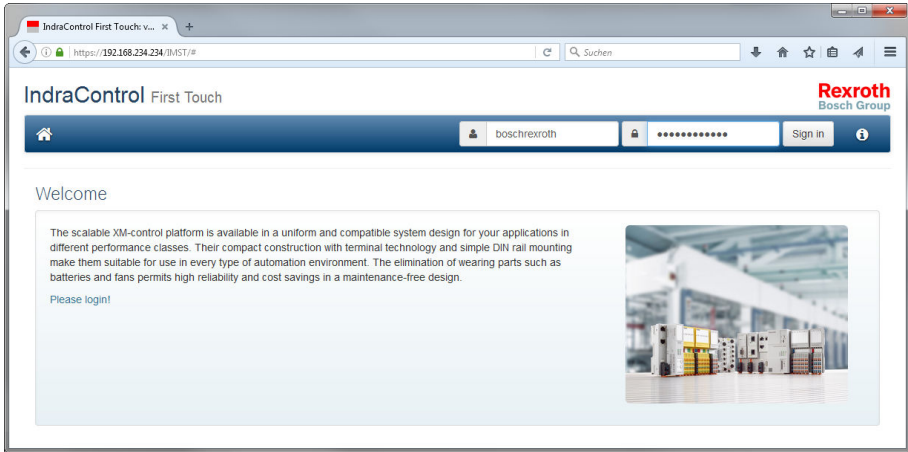

Fig. 12-6: "Welcome" dialog

12.5.1 Hardware data

The "Hardware" site lists all device-specific data of the XM12 control in a table.

- Material index
- Hardware type plate
- Serial number
- Part number

12.5.2 Network settings

The "Network" site is used to configure the network settings during the initial commissioning. The currently configured network settings are shown in the following three fields and can also be changed using these fields:

- IP address
- Gateway
- Subnet mask

Enter a valid network setting and write that setting to the control (press the **Write configuration** button). If writing the network settings is completed successfully, a message is displayed in the header area of the site. The **Reboot control** button is additionally displayed. It is used to restart the control and thus applies the network setting.

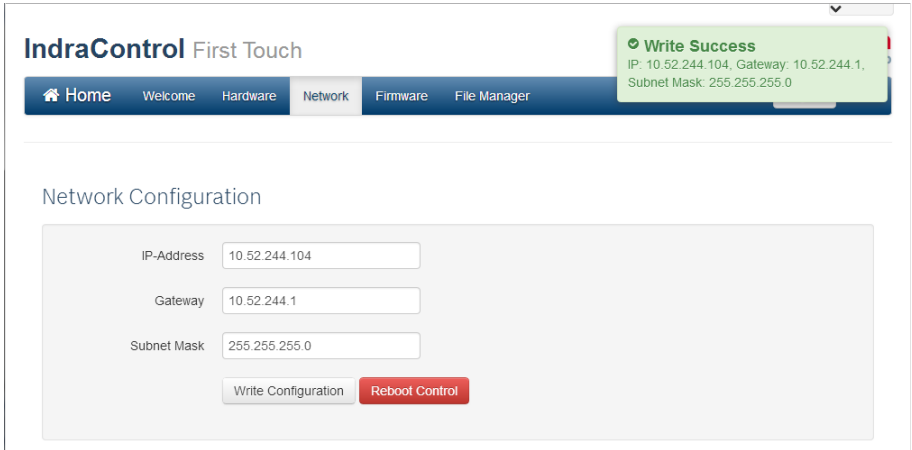

Fig. 12-7: "Network configuration" dialog



The network settings are only applied after a control restart.

12.5.3 Firmware management

The "Firmware management" site provides the following information:

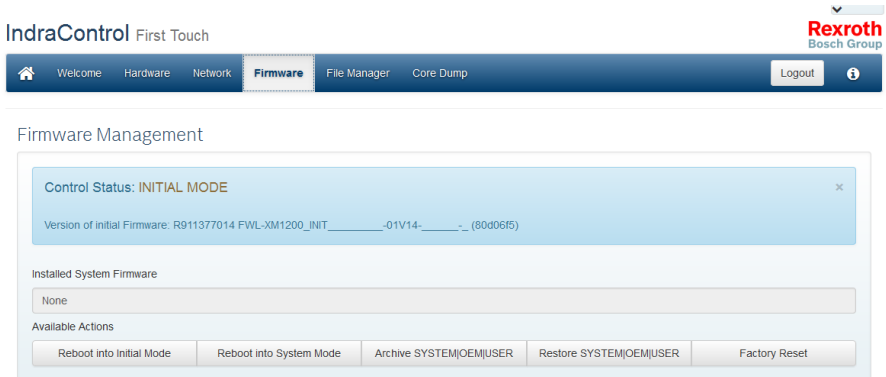

Fig. 12-8: "Firmware management" dialog

- Current control mode:
 - Initial mode: Initial firmware is loaded or active (initial firmware is shown in the message window)

- System mode: Control was started with the previously installed system firmware
- Installed system firmware version ("none" if no system firmware was installed)

Press the buttons for the following actions:

- Reboot into "Initial mode": Reboots the system and restarts the initial mode
- Reboot into system mode: Boots an installed system firmware
- Archive SYSTEM|OEM|USER: Backs up the complete directory structure of all partitions to a firmware archive (.fw file), also refer to [chapter "Archive SYSTEM|OEM|USER" on page 46](#)
- Restore SYSTEM|OEM|USER: To restore a system installation from a backup file, also refer to [chapter "Restore SYSTEM|OEM|USER" on page 48](#)
- Factory reset: Restores the delivery state of the control. The complete directory structure is reset



Caution: Loss of data!

An existing system firmware installation is deleted. The network settings are reset to its delivery state.

Archive SYSTEM|OEM|USER

This function is used to archive the internal storage medium. This includes all partitions and their file and directory structure. After the process, an ".fw" file is stored on the user partition of the control. This file can be loaded to a local PC at a later point in time (see [chapter 12.5.4 "File manager" on page 50](#)).



The file name of a system archive can consist of 4-16 alphanumerical characters and has to have the file extension ".fw".

The backup can only be started if the selected file name corresponds to the archive rules. During as well as after the backup, a corresponding message is displayed.



Archive SYSTEM|OEM|USER

Select Target Directory

/USER/

Filename

mySystemArchive.fw

Archive SYSTEM|OEM|USER Please wait...

Close Archive

Fig. 12-9: Dialog "Archive SYSTEM|OEM|USER"

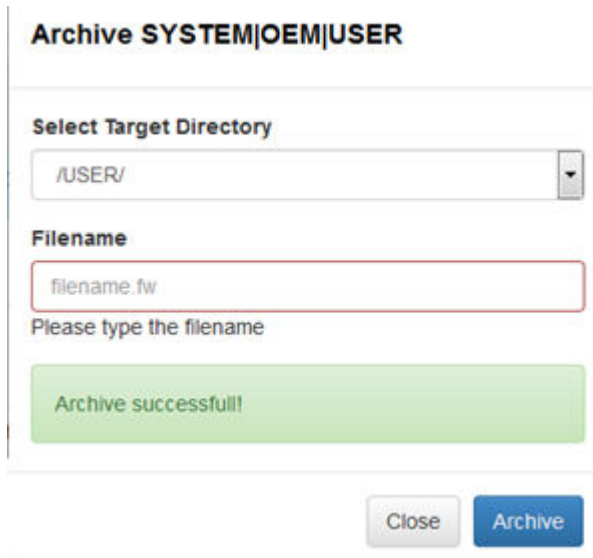

Archive SYSTEM|OEM|USER

Select Target Directory

/USER/

Filename

filename.fw

Please type the filename

Archive successfull!

Close Archive

Fig. 12-10: Dialog "Archive SYSTEM|OEM|USER" – Successfully completed

Restore SYSTEM|OEM|USER

If the action "Restore SYSTEM|OEM|USER" is selected, a modal dialog to select a system firmware file opens. The file can either be selected from the local file system or the user partition of the control. If the file is selected from the local file system, the archive is installed in two steps:

1. Transferring the file to the control
2. Installing the archive

Restore SYSTEM|OEM|USER

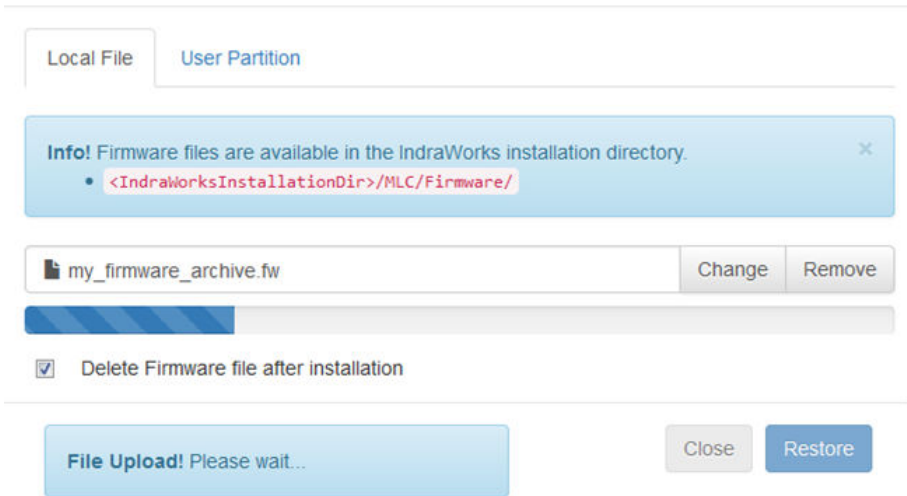

Fig. 12-11: Dialog "Restore SYSTEM|OEM|USER" – Upload

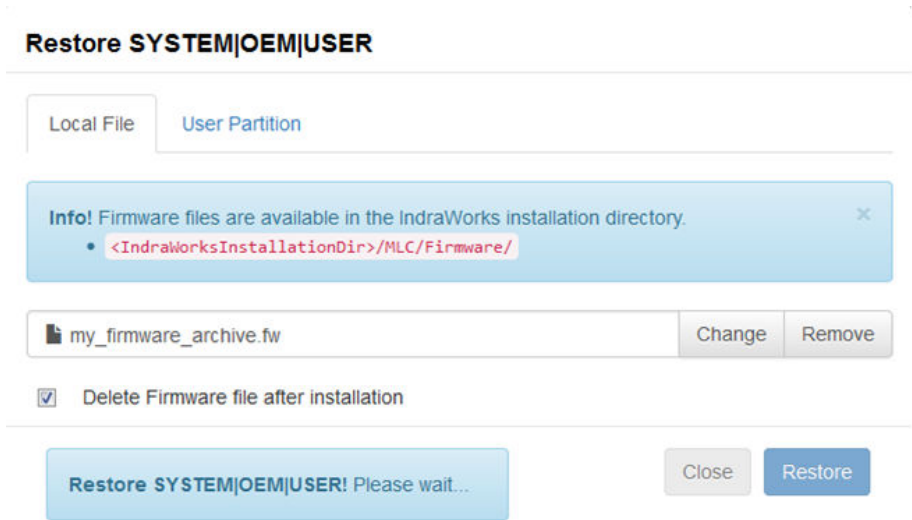

Fig. 12-12: Dialog "Restore SYSTEM|OEM|USER" – Installation running

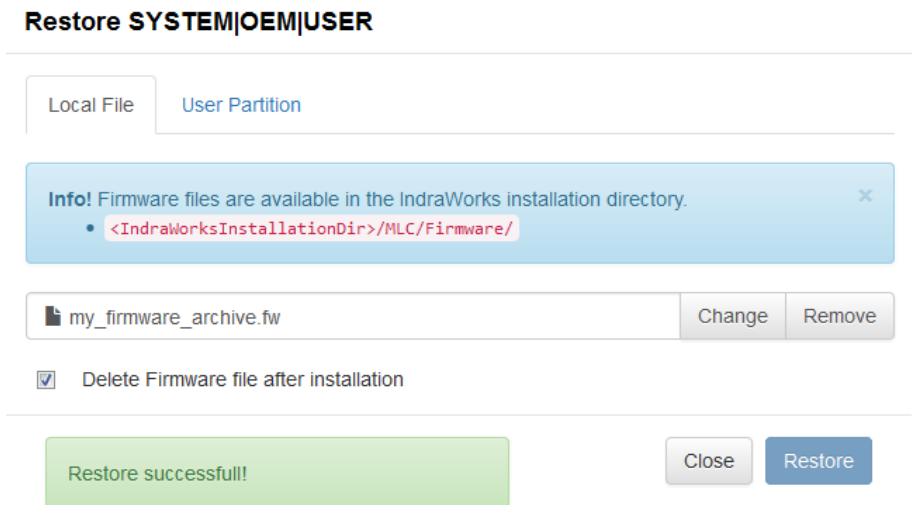

Fig. 12-13: Dialog "Restore SYSTEM|OEM|USER" – Successfully completed

The "User partition" tab lists all archive files found in the root directory of the user partition. For the installation, select the respective archive file. Click on the "Restore" button to start the installation.

Restore SYSTEM|OEM|USER

Local File

User Partition

Name	Modified	Size
my_firmware_archive.fw	25-Nov-2016 12:57	16074.65 kb
my_firmware_archive_25112016.fw	25-Nov-2016 13:23	16074.65 kb

Close
Restore

Fig. 12-14: Dialog "Restore SYSTEM|OEM|USER" – From the user partition

12.5.4 File manager

The following actions can be executed using the file manager:

- Browse through the directory structure (click on a directory name)
- Transfer files from the control to the client (click on a file name)
- Transfer files from the client to the control (action: Upload file)
- Create directories (action: Create directory)
- Delete (empty) directories (click on the "Delete" icon in the table row)
- Delete files (click on the "Delete" icon in the table row)

IndraControl First Touch
Rexroth
Bosch Group

Home
Welcome
Hardware
Network
Firmware
File Manager
Core Dump
Logout
?

File Manager

ROOT / OEM
Action ▾

Name	Modified	Size	
licenses/	25-Nov-2016 12:40	[DIRECTORY]	🗑️
ProjectData/	25-Nov-2016 12:33	[DIRECTORY]	🗑️
ProjectDataProtected/	25-Nov-2016 13:25	[DIRECTORY]	🗑️

Fig. 12-15: "File manager" dialog

12.5.5 Core dump

In case of a system error, the control can create a complete core dump of the system that can be provided for an error analysis. IndraControl First Touch supports two use cases with this functionality:

1. Transfer of the active core dump from the control to the user PC.

All files assigned to the active core dump are displayed with name and file size in the "Core dump" menu item. Click on the file name to transfer the files to the user PC via the browser-specific download dialog.

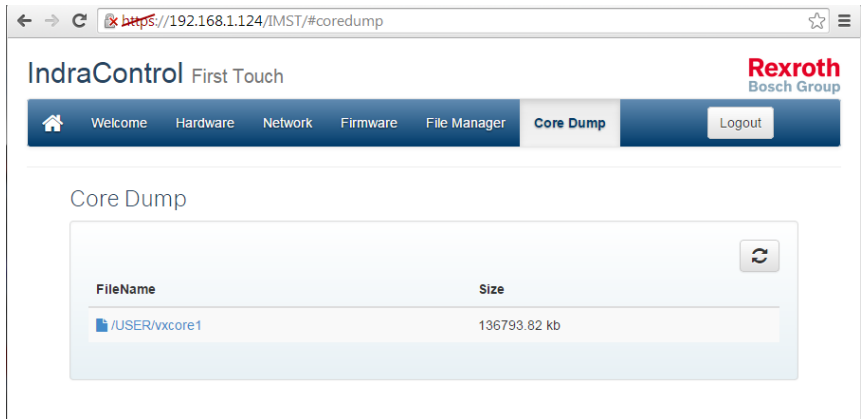

Fig. 12-16: Displaying the active core dump in IndraControl First Touch

2. Support of the user if the core dump could not be saved in the file system of the control (e.g. not sufficient free memory space available).

The user can now release storage space in the default target directory for core dump files (/USER/). Use the "File manager" menu item. An additional data carrier (e.g. USB stick) can also be connected to the control. In both cases, saving the core dump has to be restarted. First Touch provides a dialog in the "Core dump" menu item. This dialog allows to select the target directory if unsaved core dump files are available in the RAM of the control.

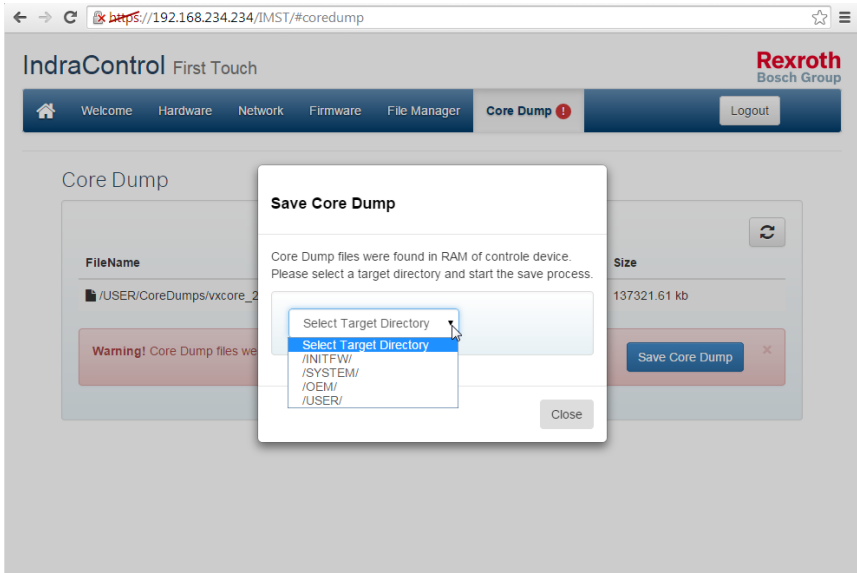

Fig. 12-17: Selecting the target directory to save the core dump

After selecting a valid target directory, press **Save** to start saving the core dump. If saving was successful, a corresponding status message is shown. The dialog can now be closed. After closing the dialog, the core dump is displayed with its respective data.

12.6 Backing up remanent data

128 KB of remanent data is automatically backed up in an internal flash memory after a 24 V supply voltage failure and restored at control startup.

12.7 Real-time clock

The real-time clock of the control is buffered in the switched-off state. The buffer capacitor loses efficiency when operated permanently at high temperatures. The buffer time of the real-time clock depends on the ambient temperature and the operating time of the control.

Operating time of the control at ambient temperature	Buffer time of the clock ^①
5 years at 50 °C permanent	Typ. 10 days
7 years at 50 °C permanent	Typ. 7 days
10 years at 50 °C permanent	Typ. 4 days
2.5 years at 60 °C permanent	Typ. 10 days

Operating time of the control at ambient temperature	Buffer time of the clock ^①
3.5 years at 60 °C permanent	Typ. 7 days
5 years at 60 °C permanent	Typ. 4 days

① Accuracy of ± 1 s/d at 25 °C

Tab. 12-5: Buffer time of the real-time clock depends on the ambient temperature and on the operating time of the control
It is recommended to set the time via SNTP.

13 Error causes and troubleshooting

The following table describes the LEDs on the power connector.

LED	LED display	Error causes and troubleshooting
U _L	LED is off	24 V voltage error 24 V supply voltage is not connected 24 V supply voltage is connected with reverse polarity
ON	LED is off	Error when loading the programmable logic Initiate fallback mode (see chapter 12.4 "Fallback and recovery" on page 42)
T	LED is red	Temperature error Control was switched off due to overheating. <ul style="list-style-type: none"> ● Ensure a lower ambient temperature ● Check the control installation ● Avoid heat accumulation impeding the natural convection

Tab. 13-1: LEDs in the voltage power connector
Further operating displays and error displays are located on the individual modules and terminals. For information on the other displays, refer to the manual of the IndraControl S20 component (see also [chapter 1.3 "Related documents" on page 2](#)).

Errors	Actions for troubleshooting
The engineering PC cannot reach the XM2x control via the USB device interface "XF31"	<ul style="list-style-type: none"> ● Check whether the device driver was correctly installed in the "Device manager" of the system control. The entry "RNDIS" is displayed under "Network adapters". If the entry is not displayed, install the driver manually, refer to chapter 11.2 "Establishing a connection to the engineering PC via the USB device interface XF31" on page 30 ● Check whether the operating system assigned a valid IP address and a subnet mask to the network adapter "RNDIS" (e.g. via the command "ipconfig"). If this is not the case, configure the IP address and the subnet mask manually.

Tab. 13-2: Error causes and troubleshooting



Repairs at the device by the customer are not permitted. Exceptions are maintenance works listed in the chapter "Maintenance".

For further information in the event of repair, please contact the Bosch Rexroth Service.

14 Maintenance

NOTICE

Maintenance work in the device is only permissible by skilled staff!

If hardware or software components have to be exchanged, please contact the Bosch Rexroth Service or ensure that only skilled staff changes the respective components.

14.1 Regular maintenance tasks

Include the following tasks into the maintenance schedule:

- Check all plug and terminal connections of the components for proper tightness and possible damage at least once a year
- Ensure that cables are not broken or crushed
- Replace damaged parts immediately

15 Ordering information

The XM2x controls can be delivered including the Motion Logic functions. The function packages are implemented into the control according to the system functions required in the application. Thus, variants with individual ordering information result from the required functional scope. Please contact the corresponding marketing organization and ask for the ordering information of the control variant optimized for your application.

15.1 Type code

Type short description	1	2	3	4	5	6	7	8	9	0	1	2	3	4	5	6	7	8	9	0	1	2	3	4	5	6	7	8	9	0	1	2	3	4								
Example:	X	M	2	1	0	.	0	1	-	0	1	-	3	1	-	3	N	-	0	0	1	-	N	N	-	1	0	1	N	3	0	N										
01 Device type IO-Box, modular, performance class = XM2																																										
02 CPU-Variant Atom E620T = 1 Atom E660T = 2																																										
03 Variant (00-99) BR-Standard = 00 Extended certifications = 01 ³⁾ Linux = 02 ²⁾ OEM Standard = 10																																										
04 Design FPGA Standard = 01 FPGA Standard OEM = 02																																										
05 Field bus on-board sercos master (MultiEthernet) = 01 PROFINET RT Controller = 04																																										
06 Interface (ETH, USB) USB Device & Host + ETH 1 GBit = 31 ¹⁾																																										
07 Remanent memory Min. 128 kB = 3																																										
08 Mass storage (HDD, Flash) SD min. 1 GB = 1 SD min. 8 GB = 2 ²⁾																																										
09 Hardware extension (XFE...) 0 x module over XA-BS01 = 001 3 x module over XA-BS02 = 301																																										
10 Housing design Bosch Rexroth Standard design = NN OEM design = 01																																										
11 System characteristic Without = N IndraMotion MLC = 1 IndraMotion MTX = 2 Linux = 3																																										

Fig. 15-1: Type code, part 1

Type short description	1	2	3	4	5	6	7	8	9	0	1	2	3	4	5	6	7	8	9	0	1	2	3	4	5	6	7	8	9	0	1	2	3	4	
Example:	X	M	2	2	1	0	.	0	1	-	0	1	-	3	1	-	3	N	-	0	0	1	-	N	N	-	1	0	1	0	1	N	3	0	N
12 Basis system (Function package)																																			
Without.....	= NN																																		
PLC.....	= 00																																		
PLC + MOT.....	= 01																																		
PLC + MOT + TEC.....	= 02																																		
PLC + MOT + ROCO.....	= 03																																		
PLC + MOT + TEC + ROCO.....	= 04																																		
PLC + MOT + HYD.....	= 05																																		
PLC + MOT + TEC + HYD.....	= 06																																		
PLC + MOT + ROCO + HYD.....	= 07																																		
PLC + MOT + TEC + ROCO + HYD.....	= 08																																		
13 Option 1 (Field bus protocols for MultiEthernet)																																			
Without.....	= N																																		
EtherCAT Softstack – Master.....	= 1																																		
EtherCAT Softstack – Slave.....	= 2																																		
14 Option 2 (Function package “Communication”)																																			
Without.....	= N																																		
OPC UA.....	= 1																																		
OCI.....	= 2																																		
OPC UA + OCI.....	= 3																																		
15 Option 3 (Reserve)																																			
Without.....	= N																																		
16 Option 4 (Reserve)																																			
Without.....	= N																																		

Note:

- 1) = 1 x USB Host + 1 x USB Device + 1 x Ethernet 1 Gbit
 - 2) HW-Variant “2” only in combination with 08 Mass Storage “2” and 11 System characteristic “3”.
 - 3) Marine & Offshore; IECEx & ATEX
- By the attribute values **01** , **06**, **07** - **09** and **15** - **16** there are no dependencies

Fig. 15-2: Type code, part 2

15.2 Accessories and spare parts

For ordering information on accessories and spare parts, refer to [chapter 5 "Spare parts, accessories and wear parts"](#) on page 5.

16 Disposal

16.1 General Information

Dispose the products according to the respective national standard.

16.2 Return

For disposal, our products can be returned free of charge. However, the products must be free of remains like oil and grease or other impurities.

Furthermore, the products returned for disposal must not contain any undue foreign substances or components.

Send the products free of charge to the following address:

Bosch Rexroth AG
Electric Drives and Controls
Bürgermeister-Dr.-Nebel-Straße 2
D-97816 Lohr am Main, Germany

16.3 Packaging

The packaging material consists of cardboard, plastics, wood or styrofoam. Packaging material can be recycled anywhere.

For ecological reasons, please do not return empty packages to Bosch Rexroth.

17 Service and support

Our worldwide service network provides an optimized and efficient support. Our experts offer you advice and assistance should you have any queries. You can contact us **24/7**.

Service Germany

Our technology-oriented Competence Center in Lohr, Germany, is responsible for all your service-related queries for electric drive and controls.

Contact the **Service Hotline** and **Service Helpdesk** under:

Phone: **+49 9352 40 5060**
Fax: **+49 9352 18 4941**
E-mail: service.svc@boschrexroth.de
Internet: <http://www.boschrexroth.com/>

Additional information on service, repair (e.g. delivery addresses) and training can be found on our internet sites.

Service worldwide

Outside Germany, please contact your local service office first. For hotline numbers, refer to the sales office addresses on the internet.

Preparing information

To be able to help you more quickly and efficiently, please have the following information ready:

- Detailed description of malfunction and circumstances
- Type plate specifications of the affected products, in particular type codes and serial numbers
- Your contact data (phone and fax number as well as your e-mail address)

Index

A

Accessories.....	5
Air humidity.....	7
Ambient conditions.....	6
Ambient temperature.....	6
ANSI Z535.6-2006.....	3
Atex.....	11

B

Broadband noise.....	7
Bus base module.....	6

C

Call initial firmware again.....	41
CE marking.....	10
Commission.....	29
Complaints.....	2
Connections at front side.....	14
Control	
Demount.....	22
Control bus base module.....	15
Control, mounting.....	19
Criticism.....	2
Current consumption.....	9
Customer Feedback.....	2

D

Declaration of conformity.....	10
Demount.....	22
Demounting.....	16
Device description.....	33
Dimensions.....	18
Disposal.....	57
Distances.....	17
Distances for cooling.....	17
Documents, related.....	2

E

Electric Installation.....	24
Electrical isolation.....	26, 27
Emitted interference.....	8
End clamp.....	6, 16
Error causes.....	53
Explosion protection.....	11
Extension bus.....	15
Extension modules	

Mounting.....	21
External power supply unit.....	24

F

Fallback and recovery.....	42
Feedback.....	2
File manager.....	50
Firmware management.....	45
Functional earth.....	29

G

Grounding	
.....	28

H

Hardware data.....	44
Hazard warning.....	3
Helpdesk.....	57
Hotline.....	57
Housing dimensions.....	18

I

IECEX.....	11
IndraControl First Touch.....	43
Initial firmware.....	38
Installation.....	16
Installation, electric.....	24
Intended use.....	5
Interfaces.....	14

L

LED block of 10.....	35
LEDs and operating elements.....	34
LEDs in XD1 plug.....	34

M

Maintenance schedule.....	54
Memory card.....	6
Minimum distances.....	17
Mounting.....	16
Mounting control.....	19
Mounting extension modules.....	21
Mounting location.....	16
Mounting rail.....	16
Mounting S20 I/O modules.....	20

N	
Network settings.....	44
O	
Operating altitude.....	7
Operation mode switches.....	36
Ordering information.....	54
P	
Potential equalization.....	29
Power connector XD1.....	26
Power connectors, 24 V.....	5
Power supply unit, external.....	24
Processor.....	8
Product identification.....	2
Protective conductor.....	27
R	
Reference conductor.....	27
Related documents.....	2
Reset button.....	37
RNDIS device driver.....	30
S	
S20 I/O modules, mounting.....	20
S20 interface.....	15
Safety alert symbol.....	3
Safety instructions.....	3
Scope of delivery.....	3
SD Card.....	6
Service hotline.....	57
Shielding.....	29
Shock resistance.....	7
Shock test.....	7
Signal words.....	3
Spare parts.....	5
Standards.....	10
Suggestions.....	2
Support.....	57
Symbols used.....	4
T	
Target groups.....	1
Technical data.....	8
Troubleshooting.....	53
Type code.....	55
Type plate.....	2
U	
UL/CSA certified.....	10
UPS.....	26
USB device interface.....	30
Use, intended.....	5
V	
Voltage supply.....	9, 25, 26
Voltage supply, dimensioning.....	28
W	
Warnings.....	3
Wear parts.....	5, 6
X	
XD1.....	26
XF31.....	30, 53

Notes

Bosch Rexroth AG

Electric Drives and Controls

P.O. Box 13 57

97803 Lohr, Germany

Bgm.-Dr.-Nebel-Str. 2

97816 Lohr, Germany

Phone +49 9352 18 0

Fax +49 9352 18 8400

www.boschrexroth.com/electrics



R911340667