



CPI™/A-LOK® Tube Fittings

Catalog 4230/4233

December 2012

aerospace
climate control
electromechanical
filtration
fluid & gas handling
hydraulics
pneumatics
process control
sealing & shielding



ENGINEERING YOUR SUCCESS.



Huntsville, Alabama, USA



Barnstaple, UK

⚠ WARNING – USER RESPONSIBILITY

FAILURE OR IMPROPER SELECTION OR IMPROPER USE OF THE PRODUCTS DESCRIBED HEREIN OR RELATED ITEMS CAN CAUSE DEATH, PERSONAL INJURY AND PROPERTY DAMAGE.

This document and other information from Parker-Hannifin Corporation, its subsidiaries and authorized distributors provide product or system options for further investigation by users having technical expertise.

The user, through its own analysis and testing, is solely responsible for making the final selection of the system and components and assuring that all performance, endurance, maintenance, safety and warning requirements of the application are met. The user must analyze all aspects of the application, follow applicable industry standards, and follow the information concerning the product in the current product catalog and in any other materials provided from Parker or its subsidiaries or authorized distributors.

To the extent that Parker or its subsidiaries or authorized distributors provide component or system options based upon data or specifications provided by the user, the user is responsible for determining that such data and specifications are suitable and sufficient for all applications and reasonably foreseeable uses of the components or systems.

Offer of Sale

The items described in this document are hereby offered for sale by Parker-Hannifin Corporation, its subsidiaries or its authorized distributors. This offer and its acceptance are governed by the provisions stated in the detailed "Offer of Sale" elsewhere in this document or available at www.parker.com/ipdus.

© Copyright 2004, 2005, 2008, 2012 Parker Hannifin Corporation. All Rights Reserved.



Parker Hannifin Corporation
Instrumentation Products Division
Huntsville, AL USA
<http://www.parker.com/ipdus>

Table of Contents

Introduction	2
Parker Suparcase®	3
Visual Index	6
Typical Raw Material Specifications	9
Tube End Dimensional Data	9
Nomenclature (How to Order)	10
CPI™/A-LOK® Options	11
Tube to Male Pipe Fittings	12
Tube to Female Pipe Fittings	24
Tube to Tube Unions	30
Port Connectors	38
37° Flare (AN) to CPI™/A-LOK® Fittings	51
Tube to O-Ring Seal Fittings	52
Tube to Welded Systems	61
Analytical Fittings	65
Barbed Fittings	70
Components	71
Assembly & Remake Instructions	78
Gaugeability Instructions	78
Instrument Tubing Selection Guide	79
Thread & Tube End Size Chart (USA)	83
Offer of Sale	88
Parker Motion & Control Technologies	inside back cover

Introduction

Parker CPI™/A-LOK® Instrumentation Tube Fittings are designed as leak-free connections for process, power and instrumentation applications. These single and two ferrule fittings are manufactured to the highest quality standards and are available in a broad range of sizes, materials and configurations.

Features

The Parker CPI™/A-LOK® tube fitting has been specifically designed for use on instrumentation, process and control systems, analysers and environmental equipment employed in chemical, petroleum, power generating and pulp and paper plants. CPI™/A-LOK® fittings have also been used extensively in other applications and industries wherever high reliability and quality are required.

Materials

Parker CPI™/A-LOK® fittings are available as standard in Heat Code Traceable, 316 stainless steel. Other materials include steel, brass, aluminum, nickel-copper, Hastelloy C®, Alloy 600, Titanium, 6Mo, Incoloy 625 and 825. The raw materials used fully conform to the chemical requirements listed in the [Typical Raw Material Specifications table found on page 9](#). For nuclear and other critical applications, stainless steel CPI™/A-LOK® fittings are readily available with documented heat code traceability.

Pipe Fittings/Adapters

Parker CPI™/A-LOK® tube fittings are available in combination with a variety of ISO and ANSI pipe thread configurations. For a full listing of these fittings, see Catalog 4260.

Tubing

Parker CPI™/A-LOK® tube fittings can be used with a wide variety of tubing materials and a broad range of tube wall thicknesses. CPI™/A-LOK® seals equally well on both thin wall and heavy wall tubing. **Tubing and fitting materials should be selected to be compatible with the fluid media. Due to thermal expansion characteristics and chemical stability, the tubing should be of the same material as the fitting. (The exception is brass fittings and copper tubing.)**

Torque

Parker CPI™/A-LOK® tube fittings do not twist the tubing during installation. CPI™/A-LOK® ferrule designs assure that all make and remake motion is transmitted axially to the tubing. Since no radial movement of the tubing occurs, the tubing is not stressed. The mechanical integrity of the tubing is maintained.

No Distortion

In make-up, there is no undue force in an outward direction to distort the fitting body or ferrules to cause interference between the ferrules and nut. This assures that the nut will back-off freely for disassembly and permits a greater number of easy remakes.

Sealing

Positive, reliable connections with Parker CPI™/A-LOK® fittings have been qualified by exhaustive tests and over four decades of experience in the manufacture of quality tube fittings.

Nomenclature

Parker CPI™/A-LOK® fitting part numbers are constructed from symbols that identify the size and style of the fitting and material used.

Assembly, Remake, Gaugeability

Proper assembly is the key component to a leak-free system. CPI™/A-LOK® tube fitting assembly, remake and gaugeability instructions are [found on page 78](#) of this catalog.

Pressure Rating & Tubing Selection

For working pressures of CPI™/A-LOK® tube connections, please see pages 80–81 of this catalog, the Instrument Tubing Selection Guide (4200-TS) found in the Technical Section of your Parker Instrumentation Products Process Binder, or the Parker Instrument Tube Fitting Installation Manual (Bulletin 4200-B4).

In cases where a male or female pipe thread is the second end of a Parker CPI™/A-LOK® fitting, such threads may be the pressure limiting factor of the tubing system. Pressure ratings for Pipe Ends are shown on page 82.

Parker Supercase® Ferrules

The ferrule is a critical, highly engineered component of tube fittings. It requires considerable expertise and care in design, metallurgy and production processes. In order to ensure a high integrity, leak-free connection the leading edge of the ferrule must be hardened for sealing and gripping on stainless steel tubing. Parker has been using a unique, proprietary process, Parker Supercase®, to harden its stainless steel ferrules for over 25 years. The Parker Supercase® process generates the hardness required without reducing the corrosion resistance of stainless steel, in fact greatly enhancing it in many demanding applications.

The Parker CPI™ ferrule and the Parker A-LOK® back ferrule in type 316 stainless steel and the 6Mo superaustenitic stainless steel are hardened by the Supercase® process in sizes 1/4" and larger for optimum performance.

Parker Supercase® Technology

Prior ferrule designs used traditional high temperature gas carburizing and/or nitriding to harden the ferrule. These processes formed stable chromium nitrides and carbides, making the chromium no longer available to resist corrosion in the hardened region. The high temperature employed also caused sensitization under the hardened layer leaving this region also susceptible to corrosion.

The Parker Supercase®, hardening process retains the chromium in solid solution as an alloying element available for corrosion resistance. Also, the bulk metal is unaffected by the process; there is no sensitization and the mechanical strength properties of the metal beneath the hardened layer are not changed. The Supercase® hardened layer is continuous, free of defects and voids, is ductile, able to deform with the ferrule during fitting assembly without cracking or spalling.

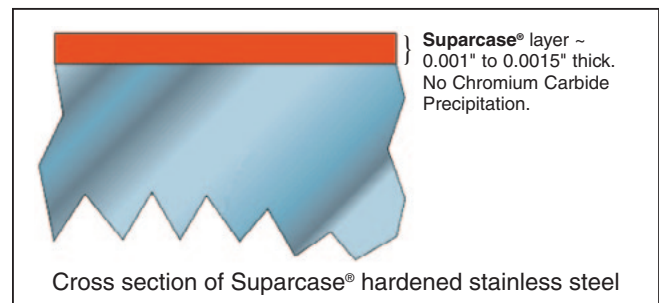

The Parker Supercase® ferrule has a surface hardness of approximately 70 on the Rockwell C scale, considerably higher than untreated stainless steel, ensuring that Parker Instrumentation fittings will seal under internal pressure without leakage or blow-out of the tube until the tubing fractures. They can be disassembled and reassembled numerous times with no loss of sealing integrity.

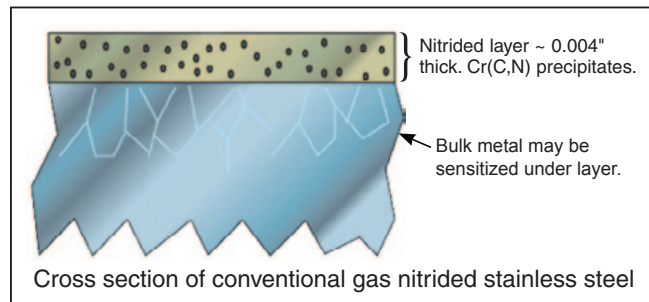

Corrosion Resistance of Parker Suparcase®

Samples of Suparcase® treated and untreated type 316 stainless steel were immersed in the following corrosive solutions for 554 hours at 25°C and their weight loss measured:

- 50% sulfuric acid
- 50% nitric acid
- 30% acetic acid
- 5% sodium hypochlorite
- TAPPI simulated black liquor

All Suparcase® treated test samples had no weight loss or less loss than the untreated type 316 stainless steel samples.

Salt fog corrosion tests were performed on tubular test pieces machined from the same cold worked type 316 stainless steel solid barstock used by Parker for the 3/8" CPI™ ferrules. The Salt Fog test is designed to simulate exposure to a humid marine environment. The test pieces were the same length, OD and ID as the 3/8 inch CPI™ ferrule. The testing was performed per ASTM B117, "Standard Practice for Operating Salt Spray (Fog) Apparatus", on as-machined samples, as-machined plus Suparcase® treated samples, and annealed plus Suparcase® treated samples, with six samples per condition. No corrosion was observed on any of the samples after 96 hours of exposure.

Pitting corrosion resistance testing was done per ASTM G48, "Standard Test Methods for Pitting and Crevice Corrosion Resistance of Stainless Steels and Related Alloys by Use of Ferric Chloride Solution" using test samples prepared similar to the salt fog test procedures. This is an accelerated corrosion test used to rank the relative resistance of stainless steels and related alloys to pitting and crevice corrosion when exposed to oxidizing chloride environments. The as-machined samples were aggressively pitted, whereas there was no observable pitting or measurable weight loss on either condition of the Parker Suparcase® treated samples after 72 hours of exposure.



In addition, ASTM G150 CPT (critical pitting temperature) testing has verified that the corrosion resistance of Supercase® 316 stainless steel is well above the 20°C of standard 316 stainless steel.

Stress corrosion cracking (SCC) tests were performed in chloride, sulfide and caustic media. These tests utilized 0.125" diameter miniature round tensile test pieces in the as-machined plus Supercase® treated condition. The chloride SCC test was performed per ASTM G36, "Standard Practice for Evaluating Stress-Corrosion-Cracking Resistance of Metals and Alloys in a Boiling Magnesium Chloride Solution." The results demonstrate that the Parker Supercase® process markedly improves the resistance of type 316 stainless steel to chloride SCC, as shown in the graph at right.

Sulfide SCC testing was performed per the NACE TM0177 test method and the caustic SCC test was performed in 35% NaOH boiling at 125°C. No differences were found between the untreated and the Parker Supercase® samples in these tests.

Parker Supercase® ferrules have a history of over 25 years of leak-free, high integrity tubing connections in a wide variety of demanding applications throughout the world.

Critical Pitting Temperature Test

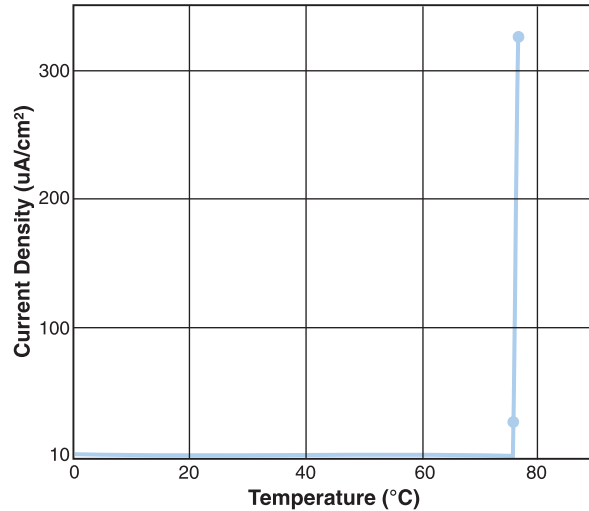

Materials Technology Associates Inc.

Stress Corrosion Test Results

42% MgCl₂ Boiling 152°C

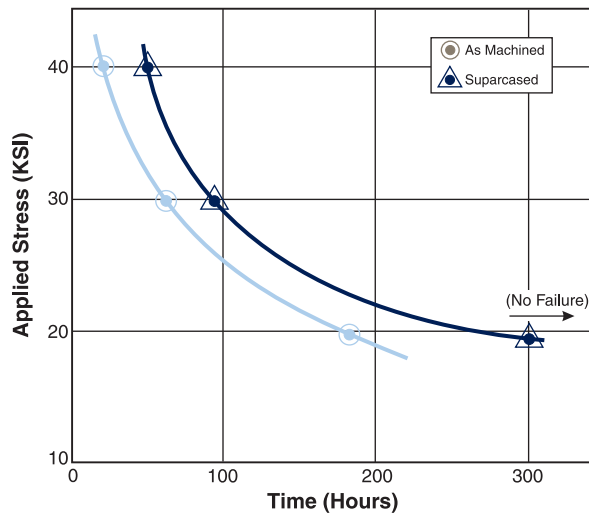

Visual Index

Tube to Male Pipe

Male Connector
 FBZ, MSC
[pages 12-16](#) 

Male Bulkhead Connector
 FH2BZ, MBC
[page 17](#) 

Thermocouple Connector
 FH4BZ, MTC
[page 18](#) 

Male Elbow
 CBZ, MSEL
[pages 18-20](#) 

NPT Male 45° Elbow
 VBZ, MVEL
[page 21](#) 

NPT Male Run Tee
 RBZ, MRT
[page 22](#) 

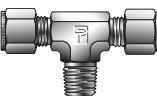
NPT Male Branch Tee
 SBZ, MBT
[page 23](#) 

Tube to Female Pipe

Female Connector
 GBZ, FSC
[pages 24-25](#) 

Female Bulkhead Connector
 GH2BZ, FBC
[page 26](#) 

Gauge Connector
 GBZ, FSC
[pages 26-27](#) 

Female Elbow
 DBZ, FEL
[page 27](#) 

Female Run Tee
 MBZ, FRT
[page 28](#) 

Female Branch Tee
 OBZ, FBT
[page 29](#) 

Tube to Tube Unions

Union
 HBZ, SC
[page 30](#) 

Conversion Union
 HBZ, CU
[page 31](#) 

Reducing Union
 HBZ, RU
[page 31](#) 

Bulkhead Union
 WBZ, BC
[page 32](#) 

Dielectric Union Adapter, Dielectric Assembly
 DEBTA, DELTA
[page 33](#) 

Union Elbow
 EBZ, EE, ELZ
[pages 33-34](#) 

Union Tee
 JBZ, ET
[page 35](#) 

Drop Size Tee
 JBZ, JLZ
[page 36](#) 

Union Cross
 KBZ, ECR
[page 37](#) 

Port Connectors

Tube End Reducer
 TRBZ, TUR, TUC
[pages 38-40](#) 

Tube End Bulkhead Adapter
 T2H2BZ, TUBC
[page 41](#) 

Port Connector
 ZPC, PC
[page 41](#) 

Tube End Male Adapter
 T2HF, MA
[pages 42-45](#) 

Tube End to SAE Straight Thread Adapter
 T2HOA, TUOHA
[page 46](#) 

Tube End Female Adapter
 T2HG, FA
[pages 46-48](#) 

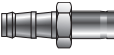
Push-Lok to Tube Adapter
 P2T2, P2TU
[page 48](#) 

Push-Lok to Male Adapter
 P2HF
[page 49](#) 

Push-Lok to CPI™/A-LOK®
 P2BZ6, P2LZ6
[page 49](#) 

Push-Lok to Port Connector
 ZPB2, ZPC2
[page 49](#) 

Lapped Joint Tube Adapters
 LJFBZ, LJF
[page 50](#) 

DP Transmitter Calibration Adapters
 ZH2LX
[page 50](#) 

37° Flare (AN) to CPI™/A-LOK®

37° Flare (AN) to CPI™/A-LOK®
 X6HBZ6, X6TU
[page 51](#) 

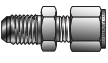
37° Flare Connector to CPI™/A-LOK®
 XHBZ, XASC
[page 51](#) 

37° Flare Bulkhead Connector to CPI™/A-LOK®
 XH2BZ, XABC
[page 51](#) 

Tube to O-Ring Seal

Male Connector SAE Straight Thread
 ZHBA, M1SC
[page 53](#) 

Male SAE Straight Thread Elbow
 C5BZ, M5SEL
[page 54](#) 

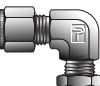
Male BSPP Straight Thread Elbow
 CBZ, MSEL
[page 54](#) 

Male Run Tee SAE Straight Thread
 R5BZ, M5RT
[page 55](#) 

Male BSPP Run Tee Straight Thread
 RBZ, MRT
[page 55](#) 

Visual Index

Male Branch Tee SAE Straight Thread

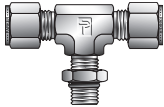
S5BZ, M5BT
[page 56](#) 

Male BSPP Branch Tee Straight Thread

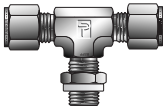
SBZ, MBT
[page 56](#) 

Long Male Connector SAE Straight Thread

ZH3BA, ZH3LA
[page 57](#) 

45° Positionable Male Elbow

V5BZ, M5VEL
[page 57](#) 

Male Connector to O-Ring Straight Thread

ZHBA5, M2SC
[page 58](#) 

Male Connector to O-Ring Pipe Thread

ZHBF5, M3SC
[page 58](#) 

Tube End to O-Ring Straight Thread

T2HOA5, M2TU
[page 59](#) 

Tube End to O-Ring Pipe Thread

T2HOF5, M3TU
[page 59](#) 

Pipe Thread to SAE Straight Thread Adapter

FHOA
[page 60](#) 

Bulkhead to Conversion Adapter

AH2BZ, AH2LZ
[page 60](#) 

Tube to Welded Systems

Socket Weld Elbow

ZEBW, ZELW
[page 62](#) 

Buttweld Elbow

ZEBW2, ZELW2
[page 62](#) 

Socket Weld Connector

ZHBW, ZHLW
[page 63](#) 

Buttweld Connector

ZHBW2, ZHLW2
[pages 63-64](#) 

Analytical Fittings

Column End Fitting — Low Internal Volume with Frit

Z2HCZ7, Z2HLZ7
[page 66](#) 

Column End Fitting — Low Internal Volume

Z3HCZ7, Z3HLZ7
[page 66](#) 

Column End Fitting — Low Internal Volume (without Frit)

ZHCZ7, ZHLZ7
[page 67](#) 

Column End Fitting — with Frit

Z2HCZ, Z2HLZ
[page 67](#) 

Column End Fitting (without Frit)

ZHCZ, ZHLZ
[page 68](#) 

Union Connector — Low Dead Volume

Z7HBZ7, Z7HLZ7
[page 68](#) 

Male Connector — Low Dead Volume

FBZ7, FLZ7
[page 69](#) 

Sanitary Flange Fitting

ZHBS, ZHLS
[page 69](#) 

Barbed Fittings

Barbed Connector to Male Pipe

B2HF
[page 70](#) 

Barbed Connector to Tube Adapter

B2HT2, B2TU
[page 70](#) 

Hose Connector Sleeve

HCS
[page 70](#) 

Components

Insert

TIZ
[page 71](#) 

Tube Nut

BZ, NU
[pages 71-72](#) 

Inverted Tube Nut

BZI
[page 72](#) 

Knurled Nut

BZP
[page 72](#) 

Ferrules

TZ
[page 72](#) 

Front Ferrules

FF
[page 73](#) 

Back Ferrules

BF
[page 73](#) 

Ferrule Holder

[page 73](#) 

Plug

FNZ, BLP
[page 74](#) 

Cap

PNBZ, BLEN
[pages 74-75](#) 

Vent Protector

MDF
[page 75](#) 

Sealing Washers Bonded Seal and Copper

[page 76](#) 

Bulkhead Locknut

WLZ, WLN, BN
[page 77](#) 

Accessory Locknut

L5NR
[page 77](#) 

Reference Material

[Assembly and Remake Instructions](#)
[page 78](#)

[Gaugeability Instructions](#)
[page 78](#)

[Instrument Tubing Selection Guide](#)
[pages 79 – 82](#)

[Pipe End Pressure Ratings](#)
[page 82](#)

[Thread and Tube End Size Charts \(USA/ International\)](#)
[pages 83-85](#)

[Offer of Sale](#)
[page 88](#)

Parker CPI™/A-LOK® fittings consists of precision engineered parts designed to provide secure leak-proof joints capable of satisfying high pressure, vacuum and vibration applications.

Inch — CPI™

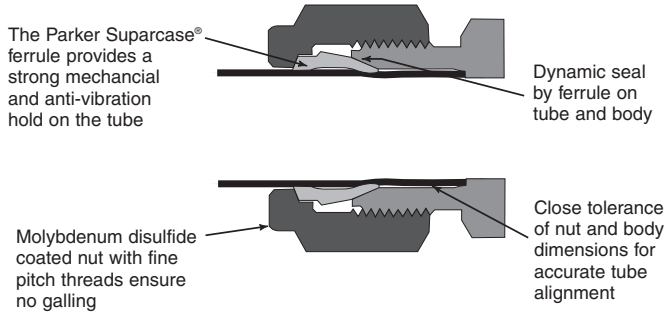

Inch — A-LOK®

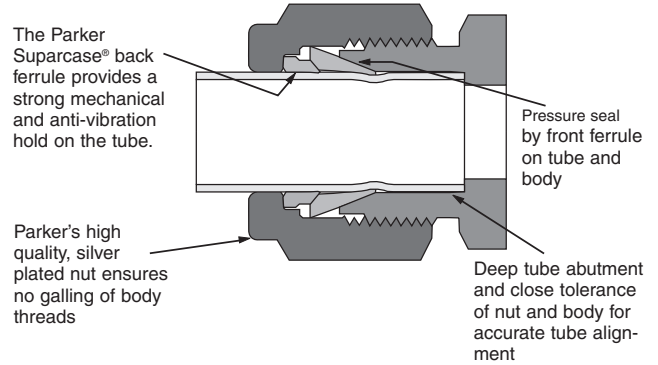

Metric — CPI™

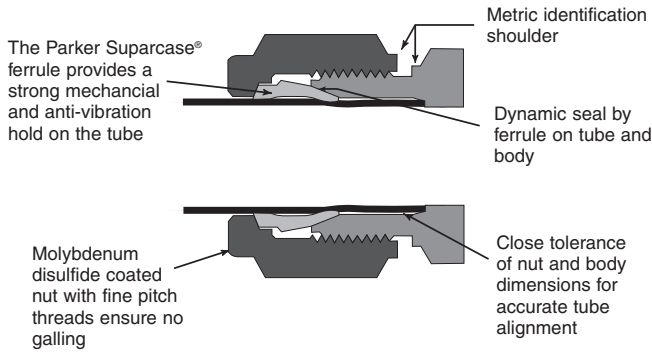

Metric — A-LOK®

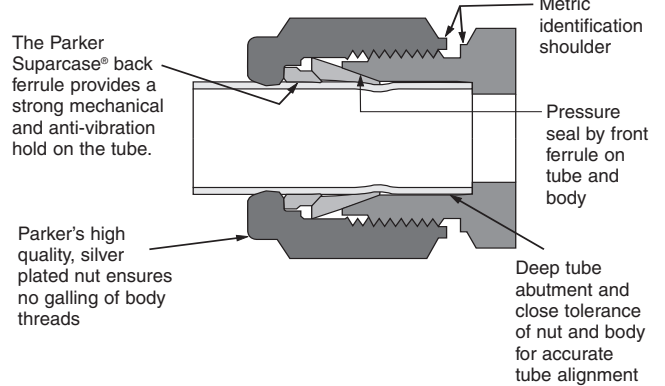

Parker Instrumentation Tube Fittings are supplied complete and ready to use. The ferrule(s) swage onto the tube as it moves down the body seat creating a pressure/vacuum-tight seal on both tube and body by the interface pressure and surface finish of mating components. The Parker Supercase® ferrule (back-ferrule only on A-LOK®) creates a strong mechanical hold on the tube.

Typical Raw Material Specifications

BASIC FITTING MATERIAL	MATERIAL DESIGNATOR	STRAIGHTS	SHAPES	COMMON TUBING SPECIFICATION
Brass	B	CA-360 QQ-B 626 Alloy 360 ASTM-B16 Alloy 360 CA-345 ASTM-B-453 Alloy 345	CA-377 QQ-B 626 Alloy 377 ASTM-B-124 Alloy 377 BS2872 CZ122	ASTM-B75 ASME-SB75 (TEMPER "O")
Stainless Steel (Type 316) ⁽¹⁾	A-LOK® = 316 ⁽¹⁾⁽²⁾ CPI™ = SS	ASME-SA-479 Type 316-SS BS970 316-S31 DIN 4401 ASTM A276 Type 316 ASTM/ASME-SA-182	ASME-SA-182 316 BS970 316-S31 DIN 4401	ASME-SA-213 ASTM-A-213 ASTM-A-249 ASTM-A-269 ⁽³⁾ MIL T-8504 MIL T-8506
Steel	S	ASTM-A-108 QQ-S-637	ASTM-A-576	SAE J524b SAE J525b ASTM-A-179
Aluminum	A	2017-T4 or 2024-T4 ASTM-B211 QQ-A-225/5 or 6	2014T (as fabricated) ASTM-B-211 QQ-A-225/4	303, 6061T6 ASTM-B-210
Monel® 400 – Forgings Monel® 405 – Bar Stock	M	ASTM-B-164 QQ-N-281 BS3076 NA13	ASTM-B-164 QQ-N-281 BS3076 NA13	ASTM-B-165
Hastelloy® C-276	HC	ASTM-B-574 ASTMB575	ASTM-B-574	ASTM-B-622 ASTM-B-626
Inconel® Alloy 600	IN	ASTM B-166 ASME-SB-166	ASTM-B-564	ASTM-B-163
Carpenter® 20	SS20	ASTM-B-473	ASTM-B-462 ASTM-B-472	ASTM-B-468
Titanium	T	ASTM-B-348	ASTM-B-381	ASTM-B-338
Inconel® Alloy 625	625	BS3076 NA16 ASTMB425	BS3076 NA16 ASTMB425	ASTM-B-625 ASTM-B-444 ASTM-B-423 ASTM-B-829
Incoloy® Alloy 825	825			
6MO	6MO	UNS S31254 UNS N08367 ASTM A479	UNS S31254 UNS N08367 ASTM A 479	ASTM-A-269

- (1) If more specific information, including heat code traceability, is required, your Parker Hannifin CPI™/A-LOK® distributor will provide details.
 (2) If an "L" appears in the A-LOK® fitting description, then the material designator will be "SS" (e.g., JLZ drop size tee).
 (3) Stainless steel CPI™/A-LOK® tube fittings work reliably on both seamless and welded-redrawn, fully annealed type 304, 316 and 316L tubing.
NOTE: Hastelloy® is a registered trademark of Haynes International. Inconel®, Incoloy® and Monel® are registered trademarks of Special Metals Corporation.
 Carpenter® is a registered trademark of CRS Holdings Inc.

Tube End Dimensional Data

SIZE NO.	INCHES					
	TUBE O.D.	STRAIGHT THREAD	†C	H HEX	E DIA.	†D TUBE INS. DEPTH
1	1/16	10-32	.43	5/16	.052	.34
2	1/8	5/16-20	.60	7/16	.093	.50
3	3/16	3/8-20	.64	1/2	.125	.54
4	1/4	7/16-20	.70	9/16	.187	.60
5	5/16	1/2-20	.73	5/8	.250	.64
6	3/8	9/16-20	.76	11/16	.281	.67
8	1/2	3/4-20	.87	7/8	.406	.90
10	5/8	7/8-20	.87	1	.500	.96
12	3/4	1-20	.87	1-1/8	.625	.96
14	7/8	1-1/8-20	.87	1-1/4	.750	1.03
16	1	1-5/16-20	1.05	1-1/2	.875	1.24
20	1-1/4	1-5/8-20	1.52	1-7/8	1.09	1.61
24	1-1/2	1-15/16-20	1.77	2-1/4	1.34	1.96
32	2	2-5/8-20	2.47	2-3/4	1.81	2.65

NOTE: Dimensions C and D are shown in the finger-tight position.

† Average Value

Dimensions for reference only, subject to change.

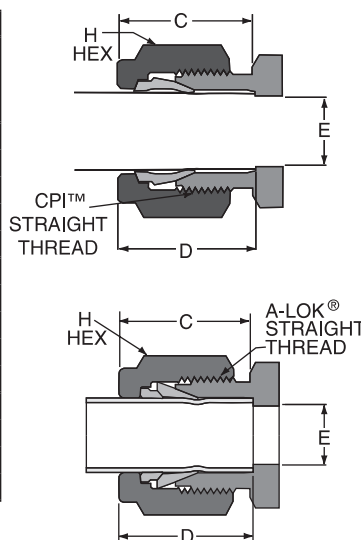

SIZE NO.	MILLIMETERS					
	TUBE O.D.	STRAIGHT THREAD	†C	H HEX	E DIA.	†D TUBE INS. DEPTH
2	2mm	5/16-20	15,3	12,0	1,7	12,9
3	3mm	5/16-20	15,3	12,0	2,4	12,9
4	4mm	3/8-20	16,1	12,0	2,4	13,7
6	6mm	7/16-20	17,7	14,0	4,8	15,3
8	8mm	1/2-20	18,6	15,0	6,4	16,2
10	10mm	5/8-20	19,5	18,0	7,9	17,2
12	12mm	3/4-20	22,0	22,0	9,5	22,8
14	14mm	7/8-20	22,0	24,0	11,1	24,4
15	15mm	7/8-20	22,0	24,0	11,9	24,4
16	16mm	7/8-20	22,0	24,0	12,7	24,4
18	18mm	1-20	22,0	27,0	15,1	24,4
20	20mm	1-1/8-20	22,0	30,0	15,9	26,0
22	22mm	1-1/8-20	22,0	30,0	18,3	26,0
25	25mm	1-5/16-20	26,5	35,0	21,8	31,3

NOTE: Dimensions C and D are shown in the finger-tight position.

† Average Value

Dimensions for reference only, subject to change.

Nomenclature/How to Order

Parker CPI™/A-LOK® tube fitting part numbers are constructed using alphanumeric characters to identify the size, style and material of the fitting.

CPI™ Inch Parts



Example: 8 – 4 – FBZ – SS
 1/2" Tube O.D. – 1/4" Pipe Thread (blank – see Note 1 below) Male Connector – Stainless Steel – (blank)

Part Number as it is ordered (without options): 8-4 FBZ-SS. This part appears on page 12 and is a CPI™ NPT male connector.

A-LOK® Inch Parts



Example: 8 – MSC – 4 – N – 316
 1/2" Tube O.D. Male Connector 1/4" Pipe Thread NPT – Stainless Steel – (blank)

Part Number as it is ordered (without options): 8MSC4N-316. This part appears on page 12 and is an A-LOK® NPT male connector.

CPI™ Metric Parts



Example: GBZ – 12 – 1/4 – K – SS
 Female Connector 12mm – 1/4" BSP – Stainless Steel – (blank)

Part Number as it is ordered (without options): GBZ 12-1/4K-SS. This part appears on page 25 and is a CPI™ BSP female connector.

A-LOK® Metric Parts



Example: M12 – FSC – 1/4 – N – 316
 12mm Female Connector 1/4" NPT – Stainless Steel – (blank)

Part Number as it is ordered (without options): M12FSC1/4N-316. This part appears on page 24 and is a A-LOK® NPT female connector.

Body Designator: A letter or combination of letters and numbers are used to designate the type of fitting. See the visual index on pages 6-7 for body designator.

Fractional Size: Tube and pipe thread sizes are designed by the number of sixteenths of an inch (1/2" tube = 8/16" = 8) (1/4" pipe thread = 4/16" = 4).

Metric Size: Metric tube is designated in millimeters and prefixed "M" (i.e., 12mm tube – M12.) The pipe thread size is written as a fraction (i.e., 1/4 NPT = 1/4).

All Straights & Elbows: Call out largest CPI™/A-LOK® tube end size first followed by the smaller CPI™/A-LOK® tube end or pipe thread size.

Fractional Tees & Crosses: For drop size tees – first size the run (1 to 2) and then branch (3). Example – the size designator for a male run tee for 3/8" O.D. tube and 1/4" male pipe thread would be 6-4-6. For crosses – first size the run (1 to 2) and then the branch (3 to 4). For tees with all ends the same, use the tube and size before and after the style designator; i.e. 4-4-4 JBZ (CPI™), 4ET4 (A-LOK®).

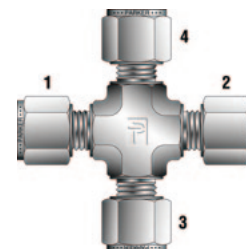

Metric Tees & Crosses: For drop size tees – first size the run (1 to 2) and then branch (3). Example – the size designator for a male run tee for 6mm tube and 1/4" male pipe thread would be 6-4-6. For crosses – first size the run (1 to 2) and then the branch (3 to 4). For tees with all ends the same, use the tube end size after the style designator; i.e. JBZ 4-4-4 JBZ (CPI™), ETM4 (A-LOK®).

Material: See Table 1 on the previous page for the material symbol.

Thread Types:

N = NPT ⁽¹⁾ /National Pipe Taper	ANSI B1.20.1
K = BSP/ISO Taper	BS21, ISO7/1
R = BSP/ISO Parallel	BS2779, ISO 228/1+2, DIN 3852 FORM A ⁽²⁾
BR = BSP/ISO Parallel	BS2779, ISO 228/1+2, DIN 3852 FORM B ⁽³⁾
M = Metric Thread	ISO 6149-2
R-ED = BSPP/ISO Parallel	BS2779, ISO 228/1+2, DIN 3852 with elastic sealing washer ⁽⁴⁾
GC = BSPP Gauge Connector	B2779, ISO 228/1+2, DIN 3852

- (1) N thread designator is only used for A-LOK® nomenclature.
- (2) Form A requires the use of a bonded washer. See page 76 of this catalog.
- (3) Form B (cutting face) may be used with or without a sealing washer.
- (4) ED fittings are supplied with Nitrile sealing washers as standard. Fluorocarbon seals are available upon request.

Special Fittings: Consult the factory. If there is any question as to the fitting desired, particularly for special fitting configurations, it is suggested that a customer print be submitted.

Special Options: See the following page for available options.

Color Coding

For easy reference, table column headings are color indicated as follows:

fractional

metric

CPI™/A-LOK® Options

Parker CPI™/A-LOK® fittings may be ordered with the following options.

How to order

After the complete CPI™/A-LOK® number simply add a "dash" then the suffix for the option.

The following example is an A-LOK® male connector for 1/2" OD tube and 1/4" male pipe that has been cleaned for oxygen service. For additional options, please consult the factory.

8MSC4N-316-C3

Suffix	Option	Additional Information
ZYF	Assembled with nylon ferrule(s)	
ZY	Ferrule only (e.g., 4TZ-ZY)	
TF	Assembled with PTFE ferrule(s)	
T	Ferrule only (e.g., 4TZ-T)	
Z6	Preset nut and ferrule(s) on tube stub end	
SPF	Silver plated ferrule(s)	Contact factory.
BP*	Bulk packed	* Indicates the quantity i.e BP50 for a fifty count package.
LWH	Lock wire hole	Contact factory.
BZP	Knurled nut	Replaces standard nut on CPI™/A-LOK® fittings for use on soft plastic tubing.
C	Silver plated nut	Replaces moly coated nut (BZ).
MI	Moly inside nut	
CNQ	Certified Nuclear Quality	
C1	Grade A Cleaning	Special cleaning, assembly, inspection and packaging for high purity applications.
C3	Cleaned for oxygen service	Meets the requirements of ASTM G93-88; Standard Practice for Cleaning Methods for Materials and Equipment used in Oxygen-Enriched Environments.
CNG	Compressed natural gas service	Assembled with a specific o-ring compound.
NIC	Nickel plated	Contact factory.
CRM	Chrome plated	Contact factory.
VO	Viton O-ring	
NC	NACE	MRO175-2003
NACE	NACE	MRO175-2002 or prior version
DFARS	Defense Acquisition Regulations System	All components and raw material must be of US origin or from an approved country. Must be reviewed by Government Compliance personnel.

NPT Male Connector
For fractional tube

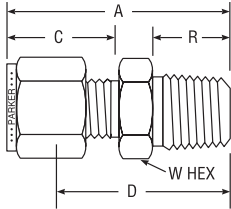
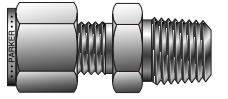

CPI™ PART NO.	A-LOK® PART NO.	INTER- CHANGES WITH	INCHES						
			TUBE O.D.	NPT PIPE THREAD	A	C	D	R	W HEX
1-1 FBZ	1MSC1N	100-1-1	1/16	1/16	.93	.43	.78	.38	5/16
1-2 FBZ	1MSC2N	100-1-2	1/16	1/8	1.03	.43	.88	.38	7/16
1-4 FBZ	1MSC4N	100-1-4	1/16	1/4	1.23	.43	1.08	.56	9/16
2-1 FBZ	2MSC1N	200-1-1	1/8	1/16	1.17	.60	.91	.38	3/8
2-2 FBZ	2MSC2N	200-1-2	1/8	1/8	1.20	.60	.94	.38	7/16
2-4 FBZ	2MSC4N	200-1-4	1/8	1/4	1.40	.60	1.14	.56	9/16
2-6 FBZ	2MSC6N	200-1-6	1/8	3/8	1.42	.60	1.16	.56	11/16
2-8 FBZ	2MSC8N	200-1-8	1/8	1/2	1.67	.60	1.41	.75	7/8
3-1 FBZ	3MSC1N	300-1-1	3/16	1/16	1.23	.64	.97	.38	7/16
3-2 FBZ	3MSC2N	300-1-2	3/16	1/8	1.23	.64	.97	.38	7/16
3-4 FBZ	3MSC4N	300-1-4	3/16	1/4	1.43	.64	1.17	.56	9/16
4-1 FBZ	4MSC1N	400-1-1	1/4	1/16	1.29	.70	1.00	.38	1/2
4-2 FBZ	4MSC2N	400-1-2	1/4	1/8	1.29	.70	1.00	.38	1/2
4-4 FBZ	4MSC4N	400-1-4	1/4	1/4	1.49	.70	1.20	.56	9/16
4-6 FBZ	4MSC6N	400-1-6	1/4	3/8	1.51	.70	1.22	.56	11/16
4-8 FBZ	4MSC8N	400-1-8	1/4	1/2	1.76	.70	1.47	.75	7/8
4-12 FBZ	4MSC12N	400-1-12	1/4	3/4	1.82	.70	1.53	.75	1-1/16
5-2 FBZ	5MSC2N	500-1-2	5/16	1/8	1.34	.73	1.05	.38	9/16
5-4 FBZ	5MSC4N	500-1-4	5/16	1/4	1.52	.73	1.23	.56	9/16
5-6 FBZ	5MSC6N	500-1-6	5/16	3/8	1.55	.73	1.25	.56	11/16
5-8 FBZ	5MSC8N	500-1-8	5/16	1/2	1.79	.73	1.5	.75	7/8
6-2 FBZ	6MSC2N	600-1-2	3/8	1/8	1.38	.76	1.09	.38	5/8
6-4 FBZ	6MSC4N	600-1-4	3/8	1/4	1.57	.76	1.28	.56	5/8
6-6 FBZ	6MSC6N	600-1-6	3/8	3/8	1.57	.76	1.28	.56	11/16
6-8 FBZ	6MSC8N	600-1-8	3/8	1/2	1.82	.76	1.53	.75	7/8
6-12 FBZ	6MSC12N	600-1-12	3/8	3/4	1.88	.76	1.59	.75	1-1/16
8-2 FBZ	8MSC2N	810-1-2	1/2	1/8	1.53	.87	1.13	.38	13/16
8-4 FBZ	8MSC4N	810-1-4	1/2	1/4	1.71	.87	1.31	.56	13/16
8-6 FBZ	8MSC6N	810-1-6	1/2	3/8	1.71	.87	1.31	.56	13/16
8-8 FBZ	8MSC8N	810-1-8	1/2	1/2	1.93	.87	1.53	.75	7/8
8-12 FBZ	8MSC12N	810-1-12	1/2	3/4	1.99	.87	1.59	.75	1-1/16
8-16 FBZ	8MSC16N	810-1-16	1/2	1	2.28	.87	1.88	.94	1-3/8
10-6 FBZ	10MSC6N	1010-1-6	5/8	3/8	1.74	.87	1.34	.56	15/16
10-8 FBZ	10MSC8N	1010-1-8	5/8	1/2	1.93	.87	1.53	.75	15/16
10-12 FBZ	10MSC12N	1010-1-12	5/8	3/4	1.99	.87	1.59	.75	1-1/16
12-8 FBZ	12MSC8N	1210-1-8	3/4	1/2	1.99	.87	1.59	.75	1-1/16
12-12 FBZ	12MSC12N	1210-1-12	3/4	3/4	1.99	.87	1.59	.75	1-1/16
12-16 FBZ	12MSC16N	1210-1-16	3/4	1	2.28	.87	1.88	.94	1-3/8
14-12 FBZ	14MSC12N	1410-1-12	7/8	3/4	1.99	.87	1.59	.75	1-3/16
14-16 FBZ	14MSC16N	1410-1-16	7/8	1	2.28	.87	1.88	.94	1-3/8
16-8 FBZ	16MSC8N	1610-1-8	1	1/2	2.27	1.05	1.78	.75	1-3/8
16-12 FBZ	16MSC12N	1610-1-12	1	3/4	2.27	1.05	1.78	.75	1-3/8
16-16 FBZ	16MSC16N	1610-1-16	1	1	2.46	1.05	1.97	.94	1-3/8
20-20 FBZ	20MSC20N	2010-1-20	1-1/4	1-1/4	3.03	1.52	2.17	.97	1-3/4
24-24 FBZ	24MSC24N	2410-1-24	1-1/2	1-1/2	3.50	1.77	2.44	1.00	2-1/8
32-32 FBZ	32MSC32N	3210-1-32	2	2	4.47	2.47	3.00	1.04	2-3/4

NOTE: A and C dimensions are typical finger-tight.

Dimensions for reference only, subject to change.

Sizes 20, 24, 32 require additional lubrication prior to assembly.

Color Coding

For easy reference, table column headings are color indicated as follows:

fractional



metric



NPT Male Connector
 For metric tube

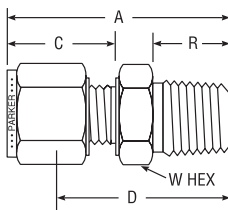
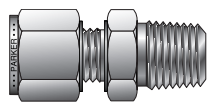

CPI™ PART NO.	A-LOK® PART NO.	INTER- CHANGES WITH	MILLIMETERS						
			TUBE O.D.	NPT PIPE THREAD	A	C	D	R	W HEX
FBZ 2-1/8	M2MSC1/8N	2MO-1-2	2	1/8	29,7	15,3	23,1	9,5	12,0
FBZ 3-1/8	M3MSC1/8N	3MO-1-2	3	1/8	29,7	15,3	23,1	9,5	12,0
FBZ 3-1/4	M3MSC1/4N	3MO-1-4	3	1/4	35,3	15,3	28,7	14,3	14,0
FBZ 4-1/8	M4MSC1/8N	4MO-1-2	4	1/8	31,2	16,1	24,6	9,5	12,0
FBZ 4-1/4	M4MSC1/4N	4MO-1-4	4	1/4	36,3	16,1	29,7	14,3	14,0
FBZ 6-1/8	M6MSC1/8N	6MO-1-2	6	1/8	32,9	17,7	25,4	9,5	14,0
FBZ 6-1/4	M6MSC1/4N	6MO-1-4	6	1/4	38,1	17,7	30,6	14,3	14,0
FBZ 6-3/8	M6MSC3/8N	6MO-1-6	6	3/8	38,5	17,7	31,0	14,3	18,0
FBZ 6-1/2	M6MSC1/2N	6MO-1-8	6	1/2	44,8	17,7	37,3	19,1	22,0
FBZ 8-1/8	M8MSC1/8N	8MO-1-2	8	1/8	34,2	18,6	26,7	9,5	15,0
FBZ 8-1/4	M8MSC1/4N	8MO-1-4	8	1/4	38,8	18,6	31,3	14,3	15,0
FBZ 8-3/8	M8MSC3/8N	8MO-1-6	8	3/8	39,3	18,6	31,8	14,3	18,0
FBZ 8-1/2	M8MSC1/2N	8MO-1-8	8	1/2	45,6	18,6	38,1	19,1	22,0
FBZ 10-1/8	M10MSC1/8N	10MO-1-2	10	1/8	36,1	19,5	28,6	9,5	18,0
FBZ 10-1/4	M10MSC1/4N	10MO-1-4	10	1/4	40,9	19,5	33,3	14,3	18,0
FBZ 10-3/8	M10MSC3/8N	10MO-1-6	10	3/8	40,9	19,5	33,3	14,3	18,0
FBZ 10-1/2	M10MSC1/2N	10MO-1-8	10	1/2	47,5	19,5	38,9	19,1	22,0
FBZ 10-3/4	M10MSC3/4N	10MO-1-12	10	3/4	46,4	19,5	38,9	19,1	27,0
FBZ 10-1	M10MSC1N	10MO-1-16	10	1	55,0	19,5	47,5	23,8	35,0
FBZ 12-1/4	M12MSC1/4N	12MO-1-4	12	1/4	43,4	22,0	33,3	14,3	22,0
FBZ 12-3/8	M12MSC3/8N	12MO-1-6	12	3/8	43,4	22,0	33,3	14,3	22,0
FBZ 12-1/2	M12MSC1/2N	12MO-1-8	12	1/2	49,0	22,0	38,9	19,1	22,0
FBZ 12-3/4	M12MSC3/4N	12MO-1-12	12	3/4	50,5	22,0	40,4	19,1	27,0
FBZ 14-1/4	M14MSC1/4N	14MO-1-4	14	1/4	44,2	22,0	34,1	14,3	24,0
FBZ 14-3/8	M14MSC3/8N	14MO-1-6	14	3/8	44,2	22,0	34,1	14,3	24,0
FBZ 14-1/2	M14MSC1/2N	14MO-1-8	14	1/2	49,0	22,0	38,9	19,1	24,0
FBZ 15-1/2	M15MSC1/2N	15MO-1-8	15	1/2	49,0	22,0	38,9	19,1	24,0
FBZ 16-3/8	M16MSC3/8N	16MO-1-6	16	3/8	44,1	22,0	34,01	14,3	24,0
FBZ 16-1/2	M16MSC1/2N	16MO-1-8	16	1/2	49,0	22,0	38,9	19,1	24,0
FBZ 16-3/4	M16MSC3/4N	16MO-1-12	16	3/4	50,5	22,0	40,5	19,1	27,0
FBZ 18-1/2	M18MSC1/2N	18MO-1-8	18	1/2	50,6	22,0	40,5	19,1	27,0
FBZ 18-3/4	M18MSC3/4N	18MO-1-12	18	3/4	50,6	22,0	40,5	19,1	27,0
FBZ 20-1/2	M20MSC1/2N	20MO-1-8	20	1/2	50,6	22,0	42,2	19,1	30,0
FBZ 20-3/4	M20MSC3/4N	20MO-1-12	20	3/4	52,3	22,0	42,2	19,1	30,0
FBZ 20-1	M20MSC1N	20MO-1-16	20	1	57,7	22,0	47,6	23,8	35,0
FBZ 22-3/4	M22MSC3/4N	22MO-1-12	22	3/4	52,3	22,0	42,2	19,1	35,0
FBZ 24-1/2	M25MSC1/2N	25MO-1-8	25	1/2	57,5	26,5	45,3	19,1	35,0
FBZ 25-3/4	M25MSC3/4N	25MO-1-12	25	3/4	57,5	26,5	45,2	19,1	35,0
FBZ 25-1	M25MSC1N	25MO-1-16	25	1	62,3	26,5	50,0	23,8	35,0

NOTE: A and C dimensions are typical finger-tight.

Dimensions for reference only, subject to change.

BSP Taper Male Connector
For fractional tube

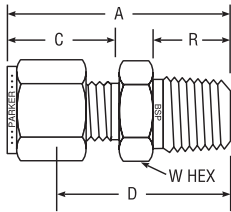
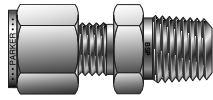

CPI™ PART NO.	A-LOK® PART NO.	INTER- CHANGES WITH	INCHES							
			TUBE O. D.	BSPT THREAD	A	C	D	R	W HEX	BORE
2-2K FBZ	2MSC2K	200-1-2RT	1/8	1/8	1.20	.60	0.94	.38	7/16	.19
2-4K FBZ	2MSC4K	200-1-4RT	1/8	1/4	1.40	.60	1.14	.56	9/16	.19
4-2K FBZ	4MSC2K	400-1-2RT	1/4	1/8	1.30	.70	1.00	.38	1/2	.19
4-4K FBZ	4MSC4K	400-1-4RT	1/4	1/4	1.50	.70	1.20	.56	9/16	.19
4-6K FBZ	4MSC6K	400-1-6RT	1/4	3/8	1.52	.70	1.22	.56	11/16	.19
4-8K FBZ	4MSC8K	400-1-8RT	1/4	1/2	1.77	.70	1.47	.75	7/8	.19
5-2K FBZ	5MSC2K	500-1-2RT	5/16	1/8	1.34	.73	1.05	.38	9/16	.19
5-4K FBZ	5MSC4K	500-1-4RT	5/16	1/4	1.52	.73	1.23	.56	9/16	.19
6-2K FBZ	6MSC2K	600-1-2RT	3/8	1/8	1.39	.76	1.09	.38	5/8	.19
6-4K FBZ	6MSC4K	600-1-4RT	3/8	1/4	1.57	.76	1.28	.56	11/16	.28
6-6K FBZ	6MSC6K	600-1-6RT	3/8	3/8	1.57	.76	1.28	.56	11/16	.28
6-8K FBZ	6MSC8K	600-1-8RT	3/8	1/2	1.82	.76	1.53	.75	7/8	.28
8-4K FBZ	8MSC4K	810-1-4RT	1/2	1/4	1.69	.86	1.31	.56	13/16	.28
8-6K FBZ	8MSC6K	810-1-6RT	1/2	3/8	1.69	.86	1.31	.56	13/16	.38
8-8K FBZ	8MSC8K	810-1-8RT	1/2	1/2	1.91	.66	1.53	.75	7/8	.41

NOTE: A and C dimensions are typical finger-tight.

Dimensions for reference only, subject to change.

BSP Taper Male Connector
For metric tube

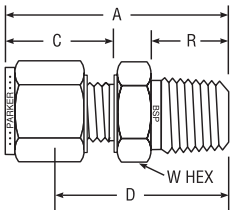
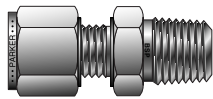

CPI™ PART NO.	A-LOK® PART NO.	INTER- CHANGES WITH	MILLIMETERS						
			TUBE O. D.	BSPT THREAD	A	C	D	R	W HEX
FBZ 2-1/8K	M2MSC1/8K	2MO-1-2RT	2	1/8	29,7	15,3	23,1	9,5	12,0
FBZ 3-1/8K	M3MSC1/8K	3MO-1-2RT	3	1/8	29,7	15,3	23,1	9,7	12,0
FBZ 3-1/4K	M3MSC1/4K	3MO-1-4RT	3	1/4	35,3	15,3	28,7	14,2	14,0
FBZ 4-1/8K	M4MSC1/8K	4MO-1-2RT	4	1/8	31,2	16,1	24,6	9,7	12,0
FBZ 4-1/4K	M4MSC1/4K	4MO-1-4RT	4	1/4	36,3	16,1	29,7	14,2	14,0
FBZ 6-1/8K	M6MSC1/8K	6MO-1-2RT	6	1/8	32,9	17,7	25,4	9,7	14,0
FBZ 6-1/4K	M6MSC1/4K	6MO-1-4RT	6	1/4	40,0	17,7	30,5	14,2	14,0
FBZ 6-3/8K	M6MSC3/8K	6MO-1-6RT	6	3/8	38,5	17,7	31,0	14,2	18,0
FBZ 6-1/2K	M6MSC1/2K	6MO-1-8RT	6	1/2	45,6	17,7	38,1	19,1	22,0
FBZ 8-1/8K	M8MSC1/8K	8MO-1-2RT	8	1/8	33,9	18,6	26,4	9,5	15,0
FBZ 8-1/4K	M8MSC1/4K	8MO-1-4RT	8	1/4	38,7	18,6	31,2	14,2	15,0
FBZ 8-3/8K	M8MSC3/8K	8MO-1-6RT	8	3/8	39,3	18,6	31,8	14,2	18,0
FBZ 8-1/2K	M8MSC1/2K	8MO-1-8RT	8	1/2	45,6	18,6	38,1	19,1	22,0
FBZ 10-1/8K	M10MSC1/8K	10MO-1-2RT	10	1/8	36,2	19,5	28,6	9,5	18,0
FBZ 10-1/4K	M10MSC1/4K	10MO-1-4RT	10	1/4	40,9	19,5	33,3	14,2	18,0
FBZ 10-3/8K	M10MSC3/8K	10MO-1-6RT	10	3/8	40,9	19,5	33,3	14,2	18,0
FBZ 10-1/2K	M10MSC1/2K	10MO-1-8RT	10	1/2	46,5	19,5	38,9	19,1	22,0
FBZ 12-1/4K	M12MSC1/4K	12MO-1-4RT	12	1/4	43,4	22,0	33,3	14,2	22,0
FBZ 12-3/8K	M12MSC3/8K	12MO-1-6RT	12	3/8	43,4	22,0	33,3	14,2	22,0
FBZ 12-1/2K	M12MSC1/2K	12MO-1-8RT	12	1/2	49,0	22,0	38,9	19,1	22,0
FBZ 12-3/4K	M12MSC3/4K	12MO-1-12RT	12	3/4	49,5	22,0	40,4	19,1	27,0
FBZ 15-1/2K	M15MSC1/2K	15MO-1-8RT	15	1/2	49,0	22,0	38,9	19,1	24,0
FBZ 16-3/8K	M16MSC3/8K	16MO-1-6RT	16	3/8	44,2	22,0	34,1	14,2	24,0
FBZ 16-1/2K	M16MSC1/2K	16MO-1-8RT	16	1/2	49,0	22,0	38,9	19,1	24,0
FBZ 16-3/4K	M16MSC3/4K	16MO-1-12RT	16	3/4	49,5	22,0	40,5	19,1	27,0
FBZ 18-1/2K	M18MSC1/2K	18MO-1-8RT	18	1/2	50,6	22,0	40,4	19,1	27,0
FBZ 18-3/4K	M18MSC3/4K	18MO-1-12RT	18	3/4	50,6	22,0	40,4	19,1	27,0
FBZ 20-1/2K	M20MSC1/2K	20MO-1-8RT	20	1/2	52,3	22,0	42,2	19,1	30,0
FBZ 20-3/4K	M20MSC3/4K	20MO-1-12RT	20	3/4	52,3	22,0	42,2	19,1	30,0
FBZ 22-3/4K	M22MSC3/4K	22MO-1-12RT	22	3/4	52,3	22,0	42,2	19,1	30,0
FBZ 25-3/4K	M25MSC3/4K	25MO-1-12RT	25	3/4	57,5	26,5	45,2	19,1	35,0
FBZ 25-1K	M25MSC1K	25MO-1-16RT	25	1	62,3	26,5	50,0	23,9	35,0

NOTE: A and C dimensions are typical finger-tight.

Dimensions for reference only, subject to change.

Color Coding

For easy reference, table column headings are color indicated as follows:

fractional



metric



BSPP Male Connector For fractional tube

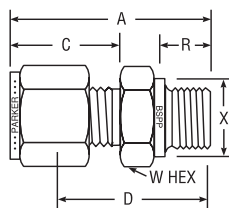
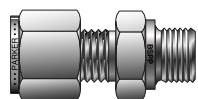

CPI™ PART NO.	A-LOK® PART NO.	INTER- CHANGES WITH	INCHES								
			TUBE O. D.	BSPP THREAD	A	C	D	R	X	W HEX	BORE
2-2R FBZ	2MSC2R	200-1-2RS	1/8	1/8	1.18	.60	0.92	.28	0.54	9/16	.16
2-4R FBZ	2MSC4R	200-1-4RS	1/8	1/4	1.27	.60	1.13	.44	0.70	3/4	.09
2-6R FBZ	2MSC6R	200-1-6RS	1/8	3/8	1.46	.60	1.17	.44	0.86	7/8	.28
4-2R FBZ	4MSC2R	400-1-2RS	1/4	1/8	1.28	.70	0.98	.28	0.54	9/16	.16
4-4R FBZ	4MSC4R	400-1-4RS	1/4	1/4	1.49	.70	1.19	.44	0.70	3/4	.19
4-6R FBZ	4MSC6R	400-1-6RS	1/4	3/8	1.55	.70	1.25	.44	0.86	7/8	.19
4-8R FBZ	4MSC8R	400-1-8RS	1/4	1/2	1.77	.70	1.47	.56	1.01	1-1/16	.19
6-2R FBZ	6MSC2R	600-1-2RS	3/8	1/8	1.35	.76	1.06	.28	0.54	5/8	.16
6-4R FBZ	6MSC4R	600-1-4RS	3/8	1/4	1.54	.76	1.25	.44	0.70	3/4	.25
6-6R FBZ	6MSC6R	600-1-6RS	3/8	3/8	1.57	.76	1.28	.44	0.86	7/8	.28
6-8R FBZ	6MSC8R	600-1-8RS	3/8	1/2	1.82	.76	1.53	.56	1.01	1-1/16	.28
8-4R FBZ	8MSC4R	810-1-4RS	1/2	1/4	1.66	.86	1.28	.44	0.70	13/16	.25
8-6R FBZ	8MSC6R	810-1-6RS	1/2	3/8	1.69	.86	1.31	.44	0.86	7/8	.31
8-8R FBZ	8MSC8R	810-1-8RS	1/2	1/2	1.91	.86	1.53	.56	1.01	1-1/16	.41
12-8R FBZ	12MSC8R	1210-1-8RS	3/4	1/2	1.93	.86	1.53	.56	1.01	1-1/16	.41
12-12R FBZ	12MSC12R	1210-1-12RS	3/4	3/4	2.07	.86	1.69	.63	1.25	1-3/8	.63
16-8R FBZ	16MSC8R	1610-1-8RS	1	1/2	2.21	1.04	1.72	.56	1.01	1-3/8	.41
16-16R FBZ	16MSC16R	1610-1-16RS	1	1	2.35	1.04	1.88	.72	1.52	1-5/8	.88

NOTE: A and C dimensions are typical finger-tight. Dimensions for reference only, subject to change.

Sealing washer must be used with BSPP end shown ISO228/1 (Form A). See page 76.
 For Form B undercut change part number and add B before R. e.g. M6MSC1/4BR.

BSPP Male Connector For metric tube

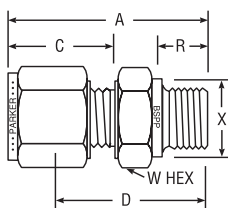
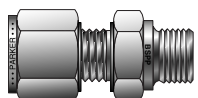

CPI™ PART NO.	A-LOK® PART NO.	INTER-CHANGES WITH	MILLIMETERS								
			TUBE O. D.	BSPP THREAD	A	C	D	R	X	W HEX	
FBZ 2-1/8R	M2MSC1/8R	2MO-1-2RS	2	1/8	28,4	15,3	21,8	7,1	14,0	13,7	13,7
FBZ 3-1/8R	M3MSC1/8R	3MO-1-2RS	3	1/8	30,0	15,3	23,4	7,1	13,7	14,0	14,0
FBZ 3-1/4R	M3MSC1/4R	3MO-1-4RS	3	1/4	35,3	15,3	28,7	11,2	17,8	19,0	19,0
FBZ 6-1/8R	M6MSC1/8R	6MO-1-2RS	6	1/8	32,5	17,7	25,0	7,1	13,7	14,0	14,0
FBZ 6-1/4R	M6MSC1/4R	6MO-1-4RS	6	1/4	37,7	17,7	30,2	11,2	17,8	19,0	19,0
FBZ 6-3/8R	M6MSC3/8R	6MO-1-6RS	6	3/8	39,0	17,7	31,5	11,2	21,8	22,0	22,0
FBZ 6-1/2R	M6MSC1/2R	6MO-1-8RS	6	1/2	45,6	17,7	38,1	14,2	25,7	27,0	27,0
FBZ 8-1/8R	M8MSC1/8R	8MO-1-2RS	8	1/8	33,1	18,6	25,6	7,1	15,0	13,7	13,7
FBZ 8-1/4R	M8MSC1/4R	8MO-1-4RS	8	1/4	38,5	18,6	31,0	11,2	17,8	19,0	19,0
FBZ 8-3/8R	M8MSC3/8R	8MO-1-6RS	8	3/8	39,8	18,6	32,3	11,2	21,8	22,0	22,0
FBZ 8-1/2R	M8MSC1/2R	8MO-1-8RS	8	1/2	45,6	18,6	38,1	14,2	25,7	27,0	27,0
FBZ 10-1/4R	M10MSC1/4R	10MO-1-4RS	10	1/4	39,4	19,5	31,8	11,2	17,8	19,0	19,0
FBZ 10-3/8R	M10MSC3/8R	10MO-1-6RS	10	3/8	40,6	19,5	33,0	11,2	21,8	22,0	22,0
FBZ 10-1/2R	M10MSC1/2R	10MO-1-8RS	10	1/2	46,5	19,5	38,9	14,2	25,7	27,0	27,0
FBZ 12-1/4R	M12MSC1/4R	12MO-1-4RS	12	1/4	42,6	22,0	32,5	11,2	17,8	22,0	22,0
FBZ 12-3/8R	M12MSC3/8R	12MO-1-6RS	12	3/8	43,1	22,0	33,0	11,2	21,8	22,0	22,0
FBZ 12-1/2R	M12MSC1/2R	12MO-1-8RS	12	1/2	49,0	22,0	38,9	14,2	25,7	27,0	27,0
FBZ 12-3/4R	M12MSC3/4R	12MO-1-12RS	12	3/4	52,8	22,0	42,7	16,0	31,8	35,0	35,0
FBZ 16-3/8R	M16MSC3/8R	16MO-1-6RS	16	3/8	43,5	22,0	33,4	11,2	22,0	21,8	21,8
FBZ 16-1/2R	M16MSC1/2R	16MO-1-8RS	16	1/2	49,0	22,0	38,9	14,2	26,0	27,0	27,0
FBZ 18-1/2R	M18MSC1/2R	18MO-1-8RS	18	1/2	49,0	22,0	38,9	14,2	26,0	27,0	27,0
FBZ 18-3/4R	M18MSC3/4R	18MO-1-12RS	18	3/4	53,1	22,0	43,0	16,0	35,0	32,0	32,0
FBZ 20-1/2R	M20MSC1/2R	20MO-1-8RS	20	1/2	50,5	22,0	40,4	14,2	30,0	25,7	25,7
FBZ 20-3/4R	M20MSC3/4R	20MO-1-12RS	20	3/4	52,8	22,0	42,7	16,0	32,0	35,0	35,0
FBZ 22-3/4R	M22MSC3/4R	22MO-1-12RS	22	3/4	52,8	22,0	42,7	16,0	32,0	35,0	35,0
FBZ 25-3/4R	M25MSC3/4R	25MO-1-12RS	25	3/4	59,8	26,5	47,6	16,0	35,0	31,8	31,8
FBZ 25-1R	M25MSC1R	25MO-1-16RS	25	1	60,1	26,5	47,8	18,3	39,0	41,0	41,0

NOTE: A and C dimensions are typical finger-tight. Dimensions for reference only, subject to change.

Sealing washer must be used with BSPP end shown ISO228/1 (Form A). See page 76.
 For Form B undercut, add a "B" before the "R." e.g. M6MSC1/4BR.

BSPP Male Connector with ED Seal
For fractional tube

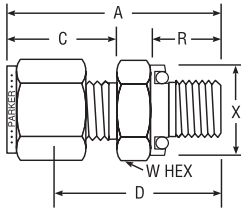
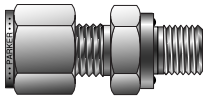

CPI™ PART NO.	A-LOK® PART NO.	INTER- CHANGES WITH	INCHES								
			TUBE O.D.	BSPP THREAD	A	C	D	R	X	W HEX	BORE
4-4R-ED FBZ	4MSC4R-ED	—	1/4	1/4	1.48	.70	1.19	.47	.74	3/4	.19
4-8R-ED FBZ	4MSC8R-ED	—	1/4	1/2	1.76	.70	1.38	.55	1.04	1-1/16	.19
6-6R-ED FBZ	6MSC6R-ED	—	3/8	3/8	1.60	.76	1.31	.47	.86	7/8	.28
8-4R-ED FBZ	8MSC4R-ED	—	1/2	1/4	1.69	.86	1.31	.47	.74	13/16	.25
8-6R-ED FBZ	8MSC6R-ED	—	1/2	3/8	1.69	.86	1.31	.47	.86	7/8	.31
8-8R-ED FBZ	8MSC8R-ED	—	1/2	1/2	1.85	.86	1.47	.55	1.04	1-1/16	.41
12-12R-ED FBZ	12MSC12R-ED	—	3/4	3/4	1.98	.86	1.59	.63	1.25	1-5/16	.63

NOTE: A and C dimensions are typical finger-tight.

Dimensions for reference only, subject to change.

ED fittings are supplied with sealing washers in nitrile as standard, suitable for temperatures of between -35°C and +100°C (-31°F to +212°F). Fluorocarbon seals are available upon request which are suitable for temperatures of between -25°C and +120°C (-13°F to +248°F).

Male Connector with ED Seal
For metric tube

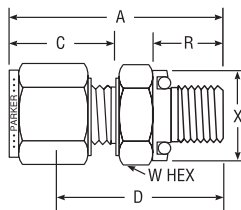
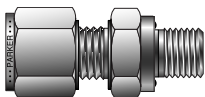

CPI™ PART NO.	A-LOK® PART NO.	INTER- CHANGES WITH	MILLIMETERS								
			TUBE O.D.	BSPP THREAD	A	C	D	R	X	W HEX	
FBZ6-1/8R-ED	M6MSC1/8R-ED	—	6	1/8	32,5	17,7	25,0	7,9	13,7	14,0	
FBZ6-1/4R-ED	M6MSC1/4R-ED	—	6	1/4	38,2	17,7	30,7	11,9	18,8	19,0	
FBZ6-3/8R-ED	M6MSC3/8R-ED	—	6	3/8	39,5	17,7	32,0	11,9	21,8	22,0	
FBZ6-1/2R-ED	M6MSC1/2R-ED	—	6	1/2	44,5	17,7	37,0	14,0	26,4	27,0	
FBZ10-1/4R-ED	M10MSC1/4R-ED	—	10	1/4	40,0	19,5	32,3	11,9	18,8	19,0	
FBZ10-3/8R-ED	M10MSC3/8R-ED	—	10	3/8	41,1	19,5	38,1	11,9	21,8	22,0	
FBZ10-1/2R-ED	M10MSC1/2R-ED	—	10	1/2	46,0	19,5	38,4	14,0	26,4	27,0	
FBZ12-1/4R-ED	M12MSC1/4R-ED	—	12	1/4	43,1	22,0	33,0	11,9	18,8	22,0	
FBZ12-3/8R-ED	M12MSC3/8R-ED	—	12	3/8	43,6	22,0	33,5	11,9	21,8	22,0	
FBZ12-1/2R-ED	M12MSC1/2R-ED	—	12	1/2	48,5	22,0	38,4	14,0	26,4	27,0	

NOTE: A and C dimensions are typical finger-tight.

Dimensions for reference only, subject to change.

ED fittings are supplied with sealing washers in nitrile as standard, suitable for temperatures of between -35°C and +100°C (-31°F to +212°F). Fluorocarbon seals are available upon request which are suitable for temperatures of between -25°C and +120°C (-13°F to +248°F).

Color Coding

For easy reference, table column headings are color indicated as follows:

fractional



metric



NPT Male Bulkhead Connector
 For fractional tube

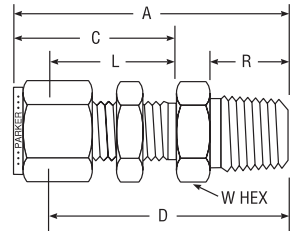
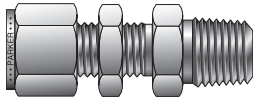

CPI™ PART NO.	A-LOK® PART NO.	INTER- CHANGES WITH	INCHES							
			TUBE O.D.	NPT PIPE THREAD	A	C	D	L	R	W HEX
1-1 FH2BZ	1MBC1N	100-11-1	1/16	1/16	1.19	0.68	1.038	.53	.38	5/16
1-2 FH2BZ	1MBC2N	100-11-2	1/16	1/8	1.27	0.68	1.116	.53	.38	7/16
2-2 FH2BZ	2MBC2N	200-11-2	1/8	1/8	1.83	1.23	1.571	.97	.38	1/2
3-2 FH2BZ	3MBC2N	300-11-2	3/16	1/8	1.89	1.26	1.634	1.00	.38	9/16
4-2 FH2BZ	4MBC2N	400-11-2	1/4	1/8	1.95	1.31	1.655	1.02	.38	5/8
4-4 FH2BZ	4MBC4N	400-11-4	1/4	1/4	2.132	1.31	1.842	1.02	.56	5/8
4-6 FH2BZ	4MBC6N	400-11-6	1/4	3/8	2.162	1.31	1.872	1.02	.56	11/16
4-8 FH2BZ	4MBC8N	400-11-8	1/4	1/2	2.374	1.31	2.084	1.02	.75	7/8
5-2 FH2BZ	5MBC2N	500-11-2	5/16	1/8	2.08	1.42	1.779	1.12	.38	11/16
5-4 FH2BZ	5MBC4N	500-11-4	5/16	1/4	2.27	1.42	1.966	1.12	.56	11/16
6-2 FH2BZ	6MBC2N	600-11-2	3/8	1/8	2.08	1.44	1.788	1.15	.38	3/4
6-4 FH2BZ	6MBC4N	600-11-4	3/8	1/4	2.265	1.44	1.975	1.15	.56	3/4
6-6 FH2BZ	6MBC6N	600-11-6	3/8	3/8	2.265	1.44	1.975	1.15	.56	3/4
6-8 FH2BZ	6MBC8N	600-11-8	3/8	1/2	2.48	1.44	2.219	1.15	.75	7/8
8-4 FH2BZ	8MBC4N	810-11-4	1/2	1/4	2.494	1.65	2.094	1.25	.56	15/16
8-6 FH2BZ	8MBC6N	810-11-6	1/2	3/8	2.494	1.65	2.094	1.25	.56	15/16
8-8 FH2BZ	8MBC8N	810-11-8	1/2	1/2	2.712	1.65	2.312	1.25	.75	15/16
8-12 FH2BZ	8MBC12N	810-11-12	1/2	3/4	2.722	1.65	2.322	1.25	.75	1-1/8
10-6 FH2BZ	10MBC6N	1010-11-6	5/8	3/8	2.628	1.68	2.228	1.28	.56	1-1/16
10-8 FH2BZ	10MBC8N	1010-11-8	5/8	1/2	2.816	1.68	2.416	1.28	.75	1-1/16
12-8 FH2BZ	12MBC8N	1210-11-8	3/4	1/2	3.00	1.87	2.601	1.47	.75	1-3/16
12-12 FH2BZ	12MBC12N	1210-11-12	3/4	3/4	3.00	1.87	2.601	1.47	.75	1-3/16
14-12 FH2BZ	14MBC12N	1410-11-12	7/8	3/4	3.31	2.09	2.913	1.69	.75	1-3/8
16-12 FH2BZ	16MBC12N	1610-11-12	1	3/4	3.54	2.27	3.006	1.78	.75	1-5/8
16-16 FH2BZ	16MBC16N	1610-11-16	1	1	3.72	2.27	3.194	1.78	.94	1-5/8

NOTE: A and C dimensions are typical finger-tight.

Dimensions for reference only, subject to change.

For bulkhead hole drill size and maximum bulkhead thickness, see page 32, Part BC.

NPT Male Bulkhead Connector
 For metric tube

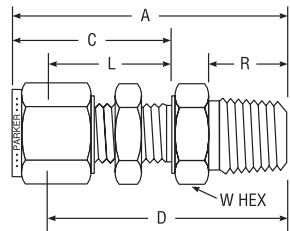
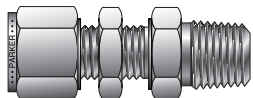

CPI™ PART NO.	A-LOK® PART NO.	INTER- CHANGES WITH	MILLIMETERS									
			TUBE O.D.	NPT THREAD	A	C	D	L	R	W HEX	B'HEAD HOLE DRILL SIZE	MAX. B'HEAD THICK.
FH2BZ 6-1/8	M6MBC1/8N	6MO-11-2	6	1/8	49,6	33,7	42,1	26,2	9,5	16,0	11,5	10,2
FH2BZ 6-1/4	M6MBC1/4N	6MO-11-4	6	1/4	53,5	33,7	46,0	26,2	14,3	16,0	11,5	10,2
FH2BZ 8-1/8	M8MBC1/8N	8MO-11-2	8	1/8	52,3	36,0	44,8	28,5	9,5	18,0	13,1	11,2
FH2BZ 8-1/4	M8MBC1/4N	8MO-11-4	8	1/4	57,5	36,0	50,0	28,5	14,3	18,0	13,1	11,2
FH2BZ 10-1/4	M10MBC1/4N	10MO-11-4	10	1/4	58,4	37,0	50,8	29,4	14,3	22,0	16,3	11,2
FH2BZ 10-3/8	M10MBC3/8N	10MO-11-6	10	3/8	58,4	37,0	50,8	29,4	14,3	22,0	16,3	11,2
FH2BZ 10-1/2	M10MBC1/2N	10MO-11-8	10	1/2	63,1	37,0	55,5	29,4	19,0	22,0	16,3	11,2
FH2BZ 12-1/4	M12MBC1/4N	12MO-11-4	12	1/4	63,3	10,1	53,2	31,8	14,3	24,0	19,5	12,7
FH2BZ 12-3/8	M12MBC3/8N	12MO-11-6	12	3/8	64,5	10,1	54,4	31,8	14,3	24,0	19,5	12,7
FH2BZ 12-1/2	M12MBC1/2N	12MO-11-8	12	1/2	67,5	10,1	57,4	31,8	19,0	24,0	19,5	12,7

NOTE: A and C dimensions are typical finger-tight.

Dimensions for reference only, subject to change.

Thermocouple Connector For fractional tube

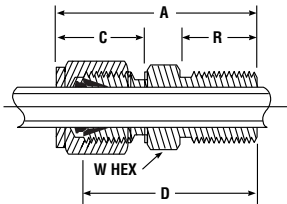
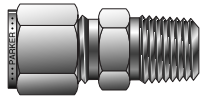

CPI™ PART NO.	A-LOK® PART NO.	INTER- CHANGES WITH	INCHES						
			TUBE O. D.	NPT PIPE THREAD	A	C	D	R	W HEX
1-1 FH4BZ	1MTC1N	100-1-1BT	1/16	1/16	0.93	.43	0.78	.38	5/16
1-2 FH4BZ	1MTC2N	100-1-2BT	1/16	1/8	1.03	.43	0.88	.38	7/16
1-4 FH4BZ	1MTC4N	100-1-4BT	1/16	1/4	1.23	.43	1.08	.56	9/16
2-1 FH4BZ	2MTC1N	200-1-1BT	1/8	1/16	1.17	.60	0.91	.38	3/8
2-2 FH4BZ	2MTC2N	200-1-2BT	1/8	1/8	1.20	.60	0.94	.38	7/16
2-4 FH4BZ	2MTC4N	200-1-4BT	1/8	1/4	1.40	.60	1.14	.56	9/16
3-2 FH4BZ	3MTC2N	300-1-2BT	3/16	1/8	1.23	.64	0.97	.38	7/16
3-4 FH4BZ	3MTC4N	300-1-4BT	3/16	1/4	1.43	.64	1.17	.56	9/16
4-2 FH4BZ	4MTC2N	400-1-2BT	1/4	1/8	1.29	.70	1.00	.38	1/2
4-4 FH4BZ	4MTC4N	400-1-4BT	1/4	1/4	1.49	.70	1.20	.56	9/16
4-6 FH4BZ	4MTC6N	400-1-6BT	1/4	3/8	1.60	.70	1.22	.56	11/16
4-8 FH4BZ	4MTC8N	400-1-8BT	1/4	1/2	1.87	.70	1.47	.75	7/8
5-4 FH4BZ	5MTC4N	500-1-4BT	5/16	1/4	1.52	.73	1.22	.56	9/16
6-4 FH4BZ	6MTC4N	600-1-4BT	3/8	1/4	1.57	.76	1.28	.56	5/8
6-6 FH4BZ	6MTC6N	600-1-6BT	3/8	3/8	1.57	.76	1.28	.56	11/16
6-8 FH4BZ	6MTC8N	600-1-8BT	3/8	1/2	1.82	.76	1.53	.75	7/8
6-12 FH4BZ	6MTC12N	600-1-12BT	3/8	3/4	1.88	.76	1.59	.75	1-1/16
8-8 FH4BZ	8MTC8N	810-1-8BT	1/2	1/2	1.93	.87	1.53	.76	7/8
8-12 FH4BZ	8MTC12N	810-1-12BT	1/2	3/4	1.99	.87	1.59	.75	1-1/16
10-12 FH4BZ	10MTC12N	1010-1-12BT	5/8	3/4	1.99	.87	1.59	.75	1-1/16
12-12 FH4BZ	12MTC12N	1210-1-12BT	3/4	3/4	1.99	.87	1.59	.75	1-1/16
16-16 FH4BZ	16MTC16N	1610-1-16BT	1	1	2.46	1.05	1.97	.94	1-3/8

NOTE: A and C dimensions are typical finger-tight.

Dimensions for reference only, subject to change.

NPT Male Elbow For fractional tube

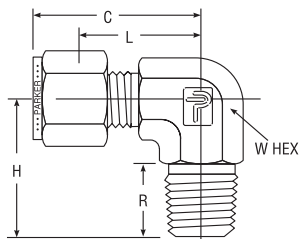
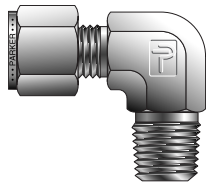

CPI™ PART NO.	A-LOK® PART NO.	INTER- CHANGES WITH	INCHES						
			TUBE O. D.	NPT PIPE THREAD	C	H	L	R	W HEX
1-1 CBZ	1MSEL1N	100-2-1	1/16	1/16	.75	0.70	.60	.38	7/16
1-2 CBZ	1MSEL2N	100-2-2	1/16	1/8	.75	0.70	.60	.38	7/16
2-1 CBZ	2MSEL1N	200-2-1	1/8	1/16	.93	0.70	.67	.38	7/16
2-2 CBZ	2MSEL2N	200-2-2	1/8	1/8	.93	0.70	.67	.38	7/16
2-4 CBZ	2MSEL4N	200-2-4	1/8	1/4	.97	0.93	.72	.56	9/16
3-2 CBZ	3MSEL2N	300-2-2	3/16	1/8	1.00	0.74	.74	.38	1/2
3-4 CBZ	3MSEL4N	300-2-4	3/16	1/4	1.00	0.93	.74	.56	9/16
4-1 CBZ	4MSEL1N	400-2-1	1/4	1/16	1.06	0.74	.77	.38	1/2
4-2 CBZ	4MSEL2N	400-2-2	1/4	1/8	1.06	0.74	.77	.38	1/2
4-4 CBZ	4MSEL4N	400-2-4	1/4	1/4	1.06	0.93	.77	.56	9/16
4-6 CBZ	4MSEL6N	400-2-6	1/4	3/8	1.17	1.04	.88	.56	11/16
4-8 CBZ	4MSEL8N	400-2-8	1/4	1/2	1.25	1.31	.96	.75	13/16
5-2 CBZ	5MSEL2N	500-2-2	5/16	1/8	1.13	0.79	.84	.38	9/16
5-4 CBZ	5MSEL4N	500-2-4	5/16	1/4	1.13	0.97	.84	.56	9/16
6-2 CBZ	6MSEL2N	600-2-2	3/8	1/8	1.20	0.82	.91	.38	5/8
6-4 CBZ	6MSEL4N	600-2-4	3/8	1/4	1.20	1.01	.91	.56	5/8
6-6 CBZ	6MSEL6N	600-2-6	3/8	3/8	1.23	1.13	.97	.56	11/16
6-8 CBZ	6MSEL8N	600-2-8	3/8	1/2	1.31	1.31	1.02	.75	13/16
6-12 CBZ	6MSEL12N	600-2-12	3/8	3/4	1.46	1.46	1.17	.75	1-1/16
8-4 CBZ	8MSEL4N	810-2-4	1/2	1/4	1.42	1.12	1.02	.56	13/16
8-6 CBZ	8MSEL6N	810-2-6	1/2	3/8	1.42	1.12	1.02	.56	13/16
8-8 CBZ	8MSEL8N	810-2-8	1/2	1/2	1.42	1.31	1.02	.75	13/16
8-12 CBZ	8MSEL12N	810-2-12	1/2	3/4	1.57	1.46	1.17	.75	1-1/16
10-6 CBZ	10MSEL6N	1010-2-6	5/8	3/8	1.50	1.20	1.10	.56	15/16
10-8 CBZ	10MSEL8N	1010-2-8	5/8	1/2	1.50	1.39	1.10	.75	15/16
10-12 CBZ	10MSEL12N	1010-2-12	5/8	3/4	1.57	1.46	1.17	.75	1-1/16
12-8 CBZ	12MSEL8N	1210-2-8	3/4	1/2	1.57	1.46	1.17	.75	1-1/16
12-12 CBZ	12MSEL12N	1210-2-12	3/4	3/4	1.57	1.46	1.17	.75	1-1/16
14-12 CBZ	14MSEL12N	1410-2-12	7/8	3/4	1.76	1.65	1.36	.75	1-3/8
16-12 CBZ	16MSEL12N	1610-2-12	1	3/4	1.93	1.65	1.45	.75	1-3/8
16-16 CBZ	16MSEL16N	1610-2-16	1	1	1.93	1.84	1.45	.94	1-3/8
20-20 CBZ	20MSEL20N	2010-2-20	1-1/4	1-1/4	2.61	1.88	1.75	.97	1-5/8
24-24 CBZ	24MSEL24N	2410-2-24	1-1/2	1-1/2	3.06	2.38	2.00	1.00	1-7/8
32-32 CBZ	32MSEL32N	3200-2-32	2	2	4.22	2.79	2.75	1.04	2-13/16

NOTE: C dimension is typical finger-tight.

Dimensions for reference only, subject to change.

Sizes 20, 24 require additional lubrication prior to assembly.

Color Coding

For easy reference, table column headings are color indicated as follows:

fractional



metric



**NPT Male
 Metric Elbow**
For metric tube

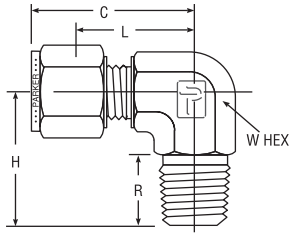
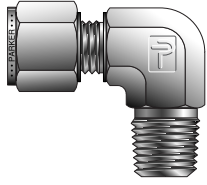

CPI™ PART NO.	A-LOK® PART NO.	INTER- CHANGES WITH	MILLIMETERS						INCHES
			TUBE O.D.	NPT THREAD	C	H	L	R	W HEX
CBZ 3-1/8	M3MSEL1/8N	3MO-2-2	3	1/8	23,6	17,8	17,0	9,7	7/16
CBZ 3-1/4	M3MSEL1/4N	3MO-2-4	3	1/4	24,6	23,4	18,0	14,2	1/2
CBZ 4-1/8	M4MSEL1/8N	4MO-2-2	4	1/8	25,4	18,8	19,2	9,7	1/2
CBZ 4-1/4	M4MSEL1/4N	4MO-2-4	4	1/4	26,2	25,4	19,6	14,2	1/2
CBZ 6-1/8	M6MSEL1/8N	6MO-2-2	6	1/8	27,0	18,8	19,6	9,7	1/2
CBZ 6-1/4	M6MSEL1/4N	6MO-2-4	6	1/4	27,0	23,4	19,6	14,2	1/2
CBZ 6-3/8	M6MSEL3/8N	6MO-2-6	6	3/8	29,8	26,2	22,4	14,2	11/16
CBZ 6-1/2	M6MSEL1/2N	6MO-2-8	6	1/2	31,8	33,0	24,4	19,0	13/16
CBZ 8-1/8	M8MSEL1/8N	8MO-2-2	8	1/8	28,8	19,8	21,3	9,7	9/16
CBZ 8-1/4	M8MSEL1/4N	8MO-2-4	8	1/4	28,8	24,4	21,3	14,2	9/16
CBZ 8-3/8	M8MSEL3/8N	8MO-2-6	8	3/8	30,6	26,2	23,1	14,2	11/16
CBZ 8-1/2	M8MSEL1/2N	8MO-2-8	8	1/2	32,7	33,0	25,2	19,1	13/16
CBZ 10-1/8	M10MSEL1/8N	10MO-2-8	10	1/8	31,5	21,6	23,9	9,7	11/16
CBZ 10-1/4	M10MSEL1/4N	10MO-2-4	10	1/4	31,5	26,2	23,9	14,2	11/16
CBZ 10-3/8	M10MSEL3/8N	10MO-2-6	10	3/8	31,5	26,2	23,9	14,2	11/16
CBZ 10-1/2	M10MSEL1/2N	10MO-2-8	10	1/2	33,5	33,0	25,9	19,0	13/16
CBZ 12-1/4	M12MSEL1/4N	12MO-2-4	12	1/4	36,0	28,2	25,9	14,2	13/16
CBZ 12-3/8	M12MSEL3/8N	12MO-2-6	12	3/8	36,0	28,2	25,9	14,2	13/16
CBZ 12-1/2	M12MSEL1/2N	12MO-2-8	12	1/2	36,0	33,0	25,9	19,0	13/16
CBZ 12-3/4	M12MSEL3/4N	12MO-2-12	12	3/4	39,8	36,8	29,7	19,0	1-1/16
CBZ 15-1/2	M15MSEL1/2N	15MO-2-8	15	1/2	38,0	35,1	27,9	19,0	15/16
CBZ 16-3/8	M16MSEL3/8N	16MO-2-6	16	3/8	38,0	30,2	27,9	14,2	15/16
CBZ 16-1/2	M16MSEL1/2N	16MO-2-8	16	1/2	38,0	35,1	27,9	19,0	15/16
CBZ 16-3/4	M16MSEL3/4N	16MO-2-12	16	3/4	39,8	36,8	29,7	19,0	1-1/16
CBZ 18-1/2	M18MSEL1/2N	18MO-2-8	18	1/2	39,8	36,8	29,7	19,0	1-1/16
CBZ 18-3/4	M18MSEL3/4N	18MO-2-12	18	3/4	39,8	36,8	29,7	19,0	1-1/16
CBZ 20-1/2	M20MSEL1/2N	20MO-2-8	20	1/2	44,6	41,7	34,5	19,0	1-3/8
CBZ 20-3/4	M20MSEL3/4N	20MO-2-12	20	3/4	44,6	41,7	34,5	19,0	1-3/8
CBZ 22-3/4	M22MSEL3/4N	22MO-2-12	22	3/4	44,6	41,7	34,5	19,0	1-3/8
CBZ 25-3/4	M25MSEL3/4N	25MO-2-12	25	3/4	49,1	41,7	36,8	19,0	1-3/8
CBZ 25-1	M25MSEL1N	25MO-2-16	25	1	49,1	46,5	36,8	23,9	1-3/8

NOTE: C dimension is typical finger-tight.

Dimensions for reference only, subject to change.

**BSP Taper
 Male Elbow**
For fractional tube

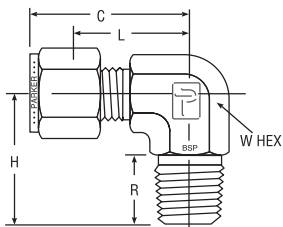
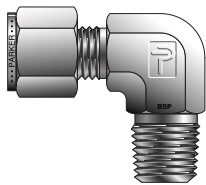

CPI™ PART NO.	A-LOK® PART NO.	INTER- CHANGES WITH	INCHES						
			TUBE O.D.	BSPT THREAD	C	H	L	R	W HEX
4-2K CBZ	4MSEL2K	400-2-2RT	1/4	1/8	1.06	0.75	0.77	.38	1/2
4-4K CBZ	4MSEL4K	400-2-4RT	1/4	1/4	1.06	0.94	0.77	.56	9/16
4-6K CBZ	4MSEL6K	400-2-6RT	1/4	3/8	1.17	1.05	0.88	.56	11/16
4-8K CBZ	4MSEL8K	400-2-8RT	1/4	1/2	1.25	1.32	0.96	.75	13/16
5-4K CBZ	5MSEL4K	500-2-4RT	5/16	1/4	1.13	0.98	0.84	.38	9/16
6-4K CBZ	6MSEL4K	600-2-4RT	3/8	1/4	1.20	1.02	0.91	.56	5/8
6-6K CBZ	6MSEL6K	600-2-4RT	3/8	3/8	1.23	1.05	0.97	.56	11/16
8-6K CBZ	8MSEL6K	810-2-6RT	1/2	3/8	1.42	1.13	1.02	.56	13/16
8-8K CBZ	8MSEL8K	810-2-8RT	1/2	1/2	1.42	1.32	1.02	.75	13/16

NOTE: C dimension is typical finger-tight.

Dimensions for reference only, subject to change.

BSP Taper Male Elbow
For metric tube

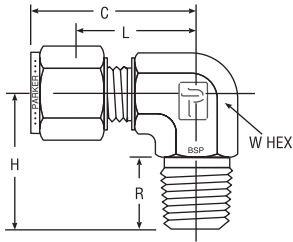
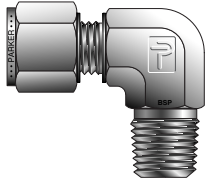

CPI™ PART NO.	A-LOK® PART NO.	INTER- CHANGES WITH	MILLIMETERS						INCHES	
			TUBE O.D.	BSPT THREAD	C	H	L	R	W HEX	
CBZ 3-1/8K	M3MSEL1/8K	3MO-2-2RT	3	1/8	23,6	17,8	17,0	9,7	7/16	
CBZ 3-1/4K	M3MSEL1/4K	3MO-2-4RT	3	1/4	24,6	23,4	18,0	14,2	1/2	
CBZ 4-1/8K	M4MSEL1/8K	4MO-2-2RT	4	1/8	25,4	18,8	18,8	9,7	1/2	
CBZ 4-1/4K	M4MSEL1/4K	4MO-2-4RT	4	1/4	24,6	23,4	18,8	14,2	1/2	
CBZ 6-1/8K	M6MSEL1/8K	6MO-2-2RT	6	1/8	27,0	18,8	19,6	9,7	1/2	
CBZ 6-1/4K	M6MSEL1/4K	6MO-2-4RT	6	1/4	27,0	23,4	19,6	14,2	1/2	
CBZ 6-3/8K	M6MSEL3/8K	6MO-2-6RT	6	3/8	29,8	26,2	22,4	14,2	11/16	
CBZ 6-1/2K	M6MSEL1/2K	6MO-2-8RT	6	1/2	31,8	33,0	24,4	19,0	13/16	
CBZ 8-1/8K	M8MSEL1/8K	8MO-2-2RT	8	1/8	28,8	19,8	21,3	9,7	9/16	
CBZ 8-1/4K	M8MSEL1/4K	8MO-2-4RT	8	1/4	28,8	24,4	21,3	14,2	9/16	
CBZ 8-3/8K	M8MSEL3/8K	8MO-2-6RT	8	3/8	30,6	26,2	23,1	14,2	11/16	
CBZ 8-1/2K	M8MSEL1/2K	8MO-2-8RT	8	1/2	32,7	33,0	25,2	19,1	13/16	
CBZ 10-1/8K	M10MSEL1/8K	10MO-2-2RT	10	1/8	31,5	21,6	23,9	9,7	11/16	
CBZ 10-1/4K	M10MSEL1/4K	10MO-2-4RT	10	1/4	31,5	26,2	23,9	14,2	11/16	
CBZ 10-3/8K	M10MSEL3/8K	10MO-2-6RT	10	3/8	31,5	26,2	23,9	14,2	11/16	
CBZ 10-1/2K	M10MSEL1/2K	10MO-2-8RT	10	1/2	33,5	33,0	25,9	19,0	13/16	
CBZ 12-1/4K	M12MSEL1/4K	12MO-2-4RT	12	1/4	36,0	28,2	25,9	14,2	13/16	
CBZ 12-3/8K	M12MSEL3/8K	12MO-2-6RT	12	3/8	36,0	28,2	25,9	14,2	13/16	
CBZ 12-1/2K	M12MSEL1/2K	12MO-2-8RT	12	1/2	36,0	33,0	25,9	19,0	13/16	
CBZ 12-3/4K	M12MSEL3/4K	12MO-2-12RT	12	3/4	39,8	36,8	29,7	19,1	1-1/16	
CBZ 16-3/8K	M16MSEL3/8K	16MO-2-6RT	16	3/8	38,0	30,2	27,9	14,2	15/16	
CBZ 16-1/2K	M16MSEL1/2K	16MO-2-8RT	16	1/2	38,0	35,1	27,9	19,0	15/16	
CBZ 18-1/2K	M18MSEL1/2K	18MO-2-8RT	18	1/2	39,8	36,8	29,7	19,0	1-1/16	
CBZ 18-3/4K	M18MSEL3/4K	18MO-2-12RT	18	3/4	39,8	36,8	29,7	19,0	1-1/16	
CBZ 20-3/4K	M20MSEL3/4K	20MO-2-12RT	20	3/4	44,6	41,7	34,5	19,0	1-3/8	
CBZ 25-3/4K	M25MSEL3/4K	25MO-2-12RT	25	3/4	49,0	41,7	36,8	19,1	1-3/8	
CBZ 25-1K	M25MSEL1K	25MO-2-16RT	25	1	49,1	46,5	36,8	23,9	1-3/8	

NOTE: C dimension is typical finger-tight.

Dimensions for reference only, subject to change.

Color Coding

For easy reference, table column headings are color indicated as follows:

fractional



metric



**NPT Male
45° Elbow**
For fractional tube

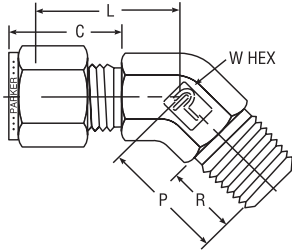
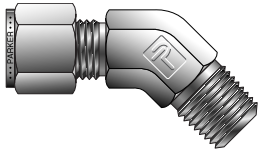

CPI™ PART NO.	A-LOK® PART NO.	INTER- CHANGES WITH	INCHES						
			TUBE O. D.	NPT PIPE THREAD	C	L	P	R	W HEX
1-1 VBZ	1MVEL1N	100-5-1	1/16	1/16	0.43	0.47	0.57	.38	7/16
2-2 VBZ	2MVEL2N	200-5-2	1/8	1/8	0.60	0.53	0.57	.38	7/16
3-2 VBZ	3MVEL2N	300-5-2	3/16	1/8	0.64	0.56	0.58	.38	7/16
4-2 VBZ	4MVEL2N	400-5-2	1/4	1/8	0.70	0.66	0.66	.38	9/16
4-4 VBZ	4MVEL4N	400-5-4	1/4	1/4	0.70	0.66	0.86	.56	9/16
5-2 VBZ	5MVEL2N	500-5-2	5/16	1/8	0.73	0.66	0.66	.38	9/16
6-2 VBZ	6MVEL2N	600-5-2	3/8	1/8	0.76	0.72	0.67	.38	9/16
6-4 VBZ	6MVEL4N	600-5-4	3/8	1/4	0.76	0.72	0.86	.56	9/16
6-6 VBZ	6MVEL6N	600-5-6	3/8	3/8	0.76	0.75	0.95	.56	3/4
8-6 VBZ	8MVEL6N	810-5-6	1/2	3/8	0.87	0.75	0.95	.56	3/4
10-8 VBZ	10MVEL8N	1010-5-8	5/8	1/2	0.87	0.84	1.20	.75	1-1/16
12-12 VBZ	12MVEL12N	1210-5-12	3/4	3/4	0.87	0.84	1.20	.75	1-1/16
14-12 VBZ	14MVEL12N	1410-5-12	7/8	3/4	0.87	1.36	1.27	.75	1-5/16
16-16 VBZ	16MVEL16N	1610-5-16	1	1	1.05	1.19	1.14	.94	1-5/16

NOTE: C dimension is typical finger-tight.

Dimensions for reference only, subject to change.

**NPT Male
45° Elbow**
For metric tube

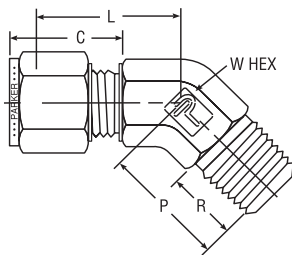
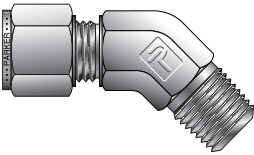

CPI™ PART NO.	A-LOK® PART NO.	INTER- CHANGES WITH	MILLIMETERS						
			TUBE O. D.	NPT PIPE THREAD	C	L	P	R	W HEX
VBZ 6-1/8	M6MVEL1/8N	—	6	1/8	17,7	16,0	16,8	9,5	14,0
VBZ 6-1/4	M6MVEL1/4N	—	6	1/4	17,7	16,0	21,8	14,3	14,0
VBZ 8-1/8	M8MVEL1/8N	—	8	1/8	18,6	16,8	16,8	9,5	14,0
VBZ 10-1/4	M10MVEL1/4N	—	10	1/4	19,5	19,0	24,1	14,3	19,0
VBZ 12-3/8	M12MVEL3/8N	—	12	3/8	22,0	19,0	24,1	14,3	19,0
VBZ 12-1/2	M12MVEL1/2N	—	12	1/2	22,0	20,6	29,7	19,0	22,0
VBZ 16-1/2	M16MVEL1/2N	—	16	1/2	22,0	20,6	29,7	19,0	22,0

NOTE: C dimension is typical finger-tight.

Dimensions for reference only, subject to change.

NPT Male Run Tee
For fractional tube

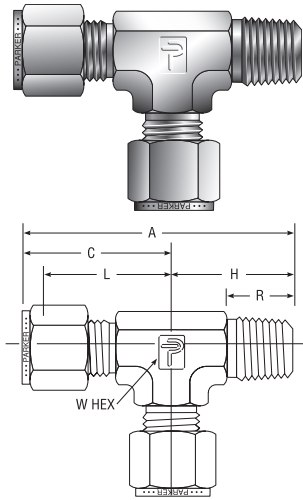

CPI™ PART NO.	A-LOK® PART NO.	INTER- CHANGES WITH	INCHES							
			TUBE O.D.	NPT PIPE THREAD	A	C	H	L	R	W HEX
2-2-2 RBZ	2MRT2N	200-3-2TMT	1/8	1/8	1.63	0.93	0.71	0.66	.38	7/16
2-4-2 RBZ	2MRT4N	200-3-4TMT	1/8	1/4	1.89	0.97	0.93	0.70	.56	9/16
3-2-3 RBZ	3MRT2N	300-3-2TMT	3/16	1/8	1.66	0.96	0.70	0.70	.38	7/16
4-2-4 RBZ	4MRT2N	400-3-2TMT	1/4	1/8	1.80	1.06	0.74	0.77	.38	1/2
4-4-4 RBZ	4MRT4N	400-3-4TMT	1/4	1/4	1.98	1.06	0.93	0.77	.56	1/2
5-2-5 RBZ	5MRT2N	500-3-2TMT	5/16	1/8	1.99	1.17	0.82	0.88	.38	5/8
5-4-5 RBZ	5MRT4N	500-3-4TMT	5/16	1/4	2.18	1.17	1.01	0.88	.56	5/8
6-4-6 RBZ	6MRT4N	600-3-4TMT	3/8	1/4	2.20	1.20	1.01	0.91	.56	5/8
6-6-6 RBZ	6MRT6N	600-3-6TMT	3/8	3/8	2.42	1.31	1.12	1.02	.56	13/16
8-6-8 RBZ	8MRT6N	810-3-6TMT	1/2	3/8	2.53	1.42	1.12	1.02	.56	13/16
8-8-8 RBZ	8MRT8N	810-3-8TMT	1/2	1/2	2.72	1.42	1.31	1.02	.75	7/8
10-8-10 RBZ	10MRT8N	1010-3-8TMT	5/8	1/2	2.88	1.50	1.39	1.10	.75	15/16
12-12-12 RBZ	12MRT12N	1210-3-12TMT	3/4	3/4	3.02	1.57	1.46	1.17	.75	1-1/16
14-12-14 RBZ	14MRT12N	1410-3-12TMT	7/8	3/4	3.41	1.76	1.65	1.36	.75	1-3/8
16-12-16 RBZ	16MRT12N	1610-3-12TMT	1	3/4	3.59	1.94	1.65	1.45	.75	1-3/8
16-16-16 RBZ	16MRT16N	1610-3-16TMT	1	1	3.78	1.94	1.84	1.45	.94	1-3/8

NOTE: A and C dimensions are typical finger-tight.

Dimensions for reference only, subject to change.

NPT Male Run Tee
For metric tube

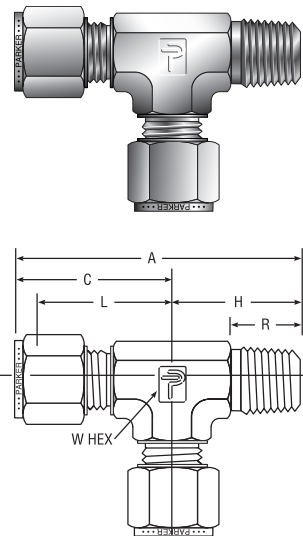

CPI™ PART NO.	A-LOK® PART NO.	INTER- CHANGES WITH	MILLIMETERS							INCHES
			TUBE O.D.	NPT THREAD	A	C	H	L	R	W HEX
RBZ 6-1/8-6	M6MRT1/8N	6MO-3-2TMT	6	1/8	45,8	27,0	18,0	19,6	9,7	1/2
RBZ 6-1/4-6	M6MRT1/4N	6MO-3-4TMT	6	1/4	50,3	27,0	23,4	19,6	14,2	1/2
RBZ 8-1/8-8	M8MRT1/8N	8MO-3-2TMT	8	1/8	50,7	29,9	20,8	22,4	9,7	5/8
RBZ 8-1/4-8	M8MRT1/4N	8MO-3-4TMT	8	1/4	55,3	29,9	25,4	22,4	14,2	5/8
RBZ 10-1/4-10	M10MRT1/4N	10MO-3-4TMT	10	1/4	61,7	33,5	28,2	25,9	14,2	13/16
RBZ 10-1/2-10	M10MRT1/2N	10MO-3-8TMT	10	1/2	66,5	33,5	33,0	25,9	19,0	13/16
RBZ 12-1/4-12	M12MRT1/4N	12MO-3-4TMT	12	1/4	64,2	36,0	28,2	25,9	14,2	13/16
RBZ 12-3/8-12	M12MRT3/8N	12MO-3-6TMT	12	3/8	64,2	36,0	28,2	25,9	14,2	13/16
RBZ 12-1/2-12	M12MRT1/2N	12MO-3-8TMT	12	1/2	69,0	36,0	33,0	25,9	19,0	13/16
RBZ 16-1-16	M16MRT1N	16MO-3-16TMT	16	1	93,1	46,6	46,5	34,4	23,9	1-3/8

NOTE: A and C dimensions are typical finger-tight.

Dimensions for reference only, subject to change.

Color Coding

For easy reference, table column headings are color indicated as follows:

fractional



metric



NPT Male Branch Tee
 For fractional tube

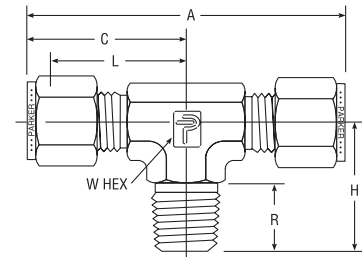
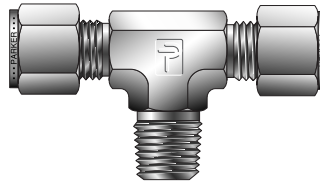

CPI™ PART NO.	A-LOK® PART NO.	INTER- CHANGES WITH	INCHES							
			TUBE O. D.	NPT PIPE THREAD	A	C	H	L	R	W HEX
2-2-2 SBZ	2MBT2N	200-3-2TTM	1/8	1/8	1.84	0.92	0.70	0.66	.38	7/16
2-2-4 SBZ	2MBT4N	200-3-4TTM	1/8	1/4	1.96	0.98	0.93	0.72	.56	1/2
3-3-2 SBZ	3MBT2N	300-3-2TTM	3/16	1/8	2.00	1.00	0.74	0.74	.38	1/2
4-4-2 SBZ	4MBT2N	400-3-2TTM	1/4	1/8	2.12	1.06	0.74	0.77	.38	1/2
4-4-4 SBZ	4MBT4N	400-3-4TTM	1/4	1/4	2.12	1.07	0.93	0.77	.56	1/2
5-5-2 SBZ	5MBT2N	500-3-2TTM	5/16	1/8	2.34	1.17	0.82	0.88	.38	5/8
5-5-4 SBZ	5MBT4N	500-3-4TTM	5/16	1/4	2.34	1.17	1.01	0.88	.56	5/8
6-6-4 SBZ	6MBT4N	600-3-4TTM	3/8	1/4	2.40	1.20	1.01	0.91	.56	5/8
6-6-6 SBZ	6MBT6N	600-3-6TTM	3/8	3/8	2.62	1.31	1.12	1.02	.56	13/16
8-8-6 SBZ	8MBT6N	810-3-6TTM	1/2	3/8	2.84	1.42	1.12	1.02	.56	13/16
8-8-8 SBZ	8MBT8N	810-3-8TTM	1/2	1/2	2.86	1.43	1.31	1.03	.75	7/8
10-10-8 SBZ	10MBT8N	1010-3-8TTM	5/8	1/2	2.86	1.53	1.42	1.13	.75	1
12-12-12 SBZ	12MBT12N	1210-3-12TTM	3/4	3/4	3.14	1.57	1.46	1.17	.75	1-1/16
14-14-12 SBZ	14MBT12N	1410-3-12TTM	7/8	3/4	3.52	1.76	1.65	1.36	.75	1-3/8
16-16-12 SBZ	16MBT12N	1610-3-12TTM	1	3/4	3.88	1.94	1.65	1.45	.75	1-3/8
16-16-16 SBZ	16MBT16N	1610-3-16TTM	1	1	3.88	1.94	1.84	1.45	.94	1-3/8

NOTE: A and C dimensions are typical finger-tight.

Dimensions for reference only, subject to change.

NPT Male Branch Tee
 For metric tube

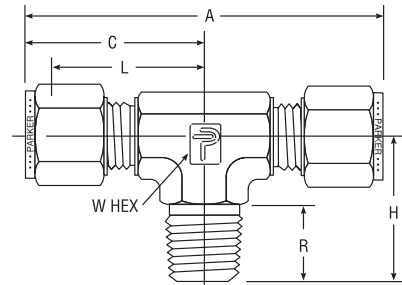
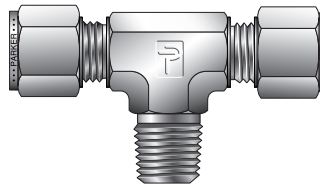

CPI™ PART NO.	A-LOK® PART NO.	INTER- CHANGES WITH	MILLIMETERS								INCHES W HEX
			TUBE O. D.	NPT THREAD	A	C	H	L	R		
SBZ 6-6-1/8	M6MBT1/8N	6MO-3TTM	6	1/8	53,9	27,0	18,8	19,6	9,7	1/2	
SBZ 6-6-1/4	M6MBT1/4N	6MO-3-4TTM	6	1/4	53,9	27,0	23,4	19,6	14,2	1/2	
SBZ 8-8-1/8	M8MBT1/8N	6MO-3-2TTM	8	1/8	59,7	29,9	20,8	22,4	9,7	5/8	
SBZ 8-8-1/4	M8MBT1/4N	8MO-3-4TTM	8	1/4	59,7	29,9	25,4	22,4	14,2	5/8	
SBZ 10-10-1/4	M10MBT1/4N	10MO-3-4TTM	10	1/4	67,0	33,5	28,2	25,9	14,2	13/16	
SBZ 10-10-3/8	M10MBT3/8N	10MO-3-6TTM	10	3/8	67,0	33,5	28,2	25,9	14,2	13/16	
SBZ 12-12-1/4	M12MBT1/4N	12MO-3-4TTM	12	1/4	72,0	36,0	28,2	25,9	14,2	13/16	
SBZ 12-12-3/8	M12MBT3/8N	12MO-3-6TTM	12	3/8	72,0	36,0	28,2	25,9	14,2	13/16	
SBZ 12-12-1/2	M12MBT1/2N	12MO-3-8TTM	12	1/2	72,0	36,0	33,0	25,9	19,0	13/16	
SBZ 16-16-1/2	M16MBT1/2N	16MO-3-8TTM	16	1/2	77,6	38,8	35,8	28,7	19,1	1	

NOTE: A and C dimensions are typical finger-tight.

Dimensions for reference only, subject to change.

NPT Female Connector
For fractional tube

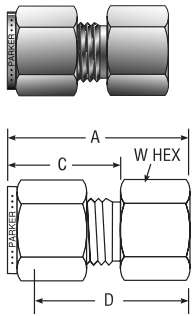

CPI™ PART NO.	A-LOK® PART NO.	INTER- CHANGES WITH	INCHES					
			TUBE O. D.	NPT PIPE THREAD	A	C	D	W HEX
1-1 GBZ	1FSC1N	100-7-1	1/16	1/16	0.93	0.43	0.78	7/16
1-2 GBZ	1FSC2N	100-7-2	1/16	1/8	0.95	0.43	0.81	9/16
2-2 GBZ	2FSC2N	200-7-2	1/8	1/8	1.14	0.60	0.88	9/16
2-4 GBZ	2FSC4N	200-7-4	1/8	1/4	1.32	0.60	1.06	3/4
3-2 GBZ	3FSC2N	300-7-2	3/16	1/8	1.17	0.64	0.91	9/16
3-4 GBZ	3FSC4N	300-7-4	3/16	1/4	1.35	0.64	1.09	3/4
4-2 GBZ	4FSC2N	400-7-2	1/4	1/8	1.23	0.70	0.94	9/16
4-4 GBZ	4FSC4N	400-7-4	1/4	1/4	1.42	0.70	1.13	3/4
4-6 GBZ	4FSC6N	400-7-6	1/4	3/8	1.48	0.70	1.19	7/8
4-8 GBZ	4FSC8N	400-7-8	1/4	1/2	1.67	0.70	1.38	1-1/16
5-2 GBZ	5FSC2N	500-7-2	5/16	1/8	1.27	0.73	0.97	9/16
5-4 GBZ	5FSC4N	500-7-4	5/16	1/4	1.46	0.73	1.16	3/4
5-6 GBZ	5FSC6N	500-7-6	5/16	3/8	1.51	0.73	1.22	7/8
6-2 GBZ	6FSC2N	600-7-2	3/8	1/8	1.29	0.76	1.00	5/8
6-4 GBZ	6FSC4N	600-7-4	3/8	1/4	1.48	0.76	1.19	3/4
6-6 GBZ	6FSC6N	600-7-6	3/8	3/8	1.54	0.76	1.25	7/8
6-8 GBZ	6FSC8N	600-7-8	3/8	1/2	1.73	0.76	1.44	1-1/16
6-12 GBZ	6FSC12N	600-7-12	3/8	3/4	1.85	0.76	1.56	1-1/4
8-4 GBZ	8FSC4N	810-7-4	1/2	1/4	1.59	0.87	1.19	13/16
8-6 GBZ	8FSC6N	810-7-6	1/2	3/8	1.65	0.87	1.25	7/8
8-8 GBZ	8FSC8N	810-7-8	1/2	1/2	1.84	0.87	1.44	1-1/16
8-12 GBZ	8FSC12N	810-7-12	1/2	3/4	1.96	0.87	1.56	1-1/4
10-6 GBZ	10FSC6N	1010-7-6	5/8	3/8	1.65	0.87	1.25	15/16
10-8 GBZ	10FSC8N	1010-7-8	5/8	1/2	1.84	0.87	1.44	1-1/16
10-12 GBZ	10FSC12N	1010-7-12	5/8	3/4	1.96	0.87	1.56	1-3/8
12-8 GBZ	12FSC8N	1210-7-8	3/4	1/2	1.84	0.87	1.44	1-1/16
12-12 GBZ	12FSC12N	1210-7-12	3/4	3/4	1.96	0.87	1.56	1-3/8
14-12 GBZ	14FSC12N	1410-7-12	7/8	3/4	1.96	0.87	1.56	1-3/8
16-12 GBZ	16FSC12N	1610-7-12	1	3/4	2.15	1.05	1.66	1-3/8
16-16 GBZ	16FSC16N	1610-7-16	1	1	2.46	1.05	1.97	1-5/8
20-20 GBZ	20FSC20N	2010-7-20	1-1/4	1-1/4	2.94	1.52	2.08	2
24-24 GBZ	24FSC24N	2410-7-24	1-1/2	1-1/2	3.28	1.77	2.22	2-3/8
32-32 GBZ	32FSC32N	3210-7-32	2	2	4.00	2.47	2.53	2-7/8

NOTE: A and C dimensions are typical finger-tight.

Dimensions for reference only, subject to change.

Sizes 20, 24, 32 require additional lubrication prior to assembly.

NPT Female Connector
For metric tube

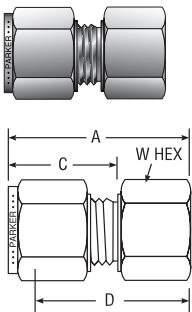

CPI™ PART NO.	A-LOK® PART NO.	INTER- CHANGES WITH	MILLIMETERS					
			TUBE O. D.	NPT THREAD	A	C	D	W HEX
GBZ 3-1/8	M3FSC1/8N	3MO-7-2	3	1/8	28,8	15,3	22,2	14,0
GBZ 3-1/4	M3FSC1/4N	3MO-7-4	3	1/4	33,6	15,3	27,0	19,0
GBZ 4-1/8	M4FSC1/8N	4MO-7-2	4	1/8	29,6	16,1	23,0	14,0
GBZ 6-1/8	M6FSC1/8N	6MO-7-2	6	1/8	31,3	17,7	23,8	14,0
GBZ 6-1/4	M6FSC1/4N	6MO-7-4	6	1/4	36,1	17,7	28,6	19,0
GBZ 6-3/8	M6FSC3/8N	6MO-7-6	6	3/8	37,7	17,7	30,2	22,0
GBZ 6-1/2	M6FSC1/2N	6MO-7-8	6	1/2	42,5	17,7	35,0	27,0
GBZ 8-1/8	M8FSC1/8N	8MO-7-2	8	1/8	32,1	18,6	24,6	14,0
GBZ 8-1/4	M8FSC1/4N	8MO-7-4	8	1/4	36,9	18,6	29,4	19,0
GBZ 8-3/8	M8FSC3/8N	8MO-7-6	8	3/8	38,5	18,6	31,0	22,0
GBZ 10-1/4	M10FSC1/4N	10MO-7-4	10	1/4	37,8	19,5	30,2	19,0
GBZ 10-3/8	M10FSC3/8N	10MO-7-6	10	3/8	39,4	19,5	31,8	22,0
GBZ 10-1/2	M10FSC1/2N	10MO-7-8	10	1/2	44,1	19,5	36,5	27,0
GBZ 12-1/4	M12FSC1/4N	12MO-7-4	12	1/4	41,9	22,0	31,8	22,0
GBZ 12-3/8	M12FSC3/8N	12MO-7-6	12	3/8	41,9	22,0	31,8	22,0
GBZ 12-1/2	M12FSC1/2N	12MO-7-8	12	1/2	46,6	22,0	36,5	27,0
GBZ 16-3/8	M16FSC3/8N	16MO-7-6	16	3/8	41,9	22,0	31,8	27,0
GBZ 16-1/2	M16FSC1/2N	16MO-7-8	16	1/2	46,9	22,0	36,5	27,0
GBZ 20-1/2	M20FSC1/2N	20MO-7-8	20	1/2	47,9	22,0	37,8	30,0
GBZ 20-3/4	M20FSC3/4N	20MO-7-12	20	3/4	49,7	22,0	39,6	35,0
GBZ 22-3/4	M22FSC3/4N	22MO-7-12	22	3/4	49,7	22,0	39,6	35,0
GBC 25-3/4	M25FSC3/4N	25MO-7-12	25	3/4	53,6	26,5	41,3	35,0
GBC 25-1	M25FSC1N	25MO-7-16	25	1	62,3	26,5	50,0	41,0

Dimensions for reference only, subject to change.

BSP Taper Female Connector For fractional tube

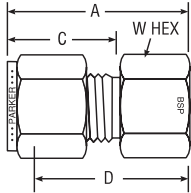
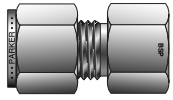

CPI™ PART NO.	A-LOK® PART NO.	INTER- CHANGES WITH	INCHES						
			TUBE O. D.	BSPT THREAD	A	C	D	W HEX	BORE
4-2K GBZ	4FSC2K	400-7-2RT	1/4	1/8	1.24	.70	0.94	9/16	.19
4-4K GBZ	4FSC4K	400-7-4RT	1/4	1/4	1.42	.70	1.13	3/4	.19
4-6K GBZ	4FSC6K	400-7-6RT	1/4	3/8	1.49	.70	1.19	7/8	.19
4-8K GBZ	4FSC8K	400-7-8RT	1/4	1/2	1.68	.70	1.38	1-1/16	.19
6-4K GBZ	6FSC4K	600-7-4RT	3/8	1/4	1.48	.76	1.19	3/4	.28
6-6K GBZ	6FSC6K	600-7-6RT	3/8	3/8	1.54	.76	1.25	7/8	.28
6-8K GBZ	6FSC8K	600-7-8RT	3/8	1/2	1.73	.76	1.44	1-1/16	.28
8-4K GBZ	8FSC4K	810-7-4RT	1/2	1/4	1.59	.87	1.19	13/16	.406
8-6K GBZ	8FSC6K	810-7-6RT	1/2	3/8	1.65	.87	1.25	7/8	.406
8-8K GBZ	8FSC8K	810-7-8RT	1/2	1/2	1.84	.87	1.44	1-1/16	.406

Dimensions for reference only, subject to change.

BSP Taper Female Connector For metric tube

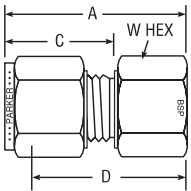
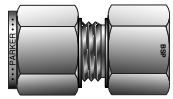

CPI™ PART NO.	A-LOK® PART NO.	INTER- CHANGES WITH	MILLIMETERS					
			TUBE O. D.	BSPT THREAD	A	C	D	W HEX
GBZ 3-1/8K	M3FSC1/8K	3MO-7-2RT	3	1/8	29,2	15,3	22,6	14,0
GBZ 6-1/8K	M6FSC1/8K	6MO-7-2RT	6	1/8	31,3	17,7	23,8	14,0
GBZ 6-1/4K	M6FSC1/4K	6MO-7-4RT	6	1/4	35,8	17,7	28,3	19,0
GBZ 6-3/8K	M6FSC3/8K	6MO-7-6RT	6	3/8	37,6	17,7	30,1	22,0
GBZ 6-1/2K	M6FSC1/2K	6MO-7-8RT	6	1/2	42,5	17,7	35,0	27,0
GBZ 8-1/8K	M8FSC1/8K	8MO-7-2RT	8	1/8	32,8	18,6	25,3	15,0
GBZ 8-1/4K	M8FSC1/4K	8MO-7-4RT	8	1/4	37,0	18,6	29,5	19,0
GBZ 8-3/8K	M8FSC3/8K	8MO-7-6RT	8	3/8	38,5	18,6	31,0	22,0
GBZ 8-1/2K	M8FSC1/2K	8MO-7-8RT	8	1/2	43,3	18,6	35,8	27,0
GBZ 10-1/8K	M10FSC1/8K	10MO-7-2RT	10	1/8	33,0	19,5	25,4	18,0
GBZ 10-1/4K	M10FSC1/4K	10MO-7-4RT	10	1/4	37,8	19,5	30,2	19,0
GBZ 10-3/8K	M10FSC3/8K	10MO-7-6RT	10	3/8	39,4	19,5	31,8	22,0
GBZ 10-1/2K	M10FSC1/2K	10MO-7-8RT	10	1/2	44,2	19,5	36,6	27,0
GBZ 12-1/4K	M12FSC1/4K	12MO-7-4RT	12	1/4	40,3	22,0	30,2	22,0
GBZ 12-3/8K	M12FSC3/8K	12MO-7-6RT	12	3/8	41,9	22,0	31,8	22,0
GBZ 12-1/2K	M12FSC1/2K	12MO-7-8RT	12	1/2	46,7	22,0	36,6	27,0
GBZ 16-1/2K	M16FSC1/2K	16MO-7-8RT	16	1/2	48,4	22,0	38,3	18,0
GBZ 20-1/2K	M20FSC1/2K	20MO-7-8RT	20	1/2	54,7	22,0	44,6	30,0
GBZ 20-3/4K	M20FSC3/4K	20MO-7-12RT	20	3/4	49,7	22,0	39,6	35,0
GBZ 22-1K	M22FSC1K	22MO-7-16RT	22	1	57,9	22,0	47,8	41,0
GBZ 25-3/4K	M25FSC3/4K	25MO-7-12RT	25	3/4	54,3	26,5	42,1	35,0
GBZ 25-1K	M25FSC1K	25MO-7-16RT	25	1	61,5	26,5	49,3	41,0

NOTE: A and C dimensions are typical finger-tight.

Dimensions for reference only, subject to change.

Color Coding

For easy reference, table column headings are color indicated as follows:

fractional



metric



NPT Female Bulkhead Connector For fractional tube

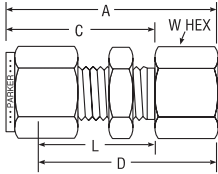
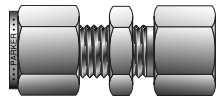

CPI™ PART NO.	A-LOK® PART NO.	INTER- CHANGES WITH	INCHES						
			TUBE O.D.	NPT PIPE THREAD	A	C	D	L	W HEX
2-2 GH2BZ	2FBC2N	200-71-2	1/8	1/8	1.76	1.23	1.50	0.97	9/16
3-2 GH2BZ	3FBC2N	300-71-2	3/16	1/8	1.79	1.26	1.53	1.00	9/16
4-2 GH2BZ	4FBC2N	400-71-2	1/4	1/8	1.85	1.31	1.56	1.02	5/8
4-4 GH2BZ	4FBC4N	400-71-4	1/4	1/4	2.04	1.31	1.75	1.02	3/4
5-2 GH2BZ	5FBC2N	500-71-2	5/16	1/8	1.96	1.42	1.66	1.12	11/16
5-8 GH2BZ	5FBC8N	500-71-8	5/16	1/2	2.38	1.42	2.08	1.12	1-1/16
6-4 GH2BZ	6FBC4N	600-71-4	3/8	1/4	2.17	1.44	1.88	1.15	3/4
8-6 GH2BZ	8FBC6N	810-71-6	1/2	3/8	2.43	1.65	2.03	1.25	15/16
8-8 GH2BZ	8FBC8N	810-71-8	1/2	1/2	2.62	1.65	2.22	1.25	1-1/16
10-8 GH2BZ	10FBC8N	1010-71-8	5/8	1/2	2.65	1.68	2.25	1.28	1-1/16
12-12 GH2BZ	12FBC12N	1210-71-12	3/4	3/4	2.90	1.87	2.50	1.47	1-3/8
14-12 GH2BZ	14FBC12N	1410-71-12	7/8	3/4	3.18	2.09	2.78	1.69	1-3/8
16-16 GH2BZ	16FBC16N	1610-71-16	1	1	3.68	2.27	3.19	1.78	1-5/8

NOTE: A and C dimensions are typical finger-tight.

Dimensions for reference only, subject to change.

For bulkhead hole drill size and maximum bulkhead thickness, [see page 32, Part BC](#).

NPT Female Bulkhead Connector For metric tube

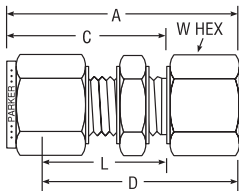
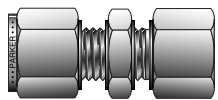

CPI™ PART NO.	A-LOK® PART NO.	INTER- CHANGES WITH	MILLIMETERS								B'HEAD HOLE DRILL SIZE	MAX. B'HEAD THICK.
			TUBE O.D.	NPT THREAD	A	C	D	L	W HEX			
GH2BZ 6-1/8	M6FBC1/8N	6MO-71-2	6	1/8	47,2	33,7	39,7	26,2	16,0	11,5	10,2	
GH2BZ 6-1/4	M6FBC1/4N	6MO-71-4	6	1/4	52,0	33,7	44,5	26,2	19,0	11,5	10,2	
GH2BZ 8-1/8	M8FBC1/8N	8MO-71-2	8	1/8	49,6	36,1	42,1	28,5	18,0	13,1	11,2	
GH2BZ 10-1/4	M10FBC1/4N	10MO-71-4	10	1/4	55,2	37,0	47,6	29,4	19,0	16,3	11,2	
GH2BZ 12-3/8	M12FBC3/8N	12MO-71-6	12	3/8	60,9	41,9	50,8	31,8	24,0	19,5	12,7	
GH2BZ 12-1/2	M12FBC1/2N	12MO-71-8	12	1/2	66,4	41,9	56,3	31,8	27,0	19,5	12,7	

NOTE: A and C dimensions are typical finger-tight.

Dimensions for reference only, subject to change.

For bulkhead hole drill size and maximum bulkhead thickness, [see page 32, Part BC](#).

BSPP Gauge Connector For fractional tube

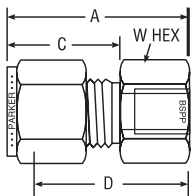
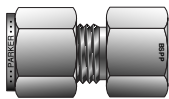

CPI™ PART NO.	A-LOK® PART NO.	INTER- CHANGES WITH	INCHES						
			TUBE O.D.	BSPP THREAD	A	C	D	W HEX	BORE
4-4GC GBZ	4FSC4GC	400-7-4RG	1/4	1/4	1.48	.70	1.19	3/4	.19
4-6GC GBZ	4FSC6GC	400-7-6RG	1/4	3/8	1.48	.70	1.19	7/8	.19
4-8GC GBZ	4FSC8GC	400-7-8RG	1/4	1/2	1.70	.70	1.41	1-1/16	.19
5-4GC GBZ	5FSC4GC	500-7-4RG	5/16	1/4	1.51	.73	1.22	3/4	.21
5-8GC GBZ	5FSC8GC	500-7-8RG	5/16	1/2	1.59	.73	1.30	1-1/16	.28
6-4GC GBZ	6FSC4GC	600-7-4RG	3/8	1/4	1.55	.76	1.25	3/4	.21
6-6GC GBZ	6FSC6GC	600-7-6RG	3/8	3/8	1.55	.76	1.25	7/8	.26
6-8GC GBZ	6FSC8GC	600-7-8RG	3/8	1/2	1.63	.76	1.33	1-1/16	.28
8-4GC GBZ	8FSC4GC	810-7-4RG	1/2	1/4	1.65	.86	1.25	13/16	.21
8-6GC GBZ	8FSC6GC	810-7-6RG	1/2	3/8	1.75	.86	1.35	7/8	.26
8-8GC GBZ	8FSC8GC	810-7-8RG	1/2	1/2	1.90	.86	1.50	1-1/16	.28

NOTE: A and C dimensions are typical finger-tight.

Dimensions for reference only, subject to change.

See catalog 4260 Pipe/ISO Fittings for detailed information.
 Sealing Washer on page 76 to be used with this fitting.

BSPP Gauge Connector For metric tube

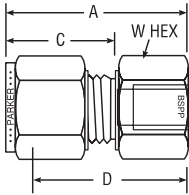
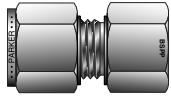

CPI™ PART NO.	A-LOK® PART NO.	INTER- CHANGES WITH	INCHES					
			TUBE O.D.	BSPP THREAD	A	C	D	W HEX
GBZ 3-1/4GC	M3GC1/4R	3MO-7-4RG	3	1/4	35,3	15,3	28,7	19,0
GBZ 6-1/4GC	M6GC1/4R	6MO-7-4RG	6	1/4	37,7	17,7	30,2	19,0
GBZ 6-3/8GC	M6GC3/8R	6MO-7-6RG	6	3/8	37,7	17,7	30,2	22,0
GBZ 6-1/2GC	M6GC1/2R	6MO-7-8RG	6	1/2	43,2	17,7	35,7	27,0
GBZ 8-1/4GC	M8GC1/4R	8MO-7-4RG	8	1/4	38,5	18,6	31,0	19,0
GBZ 8-3/8GC	M8GC3/8R	8MO-7-6RG	8	3/8	40,8	18,6	33,3	22,0
GBZ 8-1/2GC	M8GC1/2R	8MO-7-8RG	8	1/2	44,0	18,6	36,5	27,0
GBZ 10-1/4GC	M10GC1/4R	10MO-7-4RG	10	1/4	39,4	19,5	31,8	19,0
GBZ 10-3/8GC	M10GC3/8R	10MO-7-6RG	10	3/8	38,8	19,5	31,2	22,0
GBC 10-1/2GC	M10GC1/2R	10MO-7-8RG	10	1/2	41,3	19,5	33,7	27,0
GBC 12-1/4GC	M12GC1/4R	12MO-7-4RG	12	1/4	41,9	22,0	31,8	22,0
GBC 12-3/8GC	M12GC3/8R	12MO-7-6RG	12	3/8	44,4	22,0	34,3	22,0
GBC 12-1/2GC	M12GC1/2R	12MO-7-8RG	12	1/2	48,2	22,0	38,1	27,0

NOTE: A and C dimensions are typical finger-tight.

Dimensions for reference only, subject to change.

See Catalog 4260 Pipe/ISO Fittings for detailed information.
 Sealing Washer on page 76 to be used with this fitting.

NPT Female Elbow For fractional tube

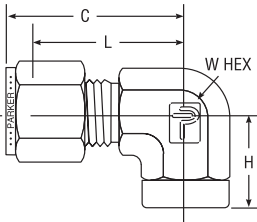
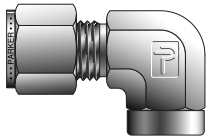

CPI™ PART NO.	A-LOK® PART NO.	INTER- CHANGES WITH	INCHES					
			TUBE O.D.	NPT PIPE THREAD	C	H	L	W HEX
1-1 DBZ	1FEL1N	100-8-1	1/16	1/16	0.75	0.50	0.60	7/16
1-2 DBZ	1FEL2N	100-8-2	1/16	1/8	0.79	0.75	0.64	9/16
2-2 DBZ	2FEL2N	200-8-2	1/8	1/8	0.97	0.75	0.71	9/16
2-4 DBZ	2FEL4N	200-8-4	1/8	1/4	1.10	0.88	0.84	3/4
3-2 DBZ	3FEL2N	300-8-2	3/16	1/8	1.00	0.75	0.74	9/16
4-2 DBZ	4FEL2N	400-8-2	1/4	1/8	1.06	0.75	0.77	9/16
4-4 DBZ	4FEL4N	400-8-4	1/4	1/4	1.20	0.88	0.91	11/16
4-6 DBZ	4FEL6N	400-8-6	1/4	3/8	1.25	0.88	0.96	13/16
4-8 DBZ	4FEL8N	400-8-8	1/4	1/2	1.36	1.13	1.07	1
5-2 DBZ	5FEL2N	500-8-2	5/16	1/8	1.13	0.75	0.84	9/16
5-4 DBZ	5FEL4N	500-8-4	5/16	1/4	1.24	0.88	0.94	11/16
6-2 DBZ	6FEL2N	600-8-2	3/8	1/8	1.20	0.75	0.91	5/8
6-4 DBZ	6FEL4N	600-8-4	3/8	1/4	1.26	0.88	0.97	11/16
6-6 DBZ	6FEL6N	600-8-6	3/8	3/8	1.31	0.88	1.02	13/16
6-8 DBZ	6FEL8N	600-8-8	3/8	1/2	1.42	1.13	1.13	1
8-4 DBZ	8FEL4N	810-8-4	1/2	1/4	1.42	0.88	1.02	13/16
8-6 DBZ	8FEL6N	810-8-6	1/2	3/8	1.42	0.88	1.02	13/16
8-8 DBZ	8FEL8N	810-8-8	1/2	1/2	1.53	1.13	1.13	1
10-6 DBZ	10FEL6N	1010-8-6	5/8	3/8	1.50	0.88	1.10	15/16
10-8 DBZ	10FEL8N	1010-8-8	5/8	1/2	1.57	1.13	1.17	1-1/16
12-8 DBZ	12FEL8N	1210-8-8	3/4	1/2	1.57	1.13	1.17	1-1/16
12-12 DBZ	12FEL12N	1210-8-12	3/4	3/4	1.76	1.25	1.36	1-3/8
14-12 DBZ	14FEL12N	1410-8-12	7/8	3/4	1.76	1.25	1.36	1-3/8
16-12 DBZ	16FEL12N	1610-8-12	1	3/4	1.93	1.25	1.45	1-3/8
16-16 DBZ	16FEL16N	1610-8-16	1	1	2.02	1.50	1.53	1-5/8

NOTE: C dimension is typical finger-tight.

Dimensions for reference only, subject to change.

NPT Female Elbow For metric tube

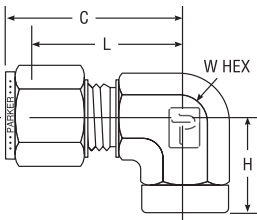

CPI™ PART NO.	A-LOK® PART NO.	INTER- CHANGES WITH	MILLIMETERS				INCHES	
			TUBE O.D.	NPT THREAD	C	H	L	W HEX
DBZ 6-1/8	M6FEL1/8N	6MO-8-2	6	1/8	27,0	19,0	19,6	1/2
DBZ 6-1/4	M6FEL1/4N	6MO-8-4	6	1/4	29,8	22,4	22,4	11/16
DBZ 8-1/8	M8FEL1/8N	8MO-8-2	8	1/8	28,8	19,1	21,3	9/16
DBZ 8-1/4	M8FEL1/4N	8MO-8-4	8	1/4	30,6	22,4	23,1	11/16
DBZ 10-1/4	M10FEL1/4N	10MO-8-4	10	1/4	33,5	22,4	25,9	13/16
DBZ 10-3/8	M10FEL3/8N	10MO-8-6	10	3/8	33,5	22,4	25,9	13/16
DBZ 10-1/2	M10FEL1/2N	10MO-8-8	10	1/2	36,3	28,5	28,7	1
DBZ 12-1/4	M12FEL1/4N	12MO-8-4	12	1/4	36,0	22,4	25,9	13/16
DBZ 12-3/8	M12FEL3/8N	12MO-8-6	12	3/8	36,0	22,4	25,9	13/16
DBZ 12-1/2	M12FEL1/2N	12MO-8-8	12	1/2	38,8	28,4	28,7	1
DBZ 16-3/8	M16FEL3/8N	16MO-8-6	16	3/8	39,5	23,6	29,7	1-1/16
DBZ 16-1/2	M16FEL1/2N	16MO-8-8	16	1/2	39,5	28,4	29,7	1-1/16

NOTE: C dimension is typical finger-tight.

Dimensions for reference only, subject to change.



NPT Female Run Tee
For fractional tube

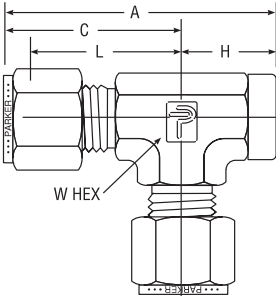
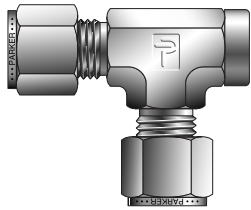

CPI™ PART NO.	A-LOK® PART NO.	INTER- CHANGES WITH	INCHES						
			TUBE O.D.	NPT PIPE THREAD	A	C	H	L	W HEX
2-2-2 MBZ	2FRT2N	200-3-2TFT	1/8	1/8	1.72	0.96	0.75	0.70	1/2
3-2-3 MBZ	3FRT2N	300-3-2TFT	3/16	1/8	1.76	1.01	0.75	0.74	1/2
4-2-4 MBZ	4FRT2N	400-3-2TFT	1/4	1/8	1.81	1.06	0.75	0.77	1/2
4-4-4 MBZ	4FRT4N	400-3-4TFT	1/4	1/4	2.05	1.17	0.88	0.88	11/16
5-2-5 MBZ	5FRT2N	500-3-2TFT	5/16	1/8	1.92	1.17	0.75	0.88	5/8
6-4-6 MBZ	6FRT4N	600-3-4TFT	3/8	1/4	2.11	1.23	0.88	0.94	11/16
8-4-8 MBZ	8FRT4N	810-3-4TFT	1/2	1/4	2.56	1.42	0.88	1.02	13/16
8-6-8 MBZ	8FRT6N	810-3-6TFT	1/2	3/8	2.30	1.42	0.88	1.02	7/8
8-8-8 MBZ	8FRT8N	810-3-8TFT	1/2	1/2	2.66	1.53	1.13	1.13	1
10-8-10 MBZ	10FRT8N	1010-3-8TFT	5/8	1/2	2.70	1.57	1.13	1.17	1-1/16
12-12-12 MBZ	12FRT12N	1210-3-12TFT	3/4	3/4	3.01	1.76	1.25	1.36	1-3/8
14-8-14 MBZ	14FRT8N	1410-3-8TFT	7/8	1/2	3.01	1.76	1.25	1.36	1-3/8
14-12-14 MBZ	14FRT12N	1410-3-12TFT	7/8	3/4	3.01	1.76	1.25	1.36	1-3/8
16-12-16 MBZ	16FRT12N	1610-3-12TFT	1	3/4	3.18	1.93	1.25	1.45	1-3/8
16-16-16 MBZ	16FRT16N	1610-3-16TFT	1	1	3.52	2.02	1.50	1.65	1-5/8

NOTE: A and C dimensions are typical finger-tight.

Dimensions for reference only, subject to change.

NPT Female Run Tee
For metric tube

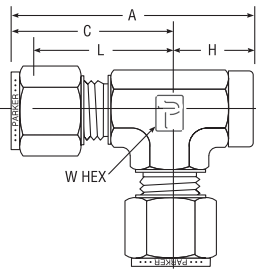
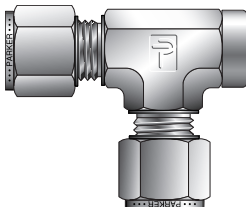

CPI™ PART NO.	A-LOK® PART NO.	INTER- CHANGES WITH	MILLIMETERS						INCHES
			TUBE O.D.	NPT THREAD	A	C	H	L	W HEX
MBZ 6-1/8-6	M6FRT1/8N	6MO-3TFT	6	1/8	46,0	27,0	19,0	19,6	1/2
MBZ 6-1/4-6	M6FRT1/4N	6MO-3-4TFT	6	1/4	52,1	29,8	22,4	22,4	11/16
MBZ 6-1/8-6	M8FRT1/8N	8MO-3TFT	8	1/8	48,9	29,9	19,0	22,4	5/8
MBZ 10-1/4-10	M10FRT1/4N	10MO-3TFT	10	1/4	55,9	33,5	22,4	25,9	13/16
MBZ 12-1/4-12	M12FRT1/4N	12MO-3-4TFT	12	1/4	58,4	36,0	22,4	25,9	13/16
MBZ 12-3/8-12	M12FRT3/8N	12MO-3TFT	12	3/8	58,4	36,0	22,4	25,9	13/16
MBZ 12-1/2-12	M12FRT1/2N	12MO-3-8TFT	12	1/2	67,3	38,8	28,5	28,7	1
MBZ 16-1/2-16	M16FRT1/2N	16MO-3TTF	16	1/2	68,2	39,8	28,4	29,7	1-1/16

NOTE: A and C dimensions are typical finger-tight.

Dimensions for reference only, subject to change.

Color Coding

For easy reference, table column headings are color indicated as follows:

fractional



metric



Tube to Female Pipe

NPT Female Branch Tee For fractional tube

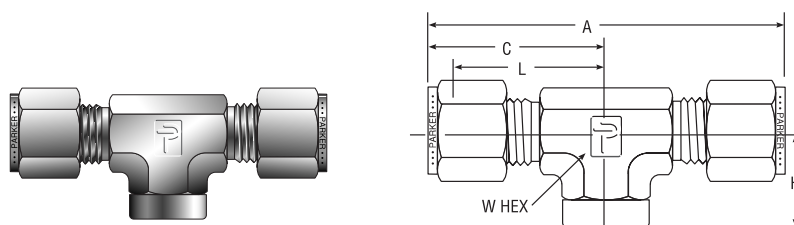

CPI™ PART NO.	A-LOK® PART NO.	INTER- CHANGES WITH	INCHES						
			TUBE O.D.	NPT PIPE THREAD	A	C	H	L	W HEX
2-2-2 OBZ	2FBT2N	200-3-2TTF	1/8	1/8	1.91	1.01	.075	0.70	1/2
3-3-2 OBZ	3FBT2N	300-3-2TTF	3/16	1/8	2.02	1.01	0.75	0.74	1/2
4-4-2 OBZ	4FBT2N	400-3-2TTF	1/4	1/8	2.12	1.06	0.75	0.77	1/2
4-4-4 OBZ	4FBT4N	400-3-4TTF	1/4	1/4	2.34	1.17	0.88	0.88	11/16
5-5-2 OBZ	5FBT2N	500-3-2TTF	5/16	1/8	2.34	1.17	0.75	0.88	5/8
6-6-4 OBZ	6FBT4N	600-3-4TTF	3/8	1/4	2.46	1.23	0.88	0.94	11/16
8-8-4 OBZ	8FBT4N	810-3-4TTF	1/2	1/4	2.84	1.42	0.88	1.02	13/16
8-8-6 OBZ	8FBT6N	810-3-6TTF	1/2	3/8	2.84	1.42	0.88	1.02	7/8
8-8-8 OBZ	8FBT8N	810-3-8TTF	1/2	1/2	3.06	1.53	1.13	1.13	1
10-10-8 OBZ	10FBT8N	1010-3-8TTF	5/8	1/2	3.06	1.53	1.13	1.13	1
12-12-12 OBZ	12FBT12N	1210-3-12TTF	3/4	3/4	3.52	1.76	1.25	1.36	1-3/8
14-14-12 OBZ	14FBT12N	1410-3-12TTF	7/8	3/4	3.52	1.76	1.25	1.36	1-3/8
16-16-12 OBZ	16FBT12N	1610-3-12TTF	1	3/4	3.86	1.94	1.25	1.45	1-3/8
16-16-16 OBZ	16FBT16N	1610-3-16TTF	1	1	4.28	2.14	1.50	1.65	1-5/8

NOTE: A and C dimensions are typical finger-tight.

Dimensions for reference only, subject to change.

NPT Female Branch Tee For metric tube

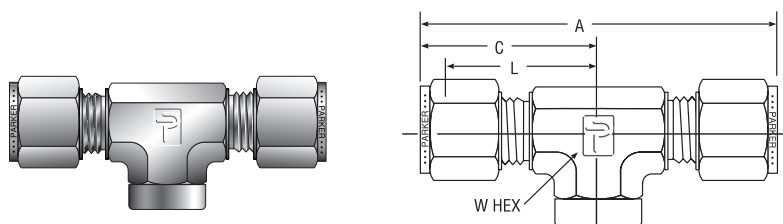

CPI™ PART NO.	A-LOK® PART NO.	INTER- CHANGES WITH	MILLIMETERS						INCHES
			TUBE O.D.	NPT THREAD	A	C	H	L	W HEX
OBZ 6-6-1/8	M6FBT1/8N	6MO-3TTF	6	1/8	53,9	27,0	19,0	19,6	1/2
OBZ 6-6-1/4	M6FBT1/4N	6MO-3-4TTF	6	1/4	59,5	29,8	22,4	22,4	11/16
OBZ 8-8-1/8	M8FBT1/8N	8MO-3TTF	8	1/8	59,7	29,9	19,0	22,4	5/8
OBZ 10-10-1/4	M10FBT1/4N	10MO-3TTF	10	1/4	67,0	33,5	22,4	25,9	13/16
OBZ 12-12-1/8	M12FBT1/8N	12MO-3TTF	12	1/8	72,0	36,0	22,3	25,9	13/16
OBZ 12-12-1/4	M12FBT1/4N	12MO-3-4TTF	12	1/4	72,0	36,0	22,3	25,9	13/16
OBZ 12-12-3/8	M12FBT3/8N	12MO-3TTF	12	3/8	72,0	36,0	22,4	25,9	13/16
OBZ 12-12-1/2	M12FBT1/2N	12MO-3-8TTF	12	1/2	77,6	38,8	28,5	28,7	1
OBZ 16-16-1/2	M16FBT1/2N	16MO-3TTF	16	1/2	77,6	38,8	28,4	28,7	1

NOTE: A and C dimensions are typical finger-tight.

Dimensions for reference only, subject to change.

Union
For fractional tube

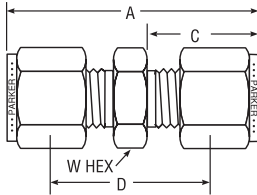
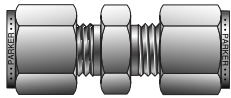

CPI™ PART NO.	A-LOK® PART NO.	INTER- CHANGES WITH	INCHES				
			TUBE O.D.	A	C	D	W HEX
1-1 HBZ	1SC1	100-6	1/16	0.99	0.43	0.69	5/16
2-2 HBZ	2SC2	200-6	1/8	1.39	0.60	0.88	7/16
3-3 HBZ	3SC3	300-6	3/16	1.48	0.64	0.95	7/16
4-4 HBZ	4SC4	400-6	1/4	1.62	0.70	1.03	1/2
5-5 HBZ	5SC5	500-6	5/16	1.70	0.73	1.11	9/16
6-6 HBZ	6SC6	600-6	3/8	1.77	0.76	1.19	5/8
8-8 HBZ	8SC8	810-6	1/2	2.02	0.87	1.22	13/16
10-10 HBZ	10SC10	1010-6	5/8	2.05	0.87	1.25	15/16
12-12 HBZ	12SC12	1210-6	3/4	2.11	0.87	1.31	1-1/16
14-14 HBZ	14SC14	1410-6	7/8	2.18	0.87	1.38	1-3/16
16-16 HBZ	16SC16	1610-6	1	2.57	1.05	1.59	1-3/8
20-20 HBZ	20SC20	2010-6	1-1/4	3.61	1.52	1.89	1-3/4
24-24 HBZ	24SC24	2410-6	1-1/2	4.23	1.77	2.11	2-1/8
32-32 HBZ	32SC32	3210-6	2	5.88	2.47	2.94	2-3/4

NOTE: A and C dimensions are typical finger-tight.

Dimensions for reference only, subject to change.

Union
For metric tube

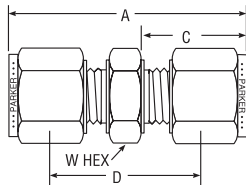
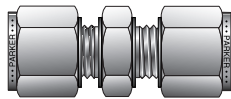

CPI™ PART NO.	A-LOK® PART NO.	INTER- CHANGES WITH	MILLIMETERS				
			TUBE O.D.	A	C	D	W HEX
HBZ 2-2	SCM2	2MO-6	2	35,6	15,3	22,4	12,0
HBZ 3-3	SCM3	3MO-6	3	35,3	15,3	22,1	12,0
HBZ 4-4	SCM4	4MO-6	4	37,4	16,1	24,2	12,0
HBZ 6-6	SCM6	6MO-6	6	41,2	17,7	26,2	14,0
HBZ 8-8	SCM8	8MO-6	8	43,2	18,6	28,2	15,0
HBZ 10-10	SCM10	10MO-6	10	46,2	19,5	31,0	18,0
HBZ 12-12	SCM12	12MO-6	12	51,2	22,0	31,0	22,0
HBZ 14-14	SCM14	14MO-6	14	52,0	22,0	31,8	24,0
HBZ 15-15	SCM15	15MO-6	15	52,0	22,0	31,8	24,0
HBZ 16-16	SCM16	16MO-6	16	52,0	22,0	31,8	24,0
HBZ 18-18	SCM18	18MO-6	18	53,5	22,0	33,3	27,0
HBZ 20-20	SCM20	20MO-6	20	55,0	22,0	34,8	30,0
HBZ 22-22	SCM22	22MO-6	22	55,0	22,0	34,8	30,0
HBZ 25-25	SCM25	25MO-6	25	65,1	26,5	40,5	35,0

NOTE: A and C dimensions are typical finger-tight.

Dimensions for reference only, subject to change.

Color Coding

For easy reference, table column headings are color indicated as follows:

fractional



metric



Conversion Union

For metric tube
 Metric Tube to Inch Tube

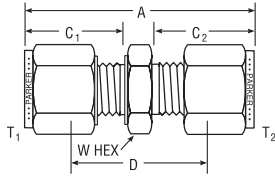
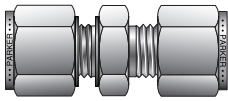

CPI™ PART NO.	A-LOK® PART NO.	INTER- CHANGES WITH	TUBE O.D.		MILLIMETERS				
			T ₁ MM	T ₂ INCH	A	C ₁	C ₂	D	W HEX
HBZ 3-1/8	M3CU2	3MO-6-2	3	1/8	36,3	15,3	15,3	22,6	12,0
HBZ 4-1/8	M4CU2	4MO-6-2	4	1/8	36,5	16,1	15,3	23,6	12,0
HBZ 4-1/4	M4CU4	4MO-6-4	4	1/4	39,3	16,1	17,7	26,4	14,0
HBZ 6-1/8	M6CU2	6MO-6-2	6	1/8	38,5	17,7	15,3	24,6	14,0
HBZ 6-1/4	M6CU4	6MO-6-4	6	1/4	41,1	17,7	17,7	25,9	14,0
HBZ 6-5/16	M6CU5	6MO-6-5	6	5/16	42,3	17,7	18,8	27,2	14,0
HBZ 8-1/4	M8CU4	8MO-6-4	8	1/4	42,3	18,6	17,7	27,2	15,0
HBZ 8-3/8	M8CU6	8MO-6-6	8	3/8	44,0	18,6	19,3	29,1	15,0
HBZ 10-1/8	M10CU2	10MO-6-2	10	1/8	41,8	19,5	15,3	27,9	18,0
HBZ 10-1/4	M10CU4	10MO-6-4	10	1/4	44,5	19,5	17,7	29,2	18,0
HBZ 10-3/8	M10CU6	10MO-6-6	10	3/8	46,0	19,5	19,3	30,7	18,0
HBZ 12-3/8	M12CU6	12MO-6-6	12	3/8	48,4	22,0	19,3	30,7	22,0
HBZ 12-1/2	M12CU8	12MO-6-8	12	1/2	51,1	22,0	21,8	31,0	22,0
HBZ 15-1/2	M15CU8	15MO-6-8	15	1/2	52,0	22,0	21,8	32,0	24,0
HBZ 16-3/8	M16CU6	16MO-6-6	16	3/8	52,0	22,0	19,3	34,3	24,0
HBZ 18-3/4	M18CU12	18MO-6-12	18	3/4	53,5	22,0	21,8	33,5	27,0

NOTE: A, C₁ and C₂ dimensions are typical finger-tight.

Dimensions for reference only, subject to change.

Reducing Union

For fractional tube

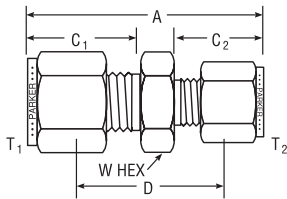
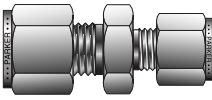

CPI™ PART NO.	A-LOK® PART NO.	INTER- CHANGES WITH	INCHES						
			T ₁ TUBE O.D.	T ₂ TUBE O.D.	A	C ₁	C ₂	D	W HEX
2-1 HBZ	2RU1	200-6-1	1/8	1/16	1.21	0.60	.43	0.81	7/16
3-1 HBZ	3RU1	300-6-1	3/16	1/16	1.27	0.64	.43	0.86	7/16
3-2 HBZ	3RU2	300-6-2	3/16	1/8	1.44	0.64	.60	0.92	7/16
4-1 HBZ	4RU1	400-6-1	1/4	1/16	1.38	0.70	.43	0.91	1/2
4-2 HBZ	4RU2	400-6-2	1/4	1/8	1.52	0.70	.60	0.97	1/2
4-3 HBZ	4RU3	400-6-3	1/4	3/16	1.55	0.70	.64	1.00	1/2
5-2 HBZ	5RU2	500-6-2	5/16	1/8	1.58	0.73	.60	1.03	9/16
5-4 HBZ	5RU4	500-6-4	5/16	1/4	1.67	0.73	.70	1.08	9/16
6-1 HBZ	6RU1	600-6-1	3/8	1/16	1.44	0.76	.43	1.00	5/8
6-2 HBZ	6RU2	600-6-2	3/8	1/8	1.61	0.76	.60	1.06	5/8
6-4 HBZ	6RU4	600-6-4	3/8	1/4	1.71	0.76	.70	1.13	5/8
6-5 HBZ	6RU5	600-6-5	3/8	5/16	1.75	0.76	.73	1.16	5/8
8-2 HBZ	8RU2	810-6-2	1/2	1/8	1.75	0.87	.60	1.09	13/16
8-4 HBZ	8RU4	810-6-4	1/2	1/4	1.85	0.87	.70	1.16	13/16
8-6 HBZ	8RU6	810-6-6	1/2	3/8	1.91	0.87	.76	1.22	13/16
10-6 HBZ	10RU6	1010-6-6	5/8	3/8	1.94	0.87	.76	1.25	15/16
10-8 HBZ	10RU8	1010-6-8	5/8	1/2	2.05	0.87	.87	1.25	15/16
12-4 HBZ	12RU4	1210-6-4	3/4	1/4	1.95	0.87	.76	1.25	1-1/16
12-6 HBZ	12RU6	1210-6-6	3/4	3/8	2.00	0.87	.76	1.31	1-1/16
12-8 HBZ	12RU8	1210-6-8	3/4	1/2	2.11	0.87	.87	1.31	1-1/16
12-10 HBZ	12RU10	1210-6-10	3/4	5/8	2.11	0.87	.87	1.31	1-1/16
16-8 HBZ	16RU8	1610-6-8	1	1/2	2.39	1.05	.87	1.50	1-3/8
16-12 HBZ	16RU12	1610-6-12	1	3/4	2.39	1.05	.87	1.50	1-3/8

NOTE: A, C₁ and C₂ dimensions are typical finger-tight.

Dimensions for reference only, subject to change.

Reducing Union

For metric tube

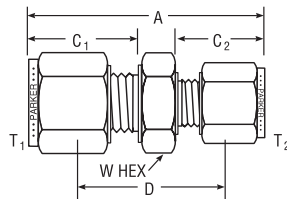
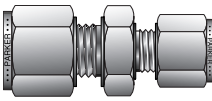

CPI™ PART NO.	A-LOK® PART NO.	INTER- CHANGES WITH	MILLIMETERS						
			T ₁ TUBE O.D.	T ₂ TUBE O.D.	A	C ₁	C ₂	D	W HEX
HBZ 3-2	M3RUM2	3MO-6-2M	3	2	35,8	15,3	15,3	22,6	12,0
HBZ 6-2	M6RUM2	6MO-6-2M	6	2	38,7	17,7	15,3	24,6	14,0
HBZ 6-3	M6RUM3	6MO-6-3M	6	3	38,7	17,7	15,3	24,6	14,0
HBZ 6-4	M6RUM4	6MO-6-4M	6	4	39,5	17,7	16,1	25,4	14,0
HBZ 8-6	M8RUM6	8MO-6-6M	8	6	42,4	18,6	17,7	27,4	15,0
HBZ 10-6	M10RUM6	10MO-6-6M	10	6	44,5	19,5	17,7	29,4	18,0
HBZ 10-8	M10RUM8	10MO-6-8M	10	8	44,5	19,5	18,6	29,4	18,0
HBZ 12-6	M12RUM6	12MO-6-6M	12	6	47,0	22,0	17,7	29,4	22,0
HBZ 12-8	M12RUM8	12MO-6-8M	12	8	47,8	22,0	18,6	30,2	22,0
HBZ 12-10	M12RUM10	12MO-6-10M	12	10	48,7	22,0	19,5	31,0	22,0
HBZ 16-10	M16RUM10	16MO-6-10M	16	10	49,5	22,0	19,5	31,8	24,0
HBZ 16-12	M16RUM12	16MO-6-12M	16	12	52,0	22,0	22,0	31,8	24,0
HBZ 18-12	M18RUM12	18MO-6-12M	18	12	53,5	22,0	22,0	33,3	27,0
HBZ 25-18	M25RUM18	25MO-6-18M	25	18	60,5	26,5	22,0	38,1	35,0
HBZ 25-20	M25RUM20	25MO-6-20M	25	20	62,3	26,5	22,0	39,9	35,0

NOTE: A, C₁ and C₂ dimensions are typical finger-tight.

Dimensions for reference only, subject to change.

Bulkhead Union For fractional tube

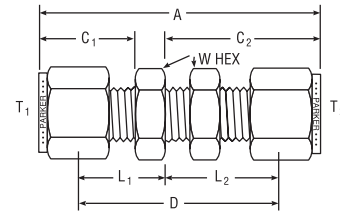
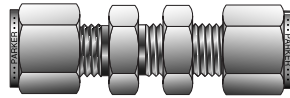

CPI™ PART NO.	A-LOK® PART NO.	INTER- CHANGES WITH	INCHES									
			TUBE O.D.	A	C ₁	C ₂	D	L ₁	L ₂	W HEX	BULKHEAD HOLE DRILL SIZE	MAXIMUM BULKHEAD THICKNESS
1-1 WBZ	1BC1	100-61	1/16	1.23	.43	0.68	0.94	.28	0.53	5/16	13/64	1/8
2-2 WBZ	2BC2	200-61	1/8	2.02	.60	1.23	1.50	.34	0.97	1/2	21/64	1/2
2-4 WBZ	2BC4	400-61-2	1/8 - 1/4	2.17	.60	1.62	1.31	.34	1.02	5/8	29/64	17/32
3-3 WBZ	3BC3	300-61	3/16	2.11	.64	1.26	1.59	.38	1.00	9/16	25/64	1/2
4-2 WBZ	4BC2	200-61-4	1/4 - 1/8	2.18	.70	1.23	1.62	.41	0.97	1/2	21/64	1/2
4-4 WBZ	4BC4	400-61	1/4	2.27	.70	1.31	1.69	.41	1.02	5/8	29/64	17/32
5-5 WBZ	5BC5	500-61	5/16	2.40	.73	1.42	1.81	.44	1.12	11/16	33/64	9/16
6-6 WBZ	6BC6	600-61	3/8	2.46	.76	1.44	1.88	.47	1.16	3/4	37/64	9/16
8-8 WBZ	8BC8	810-61	1/2	2.80	.87	1.65	2.00	.47	1.25	15/16	49/64	19/32
10-10 WBZ	10BC10	1010-61	5/8	2.86	.87	1.68	2.06	.47	1.28	1-1/16	57/64	19/32
12-12 WBZ	12BC12	1210-61	3/4	3.11	.87	1.87	2.31	.47	1.47	1-3/16	1-1/64	25/32
14-14 WBZ	14BC14	1410-61	7/8	3.33	.87	2.09	2.53	.47	1.69	1-3/8	1-9/64	15/16
16-16 WBZ	16BC16	1610-61	1	3.78	1.05	2.27	2.81	.56	1.78	1-5/8	1-21/64	15/16

NOTE: For reducer sizes call out short end first.

Dimensions for reference only, subject to change.

A, C₁ and C₂ dimensions are typical finger-tight.
 For replacement bulkhead nuts, see page 77, Part WLZ.

Bulkhead Union For metric tube

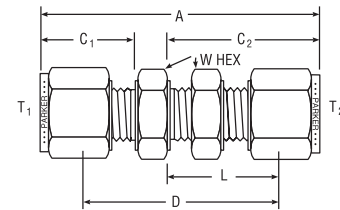
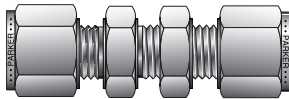

CPI™ PART NO.	A-LOK® PART NO.	INTER- CHANGES WITH	MILLIMETERS								
			TUBE O.D.	A	C ₁	C ₂	D	L	W HEX	B'HEAD HOLE DRILL SIZE	MAX. B'HEAD THICK.
WBZ 3-3	BCM3	3MO-61	3	51,3	15,3	31,2	38,2	24,6	14,0	8,3	12,7
WBZ 4-4	BCM4	4MO-61	4	53,7	16,1	32,0	40,5	25,4	14,0	9,9	12,7
WBZ 6-6	BCM6	6MO-61	6	57,9	17,7	33,7	42,9	26,2	16,0	11,5	10,2
WBZ 8-8	BCM8	8MO-61	8	61,0	18,6	36,0	46,0	28,5	18,0	13,1	11,2
WBZ 10-10	BCM10	10MO-61	10	63,6	19,5	37,0	48,4	29,4	22,0	16,3	11,2
WBZ 12-12	BCM12	12MO-61	12	71,0	22,0	41,9	50,8	31,8	24,0	19,5	12,7
WBZ 15-15	BCM15	15MO-61	15	72,5	22,0	42,6	52,3	32,5	27,0	22,5	12,7
WBZ 16-16	BCM16	16MO-61	16	72,6	22,0	42,6	52,4	32,5	27,0	22,5	12,7
WBZ 18-18	BCM18	18MO-61	18	78,9	22,0	47,4	58,7	37,3	30,0	26,0	16,8
WBZ 20-20	BCM20	20MO-61	20	88,2	22,0	51,0	68,0	40,9	35,0	29,0	19,0
WBZ 25-25	BCM25	25MO-61	25	95,8	26,5	54,4	71,4	42,2	41,0	33,8	24,0

NOTE: A, C₁ and C₂ dimensions are typical finger-tight.

Dimensions for reference only, subject to change.

For replacement bulkhead nuts, see page 77, Part BN.
 For reducer sizes call out short end first.

Color Coding

For easy reference, table column headings are color indicated as follows:

fractional



metric



Dielectric Union Adapter For fractional tube

includes nuts, machined tube with molded PEEK¹⁾ insulator, preset ferrule, and dielectric identification ring

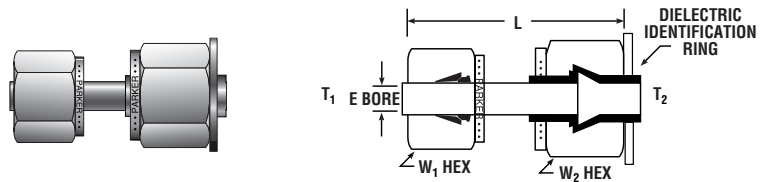

CPI™ ADAPTER PART NO.	A-LOK® ADAPTER PART NO.	INCHES							PRESSURE RATING @ 70°F LIQUID / GAS (PSI)
		T ₁ TUBE END	T ₂ TUBE END	L	E BORE	W1 HEX	W2 HEX		
6-8 DEBTA-SS	6-8 DELTA	3/8	1/2	2.08	.30	11/16	7/8	4000 / 3000	
8-10 DEBTA-SS	N/A	1/2	5/8	2.58	.38	7/8	1	3000 / 2000	

*Other end connectors available upon request.

Dimensions for reference only, subject to change.

1) Polyetherether Ketone

NOTE: Makeup instructions included with parts in box when ordered as an Adapter only.

Dielectric Resistivity 10x10⁹ OHMS @ 500 volts DC (Tested on Mil-STD-202F)

Dielectric withstanding voltage less than 100 microamps leakage @ 1500 volts AC

AMBIENT TEMPERATURE, °F	-40	-20	0	20	40	60	80	100	120	140	160	180	200
TEMPERATURE DERATING FACTOR	1.00	1.00	1.00	1.00	1.00	1.00	1.00	0.93	0.86	0.79	0.72	0.64	0.56

Dielectric Assembly For fractional tube

includes dielectric union adapter with assembled tube fitting unions

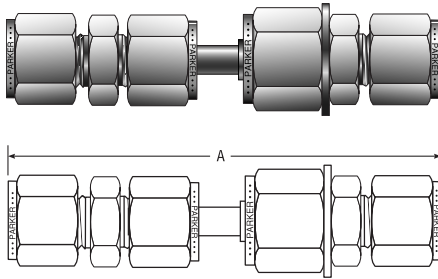

CPI™ ASSEMBLY PART NO.	A-LOK® ASSEMBLY PART NO.	INCHES	END ADAPTORS
*COMPRESSION	*COMPRESSION	A†	
4H DEBTA	4H DELTA	4.08	6RU4/8RU4
6H DEBTA	6H DELTA	4.20	6SC6/8RU6
8H DEBTA	8H DELTA	4.79	8SC8/10RU8
FEMALE PIPE	FEMALE PIPE	A	END ADAPTORS
4G DEBTA	4G DELTA	3.59	6FSC4N/8FSC4N
6G DEBTA	6G DELTA	3.71	6FSC6N/8FSC6N
8G DEBTA	8G DELTA	4.40	8FSC8N/10FSC8N
MALE PIPE	MALE PIPE	A	END ADAPTORS
4F DEBTA	4F DELTA	3.80	6MSC4N/8MSC4N
6F DEBTA	6F DELTA	3.80	6MSC6N/8MSC6N
8F DEBTA	8F DELTA	4.58	8MSC8N/10MSC8N

†Finger tight assembly dimensions.

Dimensions for reference only, subject to change.

Union Elbow For fractional tube

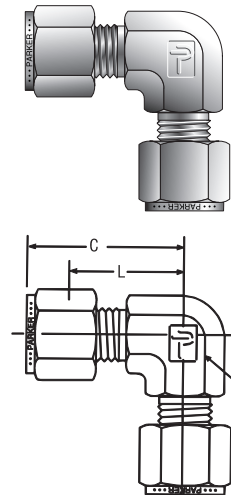

CPI™ PART NO.	A-LOK® PART NO.	INTER-CHANGES WITH	INCHES			
			TUBE O. D.	C	L	W HEX
1-1 EBZ	1EE1	100-9	1/16	.70	.55	3/8
2-2 EBZ	2EE2	200-9	1/8	.88	.62	3/8
3-3 EBZ	3EE3	300-9	3/16	1.00	.74	1/2
4-4 EBZ	4EE4	400-9	1/4	1.06	.77	1/2
5-5 EBZ	5EE5	500-9	5/16	1.13	.84	9/16
6-6 EBZ	6EE6	600-9	3/8	1.20	.91	5/8
8-8 EBZ	8EE8	810-9	1/2	1.42	1.02	13/16
10-10 EBZ	10EE10	1010-9	5/8	1.50	1.10	15/16
12-12 EBZ	12EE12	1210-9	3/4	1.57	1.17	1-1/16
14-14 EBZ	14EE14	1410-9	7/8	1.76	1.36	1-3/8
16-16 EBZ	16EE16	1610-9	1	1.93	1.45	1-3/8
20-20 EBZ	20EE20	2010-9	1-1/4	2.61	1.75	1-5/8
24-24 EBZ	24EE24	2410-9	1-1/2	3.06	2.00	1-7/8
32-32 EBZ	32EE32	3210-9	2	4.22	2.75	2-13/16

NOTE: C dimension is typical finger-tight.

Dimensions for reference only, subject to change.

Sizes 20, 24, 32 require additional lubrication prior to assembly.

Union Elbow For metric tube

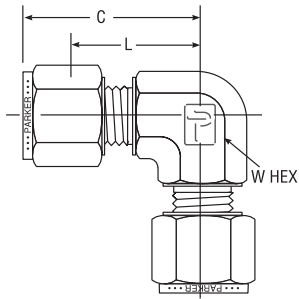
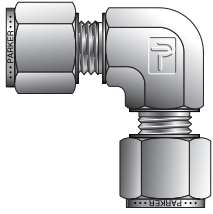

CPI™ PART NO.	A-LOK® PART NO.	INTER- CHANGES WITH	MILLIMETERS			INCHES
			TUBE O.D.	C	L	W HEX
EBZ 3-3	EEM3	3MO-9	3	22,3	15,7	3/8
EBZ 4-4	EEM4	4MO-9	4	25,4	18,8	1/2
EBZ 6-6	EEM6	6MO-9	6	27,0	19,6	1/2
EBZ 8-8	EEM8	8MO-9	8	28,8	21,3	9/16
EBZ 10-10	EEM10	10MO-9	10	31,5	23,9	11/16
EBZ 12-12	EEM12	12MO-9	12	36,0	25,9	13/16
EBZ 14-14	EEM14	14MO-9	14	38,1	28,0	15/16
EBZ 15-15	EEM15	15MO-9	15	38,0	27,9	15/16
EBZ 16-16	EEM16	16MO-9	16	38,0	27,9	15/16
EBZ 18-18	EEM18	18MO-9	18	39,8	29,7	1-1/16
EBZ 20-20	EEM20	20MO-9	20	44,6	34,5	1-3/8
EBZ 22-22	EEM22	22MO-9	22	44,6	34,5	1-3/8
EBZ 25-25	EEM25	25MO-9	25	49,1	36,8	1-3/8

NOTE: C dimension is typical finger-tight.

Dimensions for reference only, subject to change.

Drop Size Elbows For fractional tube

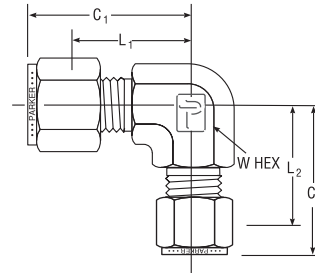
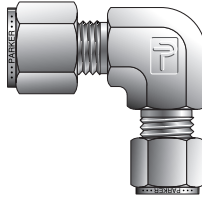

CPI™ PART NO.	A-LOK® PART NO.	INTER- CHANGES WITH	INCHES					W HEX
			TUBE O.D.	L ₁	C ₁	L ₂	C ₂	
3-2 EBZ	3-2 ELZ	300-9-2	3/16-1/8	0.74	1.01	0.70	0.96	1/2
4-2 EBZ	4-2 ELZ	400-9-2	1/4-1/8	0.77	1.06	0.70	0.96	1/2
5-2 EBZ	5-2 ELZ	500-9-2	5/16-1/8	0.88	1.17	0.78	1.04	5/8
5-4 EBZ	5-4 ELZ	500-9-4	5/16-1/4	0.88	1.17	0.85	1.14	5/8
6-2 EBZ	6-2 ELZ	600-9-2	3/8-1/8	0.91	1.20	0.78	1.04	5/8
6-4 EBZ	6-4 ELZ	600-9-4	3/8-1/4	0.91	1.20	0.85	1.17	5/8
6-5 EBZ	6-5 ELZ	600-9-5	3/8-5/16	0.91	1.20	0.88	1.17	5/8
8-4 EBZ	8-4 ELZ	810-9-4	1/2-1/4	1.02	1.42	0.96	1.25	13/16
8-5 EBZ	8-5 ELZ	810-9-5	1/2-5/16	1.02	1.42	0.99	1.28	13/16
8-6 EBZ	8-6 ELZ	810-9-6	1/2-3/8	1.02	1.42	1.02	1.31	13/16
10-6 EBZ	10-6 ELZ	1010-9-6	5/8-3/8	1.10	1.50	1.10	1.39	15/16
10-8 EBZ	10-8 ELZ	1010-9-8	5/8-1/2	1.10	1.50	1.10	1.50	15/16
12-4 EBZ	12-4 ELZ	1210-9-4	3/4-1/4	1.16	1.56	1.10	1.39	1-1/16
12-6 EBZ	12-6 ELZ	1210-9-6	3/4-3/8	1.16	1.56	1.16	1.45	1-1/16
12-8 EBZ	12-8 ELZ	1210-9-8	3/4-1/2	1.16	1.56	1.16	1.56	1-1/16
14-4 EBZ	14-4 ELZ	1410-9-4	7/8-1/4	1.36	1.76	1.30	1.59	1-3/8
16-8 EBZ	16-8 ELZ	1610-9-8	1-1/2	1.45	1.94	1.36	1.76	1-3/8
16-12 EBZ	16-12 ELZ	1610-9-12	1-3/4	1.45	1.94	1.36	1.76	1-3/8

NOTE: C dimension is typical finger-tight.

Dimensions for reference only, subject to change.

Color Coding

For easy reference, table column headings are color indicated as follows:

fractional



metric



Union Tee
For fractional tube

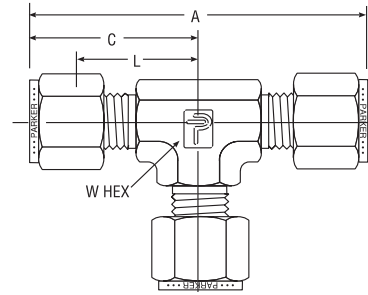
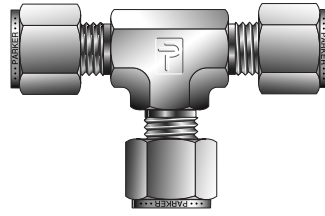

CPI™ PART NO.	A-LOK® PART NO.	INTER- CHANGES WITH	INCHES				
			TUBE O.D.	A	C	L	W HEX
1-1-1 JBZ	1ET1	100-3	1/16	1.42	0.71	0.56	3/8
2-2-2 JBZ	2ET2	200-3	1/8	1.76	0.88	0.62	3/8
3-3-3 JBZ	3ET3	300-3	3/16	1.96	0.96	0.70	7/16
4-4-4 JBZ	4ET4	400-3	1/4	2.12	1.06	0.77	1/2
5-5-5 JBZ	5ET5	500-3	5/16	2.34	1.17	0.88	5/8
6-6-6 JBZ	6ET6	600-3	3/8	2.40	1.20	0.91	5/8
8-8-8 JBZ	8ET8	810-3	1/2	2.84	1.42	1.02	13/16
10-10-10 JBZ	10ET10	1010-3	5/8	3.06	1.53	1.13	1
12-12-12 JBZ	12ET12	1210-3	3/4	3.14	1.57	1.16	1-1/16
14-14-14 JBZ	14ET14	1410-3	7/8	3.52	1.76	1.36	1-3/8
16-16-16 JBZ	16ET16	1610-3	1	3.86	1.93	1.45	1-3/8
20-20-20 JBZ	20ET20	2010-3	1-1/4	5.22	2.61	1.75	1-5/8
24-24-24 JBZ	24ET24	2410-3	1-1/2	6.12	3.06	2.00	1-7/8
32-32-32 JBZ	32ET32	3210-3	2	8.44	4.22	2.75	2-13/16

NOTE: A and C dimensions are typical finger-tight.

Dimensions for reference only, subject to change.

Sizes 20, 24, 32 require additional lubrication prior to assembly.

Union Tee
For metric tube

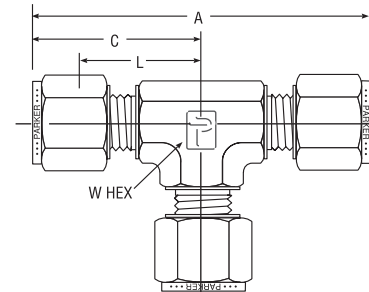
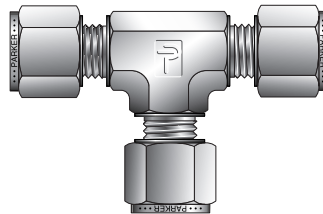

CPI™ PART NO.	A-LOK® PART NO.	INTER- CHANGES WITH	MILLIMETERS				INCHES
			TUBE O.D.	A	C	L	W HEX
JBZ 2-2-2	ETM2	2MO-3	2	44,7	22,3	15,7	3/8
JBZ 3-3-3	ETM3	3MO-3	3	44,7	22,3	15,7	3/8
JBZ 4-4-4	ETM4	4MO-3	4	50,8	25,4	18,8	1/2
JBZ 6-6-6	ETM6	6MO-3	6	53,9	27,0	19,6	1/2
JBZ 8-8-8	ETM8	8MO-3	8	59,7	29,9	22,4	5/8
JBZ 10-10-10	ETM10	10MO-3	10	63,0	31,5	23,9	11/16
JBZ 12-12-12	ETM12	12MO-3	12	72,0	36,0	25,9	13/16
JBZ 14-14-14	ETM14	14MO-3	14	77,6	38,8	28,7	1
JBZ 15-15-15	ETM15	15MO-3	15	77,6	38,8	28,7	1
JBZ 16-16-16	ETM16	16MO-3	16	77,6	38,8	28,7	1
JBZ 18-18-18	ETM18	18MO-3	18	79,5	38,8	29,7	1-1/16
JBZ 20-20-20	ETM20	20MO-3	20	89,3	44,6	34,5	1-3/8
JBZ 22-22-22	ETM22	22MO-3	22	89,3	44,6	34,5	1-3/8
JBZ 25-25-25	ETM25	25MO-3	25	98,3	49,1	36,8	1-3/8

NOTE: A and C dimensions are typical finger-tight.

Dimensions for reference only, subject to change.

Drop Size Tees
For fractional tube

Eliminates the extra connection when adapting with a tube stub reducer

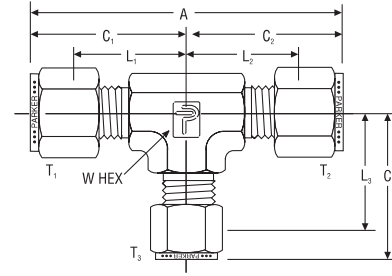
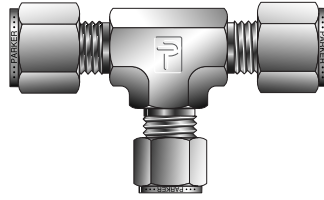

CPTM PART NO.	A-LOK® PART NO.	INTER- CHANGES WITH	INCHES										
			T ₁ TUBE O.D.	T ₂ TUBE O.D.	T ₃ TUBE O.D.	A	L ₁	C ₁	L ₂	C ₂	L ₃	C ₃	W HEX
4-4-2 JBZ	4-4-2 JLZ	400-3-4-2	1/4	1/4	1/8	2.10	0.76	1.05	0.76	1.05	0.70	0.96	1/2
6-6-4 JBZ	6-6-4 JLZ	600-3-6-4	3/8	3/8	1/4	2.40	0.91	1.20	0.91	1.20	0.85	1.14	5/8
6-4-6 JBZ	6-4-6 JLZ	600-3-4-6	3/8	1/4	3/8	2.34	0.91	1.20	0.85	1.14	0.91	1.20	5/8
6-4-4 JBZ	6-4-4 JLZ	600-3-4-4	3/8	1/4	1/4	2.34	0.91	1.20	0.85	1.14	0.85	1.14	5/8
8-8-6 JBZ	8-8-6 JLZ	810-3-8-6	1/2	1/2	3/8	2.84	1.02	1.42	1.02	1.42	1.02	1.31	13/16
8-8-4 JBZ	8-8-4 JLZ	810-3-8-4	1/2	1/2	1/4	2.84	1.02	1.42	1.02	1.42	0.96	1.25	13/16
8-6-8 JBZ	8-6-8 JLZ	810-3-6-8	1/2	3/8	1/2	2.73	1.02	1.42	1.02	1.31	1.02	1.42	13/16
8-4-8 JBZ	8-4-8 JLZ	810-3-4-8	1/2	1/4	1/2	2.67	1.02	1.42	0.96	1.25	1.02	1.42	13/16
8-6-6 JBZ	8-6-6 JLZ	810-3-6-6	1/2	3/8	3/8	2.73	1.02	1.42	1.02	1.31	1.02	1.31	13/16
8-4-4 JBZ	8-4-4 JLZ	810-3-4-4	1/2	1/4	1/4	2.67	1.02	1.42	.96	1.25	.96	1.25	13/16
10-10-8 JBZ	10-10-8 JLZ	1010-3-10-8	5/8	5/8	1/2	3.06	1.13	1.53	1.13	1.53	1.13	1.53	7/8
10-10-6 JBZ	10-10-6 JLZ	1010-3-10-6	5/8	5/8	3/8	3.06	1.13	1.53	1.13	1.53	1.13	1.53	7/8
10-8-8 JBZ	10-8-8 JLZ	1010-3-8-8	5/8	1/2	1/2	3.06	1.13	1.53	1.13	1.53	1.13	1.53	7/8
10-8-6 JBZ	10-8-6 JLZ	1010-3-8-6	5/8	1/2	3/8	3.06	1.13	1.53	1.13	1.53	1.13	1.42	7/8
10-6-6 JBZ	10-6-6 JLZ	1010-3-6-6	5/8	3/8	3/8	2.95	1.13	1.53	1.13	1.42	1.13	1.42	7/8
10-6-8 JBZ	10-6-8 JLZ	1010-3-6-8	5/8	3/8	1/2	2.95	1.13	1.53	1.13	1.42	1.13	1.53	7/8
12-12-10 JBZ	12-12-10 JLZ	1210-3-12-10	3/4	3/4	5/8	3.12	1.16	1.56	1.16	1.56	1.16	1.56	1-1/16
12-12-8 JBZ	12-12-8 JLZ	1210-3-12-8	3/4	3/4	1/2	3.12	1.16	1.56	1.16	1.56	1.16	1.56	1-1/16
12-12-6 JBZ	12-12-6 JLZ	1210-3-12-6	3/4	3/4	3/8	3.12	1.16	1.56	1.16	1.56	1.16	1.45	1-1/16
12-12-4 JBZ	12-12-4 JLZ	1210-3-12-4	3/4	3/4	1/4	3.12	1.16	1.56	1.16	1.56	1.10	1.39	1-1/16
12-10-10 JBZ	12-10-10 JLZ	1210-3-10-10	3/4	5/8	5/8	3.12	1.16	1.56	1.16	1.56	1.16	1.56	1-1/16
12-8-8 JBZ	12-8-8 JLZ	1210-3-8-8	3/4	1/2	1/2	3.12	1.16	1.56	1.16	1.56	1.16	1.56	1-1/16
12-6-6 JBZ	12-6-6 JLZ	1210-3-6-6	3/4	3/8	3/8	3.01	1.16	1.56	1.16	1.45	1.16	1.45	1-1/16
12-10-8 JBZ	12-10-8 JLZ	1210-3-10-8	3/4	5/8	1/2	3.12	1.16	1.56	1.16	1.56	1.16	1.56	1-1/16
12-10-6 JBZ	12-10-6 JLZ	1210-3-10-6	3/4	5/8	3/8	3.12	1.16	1.56	1.16	1.56	1.16	1.45	1-1/16
12-8-6 JBZ	12-8-6 JLZ	1210-3-8-6	3/4	1/2	3/8	3.12	1.16	1.56	1.16	1.56	1.16	1.45	1-1/16
14-14-6 JBZ	14-14-6 JLZ	1410-3-14-6	7/8	7/8	3/8	3.52	1.36	1.76	1.36	1.76	1.36	1.65	1-3/8
14-14-4 JBZ	14-14-4 JLZ	1410-3-14-4	7/8	7/8	1/4	3.52	1.36	1.76	1.36	1.76	1.30	1.59	1-3/8
14-12-12 JBZ	14-12-12 JLZ	1410-3-12-12	7/8	3/4	3/4	3.52	1.36	1.76	1.36	1.76	1.36	1.76	1-3/8
14-12-8 JBZ	14-12-8 JLZ	1410-3-12-8	7/8	3/4	1/2	3.52	1.36	1.76	1.36	1.76	1.36	1.76	1-3/8
14-12-6 JBZ	14-12-6 JLZ	1410-3-12-6	7/8	3/4	3/8	3.52	1.36	1.76	1.36	1.76	1.36	1.65	1-3/8
14-10-6 JBZ	14-10-6 JLZ	1410-3-10-6	7/8	5/8	3/8	3.52	1.36	1.76	1.36	1.76	1.36	1.65	1-3/8
14-8-12 JBZ	14-8-12 JLZ	1410-3-8-12	7/8	1/2	3/4	3.52	1.36	1.76	1.36	1.76	1.36	1.76	1-3/8
16-16-12 JBZ	16-16-12 JLZ	1610-3-16-12	1	1	3/4	3.88	1.45	1.94	1.45	1.94	1.36	1.76	1-3/8
16-16-10 JBZ	16-16-10 JLZ	1610-3-16-10	1	1	5/8	3.88	1.45	1.94	1.45	1.94	1.36	1.76	1-3/8
16-16-8 JBZ	16-16-8 JLZ	1610-3-16-8	1	1	1/2	3.88	1.45	1.94	1.45	1.94	1.36	1.76	1-3/8
16-16-6 JBZ	16-16-6 JLZ	1610-3-16-6	1	1	3/8	3.88	1.45	1.94	1.45	1.94	1.36	1.65	1-3/8
16-16-4 JBZ	16-16-4 JLZ	1610-3-16-4	1	1	1/4	3.88	1.45	1.94	1.45	1.94	1.30	1.59	1-3/8
16-12-16 JBZ	16-12-16 JLZ	1610-3-12-16	1	3/4	1	3.70	1.45	1.94	1.36	1.76	1.45	1.94	1-3/8
16-14-14 JBZ	16-14-14 JLZ	1610-3-14-14	1	7/8	7/8	3.70	1.45	1.94	1.36	1.76	1.36	1.76	1-3/8
16-14-12 JBZ	16-14-12 JLZ	1610-3-14-12	1	7/8	3/4	3.70	1.45	1.94	1.36	1.76	1.36	1.76	1-3/8
16-14-8 JBZ	16-14-8 JLZ	1610-3-14-8	1	7/8	1/2	3.70	1.45	1.94	1.36	1.76	1.36	1.76	1-3/8
16-14-6 JBZ	16-14-6 JLZ	1610-3-14-6	1	7/8	3/8	3.70	1.45	1.94	1.36	1.76	1.36	1.65	1-3/8
16-14-4 JBZ	16-14-4 JLZ	1610-3-14-4	1	7/8	1/4	3.70	1.45	1.94	1.36	1.76	1.30	1.59	1-3/8
16-16-14 JBZ	16-16-14 JLZ	1610-3-16-14	1	1	7/8	3.88	1.45	1.94	1.45	1.94	1.36	1.76	1-3/8
16-12-10 JBZ	16-12-10 JLZ	1610-3-12-10	1	3/4	5/8	3.70	1.45	1.94	1.36	1.76	1.36	1.76	1-3/8
16-12-8 JBZ	16-12-8 JLZ	1610-3-12-8	1	3/4	1/2	3.70	1.45	1.94	1.36	1.76	1.36	1.76	1-3/8
16-10-6 JBZ	16-10-6 JLZ	1610-3-10-6	1	5/8	3/8	3.70	1.45	1.94	1.36	1.76	1.36	1.65	1-3/8
16-8-16 JBZ	16-8-16 JLZ	1610-3-8-16	1	1/2	1	3.70	1.45	1.94	1.36	1.76	1.45	1.94	1-3/8
16-8-8 JBZ	16-8-8 JLZ	1610-3-8-8	1	1/2	1/2	3.70	1.45	1.94	1.36	1.76	1.36	1.76	1-3/8
16-8-6 JBZ	16-8-6 JLZ	1610-3-8-6	1	1/2	3/8	3.70	1.45	1.94	1.36	1.76	1.36	1.65	1-3/8
16-8-4 JBZ	16-8-4 JLZ	1610-3-8-4	1	1/2	1/4	3.70	1.45	1.94	1.36	1.76	1.30	1.59	1-3/8
16-6-6 JBZ	16-6-6 JLZ	1610-3-6-6	1	3/8	3/8	3.59	1.45	1.94	1.36	1.65	1.36	1.65	1-3/8

NOTE: C dimensions are typical finger-tight.

Dimensions for reference only, subject to change.



Union Cross For fractional tube

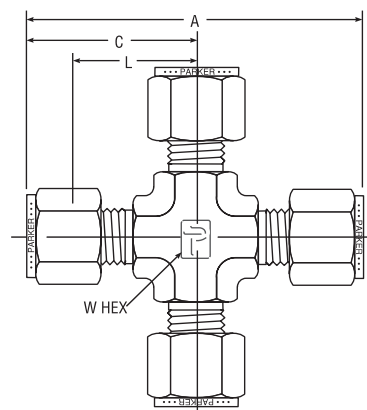
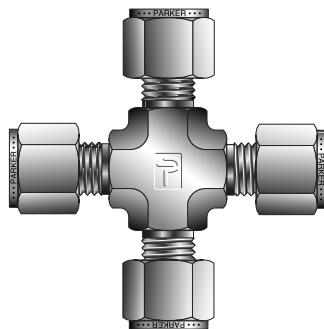

CPI™ PART NO.	A-LOK® PART NO.	INTER- CHANGES WITH	INCHES				
			TUBE O.D.	A	C	L	W HEX
2 KBZ	2ECR2	200-4	1/8	1.76	0.98	0.62	7/16
3 KBZ	3ECR3	300-4	3/16	1.83	0.96	0.70	7/16
4 KBZ	4ECR4	400-4	1/4	2.12	1.06	0.76	1/2
5 KBZ	5ECR5	500-4	5/16	2.34	1.17	0.88	5/8
6 KBZ	6ECR6	600-4	3/8	2.40	1.20	0.91	5/8
8 KBZ	8ECR8	810-4	1/2	2.84	1.42	1.02	13/16
10 KBZ	10ECR10	1010-4	5/8	3.06	1.53	1.13	1-1/16
12 KBZ	12ECR12	1210-4	3/4	3.12	1.57	1.16	1-1/16
14 KBZ	14ECR14	1410-4	7/8	3.52	1.76	1.36	1-5/16
16 KBZ	16ECR16	1610-4	1	3.86	1.93	1.45	1-5/16

NOTE: A and C dimensions are typical finger-tight.

Dimensions for reference only, subject to change.

Union Cross For metric tube

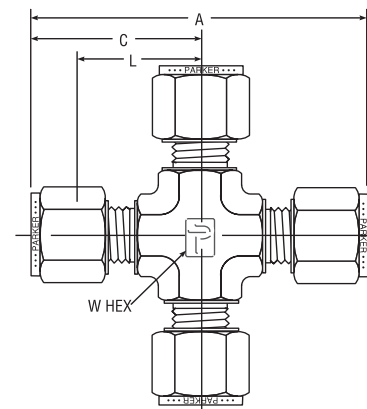
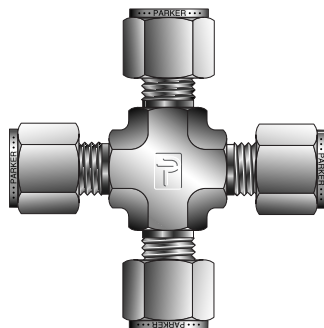

CPI™ PART NO.	A-LOK® PART NO.	INTER- CHANGES WITH	MILLIMETERS				INCHES
			TUBE O.D.	A	C	L	W HEX
KBZ 3	ECRM3	3MO-4	3	44,7	22,3	15,7	7/16
KBZ4	ECRM4	4MO-4	4	50,8	25,4	18,8	1/2
KBZ 6	ECRM6	6MO-4	6	53,9	27,0	19,6	1/2
KBZ 8	ECRM8	8MO-4	8	59,7	29,9	22,4	5/8
KBZ 10	ECRM10	10MO-4	10	67,0	33,5	25,9	13/16
KBZ 12	ECRM12	12MO-4	12	72,0	36,0	25,9	13/16
KBZ 16	ECRM16	16MO-4	16	74,0	37,0	26,9	15/16
KBZ 18	ECRM18	18MO-4	18	76,6	38,3	28,2	1-1/16

NOTE: A and C dimensions are typical finger-tight.

Dimensions for reference only, subject to change.

Color Coding

For easy reference, table column headings are color indicated as follows:

fractional



metric



Tube End Reducer
For fractional tube

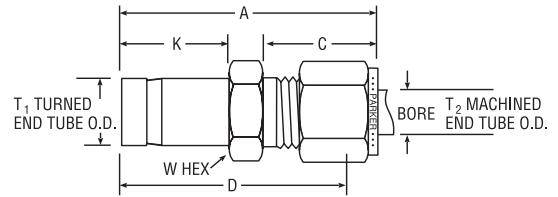
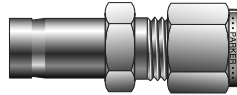

CPI™ PART NO.	A-LOK® PART NO.	INTER- CHANGES WITH	INCHES							
			T ₁ TURNED END TUBE O.D.	T ₂ MACHINED END TUBE O.D.	A	C	D	K	W HEX	BORE
2-1 TRBZ	2TUR1	100-R-2	1/8	1/16	1.10	0.43	0.95	0.53	5/16	0.05
3-1 TRBZ	3TUR1	100-R-3	3/16	1/16	1.13	0.43	0.98	0.58	5/16	0.05
4-1 TRBZ	4TUR1	100-R-4	1/4	1/16	1.24	0.43	1.09	0.63	7/16	0.05
1-2 TRBZ	1TUR2	200-R-1	1/16	1/8	1.18	0.60	0.92	0.38	7/16	0.09
2-2 TRBZ	2TUR2	200-R-2	1/8	1/8	1.34	0.43	1.09	0.54	7/16	0.07
3-2 TRBZ	3TUR2	200-R-3	3/16	1/8	1.35	0.60	1.09	0.58	7/16	0.09
4-2 TRBZ	4TUR2	200-R-4	1/4	1/8	1.42	0.60	1.16	0.63	7/16	0.09
6-2 TRBZ	6TUR2	200-R-6	3/8	1/8	1.48	0.60	1.22	0.69	7/16	0.09
8-2 TRBZ	8TUR2	200-R-8	1/2	1/8	1.74	0.60	1.48	0.91	9/16	0.09
2-3 TRBZ	2TUR3	300-R-2	1/8	3/16	1.37	0.63	1.11	0.53	7/16	0.08
4-3 TRBZ	4TUR3	300-R-4	1/4	3/16	1.46	0.63	1.20	0.63	7/16	0.13
2-4 TRBZ	2TUR4	400-R-2	1/8	1/4	1.45	0.70	1.16	0.53	1/2	0.08
3-4 TRBZ	3TUR4	400-R-3	3/16	1/4	1.48	0.60	1.19	0.56	1/2	0.12
4-4 TRBZ	4TUR4	400-R-4	1/4	1/4	1.54	0.70	1.25	0.63	1/2	0.16
5-4 TRBZ	5TUR4	400-R-5	5/16	1/4	1.57	0.70	1.28	0.66	1/2	0.16
6-4 TRBZ	6TUR4	400-R-6	3/8	1/4	1.60	0.70	1.31	0.69	1/2	0.19
8-4 TRBZ	8TUR4	400-R-8	1/2	1/4	1.82	0.70	1.53	0.91	9/16	0.19
10-4 TRBZ	10TUR4	400-R-10	5/8	1/4	1.89	0.70	1.60	0.97	11/16	0.19
12-4 TRBZ	12TUR4	400-R-12	3/4	1/4	1.88	0.70	1.59	0.97	13/16	0.19
6-5 TRBZ	6TUR5	500-R-6	3/8	5/16	1.65	0.73	1.36	0.69	9/16	0.25
8-5 TRBZ	8TUR5	500-R-8	1/2	5/16	1.87	0.73	1.58	0.91	9/16	0.25
4-6 TRBZ	4TUR6	600-R-4	1/4	3/8	1.63	0.76	1.34	0.63	5/8	0.19
6-6 TRBZ	6TUR6	600-R-6	3/8	3/8	1.70	0.76	1.41	0.69	5/8	0.28
8-6 TRBZ	8TUR6	600-R-8	1/2	3/8	1.91	0.76	1.62	0.91	5/8	0.28
10-6 TRBZ	10TUR6	600-R-10	5/8	3/8	1.98	0.76	1.69	0.97	11/16	0.28
12-6 TRBZ	12TUR6	600-R-12	3/4	3/8	1.98	0.76	1.69	0.97	13/16	0.28
4-8 TRBZ	4TUR8	810-R-4	1/4	1/2	1.77	0.87	1.37	0.63	13/16	0.19
6-8 TRBZ	6TUR8	810-R-6	3/8	1/2	1.84	0.87	1.44	0.69	13/16	0.19
10-8 TRBZ	10TUR8	810-R-10	5/8	1/2	2.12	0.87	1.72	0.97	13/16	0.41
12-8 TRBZ	12TUR8	810-R-12	3/4	1/2	2.12	0.87	1.72	0.97	13/16	0.41
16-8 TRBZ	16TUR8	810-R-16	1	1/2	2.37	0.87	1.97	1.22	1-1/16	0.41
12-10 TRBZ	12TUR10	1010-R-12	3/4	5/8	2.15	0.87	1.75	0.97	15/16	0.50
14-10 TRBZ	14TUR10	1010-R-14	7/8	5/8	2.21	0.87	1.81	1.03	15/16	0.50
16-10 TRBZ	16TUR10	1010-R-16	1	5/8	2.40	0.87	2.00	1.22	1-1/16	0.50
8-12 TRBZ	8TUR12	1210-R-8	1/2	3/4	2.15	0.87	1.75	0.91	1-1/16	0.39
16-12 TRBZ	16TUR12	1210-R-16	1	3/4	2.46	0.87	2.06	1.22	1-1/16	0.63
24-16 TRBZ†	24TUR16	1610-R-24	1-1/2	1	3.519	1.05	3.03	2.05	1-5/8	0.88
24-20 TRBZ†	24TUR20	2010-R-24	1-1/2	1-1/4	4.10	1.52	3.23	2.05	1-7/8	1.09
32-24 TRBZ†	32TUR24	2410-R-32	2	1-1/2	5.17	1.52	4.10	2.74	2-1/4	1.34

NOTE: A and C dimensions are typical finger-tight.

Dimensions for reference only, subject to change.

Size 1, 2, and 3 do not require a groove.

Size 4 and above tube stub is pre-grooved as standard. Generic (non-grooved) can be ordered through Quick Response Department.

Sizes 20, 24 require additional lubrication prior to assembly.

Add -Z6 for assembly of nuts and ferrules on the tube stub end.

†All tube stubs over 1" come standard with nuts and ferrule(s) pre-assembled (-Z6 option).

Tube End Converter
 For fractional tube to metric tube

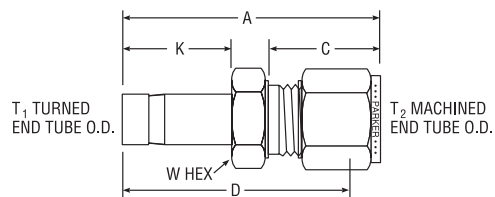
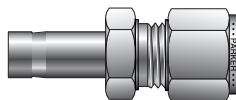

CPI™ PART NO.	A-LOK® PART NO.	INTER- CHANGES WITH	TUBE O. D.		MILLIMETERS					
			T ₁ INCH	T ₂ MM	A	C	D	K	W A/F HEX	BORE
TRBZ 1/8-3	2TUCM3	3MO-R-2	1/8	3	34,3	15,3	27,7	13,5	12,0	1,4
TRBZ 1/4-3	4TUCM3	3MO-R-4	1/4	3	36,1	15,3	29,5	16,0	12,0	4,8
TRBZ 1/4-6	4TUCM6	6MO-R-4	1/4	6	39,3	17,7	31,8	16,0	14,0	4,8
TRBZ 5/16-6	5TUCM6	6MO-R-5	5/16	6	40,0	17,7	32,5	16,8	14,0	6,4
TRBZ 3/8-6	6TUCM6	6MO-R-6	3/8	6	40,8	17,7	33,3	17,5	14,0	7,1
TRBZ 1/2-6	8TUCM6	6MO-R-8	1/2	6	46,4	17,7	38,9	23,1	14,0	9,9
TRBZ 3/8-8	6TUCM8	8MO-R-6	3/8	8	42,0	18,6	34,5	17,5	15,0	7,1
TRBZ 1/2-8	8TUCM8	8MO-R-8	1/2	8	47,5	18,6	40,1	23,1	15,0	9,9
TRBZ 3/8-10	6TUCM10	10MO-R-6	3/8	10	44,4	19,5	36,8	17,5	18,0	7,1
TRBZ 1/2-10	8TUCM10	10MO-R-8	1/2	10	47,6	19,5	41,4	23,1	18,0	9,9
TRBZ 1/2-12	8TUCM12	12MO-R-8	1/2	12	52,3	22,0	42,2	23,1	22,0	9,9
TRBZ 3/4-12	12TUCM12	12MO-R-12	3/4	12	53,8	22,0	43,7	24,6	22,0	15,1
TRBZ 3/4-18	12TUCM18	18MO-R-12	3/4	18	57,5	22,0	47,5	24,6	27,0	15,1

NOTE: A and C dimensions are typical finger-tight.

Dimensions for reference only, subject to change.

Tube stub is pre-grooved as standard. Generic (non-grooved) can be ordered through Quick Response Department.

Size 1, 2, and 3 do not require a groove.

Add -Z6 for assembly of nuts and ferrules on the tube stub end.

Color Coding

For easy reference, table column headings are color indicated as follows:

fractional



metric



Tube End Reducer
 For metric tube

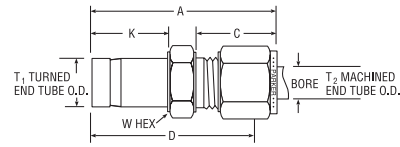
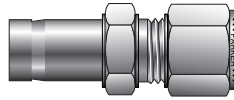

CPI™ PART NO.	A-LOK® PART NO.	INTER- CHANGES WITH	TUBE O.D.		MILLIMETERS							
			T ₁	T ₂	A	C	D	K	O	W HEX	BORE	
TRBZ 3-2	M3TURM2	2MO-R-3M	3	2	34,3	15,3	27,7	13,5	0,6	14,0	1,4	
TRBZ 3-6	M3TURM6	6MO-R-3M	3	6	37,0	17,7	29,5	13,5	0,6	14,0	1,4	
TRBZ 4-3	M4TURM3	3MO-R-4M	4	3	35,0	15,3	28,4	14,3	1,0	12,0	2,0	
TRBZ 6-3	M6TURM3	3MO-R-6M	6	3	36,1	15,3	29,5	15,9	1,0	12,0	2,4	
TRBZ 6-4	M6TURM4	4MO-R-6M	6	4	37,1	16,1	30,5	15,9	1,0	12,0	3,0	
TRBZ 6-8	M6TURM8	8MO-R-6M	6	8	40,0	18,6	32,5	15,9	1,0	15,0	4,0	
TRBZ 6-10	M6TURM10	10MO-R-6M	6	10	41,7	19,5	34,1	15,9	1,0	18,0	4,0	
TRBZ 6-12	M6TURM12	12MO-R-6M	6	12	44,9	22,0	34,8	15,9	1,0	22,0	4,0	
TRBZ 8-6	M8TURM6	6MO-R-8M	8	6	40,0	17,7	32,5	16,7	0,8	14,0	4,8	
TRBZ 8-10	M8TURM10	10MO-R-8M	8	10	43,4	19,5	35,8	15,3	1,5	19,5	18,0	
TRBZ 10-3	M10TURM3	3MO-R-10M	10	3	38,6	15,3	32,0	17,7	2,0	15,3	12,0	
TRBZ 10-6	M10TURM6	6MO-R-10M	10	6	40,8	17,7	33,3	17,5	1,3	14,0	4,8	
TRBZ 10-8	M10TURM8	8MO-R-10M	10	8	42,0	18,6	34,5	17,5	1,3	15,0	6,4	
TRBZ 10-12	M10TURM12	12MO-R-10M	10	12	46,6	22,0	36,5	17,5	1,3	22,0	7,5	
TRBZ 12-6	M12TURM6	6MO-R-12M	12	6	46,4	17,7	38,9	23,0	1,4	14,0	4,8	
TRBZ 12-8	M12TURM8	8MO-R-12M	12	8	47,6	18,6	40,1	23,0	1,4	15,0	6,4	
TRBZ 12-10	M12TURM10	10MO-R-12M	12	10	49,7	19,5	42,1	23,0	1,4	18,0	7,9	
TRBZ 12-16	M12TURM16	16MO-R-12M	12	16	53,0	22,0	42,9	23,0	1,4	24,0	9,1	
TRBZ 12-18	M12TURM18	18MO-R-12M	12	18	54,6	22,0	44,5	23,0	1,4	27,0	9,1	
TRBZ 15-10	M15TURM10	10MO-R-15M	15	10	51,3	19,5	43,7	23,8	1,6	27,0	7,9	
TRBZ 16-12	M16TURM12	12MO-R-16M	16	12	53,8	22,0	43,7	24,6	1,7	22,0	9,5	
TRBZ 16-18	M16TURM18	18MO-R-16M	16	18	56,1	22,0	46,0	24,6	1,7	27,0	12,7	
TRBZ 16-20	M16TURM20	20MO-R-16M	16	20	57,9	22,0	47,8	24,6	1,7	27,0	12,7	
TRBZ 16-25	M16TURM25	25MO-R-16M	16	25	63,2	26,5	51,0	24,8	2,0	26,5	35,0	
TRBZ 18-12	M18TURM12	12MO-R-18M	18	12	53,8	22,0	43,7	24,6	2,0	22,0	9,5	
TRBZ 18-16	M18TURM16	16MO-R-18M	18	16	54,7	22,0	44,6	24,8	2,5	22,0	24,0	
TRBZ 18-20	M18TURM20	20MO-R-18M	18	20	57,9	22,0	47,8	24,6	2,0	30,0	13,9	
TRBZ 18-25	M18TURM25	25MO-R-18M	18	25	63,1	26,5	50,8	24,6	2,0	35,0	14,0	
TRBZ 20-12	M20TURM12	12MO-R-20M	20	12	56,1	22,0	46,0	25,4	2,5	22,0	9,5	
TRBZ 20-16	M20TURM16	16MO-R-20M	20	16	55,3	22,0	45,2	25,6	2,5	22,0	24,0	
TRBZ 20-18	M20TURM18	18MO-R-20M	20	18	57,6	22,0	47,5	25,4	2,5	27,0	15,1	
TRBZ 20-25	M20TURM25	25MO-R-20M	20	25	64,5	26,5	52,3	25,4	2,5	35,0	15,1	
TRBZ 22-18	M22TURM18	18MO-R-22M	22	18	56,1	22,0	46,0	26,2	2,5	27,0	15,1	
TRBZ 22-20	M22TURM20	20MO-R-22M	22	20	57,7	22,0	47,6	26,2	2,5	30,0	15,8	
TRBZ 25-12	M25TURM12	12MO-R-25M	25	12	60,9	22,0	50,8	31,8	2,6	27,0	9,5	
TRBZ 25-16	M25TURM16	16MO-R-25M	25	16	64,0	22,0	51,8	32,0	3,0	22,0	27,0	
TRBZ 25-18	M25TURM18	18MO-R-25M	25	18	62,5	22,0	52,4	31,8	2,6	27,0	15,1	
TRBZ 25-20	M25TURM20	20MO-R-25M	25	20	64,2	22,0	54,1	31,8	2,6	30,0	15,8	

NOTE: A and C dimensions are typical finger-tight.

Dimensions for reference only, subject to change.

Tube stub is pre-grooved as standard.
 Add -Z6 for assembly of nuts and ferrules on the tube stub end.

Color Coding

For easy reference, table column headings are color indicated as follows:

fractional



metric



Tube End Bulkhead Adapter
 For fractional tube

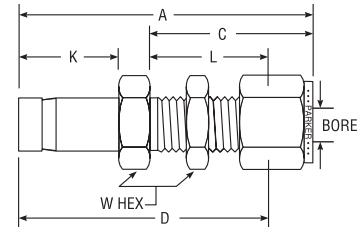
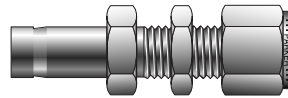

CPI™ PART NO.	A-LOK® PART NO.	INTER- CHANGES WITH	INCHES							
			TUBE O. D.	A	C	L	K	D	BORE	W HEX
2-2 T2H2BZ	2TUBC2	200-R1-2	1/8	1.95	1.23	0.97	.53	1.69	.093	1/2
4-4 T2H2BZ	4TUBC4	400-R1-4	1/4	2.20	1.31	1.02	.63	1.91	.187	5/8
6-6 T2H2BZ	6TUBC6	600-R1-6	3/8	2.42	1.44	1.16	.69	2.13	.281	3/4
8-8 T2H2BZ	8TUBC8	810-R1-8	1/2	2.87	1.65	1.25	.91	2.47	.406	15/16

NOTE: A and C dimensions are typical finger-tight.

Dimensions for reference only, subject to change.

Tube stub is pre-grooved as standard. Generic (non-grooved) can be ordered through Quick Response Department.
 Add -Z6 for assembly of nuts and ferrules on the tube stub end.

Port Connector
 For fractional tube

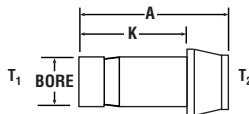
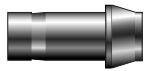

CPI™ PART NO.	A-LOK® PART NO.	INTER- CHANGES WITH	INCHES			
			TUBE O. D.	A	K	BORE
1-1 ZPC	1PC1	101-PC	1/16	0.63	0.44	.031
1-2 ZPC	1PC2	201-PC-1	1/16-1/8	0.84	0.44	.031
1-4 ZPC	1PC4	401-PC-1	1/16-1/4	0.91	0.44	.031
2-2 ZPC	2PC2	201-PC	1/8	0.95	0.54	.078
2-4 ZPC	2PC4	401-PC-2	1/8-1/4	1.05	0.54	.078
2-6 ZPC	2PC6	601-PC-2	1/8-3/8	1.09	0.54	.031
3-3 ZPC	3PC3	301-PC	3/16	0.98	0.67	.116
4-4 ZPC	4PC4	401-PC	1/4	1.07	0.76	.156
4-6 ZPC	4PC6	601-PC-4	1/4-3/8	1.15	0.64	.156
4-8 ZPC	4PC8	811-PC-4	1/4-1/2	1.36	0.64	.156
6-6 ZPC	6PC6	601-PC	3/8	1.16	0.84	.281
6-8 ZPC	6PC8	811-PC-6	3/8-1/2	1.40	0.72	.281
8-8 ZPC	8PC8	811-PC	1/2	1.59	1.11	.375
8-12 ZPC	8PC12	1211-PC-8	1/2-3/4	1.72	0.91	.375
12-12 ZPC	12PC12	1211-PC	3/4	1.65	1.16	.578
16-16 ZPC	16PC16	1611-PC	1	2.12	1.44	.813

Dimensions for reference only, subject to change.

NOTE: Tube stub is pre-grooved as standard. (Size 1, 2, and 3 not grooved). Generic (non-grooved 4-16) can be ordered through Quick Response Department.

The machined ferrule end (T₂) requires only 1/4 turn from finger tight to assemble.
 Add -Z6 for assembly of nuts and ferrules on the tube stub end.

Port Connector
 For metric tube

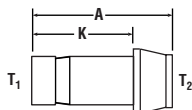

CPI™ PART NO.	A-LOK® PART NO.	INTER- CHANGES WITH	MILLIMETERS				
			TUBE O. D.		A	K	BORE
			T ₁	T ₂			
ZPC 3-3	PCM3	3M1-PC	3	3	22,2	15,7	1,6
ZPC 6-6	PCM6	6M1-PC	6	6	24,6	18,7	3,0
ZPC 8-8	PCM8	8M1-PC	8	8	25,9	20,0	5,0
ZPC 10-10	PCM10	10M1-PC	10	10	26,1	20,2	6,0
ZPC 12-12	PCM12	12M1-PC	12	12	35,8	26,0	8,0
ZPC 16-16	PCM16	16M1-PC	16	16	40,5	27,7	12,0
ZPC 18-18	PCM18	18M1-PC	18	18	40,8	27,7	13,0
ZPC 3-6	M3PCM6	6M1-PC-3M	3	6	22,6	13,5	1,6
ZPC 6-8	M6PCM8	8M1-PC-6M	6	8	25,5	16,1	3,0
ZPC 6-10	M6PCM10	10M1-PC-6M	6	10	25,5	16,1	3,0
ZPC 6-12	M6PCM12	12M1-PC-6M	6	12	31,2	16,1	3,0
ZPC 8-10	M8PCM10	10M1-PC-8M	8	10	29,5	16,8	5,0
ZPC 8-12	M8PCM12	12M1-PC-8M	8	12	31,4	16,8	5,0

Dimensions for reference only, subject to change.

NOTE: Tube stub is pre-grooved as standard. (Size M2, M3, and M4 not grooved).

The machined ferrule end (T₂) requires only 1/4 turn from finger tight to assemble.
 Add -Z6 for assembly of nuts and ferrules on the tube stub end.

**NPT Tube End
Male Adapter**
For fractional tube

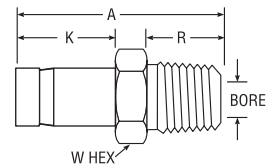
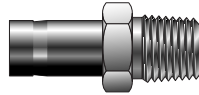

CPI™ PART NO.	A-LOK® PART NO.	INTER- CHANGES WITH	INCHES						
			TUBE O.D.	NPT PIPE THREAD	A	R	K	W HEX	BORE
1-2 T2HF	1MA2N	1-TA-1-1	1/16	1/8	1.00	0.38	0.38	7/16	.031
2-2 T2HF	2MA2N	2-TA-1-2	1/8	1/8	1.16	0.38	0.54	7/16	.078
2-4 T2HF	2MA4N	2-TA-1-4	1/8	1/4	1.38	0.56	0.54	9/16	.078
3-2 T2HF	3MA2N	3-TA-1-2	3/16	1/8	1.20	0.38	0.58	7/16	.116
3-4 T2HF	3MA4N	3-TA-1-4	3/16	1/4	1.42	0.56	0.58	9/16	.116
4-2 T2HF	4MA2N	4-TA-1-2	1/4	1/8	1.25	0.38	0.63	7/16	.156
4-4 T2HF	4MA4N	4-TA-1-4	1/4	1/4	1.46	0.56	0.63	9/16	.156
4-6 T2HF	4MA6N	4-TA-1-6	1/4	3/8	1.49	0.56	0.63	11/16	.156
4-8 T2HF	4MA8N	4-TA-1-8	1/4	1/2	1.71	0.75	0.63	7/8	.156
5-2 T2HF	5MA2N	5-TA-1-2	5/16	1/8	1.29	0.38	0.66	7/16	.219
5-4 T2HF	5MA4N	5-TA-1-4	5/16	1/4	1.50	0.56	0.66	9/16	.219
5-6 T2HF	5MA6N	5-TA-1-6	5/16	3/8	1.53	0.56	0.66	11/16	.219
5-8 T2HF	5MA8N	5-TA-1-8	5/16	1/2	1.74	0.75	0.66	7/8	.219
6-2 T2HF	6MA2N	6-TA-1-2	3/8	1/8	1.32	0.38	0.69	7/16	.281
6-4 T2HF	6MA4N	6-TA-1-4	3/8	1/4	1.53	0.56	0.69	9/16	.281
6-6 T2HF	6MA6N	6-TA-1-6	3/8	3/8	1.56	0.56	0.69	11/16	.281
6-8 T2HF	6MA8N	6-TA-1-8	3/8	1/2	1.78	0.75	0.69	7/8	.281
8-4 T2HF	8MA4N	8-TA-1-4	1/2	1/4	1.75	0.56	0.91	9/16	.281
8-6 T2HF	8MA6N	8-TA-1-6	1/2	3/8	1.78	0.56	0.91	11/16	.375
8-8 T2HF	8MA8N	8-TA-1-8	1/2	1/2	2.00	0.75	0.91	7/8	.375
10-8 T2HF	10MA8N	10-TA-1-8	5/8	1/2	2.06	0.75	0.97	7/8	.469
12-8 T2HF	12MA8N	12-TA-1-8	3/4	1/2	2.06	0.75	0.97	7/8	.469
12-12 T2HF	12MA12N	12-TA-1-12	3/4	3/4	2.06	0.75	0.97	1-1/16	.578
12-16 T2HF	12MA16N	12-TA-1-16	3/4	1	2.41	0.94	0.97	1-3/8	.813
16-12 T2HF	16MA12N	16-TA-1-12	1	3/4	2.31	0.75	1.22	1-1/16	.813
16-16 T2HF	16MA16N	16-TA-1-16	1	1	2.68	0.94	1.22	1-3/8	.813
20-20 T2HF	20MA20N	20-TA-1-20	1-1/4	1-1/4	3.16	0.97	1.71	1-3/4	1.000
24-24 T2HF	24MA24N	24-TA-1-24	1-1/2	1-1/2	3.72	1.00	2.05	2-1/8	1.250
32-32 T2HF	32MA32N	32-TA-1-32	2	2	4.70	1.04	2.74	2-3/4	1.720

NOTE: Add -Z6 for assembly of nuts and ferrules on the tube stub end.

Dimensions for reference only, subject to change.

Tube stub is pre-grooved as standard. Generic (non-grooved) can be ordered through Quick Response Department.

Inch sizes 1, 2, and 3 and metric sizes 2, 3, and 4mm do not have grooves.

Sizes 20, 24, 32 require additional lubrication prior to assembly.

**BSPP Tube End
Male Adapter**
For fractional tube

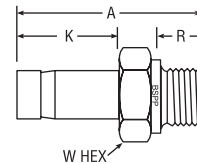
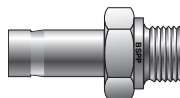

CPI™ PART NO.	A-LOK® PART NO.	INTER- CHANGES WITH	INCHES						
			TUBE O.D.	BSPP THREAD	A	K	R	W HEX	BORE
2-2R T2HF	2MA2R	2TA-1-2RS	1/8	1/8	1.09	0.53	.28	9/16	.05
2-4R T2HF	2MA4R	2TA-1-4RS	1/8	1/4	1.31	0.53	.44	3/4	.05
4-2R T2HF	4MA2R	4TA-1-2RS	1/4	1/8	1.19	0.63	.28	9/16	.16
4-4R T2HF	4MA4R	4TA-1-4RS	1/4	1/4	1.50	0.63	.44	3/4	.18
6-2R T2HF	6MA2R	6TA-1-2RS	3/8	1/8	1.34	0.69	.28	3/4	.05
6-4R T2HF	6MA4R	6TA-1-4RS	3/8	1/4	1.47	0.69	.44	3/4	.25
6-6R T2HF	6MA6R	6TA-1-6RS	3/8	3/8	1.50	0.69	.44	7/8	.28
6-8R T2HF	6MA8R	6TA-1-8RS	3/8	1/2	1.69	0.69	.56	1-1/16	.28
8-4R T2HF	8MA4R	8TA-1-4RS	1/2	1/4	1.69	0.91	.44	3/4	.25
8-6R T2HF	8MA6R	8TA-1-6RS	1/2	3/8	1.72	0.91	.44	7/8	.31
8-8R T2HF	8MA8R	8TA-1-8RS	1/2	1/2	1.94	0.91	.56	1-1/16	.39
10-8R T2HF	10MA8R	10TA-1-8RS	5/8	1/2	1.97	0.97	.56	1-1/16	.47
12-12R T2HF	12MA12R	12TA-1-12RS	3/4	3/4	2.09	0.97	.63	1-5/16	.578
16-16R T2HF	16MA16R	16TA-1-16RS	1	1	2.53	1.22	.72	1-5/8	.80

NOTE: Add -Z6 for assembly of nuts and ferrules on the tube stub end.

Dimensions for reference only, subject to change.

Tube stub is pre-grooved as standard. Generic (non-grooved) can be ordered through Quick Response Department.

Bonded sealing washer must be used with this design, see page 76.

BSPP Tube End Male Adapter For metric tube

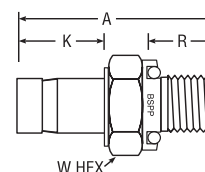
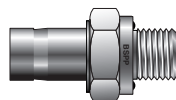

CPI™ PART NO.	A-LOK® PART NO.	INTER- CHANGES WITH	MILLIMETERS								
			TUBE O. D.	BSPP THREAD	A	K	Q	R	X	W HEX	BORE
T2HF 3-1/8R	M3MA1/8R	3-MTA-1-2RS	3	1/8	31,0	13,5	0,6	7,1	13,7	14,0	1,8
T2HF 4-1/8R	M4MA1/8R	4-MTA-1-2RS	4	1/8	31,8	14,3	1,0	7,1	13,7	14,0	2,0
T2HF 6-1/8R	M6MA1/8R	6-MTA-1-2RS	6	1/8	33,3	15,9	1,0	7,1	13,7	14,0	4,0
T2HF 6-1/4R	M6MA1/4R	6-MTA-1-4RS	6	1/4	38,1	15,9	1,0	11,2	17,8	19,0	4,0
T2HF 8-1/4R	M8MA1/4R	8-MTA-1-4RS	8	1/4	38,9	16,7	0,8	11,2	17,8	19,0	6,4
T2HF 10-1/4R	M10MA1/4R	10-MTA-1-4RS	10	1/4	39,7	17,5	1,3	11,2	17,8	19,0	6,4
T2HF 10-3/8R	M10MA3/8R	10-MTA-1-6RS	10	3/8	38,9	17,5	1,3	11,2	21,8	22,0	7,5
T2HF 10-1/2R	M10MA1/2R	10-MTA-1-8RS	10	1/2	42,9	17,5	1,3	14,2	25,7	27,0	7,5
T2HF 12-1/4R	M12MA1/4R	12-MTA-1-4RS	12	1/4	43,7	23,0	1,4	11,2	17,8	19,0	6,4
T2HF 12-3/8R	M12MA3/8R	12-MTA-1-6RS	12	3/8	44,5	23,0	1,4	11,2	21,8	22,0	7,9
T2HF 12-1/2R	M12MA1/2R	12-MTA-1-8RS	12	1/2	49,2	23,0	1,4	14,2	25,7	27,0	9,1
T2HF 16-1/2R	M16MA1/2R	16-MTA-1-8RS	16	1/2	50,8	24,6	1,7	14,2	25,7	27,0	11,9
T2HF 18-3/4R	M18MA3/4R	18-MTA-1-12RS	18	3/4	53,2	24,6	2,0	16,0	31,8	33,0	14,0
T2HF 20-3/4R	M20MA3/4R	20-MTA-1-12RS	20	3/4	54,0	25,4	2,5	16,0	31,8	33,0	15,1
T2HF 25-1R	M25MA1R	25-MTA-1-16RS	25	1	65,1	31,8	2,6	18,3	38,6	41,0	19,8

Dimensions for reference only, subject to change.

NOTE: Tube stub is pre-grooved as standard. Generic (non-grooved) can be ordered through Quick Response Department.

Bonded sealing washer must be used with this design, see page 76.

Add -Z6 for assembly of nuts and ferrules on the tube stub end.

BSPP Tube End Male Adapter with ED Seal For fractional tube

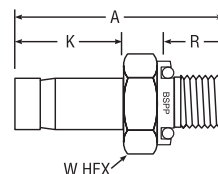
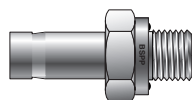

CPI™ PART NO.	A-LOK® PART NO.	INTER- CHANGES WITH	INCHES							
			TUBE O. D.	BSPP THREAD	A	K	R	X	W HEX	BORE
4-4R-ED T2HF	4MA4R-ED	—	1/4	1/4	1.50	.63	.47	0.74	3/4	.18
4-6R-ED T2HF	4MA6R-ED	—	1/4	3/8	1.50	.63	.47	0.86	3/4	.18
8-4R-ED T2HF	8MA4R-ED	—	1/2	1/4	1.75	.91	.47	0.74	3/4	.25
8-6R-ED T2HF	8MA6R-ED	—	1/2	3/8	1.78	.91	.47	0.86	7/8	.31
8-8R-ED T2HF	8MA8R-ED	—	1/2	1/2	1.94	.91	.55	1.04	1-1/16	.39

Dimensions for reference only, subject to change.

NOTE: Tube stub is pre-grooved as standard. Generic (non-grooved) can be ordered through Quick Response Department.

ED fittings are supplied with sealing washers in nitrile as standard, suitable for temperatures between -35°C and +100°C (-31°F to +212°F). Fluorocarbon seals are available upon request which are suitable for temperatures between -25°C and +120°C (-13°F to +248°F).

Add -Z6 for assembly of nuts and ferrules on the tube stub end.

Color Coding

For easy reference, table column headings are color indicated as follows:

fractional



metric



BSPP Tube End Male Adapter with ED Seal

For metric tube

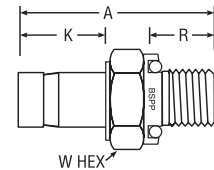
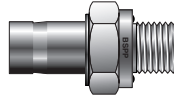

CPI™ PART NO.	A-LOK® PART NO.	INTER- CHANGES WITH	MILLIMETERS						
			TUBE O.D.	BSPP THREAD	A	K	R	W HEX	BORE
T2HF 6-1/4R-ED	M6MA1/4R-ED	—	6	1/4	36,6	15,9	7,9	19,0	4,0
T2HF 6-1/2R-ED	M6MA1/2R-ED	—	6	1/2	42,7	15,9	14,0	27,0	4,0
T2HF 10-1/4R-ED	M10MA1/4R-ED	—	10	1/4	38,1	17,5	11,9	19,0	6,4
T2HF 10-1/2R-ED	M10MA1/2R-ED	—	10	1/2	44,2	17,5	14,0	27,0	7,5
T2HF 12-1/4R-ED	M12MA1/4R-ED	—	12	1/4	43,7	23,0	11,9	19,0	6,4
T2HF 12-3/8R-ED	M12MA3/8R-ED	—	12	3/8	45,0	23,0	11,9	22,0	7,9
T2HF 12-1/2R-ED	M12MA1/2R-ED	—	12	1/2	49,8	23,0	14,0	27,0	9,1

Dimensions for reference only, subject to change.

NOTE: Tube stub is pre-grooved as standard. Generic (non-grooved) can be ordered through Quick Response Department.

ED fittings are supplied with sealing washers in nitrile as standard, suitable for temperatures between -35°C and +100°C (-31°F to +212°F). Fluorocarbon seals are available upon request which are suitable for temperatures between -25°C and +120°C (-13°F to +248°F). Add -Z6 for assembly of nuts and ferrules on the tube stub end.

NPT Male Adapter

For metric tube

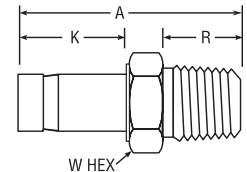
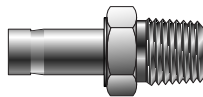

CPI™ PART NO.	A-LOK® PART NO.	INTER- CHANGES WITH	MILLIMETERS						
			TUBE O.D.	NPT THREAD	A	K	R	W HEX	BORE
T2HF 3-1/8	M3MA1/8N	3-MTA-1-2	3	1/8	29,4	13,5	9,7	12,0	1,8
T2HF 4-1/8	M4MA1/8N	4-MTA-1-2	4	1/8	29,4	14,3	9,7	12,0	2,0
T2HF 6-1/8	M6MA1/8N	6-MTA-1-2	6	1/8	31,0	15,9	9,7	12,0	4,0
T2HF 6-1/4	M6MA1/4N	6-MTA-1-4	6	1/4	35,7	15,9	14,2	14,0	4,0
T2HF 6-3/8	M6MA3/8N	6-MTA-1-6	6	3/8	36,5	16,1	14,2	18,0	3,0
T2HF 6-1/2	M6MA1/2N	6-MTA-1-8	6	1/2	42,1	16,1	19,1	22,0	3,0
T2HF 8-1/4	M8MA1/4N	8-MTA-1-4	8	1/4	37,3	16,7	14,2	14,0	6,4
T2HF 8-3/8	M8MA3/8N	8-MTA-1-6	8	3/8	38,1	16,7	14,2	12,0	6,4
T2HF 10-1/4	M10MA1/4N	10-MTA-1-4	10	1/4	38,1	17,5	14,2	14,0	7,1
T2HF 10-3/8	M10MA3/8N	10-MTA-1-6	10	3/8	43,7	17,5	14,2	18,0	7,5
T2HF 10-1/2	M10MA1/2N	10-MTA-1-8	10	1/2	44,5	17,5	19,1	22,0	7,5
T2HF 12-1/4	M12MA1/4N	12-MTA-1-4	12	1/4	43,7	23,0	14,2	14,0	7,1
T2HF 12-3/8	M12MA3/8N	12-MTA-1-6	12	3/8	44,5	23,0	14,2	27,0	9,1
T2HF 12-1/2	M12MA1/2N	12-MTA-1-8	12	1/2	49,2	23,0	19,1	22,0	9,1
T2HF 16-1/2	M16MA1/2N	16-MTA-1-8	16	1/2	50,8	24,6	19,1	22,0	12,7
T2HF 16-3/4	M16MA3/4N	16-MTA-1-12	16	3/4	51,6	24,6	19,1	27,0	12,7
T2HF 18-1/2	M18MA1/2N	18-MTA-1-8	18	1/2	50,8	24,6	19,1	22,0	12,7
T2HF 18-3/4	M18MA3/4N	18-MTA-1-12	18	3/4	51,6	24,6	19,1	27,0	14,0
T2HF 20-1/2	M20MA1/2N	20-MTA-1-8	20	1/2	51,8	25,6	19,1	22,0	15,0
T2HF 20-3/4	M20MA3/4N	20-MTA-1-12	20	3/4	52,4	25,4	19,1	27,0	15,1
T2HF 25-1	M25MA1N	25-MTA-1-16	25	1	65,9	31,8	23,9	35,0	19,8

Dimensions for reference only, subject to change.

NOTE: Tube stub is pre-grooved as standard. Generic (non-grooved) can be ordered through Quick Response Department.

Add -Z6 for assembly of nuts and ferrules on the tube stub end.

Color Coding

For easy reference, table column headings are color indicated as follows:

fractional



metric



BSP Taper Male Adapter For fractional tube

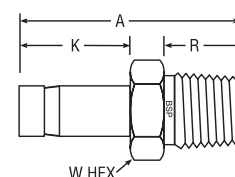
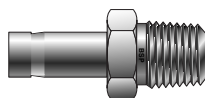

CPI™ PART NO.	A-LOK® PART NO.	INTER- CHANGES WITH	INCHES						
			TUBE O.D.	BSPT THREAD	A	K	R	W HEX	BORE
4-2K T2HFK	4MA2K	4-TA-1-2RT	1/4	1/8	1.25	.63	.38	7/16	.156
4-4K T2HFK	4MA4K	4-TA-1-4RT	1/4	1/4	1.46	.63	.56	9/16	.156
4-6K T2HFK	4MA6K	4-TA-1-6RT	1/4	3/8	1.44	.63	.56	11/16	.156
4-8K T2HFK	4MA8K	4-TA-1-8RT	1/4	1/2	1.66	.63	.75	7/8	.219
5-2 T2HFK	5MA2K	5-TA-1-2RT	5/16	1/8	1.29	.66	.38	7/16	.219
5-4 T2HFK	5MA4K	5-TA-1-4RT	5/16	1/4	1.50	.66	.56	9/16	.219
6-4 T2HFK	6MA4K	6-TA-1-4RT	3/8	1/4	1.50	.69	.56	9/16	.281
6-6 T2HFK	6MA6K	6-TA-1-6RT	3/8	3/8	1.50	.69	.56	11/16	.281
6-8 T2HFK	6MA8K	6-TA-1-8RT	3/8	1/2	1.72	.69	.75	7/8	.281
8-4 T2HFK	8MA4K	8-TA-1-4RT	1/2	1/4	1.72	.91	.56	9/16	.375
8-6 T2HFK	8MA6K	8-TA-1-6RT	1/2	3/8	1.75	.91	.56	11/16	.375
8-8 T2HFK	8MA8K	8-TA-1-8RT	1/2	1/2	1.94	.91	.75	7/8	.375
10-8 T2HFK	10MA8K	10-TA-1-8RT	5/8	1/2	2.06	.97	.75	7/8	.469

Dimensions for reference only, subject to change.

NOTE: Tube stub is pre-grooved as standard. Generic (non-grooved) can be ordered through Quick Response Department.

Add -Z6 for assembly of nuts and ferrules on the tube stub end.

BSP Taper Male Adapter For metric tube

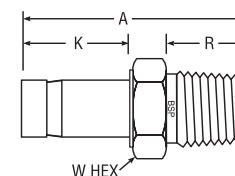
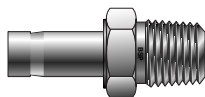

CPI™ PART NO.	A-LOK® PART NO.	INTER- CHANGES WITH	MILLIMETERS						
			TUBE O.D.	BSPT THREAD	A	K	R	W HEX	BORE
T2HF 3-1/8K	M3MA1/8K	3-MTA-1-2RT	3	1/8	29,4	13,5	9,7	12,0	1,8
T2HF 4-1/8K	M4MA1/8K	4-MTA-1-2RT	4	1/8	29,4	14,3	9,7	12,0	2,0
T2HF 6-1/8K	M6MA1/8K	6-MTA-1-2RT	6	1/8	31,0	15,9	9,7	12,0	4,0
T2HF 6-1/4K	M6MA1/4K	6-MTA-1-4RT	6	1/4	35,7	15,9	14,2	14,0	4,0
T2HF 8-1/4K	M8MA1/4K	8-MTA-1-4RT	8	1/4	37,3	16,7	14,2	14,0	6,4
T2HF 8-3/8K	M8MA3/8K	8-MTA-1-6RT	8	3/8	38,3	16,8	14,2	18,0	5,0
T2HF 10-1/4K	M10MA1/4K	10-MTA-1-4RT	10	1/4	38,1	17,5	14,2	14,0	7,1
T2HF 10-3/8K	M10MA3/8K	10-MTA-1-6RT	10	3/8	38,1	17,5	14,2	18,0	7,5
T2HF 10-1/2K	M10MA1/2K	10-MTA-1-8RT	10	1/2	44,5	17,5	19,1	22,0	7,5
T2HF 12-1/4K	M12MA1/4K	12-MTA-1-4RT	12	1/4	43,7	23,0	14,2	14,0	7,1
T2HF 12-3/8K	M12MA3/8K	12-MTA-1-6RT	12	3/8	44,5	23,0	14,2	18,0	9,1
T2HF 12-1/2K	M12MA1/2K	12-MTA-1-8RT	12	1/2	49,2	23,0	19,1	22,0	9,1
T2HF 16-1/2K	M16MA1/2K	16-MTA-1-8RT	16	1/2	50,8	24,6	19,1	22,0	12,7
T2HF 18-3/4K	M18MA3/4K	18-MTA-1-12RT	18	3/4	51,6	24,6	19,1	27,0	14,0
T2HF 20-3/4K	M20MA3/4K	20-MTA-1-12RT	20	3/4	52,4	25,4	19,1	27,0	15,1
T2H 25-1K	M25MA1K	25-MTA-1-16RT	25	1	65,9	31,8	23,9	35,0	19,8

Dimensions for reference only, subject to change.

NOTE: Tube stub is pre-grooved as standard. Generic (non-grooved) can be ordered through Quick Response Department.

Add -Z6 for assembly of nuts and ferrules on the tube stub end.

Tube End to SAE Straight Thread Adapter For fractional tube

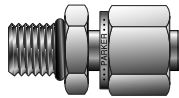
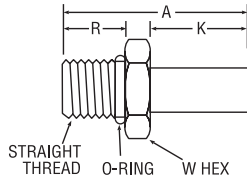
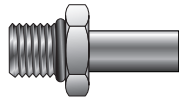

CPI™ PART NO.	A-LOK® PART NO.	INTER- CHANGES WITH	INCHES						O-RING APR UNIFORM DASH NO.
			T TUBE O.D.	STRAIGHT THREAD SIZE	A	K	R	W HEX	
6-4 T2HOA	6TUHOA4	6-TA-1-4ST	3/8	7/16-20	1.46	0.69	.36	9/16	3-904
6-8 T2HOA	6TUHOA8	6-TA-1-8ST	3/8	3/4-16	1.59	0.69	.44	7/8	3-908
8-6 T2HOA	8TUHOA6	8-TA-1-6ST	1/2	9/16-18	1.74	0.91	.39	11/16	3-906
10-10 T2HOA	10TUHOA10	10-TA-1-10ST	5/8	7/8-14	1.94	0.91	.50	1	3-910
*24-24 T2HOA	24TUHOA24	24-TA-1-24ST	1-1/2	1-7/8-12	3.28	2.05	.59	2-1/8	3-924

* Size 24 is preassembled with nut and ferrules.

Dimensions for reference only, subject to change.

A dimension is typical finger-tight.

Size 24 requires additional lubrication prior to assembly.

Parts are supplied with nitrile o-rings as standard. For Fluorocarbon o-rings, add the suffix "-VO".

Other o-rings available upon request.

Add -Z6 for assembly of nuts and ferrules
on the tube stub end.

Tube End NPT Female Adapter For fractional tube

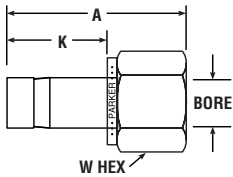
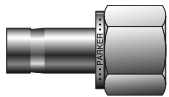

CPI™ PART NO.	A-LOK® PART NO.	INTER- CHANGES WITH	INCHES					
			TUBE O.D.	NPT PIPE THREAD	A	K	W HEX	BORE
1-2 T2HG	1FA2N	1-TA-7-2	1/16	1/8	1.07	0.34	9/16	.031
2-2 T2HG	2FA2N	2-TA-7-2	1/8	1/8	1.23	0.53	9/16	.093
2-4 T2HG	2FA4N	2-TA-7-4	1/8	1/4	1.38	0.53	3/4	.093
3-2 T2HG	3FA2N	3-TA-7-2	3/16	1/8	1.25	0.56	9/16	.116
3-4 T2HG	3FA4N	3-TA-7-4	3/16	1/4	1.42	0.56	3/4	.116
4-2 T2HG	4FA2N	4-TA-7-2	1/4	1/8	1.31	0.63	9/16	.188
4-4 T2HG	4FA4N	4-TA-7-4	1/4	1/4	1.47	0.63	3/4	.188
4-6 T2HG	4FA6N	4-TA-7-6	1/4	3/8	1.56	0.63	7/8	.188
4-8 T2HG	4FA8N	4-TA-7-8	1/4	1/2	1.80	0.63	1-1/16	.188
5-2 T2HG	5FA2N	5-TA-7-2	5/16	1/8	1.34	0.66	9/16	.219
5-4 T2HG	5FA4N	5-TA-7-4	5/16	1/4	1.50	0.66	3/4	.219
5-6 T2HG	5FA6N	5-TA-7-6	5/16	3/8	1.59	0.66	7/8	.219
6-2 T2HG	6FA2N	6-TA-7-2	3/8	1/8	1.36	0.69	9/16	.281
6-4 T2HG	6FA4N	6-TA-7-4	3/8	1/4	1.55	0.69	3/4	.281
6-6 T2HG	6FA6N	6-TA-7-6	3/8	3/8	1.59	0.69	7/8	.281
6-8 T2HG	6FA8N	6-TA-7-8	3/8	1/2	1.84	0.69	1-1/16	.281
8-4 T2HG	8FA4N	8-TA-7-4	1/2	1/4	1.72	0.91	3/4	.391
8-6 T2HG	8FA6N	8-TA-7-6	1/2	3/8	1.80	0.91	7/8	.391
8-8 T2HG	8FA8N	8-TA-7-8	1/2	1/2	2.10	0.91	1-1/16	.390
10-6 T2HG	10FA6N	10-TA-7-6	5/8	3/8	1.86	0.97	7/8	.469
10-8 T2HG	10FA8N	10-TA-7-8	5/8	1/2	2.09	0.97	1-1/16	.469
12-8 T2HG	12FA8N	12-TA-7-8	3/4	1/2	2.10	0.97	1-1/16	.578
12-12 T2HG	12FA12N	12-TA-7-12	3/4	3/4	2.16	0.97	1-1/4	.578
12-16 T2HG	12FA16N	12-TA-7-16	3/4	1	2.30	0.97	1-5/8	.578
14-12 T2HG	14FA12N	14-TA-7-12	7/8	3/4	2.22	1.02	1-5/16	.578
16-12 T2HG	16FA12N	16-TA-7-12	1	3/4	2.41	1.22	1-5/16	.813
16-16 T2HG	16FA16N	16-TA-7-16	1	1	2.54	1.22	1-5/8	.813
20-20 T2HG	20FA20N	20-TA-7-20	1-1/4	1-1/4	3.06	1.71	2-1/8	1.000
24-24 T2HG	24FA24N	24-TA-7-24	1-1/2	1-1/2	3.50	2.05	2-3/8	1.250
32-32 T2HG	32FA32N	32-TA-7-32	2	2	4.23	2.74	2-7/8	1.720

NOTE: Tube stub is pre-grooved as standard.

Dimensions for reference only, subject to change.

Generic (non-grooved) can be ordered through Quick Response Department.

Add -Z6 for assembly of nuts and ferrules on the tube stub end.

Color Coding

For easy reference, table column headings are color indicated as follows:

fractional

metric



Tube End NPT Female Adapter For metric tube

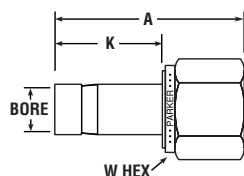
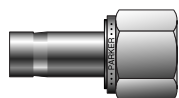

CPI™ PART NO.	A-LOK® PART NO.	INTER- CHANGES WITH	MILLIMETERS					
			TUBE O. D.	NPT THREAD	A	K	W HEX	BORE
T2HG 3-1/8	M3FA1/8N	3-MTA-7-2	3	1/8	31,3	13,5	14,0	1,3
T2HG 4-1/8	M4FA1/8N	4-MTA-7-2	4	1/8	29,4	14,3	14,0	2,0
T2HG 6-1/8	M6FA1/8N	6-MTA-7-2	6	1/8	29,4	15,9	14,0	4,0
T2HG 6-1/4	M6FA1/4N	6-MTA-7-4	6	1/4	34,1	15,9	19,0	4,0
T2HG 8-1/8	M8FA1/8N	8-MTA-7-2	8	1/8	35,5	16,7	14,0	6,4
T2HG 8-1/4	M8FA1/4N	8-MTA-7-4	8	1/4	35,1	16,7	19,0	6,4
T2HG 8-3/8	M8FA3/8N	8-MTA-7-6	8	3/8	36,5	16,7	22,0	6,4
T2HG 10-1/4	M10FA1/4N	10-MTA-7-4	10	1/4	37,3	17,5	19,0	7,5
T2HG 10-3/8	M10FA3/8N	10-MTA-7-6	10	3/8	37,3	17,5	22,0	7,5
T2HG 10-1/2	M10FA1/2N	10-MTA-7-8	10	1/2	42,1	17,5	27,0	7,5
T2HG 12-1/4	M12FA1/4N	12-MTA-7-4	12	1/4	41,3	23,0	19,0	9,1
T2HG 12-3/8	M12FA3/8N	12-MTA-7-6	12	3/8	42,9	23,0	22,0	9,1
T2HG 12-1/2	M12FA1/2N	12-MTA-7-8	12	1/2	47,6	23,0	27,0	9,1
T2HG 16-1/2	M16FA1/2N	16-MTA-7-8	16	1/2	49,2	24,6	27,0	12,7
T2HG 18-3/4	M18FA3/4N	18-MTA-7-12	18	3/4	52,4	24,6	33,0	14,0
T2HG 20-1/2	M20FA1/2N	20-MTA-7-8	20	1/2	50,0	25,6	27,0	15,0
T2HG 20-3/4	M20FA3/4N	20-MTA-7-12	20	3/4	53,2	25,4	33,0	15,1
T2G 25-1	M25FA1N	25-MTA-7-16	25	1	66,7	31,8	41,0	19,8

NOTE: Tube stub is pre-grooved as standard.

Dimensions for reference only, subject to change.

Generic (non-grooved) can be ordered through Quick Response Department.
 Add -Z6 for assembly of nuts and ferrules on the tube stub end.

BSP Taper Female Adapter For fractional tube

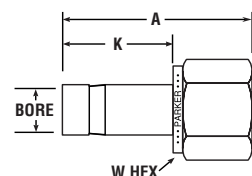
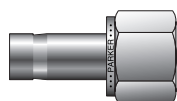

CPI™ PART NO.	A-LOK® PART NO.	INTER- CHANGES WITH	INCHES					
			TUBE O. D.	BSPT THREAD	A	K	W HEX	BORE
4-2K T2HG	4FA2K	4-TR-7-2RT	1/4	1/8-28	1.31	.64	9/16	.156
4-4K T2HG	4FA4K	4-TR-7-4RT	1/4	1/4-19	1.48	.64	3/4	.156
6-4K T2HG	6FA4K	6-TR-7-4RT	3/8	1/4-19	1.56	.72	3/4	.281
6-6K T2HG	6FA6K	6-TR-7-6RT	3/8	3/8-19	1.63	.72	7/8	.281
8-4K T2HG	8FA4K	8-TR-7-4RT	1/2	1/4-19	1.83	.98	3/4	.375
8-6K T2HG	8FA6K	8-TR-7-6RT	1/2	3/8-19	1.89	.98	7/8	.375
8-8K T2HG	8FA8K	8-TR-7-8RT	1/2	1/2-14	2.14	.98	1-1/16	.375

NOTE: Tube stub is pre-grooved as standard.

Dimensions for reference only, subject to change.

Generic (non-grooved) can be ordered through Quick Response Department.
 Add -Z6 for assembly of nuts and ferrules on the tube stub end.

BSP Taper Female Adapter For metric tube

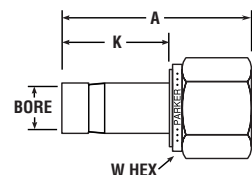
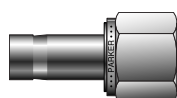

CPI™ PART NO.	A-LOK® PART NO.	INTER- CHANGES WITH	MILLIMETERS					
			TUBE O. D.	BSPT THREAD	A	K	W HEX	BORE
T2HG 3-1/8K	M3FA1/8K	3-MTA-7-2RT	3	1/8	27,8	13,5	14,0	1,8
T2HG 4-1/8K	M4FA1/8K	4-MTA-7-2RT	4	1/8	28,6	14,3	14,0	2,0
T2HG 6-1/8K	M6FA1/8K	6-MTA-7-2RT	6	1/8	30,2	15,9	14,0	4,0
T2HG 8-1/4K	M8FA1/4K	8-MTA-7-4RT	8	1/4	39,1	16,7	19,0	6,4
T2HG 10-1/4K	M10FA1/4K	10-MTA-7-4RT	10	1/4	36,5	17,5	19,0	7,5
T2HG 10-3/8K	M10FA3/8K	10-MTA-7-6RT	10	3/8	31,8	17,5	22,0	7,5
T2HG 10-1/2K	M10FA1/2K	10-MTA-7-8RT	10	1/2	41,3	17,5	27,0	7,5
T2HG 12-1/4K	M12FA1/4K	12-MTA-7-4RT	12	1/4	40,5	23,0	19,0	9,1
T2HG 12-3/8K	M12FA3/8K	12-MTA-7-6RT	12	3/8	43,7	23,0	22,0	9,1
T2HG 12-1/2K	M12FA1/2K	12-MTA-7-8RT	12	1/2	46,8	23,0	27,0	9,1
T2HG 16-1/2K	M16FA1/2K	16-MTA-7-8RT	16	1/2	48,4	24,6	27,0	12,7
T2HG 18-3/4K	M18FA3/4K	18-MTA-7-12RT	18	3/4	51,6	24,6	32,0	14,0
T2HG 20-3/4K	M20FA3/4K	20-MTA-7-12RT	20	3/4	52,4	25,4	32,0	15,1
T2HG 25-1K	M25FA1K	25-MTA-7-16RT	25	1	66,7	31,8	41,0	19,8

NOTE: Tube stub is pre-grooved as standard.

Dimensions for reference only, subject to change.

Add -Z6 for assembly of nuts and ferrules on the tube stub end.

BSPP Female Adapter For fractional tube

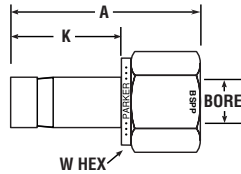
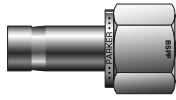

CPI™ PART NO.	A-LOK® PART NO.	INTER- CHANGES WITH	INCHES						
			TUBE O. D.	BSPP THREAD	A	K	W HEX	BORE	
4-4R T2HG	4FA4R	4-TA-7-4RP	1/4	1/4	1.68	.63	3/4	.18	
6-6R T2HG	6FA6R	6-TA-7-6RP	3/8	3/8	1.53	.69	7/8	.28	
8-8R T2HG	8FA8R	8-TA-7-8RP	1/2	1/2	1.91	.91	1-1/16	.39	

NOTE: Copper washer must be used for this design.

Dimensions for reference only, subject to change.

Tube stub is pre-grooved as standard. Generic (non-grooved) can be ordered through Quick Response Department.
 Add -Z6 for assembly of nuts and ferrules on the tube stub end.

BSPP Female Adapter For metric tube

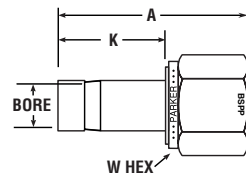
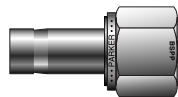

CPI™ PART NO.	A-LOK® PART NO.	INTER- CHANGES WITH	MILLIMETERS						
			TUBE O. D.	BSPP THREAD	A	K	W HEX	BORE	
T2HG 3-1/8R	M3FA1/8R	3-MTA-7-2RP	3	1/8	28,6	13,5	14,0	1,8	
T2HG 3-1/4R	M3FA1/4R	3-MTA-7-4RP	3	1/4	28,6	13,7	19,0	1,6	
T2HG 4-1/8R	M4FA1/8R	4-MTA-7-2RP	4	1/8	29,4	14,3	14,0	2,0	
T2HG 6-1/8R	M6FA1/8R	6-MTA-7-4RP	6	1/8	31,0	15,9	14,0	4,0	
T2HG 6-1/4R	M6FA1/4R	6-MTA-7-4RP	6	1/4	37,3	15,9	19,0	4,0	
T2HG 8-1/4R	M8FA1/4R	8-MTA-7-4RP	8	1/4	38,1	16,7	19,0	6,4	
T2HG 10-1/4R	M10FA1/4R	10-MTA-7-4RP	10	1/4	38,9	17,5	19,0	7,5	
T2HG 10-1/2R	M10FA1/2R	10-MTA-7-8RP	10	1/2	43,7	17,5	27,0	7,5	
T2HG 12-3/8R	M12FA3/8R	12-MTA-7-6RP	12	3/8	44,5	23,0	22,0	9,1	
T2HG 12-1/2R	M12FA1/2R	12-MTA-7-8RP	12	1/2	48,4	23,0	27,0	9,1	
T2HG 16-1/2R	M16FA1/2R	16-MTA-7-8RP	16	1/2	50,0	24,6	27,0	12,7	
T2HG 18-3/4R	M18FA3/4R	18-MTA-7-12RP	18	3/4	53,2	24,6	33,0	14,0	
T2HG 20-3/4R	M20FA3/4R	20-MTA-7-12RP	20	3/4	54,0	25,4	33,0	15,1	
T2HG 25-1R	M25FA1R	25-MTA-7-16RP	25	1	67,5	31,8	41,0	19,8	

NOTE: Copper washer must be used for this design.

Dimensions for reference only, subject to change.

Tube stub is pre-grooved as standard. Generic (non-grooved) can be ordered through Quick Response Department.
 Add -Z6 for assembly of nuts and ferrules on the tube stub end.

Push-Lok to Tube Adapter For fractional tube

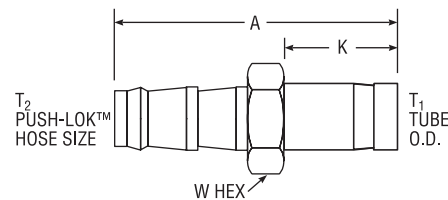
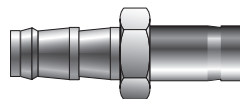

CPI™ PART NO.	A-LOK® PART NO.	INTER- CHANGES WITH	INCHES				
			T ₁ TUBE O. D.	T ₂ HOSE SIZE	A	K	W HEX
4-4 P2T2	4P2TU4	PB4-TA4	1/4	-4	1.80	.64	7/16
6-6 P2T2	6P2TU6	PB6-TA6	3/8	-6	2.02	.72	9/16
8-8 P2T2	8P2TU8	PB8-TA8	1/2	-8	2.42	.98	11/16

NOTE: Drawing does not show Push-Lok collar.

Dimensions for reference only, subject to change.

Tube stub is pre-grooved as standard. Generic (non-grooved) can be ordered through Quick Response Department.
 Add -Z6 for assembly of nuts and ferrules on the tube stub end.

Color Coding

For easy reference, table column headings are color indicated as follows:

fractional



metric



Push-Lok to Male Adapter
For fractional tube

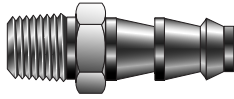

CPI™ PART NO.	A-LOK® PART NO.	INTER- CHANGES WITH	INCHES					
			T ₂ NPT PIPE THREAD	T ₁ HOSE SIZE	A	B	R	W HEX
4-4 P2HF	4-4 P2HF	PB4-PM4	1/4	-4	1.65	0.80	.56	9/16
6-6 P2HF	6-6 P2HF	PB6-PM6	3/8	-6	1.828	0.95	.56	11/16
8-8 P2HF	8-8 P2HF	PB8-PM8	1/2	-8	2.194	1.10	.75	7/8

NOTE: Drawing does not show Push-Lok collar.

Dimensions for reference only, subject to change.

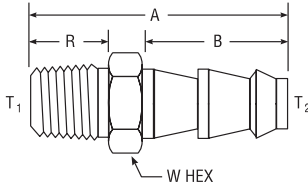

Push-Lok to CPI™/A-LOK®
For fractional tube

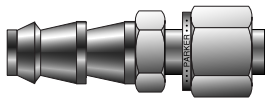

CPI™ PART NO.	A-LOK® PART NO.	INTER- CHANGES WITH	INCHES				
			T ₁ TUBE O.D.	T ₂ HOSE SIZE	A	K	W HEX
4-4 P2BZ6	4-4 P2LZ6	PB4-TA4	1/4	-4	1.77	0.72	7/16
6-6 P2BZ6	6-6 P2LZ6	PB6-TA6	3/8	-6	1.98	0.78	9/16
8-8 P2BZ6	8-8 P2LZ6	PB8-TA8	1/2	-8	2.42	1.03	11/16

NOTE: A dimension is typical finger-tight.

Dimensions for reference only, subject to change.

Drawing does not show Push-Lok collar. Assembly includes nut and ferrules.

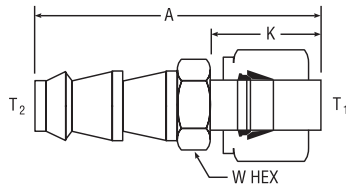

Push-Lok to Port Connector
For fractional tube

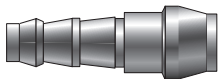

CPI™ PART NO.	A-LOK® PART NO.	INCHES			
		T ₁ HOSE SIZE	T ₂ PORT SIZE	A	B
4-6 ZPB2	4-6 ZPC2	-4	3/8	1.40	.80

NOTE: Drawing does not show Push-Lok collar and size 6 A-LOK® nut.

Dimensions for reference only, subject to change.

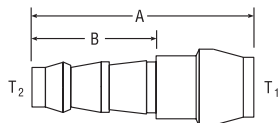

Lapped Joint Tube Adapters For metric tube

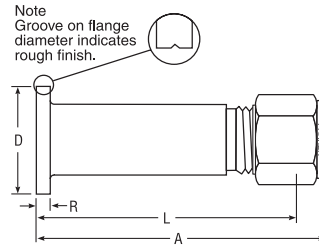
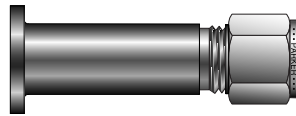

CPI™ PART NO.	A-LOK® PART NO.	INTER-CHANGES WITH	MILLIMETERS							SURFACE FINISH
			TUBE O.D.	FLANGE SIZE	A	D	L	R		
LJFBZ10-5	M10LJF-5	10M0-1-0005	10	DN15(1/2"NB)	83,0	34,5	75,5	6,5	Smooth	3,2-6,3 Ra
LJFBZ10-9	M10LJF-9	10M0-1-0006	10	DN15(1/2"NB)	83,0	34,5	75,5	6,5	Rough	6,3-12,5 Ra
LJFBZ12-5	M12LJF-5	—	12	DN15(1/2"NB)	85,0	34,5	75,4	6,5	Smooth	3,2-6,3 Ra
LJFBZ12-9	M12LJF-9	—	12	DN15(1/2"NB)	85,0	34,5	75,4	6,5	Rough	6,3-12,5 Ra

NOTE: Groove on flange diameter indicates rough finish.

Dimensions for reference only, subject to change.

The lapped joint tube adaptor is a fitting designed to be used with a lap joint flange which enables a direct hook-up to the instrument tube from the process line.

The compression fitting is incorporated into the body of the adaptor thus the number of components needed for hook-up is reduced. It is therefore cost efficient as well as space saving.

The face of the fitting forms the gasket face of the flange and comes with either a smooth or serrated surface finish.

Adaptors to suit other tube and flange sizes may be furnished upon request.

For the full line of Manifold Accessories, see Catalog 4190-FP-ACC.

DP Transmitter Calibration Adapters For fractional tube

Parker CPI™/A-LOK® adapters connect directly to the bleed port of a differential pressure transmitter so that the calibration process can be simplified. Two sizes of adapters (1/4-28 Thd., 5/16-24 Thd.) are available to fit the vent ports of Rosemount, Honeywell, and Foxboro DP transmitters. Both adapters are available in 316SS.

TRANSMITTER TYPE	PARKER PART NO.	INTERCHANGES WITH
(1) Rosemount/Foxboro	4-2 ZH2LX-SS-D950373	—
(2) Honeywell	4-2 ZH2LX-SS-D940336	SS-400-1-0257
(3) Rosemount/Yokogawa	4-2 ZH2LX-SS-D030297	SS-400-1-0253
(4) ABB	4-2 ZH2LX-SS-D030249	—

STRAIGHT THREAD	INCHES										
	A	B	C	D	E	F	G	H	J	HEX	
(1) 5/16-24	2.32	1.41	.70	2.03	.24	.60	.25	.06	.41	1/2	
(2) 1/4-28	1.75	.80	.70	1.46	.47	.60	.20	.03	—	1/2	
(3) 5/16-24	2.32	1.41	.70	2.03	.40	.60	.25	.05	.41	1/2	
(4) 1/4-28	1.74	.74	.70	1.44	.30	.60	.18	.05	—	1/2	

Dimensions for reference only, subject to change.

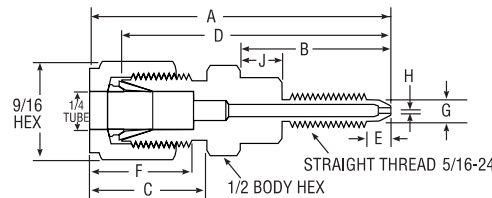
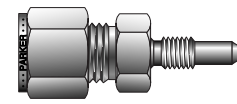
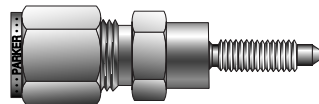

Calibration Adapter for
Rosemount/Foxboro DP Transmitters

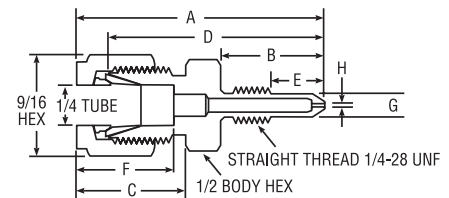

Calibration Adapter for
Honeywell DP Transmitters

Color Coding

For easy reference, table column headings are color indicated as follows:

fractional

metric

37° Flare (AN) to CPI™/A-LOK® For fractional tube

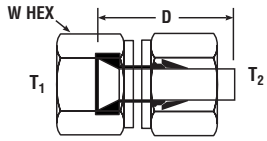
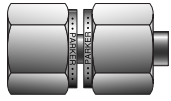

CPI™ PART NO.	A-LOK® PART NO.	INTER- CHANGES WITH	INCHES		
			TUBE O. D.	D	W HEX
2-2 X6HBZ6	2X6TU2	200-A-2 ANF	1/8	0.88	3/8
4-4 X6HBZ6	4X6TU4	400-A-4 ANF	1/4	0.96	9/16
6-6 X6HBZ6	6X6TU6	600-A-6 ANF	3/8	1.07	11/16
8-8 X6HBZ6	8X6TU8	810-A-8 ANF	1/2	1.37	7/8
12-12 X6HBZ6	12X6TU12	1210-A-12ANF	3/4	1.49	1-1/4
16-16 X6HBZ6	16X6TU16	1610-A-16ANF	1	1.80	1-1/2

Dimensions for reference only, subject to change.

37° Flare Connector For fractional tube

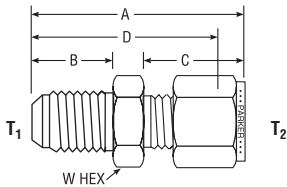
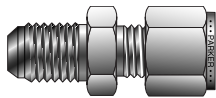

CPI™ PART NO.	A-LOK® PART NO.	INTER- CHANGES WITH	INCHES						
			FLARE END	TUBE O. D.	A	B	C	D	W HEX
2-1 XHBZ	2XASC1	100-6-2 AN	1/8	1/16	1.07	.45	0.43	.92	7/16
2-2 XHBZ	2XASC2	200-6-2 AN	1/8	1/8	1.28	.45	0.60	1.02	7/16
4-2 XHBZ	4XASC2	200-6-4 AN	1/4	1/8	1.39	.55	0.60	1.13	1/2
3-3 XHBZ	3XASC3	300-6-3 AN	3/16	3/16	1.32	.48	0.64	1.06	7/16
4-4 XHBZ	4XASC4	400-6-4 AN	1/4	1/4	1.48	.55	0.70	1.19	1/2
5-5 XHBZ	5XASC5	500-6-5 AN	5/16	5/16	1.52	.55	0.73	1.22	9/16
4-6 XHBZ	4XASC6	600-6-4 AN	1/4	3/8	1.56	.55	0.76	1.27	5/8
6-6 XHBZ	6XASC6	600-6-6 AN	3/8	3/8	1.56	.56	0.76	1.27	5/8
8-8 XHBZ	8XASC8	810-6-8 AN	1/2	1/2	1.81	.66	0.87	1.41	13/16
10-10 XHBZ	10XASC10	1010-6-10 AN	5/8	5/8	1.93	.76	0.87	1.53	15/16
12-12 XHBZ	12XASC12	1210-6-12 AN	3/4	3/4	2.11	.86	0.87	1.70	1-1/8
16-16 XHBZ	16XASC16	1610-6-16 AN	1	1	2.43	.91	1.05	1.94	1-3/8

NOTE: A and C dimensions are typical finger-tight.

Dimensions for reference only, subject to change.

37° Flare Bulkhead Connector For fractional tube

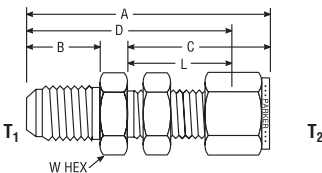
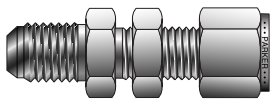

CPI™ PART NO.	A-LOK® PART NO.	INTER- CHANGES WITH	INCHES							
			FLARE END	TUBE O. D.	A	D	C	L	B	W HEX
2-2 XH2BZ	2XABC2	200-61-2 AN	1/8	1/8	1.91	1.65	1.23	0.97	.45	1/2
3-3 XH2BZ	3XABC3	300-61-3 AN	3/16	3/16	1.98	1.71	1.26	1.00	.48	9/16
4-2 XH2BZ	4XABC2	200-61-4 AN	1/4	1/8	2.04	1.78	1.23	0.97	.55	5/8
4-4 XH2BZ	4XABC4	400-61-4 AN	1/4	1/4	2.12	1.83	1.31	1.02	.55	5/8
5-5 XH2BZ	5XABC5	500-61-5 AN	5/16	5/16	2.21	1.92	1.41	1.12	.55	11/16
4-6 XH2BZ	4XABC6	600-61-4 AN	1/4	3/8	2.25	1.96	1.44	1.15	.55	3/4
6-6 XH2BZ	6XABC6	600-61-6 AN	3/8	3/8	2.25	1.96	1.44	1.15	.56	3/4
8-8 XH2BZ	8XABC8	810-61-8 AN	1/2	1/2	2.59	2.19	1.65	1.25	.66	15/16
10-10 XH2BZ	10XABC10	1010-61-10 AN	5/8	5/8	2.74	2.34	1.68	1.28	.76	1-1/16
12-12 XH2BZ	12XABC12	1210-61-12 AN	3/4	3/4	3.11	2.71	1.87	1.47	.86	1-3/16
16-16 XH2BZ	16XABC16	1610-61-16 AN	1	1	3.65	3.16	2.27	1.78	.91	1-9/16

NOTE: A and C dimensions are typical finger-tight.

Dimensions for reference only, subject to change.

For bulkhead hole drill size and maximum bulkhead thickness, [see page 32, Part BC](#).

Introduction

BSPP / SAE Straight Thread Fittings Installation Procedure

1. Lubricate O-ring with a lubricant that is compatible with the system.
2. Screw fitting into the straight thread port until the metal back-up washer contacts the face of the port.
3. Position the fitting by backing it out no more than one turn.
4. Hold the fitting in position and tighten the locknut until the washer contacts the face of the port. (See torque chart.)

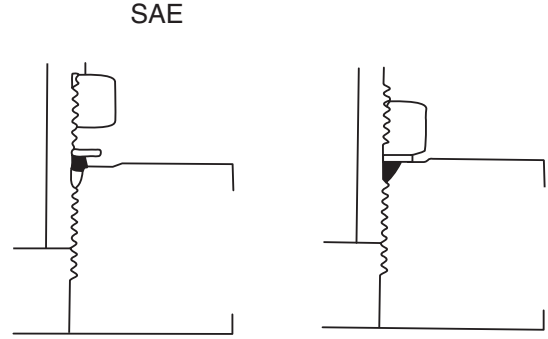
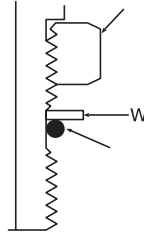

NOTE: WLN Lock Nuts are ordered separately by size and part number. [Refer to page 77.](#)

SIZE	STRAIGHT PORT		ADJUSTABLE PORT	
	TORQUE (IN-LBS)	(F.F.F.T.)	TORQUE (IN-LBS)	(F.F.F.T.)
4	245 ± 10	1.0 ± .25	200 ± 10	1.5 ± 25
6	630 ± 25	1.5 ± .25	400 ± 10	1.5 ± 25
8	1150 ± 50	1.5 ± .25	640 ± 10	1.5 ± 25
10	1550 ± 50	1.5 ± .25	1125 ± 50	1.5 ± 25
12	2050 ± 50	1.5 ± .25	1450 ± 50	1.5 ± 25
16	3000 ± 50	1.5 ± .25	2150 ± 50	1.5 ± 25
20	3400 ± 100	1.5 ± .25	2800 ± 100	2.0 ± 25
24	4500 ± 100	1.5 ± .25	3450 ± 100	2.0 ± 25

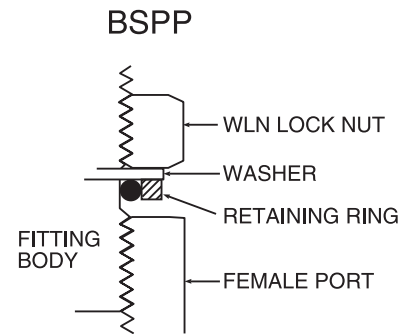

NOTES:

- Restrain fitting body on adjustables if necessary in installation.
- Values in charts are for assemblies with O-ring lubricated.
- Use upper limits of torque ranges for stainless steel fittings.

Face Seal O-Ring Fittings Installation Procedure

The O-ring requires a smooth, flat seating surface. This surface must be perpendicular to the axis of the threads.

1. Turn the O-ring seal fitting in the port until finger tight.
2. The “squeezing” effect on the O-ring can be felt during the last 1/4 turn.
3. Snug lightly with a wrench.

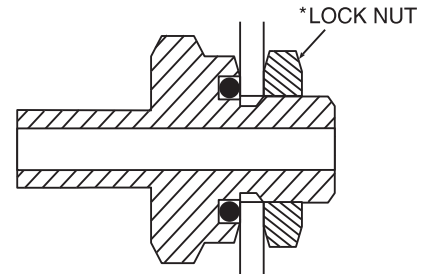

*Typical Application

The fitting can be adapted as a bulkhead fitting on thin wall tanks or vessels, eliminating welding, brazing or threading. Simply order the L5N locknut to take advantage of this option.

Notes:

Standard O-rings are nitrile material. For other O-rings, state material after the part number.

L5N locknuts are ordered separately by size and part number. [Refer to page 77.](#)

PORT SIZE	STRAIGHT THREAD SIZE	STRAIGHT THREAD MACHINE LENGTH	L5N LOCKNUT THICKNESS	MAXIMUM TANK WALL THICKNESS
2	5/16-24	.297	.219	.078 = 5/64
3	3/8-24	.297	.219	.078 = 5/64
4	7/16-20	.360	.250	.109 = 7/65
5	1/2-20	.360	.250	.109 = 7/64
6	9/16-18	.391	.265	.125 = 1/8
8	3/4-16	.438	.312	.125 = 1/8
10	7/8-14	.500	.360	.140 = 9/64
12	1-1/16-12	.594	.406	.188 = 3/16
14	1-13/16-12	.594	.406	.188 = 3/16
16	1-5/16-12	.594	.406	.188 = 3/16

O-rings used with SAE/MS straight threads are nitrile. Other O-ring materials are available on request. Lubricate O-ring with a lubricant compatible with the system fluid, environment and O-ring material.

**Male Connector to SAE
 Straight Thread**
For fractional tube

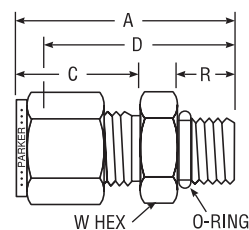
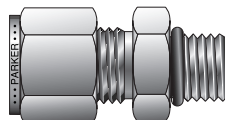

CPT™ PART NO.	A-LOK® PART NO.	INTER- CHANGES WITH	INCHES						O-RING AS UNIFORM DASH NO.	
			TUBE O.D.	STRAIGHT THREAD SIZE	A	C	D	R		W HEX
1-2 ZHBA	1M1SC2	100-1-2 ST	1/16	5/16-24	0.92	0.43	0.77	.30	7/16	3-902
2-2 ZHBA	2M1SC2	200-1-2 ST	1/8	5/16-24	1.18	0.60	0.92	.30	7/16	3-902
2-6 ZHBA	2M1SC6	200-1-6 ST	1/8	9/16-18	1.35	0.60	1.06	.39	11/16	3-906
3-3 ZHBA	3M1SC3	300-1-3 ST	3/16	3/8-24	1.20	0.64	0.94	.30	1/2	3-903
4-4 ZHBA	4M1SC4	400-1-4 ST	1/4	7/16-20	1.34	0.70	1.05	.36	9/16	3-904
4-6 ZHBA	4M1SC6	400-1-6 ST	1/4	9/16-18	1.40	0.70	1.11	.39	11/16	3-906
4-8 ZHBA	4M1SC8	400-1-8 ST	1/4	3/4-16	1.48	0.70	1.19	.44	7/8	3-908
4-10 ZHBA	4M1SC10	400-1-10 ST	1/4	7/8-14	1.60	0.70	1.31	.50	1	3-910
5-5 ZHBA	5M1SC5	500-1-5 ST	5/16	1/2-20	1.37	0.73	1.08	.36	5/8	3-905
6-4 ZHBA	6M1SC4	600-1-4 ST	3/8	7/16-20	1.40	0.76	1.11	.36	5/8	3-904
6-6 ZHBA	6M1SC6	600-1-6 ST	3/8	9/16-18	1.46	0.76	1.17	.39	11/16	3-906
6-8 ZHBA	6M1SC8	600-1-8 ST	3/8	3/4-16	1.54	0.76	1.25	.44	7/8	3-908
6-10 ZHBA	6M1SC10	600-1-10 ST	3/8	7/8-14	1.67	0.76	1.38	.50	1.00	3-910
8-6 ZHBA	8M1SC6	810-1-6 ST	1/2	9/16-18	1.54	0.87	1.14	.39	7/8	3-906
8-8 ZHBA	8M1SC8	810-1-8 ST	1/2	3/4-16	1.65	0.87	1.25	.44	7/8	3-908
8-12 ZHBA	8M1SC12	810-1-12 ST	1/2	1-1/16-12	1.93	0.87	1.53	.59	1-1/4	3-912
10-10 ZHBA	10M1SC10	1010-1-10 ST	5/8	7/8-14	1.78	0.87	1.38	.50	1	3-910
12-10 ZHBA	12M1SC10	1210-1-10 ST	3/4	7/8-14	1.68	0.87	1.28	.50	1-1/8	3-910
12-12 ZHBA	12M1SC12	1210-1-12 ST	3/4	1-1/16-12	1.93	0.87	1.53	.59	1-1/4	3-912
12-14 ZHBA	14M1SC14	1410-1-14 ST	7/8	1-3/16-12	1.93	0.87	1.53	.59	1-3/8	3-914
16-12 ZHBA	16M1SC12	1610-1-12 ST	1	1-1/16-12	2.12	1.05	1.63	.59	1-3/8	3-912
16-16 ZHBA	16M1SC16	1610-1-16 ST	1	1-5/16-12	2.15	1.04	1.66	.59	1-1/2	3-916
20-20 ZHBA	20M1SC20	2010-1-20 ST	1-1/4	1-5/8-12	2.59	1.52	1.82	.59	1-7/8	3-920
24-24 ZHBA	24M1SC24	2410-1-24 ST	1-1/2	1-7/8-12	3.05	1.77	1.99	.59	2-1/8	3-924
32-32 ZHBA	32M1SC32	3210-1-32 ST	2	2-1/2-12	4.00	2.47	2.53	.59	2-3/4	3-932

NOTE: A and C dimensions are typical finger-tight.

Dimensions for reference only, subject to change.

For use with SAE J.1926/1 port can also be used with MS-16142 port.

Sizes 20, 24, 32 require additional lubrication prior to assembly.

Parts are supplied with nitrile o-rings as standard. For Fluorocarbon o-rings, add the suffix "-VO". Other o-rings available upon request.

Color Coding

For easy reference, table column headings are color indicated as follows:

fractional



metric



Male SAE Straight Thread Elbow
For fractional tube

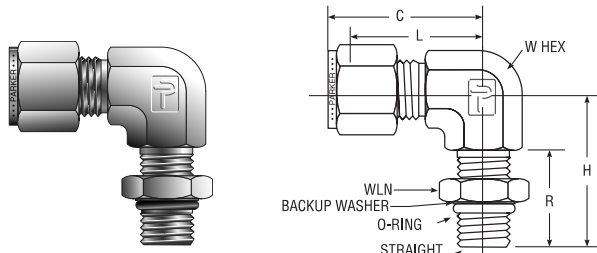

CPI™ PART NO.	A-LOK® PART NO.	INTER-CHANGES WITH	INCHES							O-RING ARP UNIFORM DASH NO.
			TUBE O.D.	STRAIGHT THREAD SIZE	C	H	L	R	W HEX	
4-4 C5BZ	4M5SEL4	400-2-4ST	1/4	7/16-20	1.12	1.18	0.83	0.83	9/16	3-904
6-6 C5BZ	6M5SEL6	600-2-6ST	3/8	9/16-18	1.26	1.27	0.97	0.84	9/16	3-906
8-8 C5BZ	8M5SEL8	810-2-8ST	1/2	3/4-16	1.48	1.48	1.08	0.97	3/4	3-908
12-12 C5BZ	12M5SEL12	1210-2-12ST	3/4	1-1/16-12	1.63	1.92	1.23	1.28	1-1/16	3-912
16-16 C5BZ	16M5SEL16	1610-2-16ST	1	1-5/16-12	1.91	2.11	1.42	1.28	1-5/16	3-916
24-24 C5BZ	24M5SEL24	2410-2-24ST	1-1/2	1-7/8-12	3.47	2.33	2.00	1.16	1-7/8	3-924

NOTE: C dimension is typical finger-tight. Dimensions for reference only, subject to change.
 Size 24 requires additional lubrication prior to assembly.
 Parts are supplied with nitrile o-rings as standard. For Fluorocarbon o-rings, add the suffix "-VO". Other o-rings available upon request.

BSPP Male Elbow (Positionable)
For fractional tube

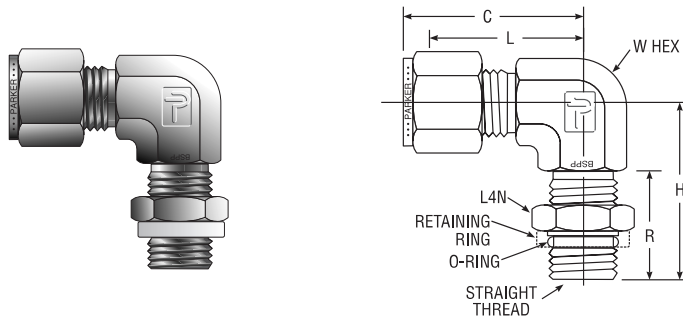

CPI™ PART NO.	A-LOK® PART NO.	INTER-CHANGES WITH	INCHES						
			TUBE O.D.	BSPP THREAD	C	H	L	R	W HEX
4-2R CBZ	4MSEL2R	400-2-2PR	1/4	1/8-28	1.06	1.04	0.77	0.81	9/16
4-4R CBZ	4MSEL4R	400-2-4PR	1/4	1/4-19	1.14	1.27	0.85	0.83	9/16
6-4R CBZ	6MSEL4R	600-2-4PR	3/8	1/4-19	1.20	1.27	0.85	0.83	9/16
6-6R CBZ	6MSEL6R	600-2-6PR	3/8	3/8-19	1.31	1.46	1.02	0.83	3/4
8-8R CBZ	8MSEL4R	810-2-4PR	1/2	1/4-19	1.50	1.38	1.10	0.83	7/8
8-6R CBZ	8MSEL6R	810-2-6PR	1/2	3/8-19	1.50	1.46	1.10	0.85	7/8
8-8R CBZ	8MSEL8R	810-2-8PR	1/2	1/2-14	1.50	1.71	1.10	1.09	7/8
10-10R CBZ	10MSEL8R	1010-2-8PR	5/8	1/2-14	1.50	1.81	1.10	1.09	1-1/16
12-8R CBZ	12MSEL8R	1210-2-8PR	3/4	1/2-14	1.57	1.81	1.17	1.09	1-1/16
12-12R CBZ	12MSEL12R	1210-2-12PR	3/4	3/4-14	1.57	1.92	1.17	1.20	1-1/16
16-12R CBZ	16MSEL12R	1610-2-12PR	1	3/4-14	1.93	2.11	1.45	1.20	1-5/16
16-16R CBZ	16MSEL16R	1610-2-16PR	1	1-11	1.93	2.11	1.45	1.20	1-5/16

NOTE: C dimension is typical finger-tight. Dimensions for reference only, subject to change.
 Connects fractional tube to female ISO parallel thread.
 Parts are supplied with nitrile o-rings as standard. For Fluorocarbon o-rings, add the suffix "-VO". Other o-rings available upon request.

Color Coding

For easy reference, table column headings are color indicated as follows:



**Male Run Tee SAE
 Straight Thread**
For fractional tube

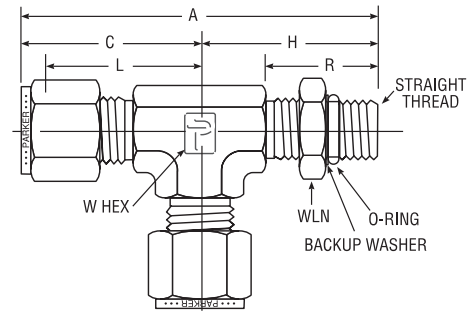
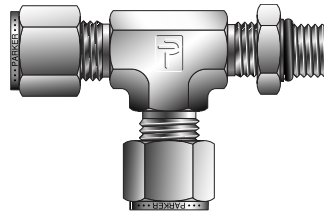

CPI™ PART NO.	A-LOK® PART NO.	INTER- CHANGES WITH	INCHES								O-RING ARP UNIFORM DASH NO.
			TUBE O.D.	TRAIGHT THREAD SIZE	A	C	H	L	R	W HEX	
4-4-4 R5BZ	4M5RT4	400-3TST	1/4	7/16-20	2.24	1.12	1.18	0.83	0.83	7/16	3-904
6-6-6 R5BZ	6M5RT6	600-3TST	3/8	9/16-18	2.53	1.26	1.27	0.97	0.84	9/16	3-906
8-8-8 R5BZ	8M5RT8	810-3TST	1/2	3/4-16	2.97	1.48	1.48	1.08	0.97	3/4	3-908
12-12-12 R5BZ	12M5RT12	1210-3TST	3/4	1-1/16-12	3.55	1.63	1.92	1.23	1.28	1-1/16	3-912
16-16-16 R5BZ	16M5RT16	1610-3TST	1	1-5/16-12	3.74	1.87	2.11	1.38	1.28	1-5/16	3-916

NOTE: A and C dimensions are typical finger-tight.

Dimensions for reference only, subject to change.

Parts are supplied with nitrile o-rings as standard. For Fluorocarbon o-rings, add the suffix "-VO". Other o-rings available upon request.

**BSPP Male Run Tee
 (Positionable)**
For fractional tube

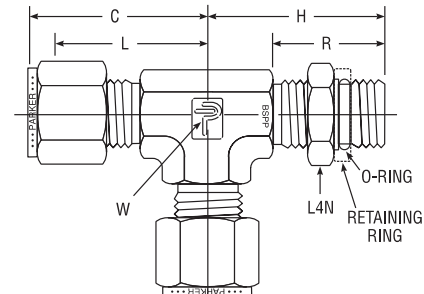
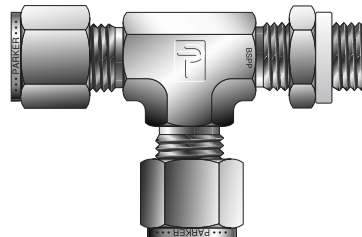

CPI™ PART NO.	A-LOK® PART NO.	INTER- CHANGES WITH	INCHES						
			TUBE O.D.	BSPP THREAD	C	H	L	R	W HEX
4-2R-4 RBZ	4MRT2R	400-3TRT	1/4	1/8-28	1.06	1.04	0.77	0.81	9/16
4-4R-4 RBZ	4MRT4R	400-3-4TRT	1/4	1/4-19	1.14	1.27	0.85	0.83	9/16
6-6R-6 RBZ	6MRT6R	600-3TRT	3/8	1/4-19	1.20	1.27	0.91	0.83	9/16
8-6R-8 RBZ	8MRT8R	810-3TRT	1/2	3/8-19	1.50	1.46	1.10	0.85	7/8
8-8R-8 RBZ	8MRT8R	810-3-8TRT	1/2	1/2-14	1.50	1.71	1.10	1.09	7/8
10-8R-10 RBZ	10MRT8R	1010-3TRT	5/8	1/2-14	1.50	1.81	1.10	1.09	1-1/16
12-8R-12 RBZ	12MRT8R	1210-3-8TRT	3/4	1/2-14	1.57	1.81	1.17	1.09	1-1/16
12-12R-12 RBZ	12MRT12R	1210-3TRT	3/4	3/4-14	1.57	1.92	1.17	1.20	1-1/16
16-16R-16 RBZ	16MRT16R	1610-3TRT	1	1-11	1.93	2.11	1.45	1.20	1-5/16

NOTE: C dimension is typical finger-tight.

Dimensions for reference only, subject to change.

Parts are supplied with nitrile o-rings as standard. For Fluorocarbon o-rings, add the suffix "-VO". Other o-rings available upon request.

Male Branch Tee
SAE Straight Thread
For fractional tube

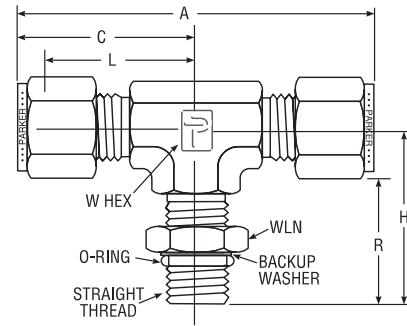
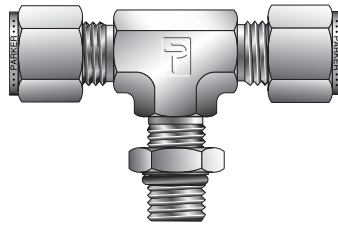

CPI™ PART NO.	A-LOK® PART NO.	INTER- CHANGES WITH	INCHES								O-RING ARP UNIFORM DASH NO.
			TUBE O.D.	STRAIGHT THREAD SIZE	A	C	H	L	R	W HEX	
4-4-4 S5BZ	4M5BT4	400-3TTS	1/4	7/16-20	2.24	1.19	1.19	0.81	0.81	7/16	3-904
6-6-6 S5BZ	6M5BT6	600-3TTS	3/8	9/16-18	2.52	1.26	1.27	0.97	0.84	9/16	3-906
8-8-8 S5BZ	8M5BT8	810-3TTS	1/2	3/4-16	2.96	1.48	1.48	1.08	0.97	3/4	3-908
12-12-12 S5BZ	12M5BT12	1210-3TTS	3/4	1-1/16-12	3.26	1.63	1.92	1.23	1.28	1-1/16	3-912
16-16-16 S5BZ	16M5BT16	1610-3TTS	1	1-5/16-12	3.74	1.87	2.11	1.38	1.28	1-5/16	3-916

NOTE: A and C dimensions are typical finger-tight.

Dimensions for reference only, subject to change.

Parts are supplied with nitrile o-rings as standard. For Fluorocarbon o-rings, add the suffix "-VO". Other o-rings available upon request.

**BSPP Male Branch
Tee (Positionable)**
For fractional tube

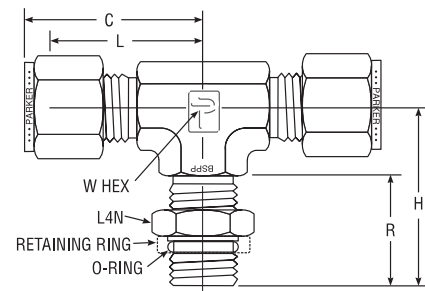
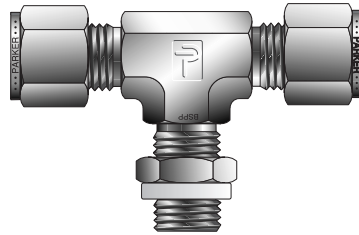

CPI™ PART NO.	A-LOK® PART NO.	INTER- CHANGES WITH	INCHES						
			TUBE O.D.	BSPP THREAD	C	H	L	R	W HEX
4-4-2R SBZ	4MBT2R	400-3TTR	1/4	1/8-28	1.06	1.25	0.77	0.81	9/16
4-4-4R SBZ	4MBT4R	400-3-4TTR	1/4	1/4-19	1.14	1.27	0.85	0.83	9/16
6-6-4R SBZ	6MBT4R	600-3TTR	3/8	1/4-19	1.20	1.27	0.91	0.83	9/16
8-8-6R SBZ	8MBT6R	810-3TTR	1/2	3/8-19	1.50	1.36	1.10	0.85	7/8
8-8-8R SBZ	8MBT8R	810-3-8TTR	1/2	1/2-14	1.50	1.71	1.10	1.09	7/8
10-10-8R SBZ	10MBT8R	1010-3TTR	5/8	1/2-14	1.50	1.81	1.10	1.09	1-1/16
12-12-8R SBZ	12MBT8R	1210-3-8TTR	3/4	1/2-14	1.57	1.81	1.17	1.09	1-1/16
12-12-12R SBZ	12MBT12R	1210-3-TTR	3/4	3/4-14	1.57	1.92	1.17	1.20	1-1/16
16-16-16R SBZ	16MBT16R	1610-3TTR	1	1-11	1.94	2.11	1.45	1.20	1-5/16

NOTE: C dimension is typical finger-tight.

Dimensions for reference only, subject to change.

Connects fractional tube to female ISO parallel thread.

Parts are supplied with nitrile o-rings as standard. For Fluorocarbon o-rings, add the suffix "-VO". Other o-rings available upon request.

Color Coding

For easy reference, table column headings are color indicated as follows:

fractional



metric



Long Male Connector SAE/MS Straight Thread For fractional tube

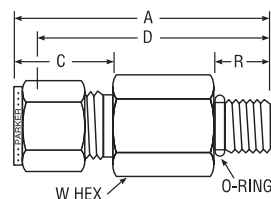
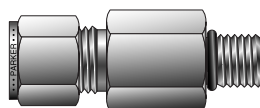

CPI™ PART NO.	A-LOK® PART NO.	INTER- CHANGES WITH	INCHES							ST O-RING UNIFORM SIZE NO.	
			T TUBE O.D.	S-SAE/MS THREAD SIZE	A	R	C	D	E MIN. OPENING		W HEX
4-4 ZH3BA	4-4 ZH3LA	400-1L-4ST	1/4	7/16-20	2.26	.36	0.70	1.97	.19	9/16	-904
6-6 ZH3BA	6-6 ZH3LA	600-1L-6ST	3/8	9/16-18	2.48	.39	0.76	2.19	.28	11/16	-906
8-8 ZH3BA	8-8 ZH3LA	810-1L-8ST	1/2	3/4-16	3.01	.44	0.86	2.58	.41	7/8	-908
12-12 ZH3BA	12-12 ZH3LA	1210-1L-12ST	3/4	1-1/16-12	3.88	.59	0.86	3.48	.62	1-1/4	-912
16-16 ZH3BA	16-16 ZH3LA	1610-1L-16ST	1	1-5/16-12	4.34	.59	1.04	3.86	.88	1-1/2	-916

NOTE: A and C dimensions are typical finger-tight.

Dimensions for reference only, subject to change.

Parts are supplied with nitrile o-rings as standard. For Fluorocarbon o-rings, add the suffix "-VO". Other o-rings available upon request.

45° Positionable Male Elbow SAE/MS Straight Thread For fractional tube

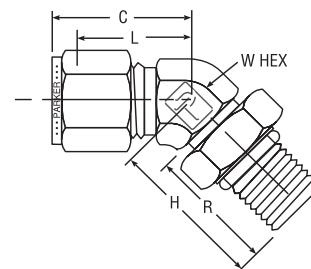
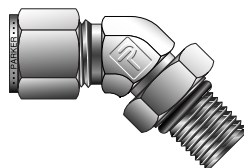

CPI™ PART NO.	A-LOK® PART NO.	INTER- CHANGES WITH	INCHES							O-RING UNIFORM DASH NO.
			STRAIGHT TUBE O.D.	THREAD SIZE	C	H	L	R	W HEX	
4-4 V5BZ	4M5VEL4	400-5-4ST	1/4	7/16-20	0.93	1.02	0.65	0.75	7/16	3-904
6-6 V5BZ	6M5VEL6	600-5-6ST	3/8	9/16-18	1.01	1.27	0.72	0.77	9/16	3-906
8-8 V5BZ	8M5VEL8	810-5-8ST	1/2	3/4-16	1.15	1.48	0.75	0.88	3/4	3-908
12-12 V5BZ	12M5VEL12	1210-5-12ST	3/4	1-1/16-12	1.63	1.92	1.23	1.16	1-1/16	3-912
16-16 V5BZ	16M5VEL16	1610-5-16ST	1	1-5/16-12	1.87	2.11	1.39	1.16	1-5/16	3-916

NOTE: C dimension is typical finger-tight.

Dimensions for reference only, subject to change.

• Adapts to SAE J1926 straight thread boss and MS16142 boss.

Parts are supplied with nitrile o-rings as standard. For Fluorocarbon o-rings, add the suffix "-VO". Other o-rings available upon request.

Male Connector to O-Ring Straight Thread
For fractional tube

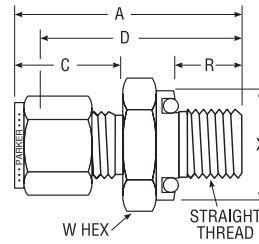
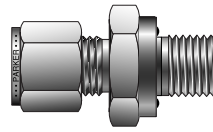

CPI™ PART NO.	A-LOK® PART NO.	INTER-CHANGES WITH	INCHES								O-RING ARP UNIFORM DASH NO.
			TUBE O. D.	STRAIGHT THREAD SIZE	A	C	D	R	X DIA.	W HEX	
1-2 ZHBA5	1M2SC2	100-1-OR	1/16	5/16-24	1.06	0.43	0.91	.34	.55	9/16	2-011
2-2 ZHBA5	2M2SC2	200-1-OR	1/8	5/16-24	1.29	0.60	1.03	.34	.55	9/16	2-011
3-3 ZHBA5	3M2SC3	300-1-OR	3/16	3/8-24	1.35	0.64	1.09	.38	.62	5/8	2-012
4-4 ZHBA5	4M2SC4	400-1-OR	1/4	7/16-20	1.51	0.70	1.22	.41	.74	3/4	2-111
5-5 ZHBA5	5M2SC5	500-1-OR	5/16	1/2-20	1.61	0.73	1.31	.44	.86	7/8	2-112
6-6 ZHBA5	6M2SC6	600-1-OR	3/8	9/16-18	1.67	0.76	1.38	.44	.93	15/16	2-113
8-8 ZHBA5	8M2SC8	810-1-OR	1/2	3/4-16	1.81	0.87	1.41	.47	1.12	1-1/8	2-116
10-10 ZHBA5	10M2SC10	1010-1-OR	5/8	7/8-14	1.90	0.87	1.50	.47	1.30	1-3/8	2-212
12-12 ZHBA5	12M2SC12	1210-1-OR	3/4	1-1/16-12	2.06	0.87	1.66	.56	1.49	1-1/2	2-215
14-12 ZHBA5	14M2SC12	1410-1-OR	7/8	1-1/16-12	2.06	0.87	1.66	.56	1.49	1-1/2	2-215
16-16 ZHBA5	16M2SC16	1610-1-OR	1	1-5/16-12	2.30	1.05	1.81	.56	1.74	1-3/4	2-219

NOTE: A and C dimensions are typical finger-tight.

Dimensions for reference only, subject to change.

Parts are supplied with nitrile o-rings as standard. For Fluorocarbon o-rings, add the suffix "-VO". Other o-rings available upon request.

Male Connector to O-Ring Pipe Thread
For fractional tube

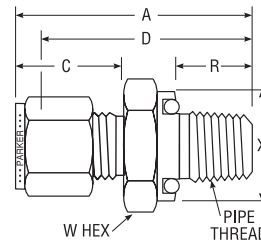
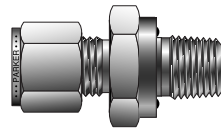

CPI™ PART NO.	A-LOK® PART NO.	INTER-CHANGES WITH	INCHES								O-RING ARP UNIFORM DASH NO.
			TUBE O. D.	NPT PIPE SIZE	A	C	D	R	X DIA.	W HEX	
1-2 ZHBF5	1M3SC2	100-1-2-OR	1/16	1/8	1.12	0.43	0.97	.28	.74	3/4	2-111
2-2 ZHBF5	2M3SC2	200-1-2-OR	1/8	1/8	1.29	0.60	1.03	.28	.74	3/4	2-111
2-4 ZHBF5	2M3SC4	200-1-4-OR	1/8	1/4	1.43	0.60	1.17	.38	.93	15/16	2-113
3-2 ZHBF5	3M3SC2	300-1-2-OR	3/16	1/8	1.32	0.64	1.06	.28	.74	3/4	2-111
3-4 ZHBF5	3M3SC4	300-1-4-OR	3/16	1/4	1.46	0.64	1.20	.38	.93	15/16	2-113
4-2 ZHBF5	4M3SC2	400-1-2-OR	1/4	1/8	1.38	0.70	1.09	.28	.74	3/4	2-111
4-4 ZHBF5	4M3SC4	400-1-4-OR	1/4	1/4	1.51	0.70	1.22	.38	.93	15/16	2-113
4-6 ZHBF5	4M3SC6	400-1-6-OR	1/4	3/8	1.57	0.70	1.28	.41	1.12	1-1/8	2-116
5-2 ZHBF5	5M3SC2	500-1-2-OR	5/16	1/8	1.43	0.73	1.13	.28	.74	3/4	2-111
5-4 ZHBF5	5M3SC4	500-1-4-OR	5/16	1/4	1.46	0.73	1.25	.38	.93	15/16	2-113
6-2 ZHBF5	6M3SC2	600-1-2-OR	3/8	1/8	1.45	0.76	1.16	.28	.74	3/4	2-111
6-4 ZHBF5	6M3SC4	600-1-4-OR	3/8	1/4	1.57	0.76	1.28	.38	.93	15/16	2-113
6-6 ZHBF5	6M3SC6	600-1-6-OR	3/8	3/8	1.63	0.76	1.34	.41	1.12	1-1/8	2-116
6-8 ZHBF5	6M3SC8	600-1-8-OR	3/8	1/2	1.85	0.76	1.56	.53	1.30	1-3/8	2-212
8-4 ZHBF5	8M3SC4	810-1-4-OR	1/2	1/4	1.68	0.87	1.28	.38	.93	15/16	2-113
8-6 ZHBF5	8M3SC6	810-1-6-OR	1/2	3/8	1.76	0.87	1.36	.41	1.12	1-1/8	2-116
8-8 ZHBF5	8M3SC8	810-1-8-OR	1/2	1/2	1.98	0.87	1.58	.53	1.30	1-3/8	2-212
10-8 ZHBF5	10M3SC8	1010-1-8-OR	5/8	1/2	1.96	0.87	1.56	.53	1.30	1-3/8	2-212
10-12 ZHBF5	10M3SC12	1010-1-8-OR	5/8	3/4	2.06	0.87	1.66	.56	1.49	1-1/2	2-215
12-8 ZHBF5	12M3SC8	1210-1-8-OR	3/4	1/2	1.98	0.87	1.58	.53	1.30	1-3/8	2-212
12-12 ZHBF5	12M3SC12	1210-1-12-OR	3/4	3/4	2.06	0.87	1.66	.56	1.49	1-1/2	2-215
16-12 ZHBF5	16M3SC12	1610-1-12-OR	1	3/4	2.24	1.05	1.75	.56	1.49	1-1/2	2-215
16-16 ZHBF5	16M3SC16	1610-1-16-OR	1	1	2.40	1.05	1.91	.66	1.74	1-3/4	2-219

NOTE: A and C dimensions are typical finger-tight.

Dimensions for reference only, subject to change.

Parts are supplied with nitrile o-rings as standard. For Fluorocarbon o-rings, add the suffix "-VO". Other o-rings available upon request.

Tube End to O-Ring Straight Thread For fractional tube

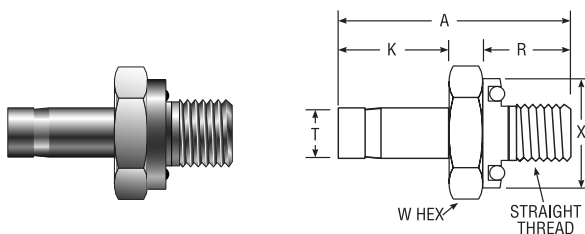

CPI™ PART NO.	A-LOK® PART NO.	INTER- CHANGES WITH	INCHES							O-RING ARP UNIFORM DASH NO.
			T TUBE O.D.	NPT PIPE THREAD	A	K	R	X DIA.	W HEX	
2-2 T2HOA5	2M2TU2	2-TA-OR-ST	1/8	5/16-24	1.22	0.53	.34	0.55	9/16	2-011
3-3 T2HOA5	3M2TU3	3-TA-OR-ST	3/16	3/8-24	1.38	0.56	.38	0.62	5/8	2-012
4-4 T2HOA5	4M2TU4	4-TA-OR-ST	1/4	7/16-20	1.55	0.63	.41	0.74	3/4	2-111
5-5 T2HOA5	5M2TU5	5-TA-OR-ST	5/16	1/2-20	1.64	0.66	.44	0.86	7/8	2-112
6-6 T2HOA5	6M2TU6	6-TA-OR-ST	3/8	9/16-18	1.70	0.69	.47	0.93	15/16	2-113
8-8 T2HOA5	8M2TU8	8-TA-OR-ST	1/2	3/4-16	1.95	0.91	.47	1.12	1-1/8	2-116
10-10 T2HOA5	10M2TU10	10-TA-OR-ST	5/8	7/8-14	2.12	0.97	.47	1.30	1-3/8	2-212
12-12 T2HOA5	12M2TU12	12-TA-OR-ST	3/4	1-1/16-12	2.16	0.97	.56	1.49	1-1/2	2-215
16-16 T2HOA5	16M2TU16	16-TA-OR-ST	1	1-5/16-12	2.47	1.22	.56	1.74	1-3/4	2-219

NOTE: Add -Z6 for assembly of nuts and ferrules on the tube stub end. Dimensions for reference only, subject to change.
 Parts are supplied with nitrile o-rings as standard. For Fluorocarbon o-rings, add the suffix "-VO". Other o-rings available upon request.

Tube End to O-Ring Pipe Thread For fractional tube

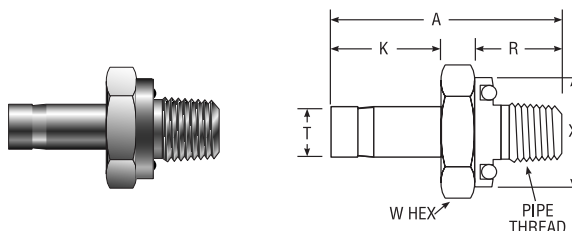

CPI™ PART NO.	A-LOK® PART NO.	INTER- CHANGES WITH	INCHES							O-RING ARP UNIFORM DASH NO.
			T TUBE O.D.	NPT PIPE THREAD	A	K	R	X DIA.	W HEX	
1-2 T2HOF5	1M3TU2	1-TA-1-2OR	1/16	1/8	1.03	0.34	.28	0.74	3/4	2-111
4-2 T2HOF5	4M3TU2	4-TA-1-2OR	1/4	1/8	1.31	0.63	.28	0.74	3/4	2-111
4-4 T2HOF5	4M3TU4	4-TA-1-4OR	1/4	1/4	1.44	0.63	.38	0.93	15/16	2-113
4-6 T2HOF5	4M3TU6	4-TA-1-6OR	1/4	3/8	1.50	0.63	.41	1.12	1-1/8	2-116
5-2 T2HOF5	5M3TU2	5-TA-1-2OR	5/16	1/8	1.34	0.66	.28	0.74	3/4	2-111
5-4 T2HOF5	5M3TU4	5-TA-1-4OR	5/16	1/4	1.47	0.66	.38	0.93	15/16	2-113
6-2 T2HOF5	6M3TU2	6-TA-1-2OR	3/8	1/8	1.38	0.69	.28	0.74	3/4	2-111
6-4 T2HOF5	6M3TU4	6-TA-1-4OR	3/8	1/4	1.50	0.69	.38	0.93	15/16	2-113
6-6 T2HOF5	6M3TU6	6-TA-1-6OR	3/8	3/8	1.59	0.69	.41	1.12	1-1/8	2-116
8-6 T2HOF5	8M3TU6	8-TA-1-6OR	1/2	3/8	1.78	0.91	.41	1.12	1-1/8	2-116
10-8 T2HOF5	10M3TU8	10-TA-1-8OR	5/8	1/2	2.14	0.97	.53	1.30	1-3/8	2-212
12-12 T2HOF5	12M3TU12	12-TA-1-12OR	3/4	3/4	2.16	0.97	.56	1.49	1-1/2	2-215
16-16 T2HOF5	16M3TU16	16-TA-1-16OR	1	1	2.56	1.22	.66	1.65	1-3/4	2-219

NOTE: Add -Z6 for assembly of nuts and ferrules on the tube stub end. Dimensions for reference only, subject to change.
 Parts are supplied with nitrile o-rings as standard. For Fluorocarbon o-rings, add the suffix "-VO". Other o-rings available upon request.

Color Coding

For easy reference, table column headings are color indicated as follows:

fractional



metric



**NPT Thread to SAE
 Straight Thread Adapter**
For fractional tube

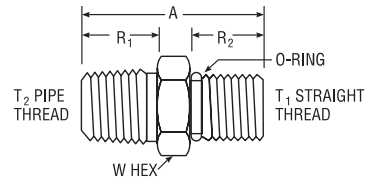
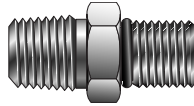

CPI™ PART NO.	A-LOK® PART NO.	INTER- CHANGES WITH	INCHES						O-RING AS UNIFORM DASH NO.
			T ₂ NPT THREAD	T ₁ SAE STRAIGHT THREAD	A	R1	R2	W HEX	
4-4 FHOA	4-4 FHOA	4-SAE-1-4	1/4-18	7/16-20	1.20	.56	.36	9/16	3-904
6-6 FHOA	6-6 FHOA	6-SAE-1-6	3/8-18	9/16-18	1.26	.56	.39	11/16	3-906
8-8 FHOA	8-8 FHOA	8-SAE-1-8	1/2-14	3/4-16	1.53	.75	.44	7/8	3-908
12-12 FHOA	12-12 FHOA	12-SAE-1-12	3/4-14	1-1/16-12	1.75	.75	.59	1-1/4	3-912
16-16 FHOA	16-16 FHOA	16-SAE-1-16	1-11-1/2	1-5/16-12	2.00	.94	.59	1-1/2	3-916

NOTE: A and C dimensions are typical finger-tight.

Dimensions for reference only, subject to change.

For use with SAE J.1926/1 port can also be used with MS-16142 port.
 Parts are supplied with nitrile o-rings as standard. For Fluorocarbon o-rings, add the suffix "-VO".
 Other o-rings available upon request.

**Bulkhead to
 Conversion Adapter**
For fractional tube

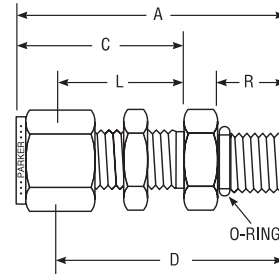
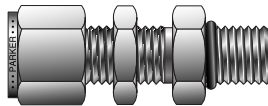

CPI™ PART NO.	A-LOK® PART NO.	INTER- CHANGES WITH	INCHES									
			TUBE O.D.	STRAIGHT THREAD SIZE	A	C	D	R	L	W HEX	BULKHEAD HOLE DRILL SIZE	MAXIMUM BULKHEAD THICKNESS
4-6 AH2BZ	4-6 AH2LZ	400-11-6ST	1/4	9/16-18	1.74	1.17	1.45	.39	.88	3/4	37/64	9/16
6-6 AH2BZ	6-6 AH2LZ	600-11-6ST	3/8	9/16-18	1.81	1.24	1.52	.39	.94	3/4	37/64	9/16

NOTE: A and C dimensions are typical finger-tight.

Dimensions for reference only, subject to change.

For use with SAE J.1926/1 port can also be used with MS-16142 port.
 Parts are supplied with nitrile o-rings as standard. For Fluorocarbon o-rings, add the suffix "-VO".
 Other o-rings available upon request.

Color Coding

For easy reference, table column headings are color indicated as follows:

fractional



metric



General

The weld used in joining a tube to a socket weld tube fitting is like any other type of "tee" weld. The root (i.e., the point of intersection of the outside of the tube and annular end area of the fitting) must be included in the weld zone.

Careful welding procedures are normally followed to assure that this root area is included in the weld. If penetration is not achieved, the joint will have two built-in stress risers which may greatly reduce the strength of the weld. Upon application of an extreme load, these stress risers could result in cracks which could propagate out through the weld or tube depending upon the direction of the greatest load.

Often to achieve full root penetration in TIG welding of stainless steels, a fusion pass will be made first, followed by a final pass utilizing a filler rod to achieve the desired fillet size.

Assembly

The codes applicable to the welding of socket weld fittings require that the tube be inserted into the socket until bottomed against the stop. The tube is then to be backed out approximately 1/16 of an inch and then welded.

If the tube is not backed out, but welded when against a flat bottom stop, the contraction of the weld fillet and fitting socket can combine to produce a static stress on the weld. During thermal transients, the fitting and the portion of the tube within the fitting may experience a differential rate of heating or cooling, again adding to the stress level in the weld.

Tacking

If the weld joint is to be "tacked" before welding, it is recommended that the "Tack" weld build-up be held to a minimum.

Excessive build-up on the "tack" may cause an interrupted final bead and a stress riser or lack of complete fusion.

Backing Gas

Backing gas is an inert gas used to flood the interior of the fittings and tube system during welding. It serves the same purpose internally as the shielding gas used in TIG or MIG welding. By reducing the interior oxygen level to as low as practicable, it also serves to control the combustion of contaminants that could affect weld quality.

When a backing gas is not used and nearly 100% weld penetration is achieved, blisters will tend to form on the internal tube wall. This will result in scale which may later break loose. Therefore, in 0.050 wall or thinner tube or where the wall thickness is such that the selected weld process may burn through, the use of a backing gas is mandatory.

In most cases the backing gas will be argon or helium connected to the system through a control regulator. Flow rates, while small, should be high enough to purge the system. Welds should be made in downstream sequence from the gas connection.

Note that the entire system should be purged to insure that there are no openings that will allow air to be drawn into the system.

The use of backing gas, while often not mandatory, will give a better weld joint. This is because the effects of contaminate combustion by-products are eliminated and because the

welds are made and cooled under a shielded atmosphere, thus eliminating internal scaling or blistering.

Welding Methods 300 Series Stainless Steels

May be welded by the TIG, MIG, or stick arc-weld process.

TIG welding is recommended as being best for welding Weld-lok® systems because it allows better operator control of heat penetration and filler material deposition.

Stick arc welding is not recommended in many cases because of the likelihood of excessive burn-through and improper root penetration. In all cases where stick welding is used, it is recommended that backing gas be used.

MIG welding gives the same characteristics as stick electrode welding with faster deposition of the filler material. As this process runs "hotter" than the stick process, the use of a backing gas is mandatory. It should be noted that in welding the relatively small fitting sizes found in the Weld-lok® line, filler deposition rate economies are not a factor and therefore the MIG method is not commonly applied.

C1018 Steel Fittings

May be welded by the TIG, MIG, stick and oxyacetylene methods. As scale formation remains a problem, the use of a backing gas is still recommended.

Carbide Precipitation

When unstabilized stainless steels are heated to 800° – 1500°F during welding, the chromium in the steel combines with the carbon to form chrome carbides which tend to form along the grain boundaries of the metal (carbide precipitation). This lowers the dissolved chromium content in these areas and thus lowers their corrosion resistance, making them vulnerable to intergranular corrosion. Carbide precipitation is reduced by holding the carbon content of the material to a very low value. This limits the amount of carbon available to combine with the chromium. The "L" series (extra low carbon) stainless steels are often used for this purpose, but their use reduces system design stress by approximately 15%. Parker Weld-lok® fittings are made from a select 316 series with carbon content in the low range of 0.04 to 0.07 percent. This results in a welded fitting with good corrosion resistance and a high strength factor.

All Parker Weld-lok® fittings in stainless steel are supplied in the solution treated condition, capable of passing ASTM-A-262 Tests for Detecting Susceptibility to Intergranular Corrosion.

Arc Polarity

When welding Weld-lok® fittings, best results will be obtained by the following arc polarities:

- TIG – Direct Current, straight polarity
- MIG – Direct Current, reverse polarity
- STICK – Polarity dependent on rod used

For further information on Parker's Welded Fittings refer to Parker's Welded Fittings Catalog 4280 or contact Parker's Instrumentation Products Division – Product Engineering at 256-881-2040.

Socket Weld Elbow

For fractional tube

- for CPI™/A-LOK® to tubing socket weld connection

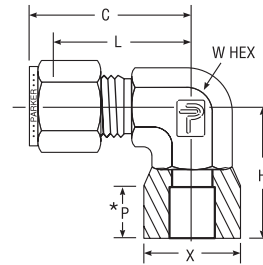
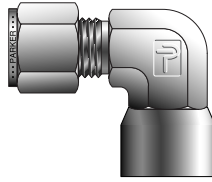

CPI™ PART NO.	A-LOK® PART NO.	INTER- CHANGES WITH	INCHES						
			TUBE O.D.	C	L	H	P*	X	W HEX
2-2 ZEBW	2-2 ZELW	200-9-2 W	1/8	0.92	0.66	0.63	.16	.38	5/16
3-3 ZEBW	3-3 ZELW	300-9-3 W	3/16	0.98	0.72	0.69	.20	.44	7/16
4-4 ZEBW	4-4 ZELW	400-9-4 W	1/4	1.06	0.78	0.84	.25	.50	9/16
6-6 ZEBW	6-6 ZELW	600-9-6 W	3/8	1.31	1.02	1.08	.34	.63	3/4
8-8 ZEBW	8-8 ZELW	810-9-8 W	1/2	1.42	1.02	1.14	.41	.76	3/4
10-10 ZEBW	10-10 ZELW	1010-9-10 W	5/8	1.57	1.17	1.35	.49	.94	1-1/16
12-12 ZEBW	12-12 ZELW	1210-9-12 W	3/4	1.57	1.17	1.39	.50	1.09	1-1/16
16-16 ZEBW	16-16 ZELW	1610-9-16 W	1	1.93	1.65	1.84	.56	1.38	1-5/8

NOTE: C dimension is typical finger-tight.

Dimensions for reference only, subject to change.

*Socket Depth

Buttweld Elbow

For fractional tube

- for CPI™/A-LOK® to pipe buttweld connection

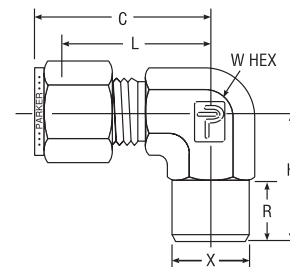
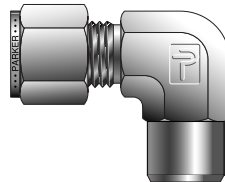

CPI™ PART NO.	A-LOK® PART NO.	INTER- CHANGES WITH	INCHES							
			TUBE O.D.	BUTTWELD PIPE SIZE	C	H	L	R	X BUTTWELD O.D.	W HEX
2-1/8 ZEBW2	2-1/8 ZELW2	200-2-2 W	1/8	1/8	0.93	0.70	0.67	.38	.405	7/16
3-1/8 ZEBW2	3-1/8 ZELW2	300-2-2 W	3/16	1/8	1.01	0.74	0.74	.38	.405	7/16
4-1/8 ZEBW2	4-1/8 ZELW2	400-2-2 W	1/4	1/8	1.06	0.74	0.77	.38	.405	7/16
4-1/4 ZEBW2	4-1/4 ZELW2	400-2-4 W	1/4	1/4	1.10	0.97	0.78	.56	.540	9/16
6-1/4 ZEBW2	6-1/4 ZELW2	600-2-4 W	3/8	1/4	1.20	1.00	0.91	.56	.540	5/8
8-3/8 ZEBW2	8-3/8 ZELW2	810-2-6 W	1/2	3/8	1.42	1.11	1.02	.56	.675	13/16
8-1/2 ZEBW2	8-1/2 ZELW2	810-2-8 W	1/2	1/2	1.42	1.30	1.02	.75	.840	7/8
10-1/2 ZEBW2	10-1/2 ZELW2	1010-2-8 W	5/8	1/2	1.50	1.39	1.10	.75	.840	15/16
12-3/4 ZEBW2	12-3/4 ZELW2	1210-2-12 W	3/4	3/4	1.57	1.45	1.17	.75	1.050	1-1/16
16-3/4 ZEBW2	16-3/4 ZELW2	1610-2-12 W	1	3/4	1.94	1.64	1.45	.75	1.050	1-3/8
16-1 ZEBW2	16-1 ZELW2	1610-2-16 W	1	1	1.94	1.84	1.45	.94	1.315	1-5/16

NOTE: C dimension is typical finger-tight.

Dimensions for reference only, subject to change.

Pipe buttweld end will conform to Schedule 80 unless otherwise noted.

Color Coding

For easy reference, table column headings are color indicated as follows:

fractional



metric



Socket Weld Connector

For fractional tube

- for CPI™ / A-LOK® to tubing socket weld connection

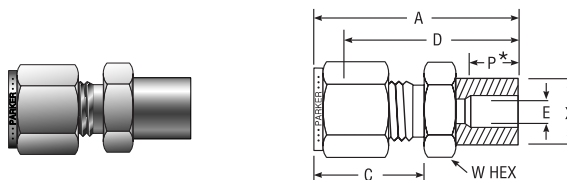

CPI™ PART NO.	A-LOK® PART NO.	INTER- CHANGES WITH	INCHES							
			TUBE O.D.	A	C	D	P*	X	E BORE	W HEX
2-2 ZHBW	2-2 ZHLW	200-6-2 W	1/8	1.16	0.60	0.90	.16	0.38	.094	7/16
3-3 ZHBW	3-3 ZHLW	300-6-3 W	3/16	1.24	0.64	0.98	.20	0.44	.141	1/2
4-4 ZHBW	4-4 ZHLW	400-6-4 W	1/4	1.36	0.70	1.07	.25	0.50	.188	9/16
6-6 ZHBW	6-6 ZHLW	600-6-6 W	3/8	1.53	0.76	1.24	.34	0.63	.313	11/16
8-8 ZHBW	8-8 ZHLW	810-6-8 W	1/2	1.74	0.87	1.34	.41	0.78	.438	13/16
10-10 ZHBW	10-10 ZHLW	1010-6-10 W	5/8	1.86	0.87	1.46	.47	0.94	.500	1
12-12 ZHBW	12-12 ZHLW	1210-6-12 W	3/4	1.92	0.87	1.52	.50	1.09	.656	1-1/8
16-16 ZHBW	16-16 ZHLW	1610-6-16 W	1	2.31	1.05	1.82	.56	1.44	.906	1-5/8

NOTE: A and C dimensions are typical finger-tight.

Dimensions for reference only, subject to change.

See Catalog 4280, Welded Fittings, for additional sizes.

*Socket Depth

Butt Weld Connector

For fractional tube

- for CPI™ / A-LOK® to pipe butt weld connection

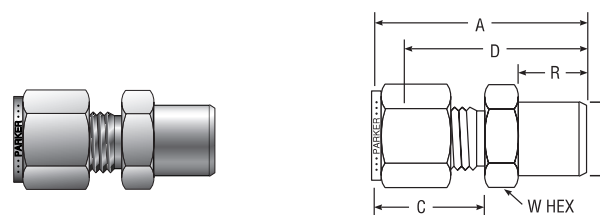

CPI™ PART NO.	A-LOK® PART NO.	INTER- CHANGES WITH	INCHES							
			TUBE O.D.	BUTT WELD PIPE SIZE	A	C	D	R	X BUTT WELD O.D.	W HEX
2-1/8 ZHBW2	2-1/8 ZHLW2	200-1-2 W	1/8	1/8	1.20	0.60	0.94	.38	.405	7/16
3-1/8 ZHBW2	3-1/8 ZHLW2	300-1-2 W	3/16	1/8	1.24	0.64	0.97	.38	.405	7/16
4-1/8 ZHBW2	4-1/8 ZHLW2	400-1-2 W	1/4	1/8	1.29	0.70	1.00	.38	.405	1/2
4-1/4 ZHBW2	4-1/4 ZHLW2	400-1-4 W	1/4	1/4	1.46	0.70	1.17	.56	.540	9/16
5-1/8 ZHBW2	5-1/8 ZHLW2	500-1-2 W	5/16	1/8	1.48	0.73	1.22	.38	.405	1/2
5-1/4 ZHBW2	5-1/4 ZHLW2	500-1-4 W	5/16	1/4	1.49	0.76	1.23	.56	.540	9/16
6-1/4 ZHBW2	6-1/4 ZHLW2	600-1-4 W	3/8	1/4	1.49	0.76	1.20	.56	.540	9/16
6-3/8 ZHBW2	6-3/8 ZHLW2	600-1-6 W	3/8	3/8	1.60	0.76	1.31	.56	.675	3/4
6-1/2 ZHBW2	6-1/2 ZHLW2	600-1-8 W	3/8	1/2	1.82	0.76	1.53	.75	.840	7/8
6-3/4 ZHBW2	6-3/4 ZHLW2	600-1-12 W	3/8	3/4	1.88	0.76	1.59	.75	1.050	1-1/8
8-3/8 ZHBW2	8-3/8 ZHLW2	810-1-6 W	1/2	3/8	1.71	0.87	1.31	.56	.675	13/16
8-1/2 ZHBW2	8-1/2 ZHLW2	810-1-8 W	1/2	1/2	1.93	0.87	1.53	.75	.840	7/8
8-3/4 ZHBW2	8-3/4 ZHLW2	810-1-12 W	1/2	3/4	1.99	0.87	1.59	.75	1.050	1-1/8
10-1/2 ZHBW2	10-1/2 ZHLW2	1010-1-8 W	5/8	1/2	1.93	0.87	1.53	.75	.840	15/16
12-3/4 ZHBW2	12-3/4 ZHLW2	1210-1-12 W	3/4	3/4	1.99	0.87	1.59	.75	1.050	7/8
16-1 ZHBW2	16-1 ZHLW2	1610-1-16 W	1	1	2.46	1.05	1.97	.94	1.310	1-1/16

NOTE: A and C dimensions are typical finger-tight.

Dimensions for reference only, subject to change.

Pipe Butt weld end will conform to Schedule 80 unless otherwise noted.

See Catalog 4280, Welded Fittings, for additional sizes.

Butt Weld Connector

For metric tube

• for CPI™/A-LOK® to pipe
 butt weld connection

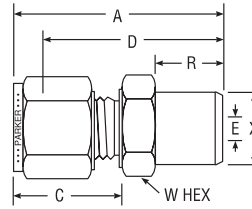
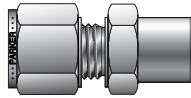

CPI™ PART NO.	A-LOK® PART NO.	INTER- CHANGES WITH	MILLIMETERS								
			TUBE O.D.	BUTT WELD PIPE N.B.	A	C	D	R	X	E BORE	W HEX
ZHBW2 3-1/8	ZHLW2 3-1/8	3MO-1-2W	3	1/8	29,7	15,3	23,1	9,7	10,3	2,4*	12,0
ZHBW2 4-1/8	ZHLW2 4-1/8	4MO-1-2	4	1/8	30,7	16,1	24,1	9,7	10,3	2,4*	12,0
ZHBW2 6-1/8	ZHLW2 6-1/8	6MO-1-2	6	1/8	32,9	17,7	25,4	9,7	10,3	4,8	14,0
ZHBW2 6-1/4	ZHLW2 6-1/4	6MO-1-4W	6	1/4	37,7	17,7	30,2	14,2	13,7	4,8*	14,0
ZHBW2 8-1/8	ZHLW2 8-1/8	8MO-1-2	8	1/8	34,2	18,6	26,7	9,7	10,3	5,1	15,0
ZHBW2 8-1/4	ZHLW2 8-1/4	8MO-1-1/4	8	1/4	38,7	18,6	31,2	14,2	13,7	6,4	15,0
ZHBW2 8-1/2	ZHLW2 8-1/2	8MO-1-8	8	1/2	44,8	18,6	37,3	19,1	21,3	6,4*	22,0
ZHBW2 10-1/4	ZHLW2 10-1/4	–	10	1/4	40,9	19,5	33,3	14,2	13,7	7,1	18,0
ZHBW2 10-3/8	ZHLW2 10-3/8	10MO-1-6	10	3/8	40,1	19,5	32,5	14,2	17,2	7,9*	18,0
ZHBW2 10-1/2	ZHLW2 10-1/2	–	10	1/2	45,7	19,5	38,1	19,1	21,3	7,9*	22,0
ZHBW2 12-1/4	ZHLW2 12-1/4	–	12	1/4	43,4	22,0	33,3	14,2	13,7	7,1	22,0
ZHBW2 12-3/8	ZHLW2 12-3/8	–	12	3/8	43,4	22,0	33,3	14,2	17,2	9,5	22,0
ZHBW2 12-1/2	ZHLW2 12-1/2	12MO-1-8W	12	1/2	48,2	22,0	38,1	19,1	21,3	9,5*	22,0
ZHBW2 15-1/2	ZHLW2 15-1/2	–		1/2	48,2	22,0	38,9	19,1	21,3	9,5*	24,0
ZHBW2 16-1/2	ZHLW2 16-1/2	–	16	1/2	49,0	22,0	38,9	19,1	21,3	12,7*	24,0
ZHBW2 18-1/2	ZHLW2 18-1/2	–	18	1/2	50,5	22,0	40,4	19,1	21,3	13,5	27,0

NOTE: *E dimension is minimum opening.
 Fittings of this group may be back-drilled to larger I.D. at pipe end.
 A and C dimensions are typical finger-tight.
 Pipe Butt weld end will conform to Schedule 80 unless otherwise noted.

Dimensions for reference only, subject to change.

Color Coding

For easy reference, table
 column headings are color
 indicated as follows:

fractional



metric



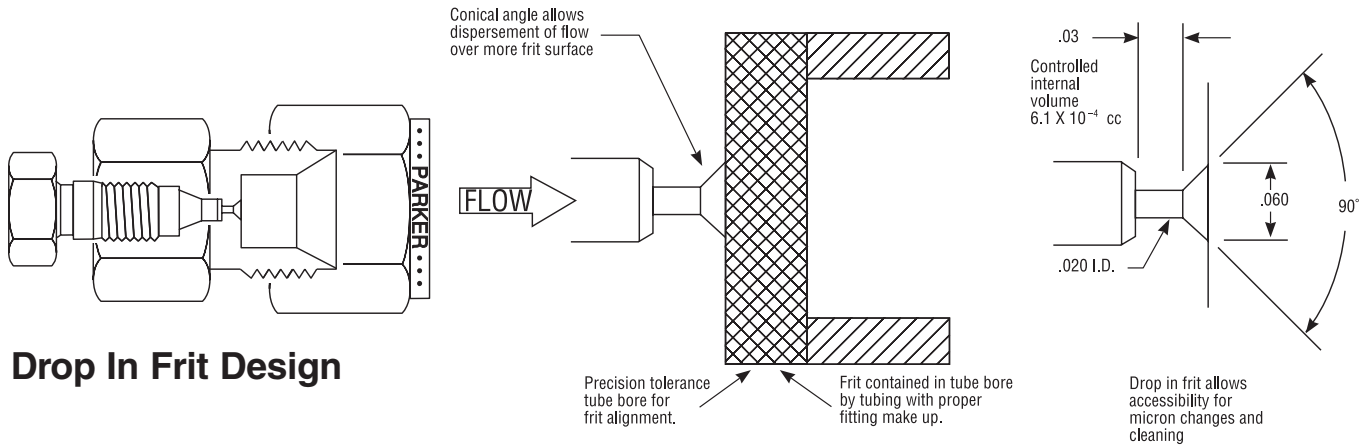

Drop In Frit Design

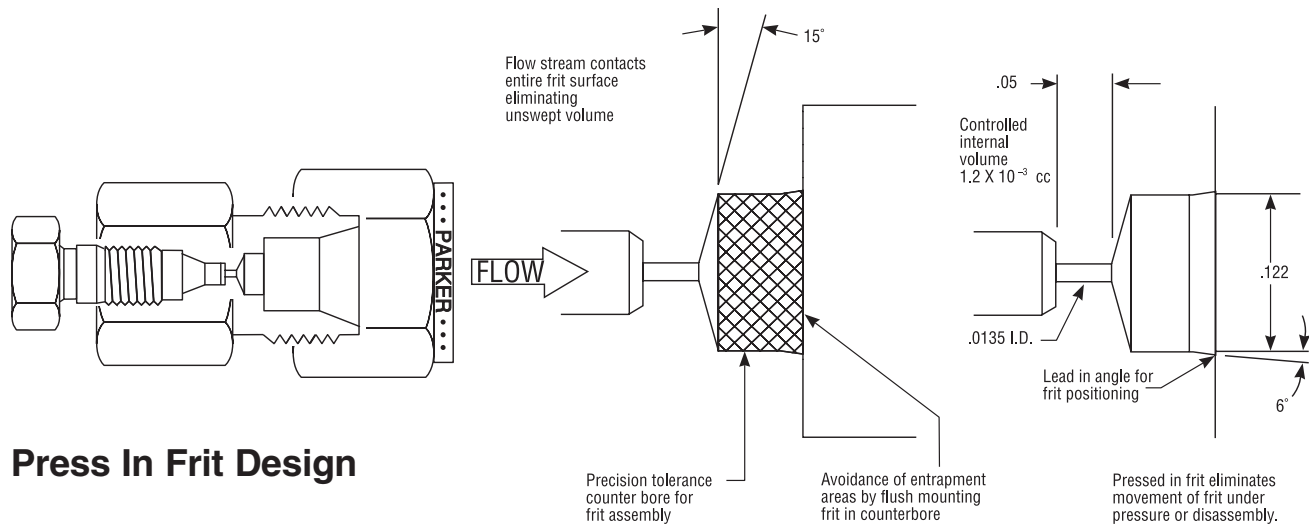

Press In Frit Design

Parker Hannifin's Instrumentation Products Division offers a full line of analytical tube fittings. These fittings range from elbows, tees, and male connectors to low dead volume unions and column end fittings. Parker incorporates various features in the column end fittings to effectively address various industry concerns.

- Peak symmetry for critical analysis
- Internal volume reduction

As the observed media/substance migrates through the HPLC column, a "peak" or "band" is created that denotes the level of concentration. It is critical to maintain peak symmetry in order to get an accurate reading when processing the observed media/substance. Parker Hannifin, in the development of a line of column end fittings, has incorporated some key features that help to maintain this "peak symmetry" in HPLC columns.

"Under most circumstances in liquid chromatography (LC), the flow through the tube is laminar, the so-called Poiseuille flow, and in this situation the velocity at all points is parallel to the tube axis."

Due to the importance of maintaining smooth laminar flow after injection of the sample into the HPLC column, Parker

incorporated a small conical angle on the fitting body internals. This conical angle helps to equally disperse the sample into the column tube. One of the key requirements of an effective column end fitting is not to delay or disturb the flow of the sample through the instrument (HPLC column).

A second area to address is the minimizing of tube fitting internal "cavities". A cavity is a short section of the flow path where the flow-channel diameter increases. It can occur where tubes are connected to each other (low dead volume connector) or to injectors, columns (column end fittings), and detectors. Large cavities can seriously degrade the resolution of any chromatogram, but they can be easily avoided through awareness of the geometric design details of the fittings and connecting parts manufactured by various companies.

Parker Hannifin has incorporated those critical features in both a low dead volume union connector and the column end fitting bodies. First, the utilization of inverted 1/16" connections to greatly reduce internal volume or cavities. To eliminate any confusion or occurrence of incorrect effective tube make-up, the port depths (body bore dimensions) are identical by size throughout the entire Parker Hannifin instrumentation line. Second, Parker closely monitors the dimensions of the small through-hole utilized in these low dead volume connectors.

Column End Fitting – Low Internal Volume with Frit

For fractional tube

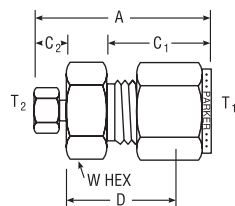
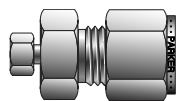

CPI™ PART NO.	A-LOK® PART NO.	INCHES							INTERNAL VOLUME
		T ₁ TUBE O.D.	T ₂ TUBE O.D.	A	C	D	W HEX	INTERNAL OPENING	
2-1 Z2HCZ7	2-1 Z2HLZ7	1/8	1/16	1.25	.60	.78	7/16	.013	5.4 x 10-4cc
4-1 Z2HCZ7	4-1 Z2HLZ7	1/4	1/16	1.35	.70	.84	1/2	.013	1.2 x 10-3cc
6-1 Z2HCZ7	6-1 Z2HLZ7	3/8	1/16	1.43	.76	.92	5/8	.013	3.8 x 10-3cc

NOTE: A and C dimensions are typical finger-tight.

Dimensions for reference only, subject to change.

FRIT DESIGNATOR	
* MICRON DASH NO.	MICRON SIZE
-1	0.5 μ
-2	2 μ
-3	5 μ
-4	10

HOW TO ORDER
EXAMPLE: 4-1Z2HLZ7-2*-SS To order with 2μ frit for 1/4" O.D. column

Features:

- Inverted 1/16" end substantially reduces internal volume
- Flow stream contacts entire frit surface reducing plugging and eliminating unswept volume
- Can be used as a low volume final filter

Column End Fitting – Low Internal Volume

For fractional tube

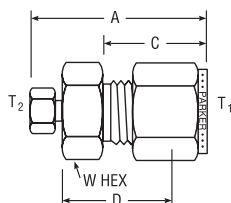
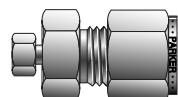

CPI™ PART NO.	A-LOK® PART NO.	INCHES							INTERNAL VOLUME
		T ₁ TUBE O.D.	T ₂ TUBE O.D.	A	C	D	W HEX	INTERNAL OPENING	
4-1 Z3HCZ7	4-1 Z3HLZ7	1/4	1/16	1.28	0.70	0.77	1/2	.020	6.1 x 10-4cc
6-1 Z3HCZ7	6-1 Z3HLZ7	3/8	1/16	1.37	0.76	0.86	5/8	.020	8.1 x 10-4cc
8-1 Z3HCZ7	8-1 Z3HLZ7	1/2	1/16	1.62	0.87	1.00	13/16	.030	2.8 x 10-3cc
16-1 Z3HCZ7	16-1 Z3HLZ7	1	1/16	2.00	1.05	1.31	1-3/8	.030	2 x 10-2cc

NOTE: A and C dimensions are typical finger-tight.

Dimensions for reference only, subject to change.

Features:

- Inverted 1/16" end substantially reduces internal volume
- Drop in frit for use with L.C.* columns or G.C.* columns
- Conical angle below frit directs flow over more frit surface
- Available for up to 1" columns

*G.C. = Gas Chromatograph
 L.C. = Liquid Chromatograph

Di-Frit (drop in)

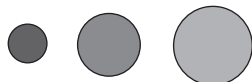

Replaceable frit for preparatory column end fitting Z3HLZ7. Frits are available in 2, 5 and 10 micron sizes.

CPI™/ A-LOK® PARKER PART NO.	MICRON SIZE	COLUMN O.D.
4 DI FRIT-5MIC-SS	5	1/4"
4 DI FRIT-10MIC-SS	10	1/4"
6 DI FRIT-2MIC-SS	2	3/8"
6 DI FRIT-5MIC-SS	5	3/8"
6 DI FRIT-10MIC-SS	10	3/8"

PARKER PART NO.	MICRON SIZE	COLUMN O.D.
8 DI FRIT-5MIC-SS	5	1/2"
8 DI FRIT-10MIC-SS	10	1/2"
16 DI FRIT-2MIC-SS	2	1"
16 DI FRIT-5MIC-SS	5	1"
16 DI FRIT-10MIC-SS	10	1"

Color Coding

For easy reference, table column headings are color indicated as follows:

fractional



metric



Column End Fitting – Low Internal Volume (without Frit) For fractional tube

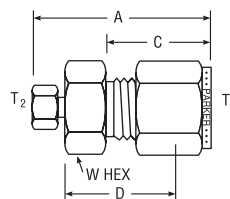
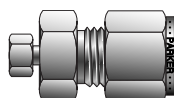

CPI™ PART NO.	A-LOK® PART NO.	INTER- CHANGES WITH	INCHES							INTERNAL OPENING	INTERNAL VOLUME
			T ₁ TUBE O. D.	T ₂ TUBE O. D.	A	C	D	W HEX			
2-1 ZHCZ7	2-1 ZHLZ7	-200-6-1-FGC	1/8	1/16	1.16	.60	.70	7/16	.013	1.0 x 10 ⁻⁴ cc	
4-1 ZHCZ7	4-1 ZHLZ7	-400-6-1-FGC	1/4	1/16	1.24	.70	.77	1/2	.013	1.1 x 10 ⁻⁴ cc	
6-1 ZHCZ7	6-1 ZHLZ7	-600-6-1-FGC	3/8	1/16	1.35	.76	.86	5/8	.013	1.3 x 10 ⁻⁴ cc	

NOTE: A and C dimensions are typical finger-tight.

Dimensions for reference only, subject to change.

Features:

- Inverted 1/16" end substantially
- No frit for use with G.C.* columns or L.C.* columns with screens
- Can be used as a low volume reducing union

*G.C. = Gas Chromatograph
 L.C. = Liquid Chromatograph

Column End Fitting – with Frit For fractional tube

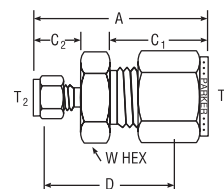
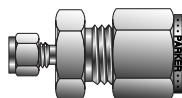

CPI™ PART NO.	A-LOK® PART NO.	T ₁ TUBE O. D.	T ₂ TUBE O. D.	INCHES					INTERNAL OPENING	INTERNAL VOLUME
				A	C1	C2	D	W HEX		
2-1 Z2HCZ	2-1 Z2HLZ	1/8	1/16	1.21	.60	.43	.81	7/16	.020	2.1 x 10 ⁻³ cc
4-1 Z2HCZ	4-1 Z2HLZ	1/4	1/16	1.35	.70	.43	.91	1/2	.020	1.8 x 10 ⁻³ cc
6-1 Z2HCZ	6-1 Z2HLZ	3/8	1/16	1.44	.76	.43	1.00	5/8	.020	5.4 x 10 ⁻³ cc

NOTE: A and C dimensions are typical finger-tight.

Dimensions for reference only, subject to change.

FRIT DESIGNATOR	
* MICRON DASH NO.	MICRON SIZE
-1	0.5μ
-2	2.0μ
-3	5.0μ
-4	10.0μ

HOW TO ORDER
EXAMPLE: 4-1Z2HLZ-2*-SS To order with 2μ frit for 1/4" O.D. column

NOTE: Size 1 not silver-plated.

Features:

- Flow stream contacts entire frit surface reducing plugging and eliminating unswept volume
- Can be used as a low volume final filter with drop-in frit

**Column End Fitting –
 (without Frit)
 For fractional tube**

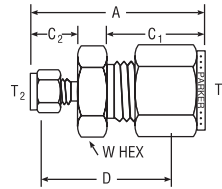
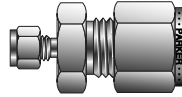

CPI™ PART NO.	A-LOK® PART NO.	INTER- CHANGES WITH	INCHES								INTERNAL OPENING	INTERNAL VOLUME
			T ₁ TUBE O. D.	T ₂ TUBE O. D.	A	C ₁	C ₂	D	W HEX			
2-1 ZHCZ	2-1 ZHLZ	200-6-1LV	1/8	1/16	1.21	.60	.43	0.81	7/16	.020	2.1 x 10-3cc	
4-1 ZHCZ	4-1 ZHLZ	400-6-1LV	1/4	1/16	1.35	.70	.43	0.91	1/2	.020	2.1 x 10-3cc	
6-1 ZHCZ	6-1 ZHLZ	600-6-1LV	3/8	1/16	1.44	.76	.43	1.00	5/8	.020	2.3 x 10-3cc	

NOTE: A and C dimensions are typical finger-tight.

Dimensions for reference only, subject to change.

Size 1 Nut is not silver plated

**Union Connector –
 Low Dead Volume
 For fractional tube**

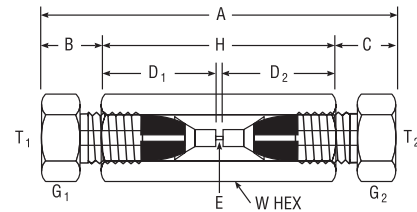

CPI™ PART NO.	A-LOK® PART NO.	INTER- CHANGES WITH	INCHES											INTERNAL VOLUME	
			T ₁ TUBE O. D.	T ₂ TUBE O. D.	†A	†B	†C	D ₁	D ₂	E INTERNAL OPENING	G ₁	G ₂	H		W HEX
1-1 Z7HBZ7-SS	1-1 Z7HLZ7	IFO-6GC	1/16	1/16	1.26	.21	.21	.41	.41	.013	.25	.25	.84	1/4	8.7 x 10-5cc
2-1 Z7HBZ7-SS	2-1 Z7HLZ7	–	1/8	1/16	1.53	.31	.21	.56	.41	.013	.38	.25	1.02	7/16	8.7 x 10-5cc
2-2 Z7HBZ7-SS	2-2 Z7HLZ7	–	1/8	1/8	1.81	.31	.31	.56	.56	.052	.38	.38	1.19	7/16	9.7 x 10-2cc

†Average Value

Dimensions for reference only, subject to change.

Color Coding

For easy reference, table column headings are color indicated as follows:

fractional



metric



**Male Connector –
 Low Dead Volume**
For fractional tube

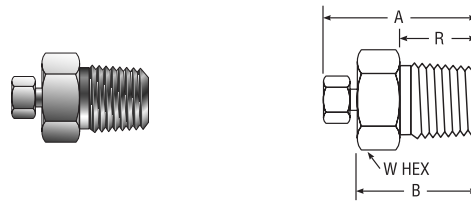

CPI™ PART NO.	A-LOK® PART NO.	INCHES							INTERNAL OPENING	INTERNAL VOLUME
		NPT TUBE O. D.	PIPE THREAD	†A	B	R	W HEX			
1-1 FBZ7	1-1 FLZ7	1/16	1/16	.75	.55	.38	5/16	.013	3.1 x 10-4cc	
1-2 FBZ7	1-2 FLZ7	1/16	1/8	.79	.59	.38	7/16	.013	4.4 x 10-4cc	
1-4 FBZ7	1-4 FLZ7	1/16	1/4	1.01	.81	.56	5/8	.013	8.8 x 10-4cc	

†Average Value

Dimensions for reference only, subject to change.

**Sanitary Flange
 Fitting**
For fractional tube

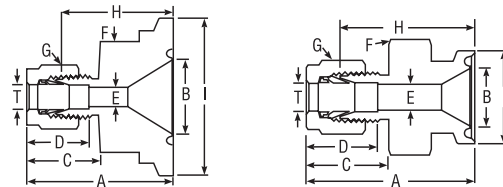

CPI™ PART NO.	A-LOK® PART NO.	INTER- CHANGES WITH	INCHES										
			TUBE O. D.	SANITARY FLANGE	A	B	C	D	E MIN. OPENING	F	G HEX FLAT	H	I
4-8 ZHBS	4-8 ZHLS-SS	SS-400-SC-8	1/4	1/2	1.57	.37	.70	.60	.19	1.00	9/16	1.34	.98
4-12 ZHBS	4-12 ZHLS-SS	SS-400-SC-12	1/4	3/4	1.57	.62	.70	.60	.19	1.00	9/16	1.34	.98
4-16 ZHBS	4-16 ZHLS-SS	SS-400-SC-16	1/4	1	1.57	.87	.70	.60	.19	1.38	9/16	1.34	1.98
4-24 ZHBS	4-24 ZHLS-SS	SS-400-SC-24	1/4	1 1/2	1.57	1.37	.70	.60	.19	1.38	9/16	1.28	1.98
6-8 ZHBS	6-8 ZHLS-SS	SS-600-SC-8	3/8	1/2	1.63	.37	.76	.66	.28	1.00	11/16	1.34	.98
6-12 ZHBS	6-12 ZHLS-SS	SS-600-SC-12	3/8	3/4	1.63	.62	.76	.66	.28	1.00	11/16	1.34	.98
6-16 ZHBS	6-16 ZHLS-SS	SS-600-SC-16	3/8	1	1.63	.87	.76	.66	.28	1.38	11/16	1.34	1.98
6-24 ZHBS	6-24 ZHLS-SS	SS-600-SC-24	3/8	1 1/2	1.63	1.37	.76	.66	.28	1.38	11/16	1.34	1.98
8-8 ZHBS	8-8 ZHLS-SS	SS-810-SC-8	1/2	1/2	1.74	.37	.90	.86	.37	1.00	7/8	1.40	.98
8-12 ZHBS	8-12 ZHLS-SS	SS-810-SC-12	1/2	3/4	1.74	.62	.90	.86	.41	1.00	7/8	1.34	.98
8-16 ZHBS	8-16 ZHLS-SS	SS-810-SC-16	1/2	1	1.74	.87	.90	.86	.41	1.38	7/8	1.34	1.98
8-24 ZHBS	8-24 ZHLS-SS	SS-810-SC-24	1/2	1 1/2	1.74	1.37	.90	.86	.41	1.38	7/8	1.34	1.98

NOTE: A, C, and D dimensions are typical finger tight.

Dimensions for reference only, subject to change.

Sanitary flange fittings combine the reliability and versatility of Parker tube fittings with conventional sanitary flanges. The fittings permit direct downstream connections for hookups and sampling.

Flange sizes are 1/2, 3/4, 1, and 1-1/2 in.

Parker tube fitting ends are available in 1/4, 3/8, and 1/2 in. Parker tube fittings allow use of a variety of tubing materials including metal, hard plastic, and soft plastic.

For a Thermocouple/"Bored-Thru" version of the above Sanitary Adapter fittings, add a "4" to the part number. Example: A 4-12 ZHLS-SS becomes a 4-12 ZH4LS-SS for a 3/4" Sanitary Flange with a 1/4" diameter bored through on the A-LOK® fitting end.

For the full line of Sanitary Fittings and Flow Components, see Catalog 4270-Sanitary/ASME-BPE Fittings.

Barbed Connector to Male Pipe

For fractional tube

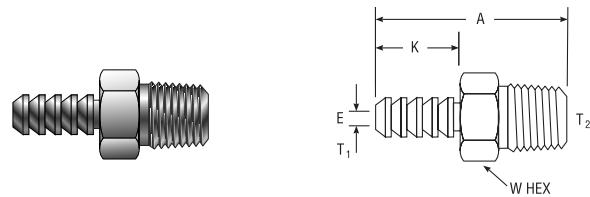

CPI™ PART NO.	A-LOK® PART NO.	INTER- CHANGES WITH	INCHES					
			T HOSE I.D.	T ₂ MALE PIPE SIZE	A	E BORE	K	W HEX
2-2 B2HF	2-2 B2HF	2-HC-1-2	1/8	1/8	1.00	.078	0.41	7/16
2-4 B2HF	2-4 B2HF	2-HC-1-4	1/8	1/4	1.22	.078	0.41	9/16
4-2 B2HF	4-2 B2HF	4-HC-1-2	1/4	1/8	1.41	.188	0.75	7/16
4-4 B2HF	4-4 B2HF	4-HC-1-4	1/4	1/4	1.59	.188	0.78	9/16
5-2 B2HF	5-2 B2HF	5-HC-1-2	5/16	1/8	1.50	.188	0.88	7/16
5-4 B2HF	5-4 B2HF	5-HC-1-4	5/16	1/4	1.69	.250	0.88	9/16
6-4 B2HF	6-4 B2HF	6-HC-1-4	3/8	1/4	1.72	.281	0.88	9/16
6-6 B2HF	6-6 B2HF	6-HC-1-6	3/8	3/8	1.72	.297	0.88	11/16
8-6 B2HF	8-6 B2HF	8-HC-1-6	1/2	3/8	1.81	.375	0.94	3/4
8-8 B2HF	8-8 B2HF	8-HC-1-8	1/2	1/2	2.00	.375	0.94	7/8
12-12 B2HF	12-12 B2HF	12-HC-1-12	3/4	3/4	2.13	.625	1.03	1-1/16

Dimensions for reference only, subject to change.

Barbed Connector to Tube Adapter

For fractional tube

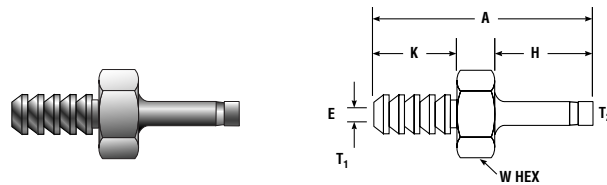

CPI™ PART NO.	A-LOK® PART NO.	INTER- CHANGES WITH	INCHES						
			T ₁ TUBE I.D.	T ₂ TUBE O.D.	A	E BORE	H	K	W HEX
2-2 B2HT2	2B2TU2	2-HC-A-201	1/8	1/8	1.16	.078	.53	.41	5/16
2-4 B2HT2	2B2TU4	2-HC-A-401	1/8	1/4	1.26	.078	.64	.41	3/8
4-4 B2HT2	4B2TU4	4-HC-A-401	1/4	1/4	1.64	.156	.64	.78	3/8
6-6 B2HT2	6B2TU6	6-HC-A-601	3/8	3/8	1.75	.156	.72	.78	7/16

Dimensions for reference only, subject to change.

NOTE: Tube adapter end is designed for use with Parker fittings or valves. Simply insert the tube adapter end until it bottoms and tighten the Parker nut 3/4 turns for sizes 3 and below, for sizes 4 and above 1-1/4 turns from finger tight.

Add -Z6 for assembly of nuts and ferrules on the tube stub end.

Hose Connector Sleeve

For fractional tube



PARKER PART NO.	INCHES			
	HOSE I.D.	HOSE O.D.	L	W HEX
HCS 2-4	1/8	1/4	0.41	3/8
HCS 4-6	1/4	3/8	0.78	9/16
HCS 4-7	1/4	7/16	0.78	5/8
HCS 4-8	1/4	1/2	0.78	11/16
HCS 4-9	1/4	9/16	0.78	3/4
HCS 5-7	5/16	7/16	0.88	5/8
HCS 6-8	3/8	1/2	0.88	11/16
HCS 6-9	3/8	9/16	0.88	3/4
HCS 8-11	1/2	11/16	0.94	7/8
HCS 12-16	3/4	1	1.06	1-1/4

Dimensions for reference only, subject to change.

Color Coding

For easy reference, table column headings are color indicated as follows:

fractional



metric



Insert
 For fractional tube

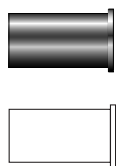

PARKER PART NO.	INTER-CHANGES WITH	INCHES		
		TUBE O.D.	TUBE I.D.	TUBE WALL
3 TIZ .125	305-2	3/16	.125	.031
4 TIZ .125	405-2	1/4	.125	.062
4 TIZ .170	405-170	1/4	.170	.040
4 TIZ .188	405-3	1/4	.188	.031
5 TIZ .125	505-2	5/16	.125	.094
5 TIZ .188	505-3	5/16	.188	.062
5 TIZ .250	505-4	5/16	.250	.031
6 TIZ .188	605-3	3/8	.188	.094
6 TIZ .250	605-4	3/8	.250	.062
8 TIZ .250	815-4	1/2	.250	.125
8 TIZ .375	815-6	1/2	.375	.062
10 TIZ .375	1015-6	5/8	.375	.125
10 TIZ .500	1015-8	5/8	.500	.062
12 TIZ .500	1215-8	3/4	.500	.125
12 TIZ .625	1215-10	3/4	.625	.062
16 TIZ .750	1615-12	1	.750	.125
16 TIZ .875	1615-14	1	.875	.062

Dimensions for reference only, subject to change.

NOTE: Tubing wall thickness and corresponding minimum I.D. flow paths are listed so the system designer can properly match the insert to the tubing.

Example: 4 TIZ .125 is used with tubing having a wall thickness of .062 and I.D. of .125.

Insert
 For metric tube

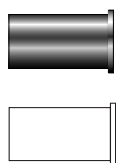

PARKER PART NO.	INTER-CHANGES WITH	MILLIMETERS		
		TUBE O.D.	TUBE I.D.	TUBE WALL
TIZ 6 (4)	6M5-4M	6	4	1,0
TIZ 8 (6)	8M5-6M	8	6	1,0
TIZ 10 (6)	10M5-6M	10	6	2,0
TIZ 10 (8)	10M5-8M	10	8	1,0
TIZ 12 (8)	12M5-8M	12	8	2,0
TIZ 12 (10)	12M5-10M	12	10	1,0
TIZ 15 (10)	15M5-10M	15	10	2,5

Dimensions for reference only, subject to change.

NOTE: Tubing wall thickness and corresponding minimum I.D. flow paths are listed so the system designer can properly match the insert to the tubing.

Example: TIZ 6 (4) is used with tubing having a wall thickness of 1mm and I.D. of 4mm.

TIZ inserts allow CPI™/A-LOK® fittings to be used with soft plastic tubing.

Tube Nut
 For fractional tube

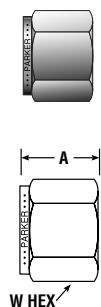

CPI™ PART NO.	A-LOK® PART NO.	INTER-CHANGES WITH	INCHES		
			TUBE O.D.	A	W HEX
1 BZ	1NU1	102-1	1/16	0.31	5/16
2 BZ	2NU2	202-1	1/8	0.47	7/16
3 BZ	3NU3	302-1	3/16	0.47	1/2
4 BZ	4NU4	402-1	1/4	0.50	9/16
5 BZ	5NU5	502-1	5/16	0.53	5/8
6 BZ	6NU6	602-1	3/8	0.56	11/16
8 BZ	8NU8	812-1	1/2	0.69	7/8
10 BZ	10NU10	1012-1	5/8	0.69	1
12 BZ	12NU12	1212-1	3/4	0.69	1-1/8
14 BZ	14NU14	1412-1	7/8	0.69	1-1/4
16 BZ	16NU16	1612-1	1	0.81	1-1/2
20 BZ	20NU20	2012-1	1-1/4	1.25	1-7/8
24 BZ	24NU24	2412-1	1-1/2	1.50	2-1/4
32 BZ	32NU32	3212-1	2	2.06	3

Dimensions for reference only, subject to change.

NOTE: All size 20, 24 and 32 silver plated nuts should have a system compatible lube (Permatex Anti-seize – Parker Catalog 4290-INST) or equivalent applied to the fitting body threads and the inside back of nuts. This will minimize the effort required to assemble the fitting properly.

Tube Nut For metric tube

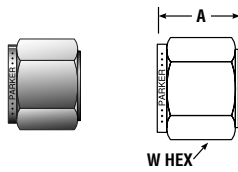

CPI™ PART NO.	A-LOK® PART NO.	INTER- CHANGES WITH	UN THREAD	MILLIMETERS		
				TUBE O.D.	A	W HEX
BZ 2	NUM2	2M2-1	5/16-20	2	11,9	12,0
BZ 3	NUM3	3M2-1	5/16-20	3	11,9	12,0
BZ 4	NUM4	4M2-1	3/8-20	4	11,9	12,0
BZ 6	NUM6	6M2-1	7/16-20	6	12,7	14,0
BZ 8	NUM8	8M2-1	1/2-20	8	13,5	16,0
BZ 10	NUM10	10M2-1	5/8-20	10	15,1	19,0
BZ 12	NUM12	12M2-1	3/4-20	12	17,5	22,0
BZ 14	NUM14	14M2-1	7/8-20	14	17,5	25,0
BZ 15	NUM15	15M2-1	7/8-20	15	17,5	25,0
BZ 16	NUM16	16M2-1	7/8-20	16	17,5	25,0
BZ 18	NUM18	18M2-1	1-20	18	17,5	30,0
BZ 20	NUM20	20M2-1	1.1/8-20	20	17,5	32,0
BZ 22	NUM22	22M2-1	1.1/8-20	22	17,5	32,0
BZ 25	NUM25	25M2-1	1.5/16-20	25	20,6	38,0

Dimensions for reference only, subject to change.

Inverted Tube Nut For fractional tube

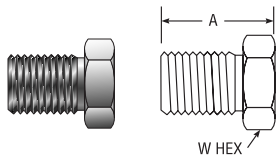

PARKER PART NO.	INTER- CHANGES WITH	INCHES		
		TUBE O.D.	A	W HEX
1 BZI	1F2-1GC	1/16	.39	1/4
2 BZI	2F2-1GC	1/8	.44	7/16

Dimensions for reference only, subject to change.

Knurled Nut For fractional tube

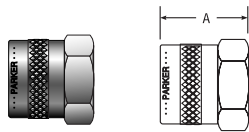

PARKER PART NO.	INTER- CHANGES WITH	INCHES	
		TUBE O.D.	A
1 BZP	102-1K	1/16	.32
2 BZP	202-1K	1/8	.47
3 BZP	302-1K	3/16	.47
4 BZP	402-1K	1/4	.51
5 BZP	502-1K	5/16	.54
6 BZP	812-1K	3/8	.57
8 BZP	602-1K	1/2	.69
10 BZP	1012-1K	5/8	.69

Dimensions for reference only, subject to change.

HOW TO ASSEMBLE BZP

1. Replaces BZ/NU nuts on Parker CPI™/A-LOK® fitting bodies.
2. Insert plastic tubing until it bottoms in fitting body.
3. Tighten finger tight.

The knurled nut is designed for use with soft plastic tubing on low pressure applications where a finger tight assembly procedure is satisfactory.

Example: Laboratory test hook-ups. Nylon or PTFE ferrules are frequently used instead of metal ferrules in this type of application.

Ferrules



Color Coding

For easy reference, table column headings are color indicated as follows:

fractional



metric



PARKER PART NO.	INCHES TUBE O.D.
1 TZ	1/16
2 TZ	1/8
3 TZ	3/16
4 TZ	1/4
5 TZ	5/16
6 TZ	3/8
8 TZ	1/2
10 TZ	5/8
12 TZ	3/4
14 TZ	7/8
16 TZ	1
20 TZ	1-1/4
24 TZ	1-1/2
32 TZ	2

Dimensions for reference only, subject to change.

PARKER PART NO.	MILLIMETER TUBE O.D.
TZ 3	3
TZ 6	6
TZ 8	8
TZ 10	10
TZ 12	12
TZ 16	16
TZ 20	20
TZ 25	25

Dimensions for reference only, subject to change.

Note: Ferrules are available in standard metal materials as well as standard plastics like PTFE and nylon. Please consult the factory for availability.

**INCH
Front Ferrule**
For fractional tube



PARKER PART NO.	INTER-CHANGES WITH	INCHES TUBE O. D.
1FF1	103-1	1/16
2FF2	203-1	1/8
3FF3	303-1	3/16
4FF4	403-1	1/4
5FF5	503-1	5/16
6FF6	603-1	3/8
8FF8	813-1	1/2
10FF10	1013-1	5/8
12FF12	1213-1	3/4
14FF14	1413-1	7/8
16FF16	1613-1	1
20FF20	2013-1	1-1/4
24FF24	2413-1	1-1/2
32FF32	3213-1	2

Note: Ferrules are available in standard metal materials as well as standard plastics like PTFE and nylon. Please consult the factory for availability.

**METRIC
Front Ferrule**
For metric tube



PARKER PART NO.	INTER-CHANGES WITH	MM TUBE O. D.
FFM2	2M3-1	2
FFM3	3M3-1	3
FFM4	4M3-1	4
FFM6	6M3-1	6
FFM8	8M3-1	8
FFM10	10M3-1	10
FFM12	12M3-1	12
FFM14	14M3-1	14
FFM15	15M3-1	15
FFM16	16M3-1	16
FFM18	18M3-1	18
FFM20	20M3-1	20
FFM22	22M3-1	22
FFM25	25M3-1	25

Note: Ferrules are available in standard metal materials as well as standard plastics like PTFE and nylon. Please consult the factory for availability.

**INCH
Back Ferrule**
For fractional tube



For stainless steel, sizes 4-32 are Suparcase ferrules.

PARKER PART NO.	INTER-CHANGES WITH	INCHES TUBE O. D.
1BF1	104-1	1/16
2BF2	204-1	1/8
3BF3	304-1	3/16
4BF4	404-1	1/4
5BF5	504-1	5/16
6BF6	604-1	3/8
8BF8	814-1	1/2
10BF10	1014-1	5/8
12BF12	1214-1	3/4
14BF14	1414-1	7/8
16BF16	1614-1	1
20BF20	2014-1	1-1/4
24BF24	2414-1	1-1/2
32BF32	3214-1	2

Note: Ferrules are available in standard metal materials as well as standard plastics like PTFE and nylon. Please consult the factory for availability.

**METRIC
Back Ferrule**
For metric tube



For stainless steel, sizes 6mm–25mm are Suparcase ferrules.

PARKER PART NO.	INTER-CHANGES WITH	MM TUBE O. D.
BFM2	2M4-1	2
BFM3	3M4-1	3
BFM4	4M4-1	4
BFM6	6M4-1	6
BFM8	8M4-1	8
BFM10	10M4-1	10
BFM12	12M4-1	12
BFM14	14M4-1	14
BFM15	15M4-1	15
BFM16	16M4-1	16
BFM18	18M4-1	18
BFM20	20M4-1	20
BFM22	22M4-1	22
BFM25	25M4-1	25

Note: Ferrules are available in standard metal materials as well as standard plastics like PTFE and nylon. Please consult the factory for availability.

Ferrule Holder

Package simplifies ordering, stocking, and assembling

The Parker ferrule holder offers a new convenience. The holder contains individual ferrule sets. Ferrule sets may be dispensed one at a time.

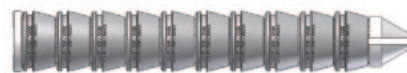

A-LOK® ferrules



CPI™ ferrules

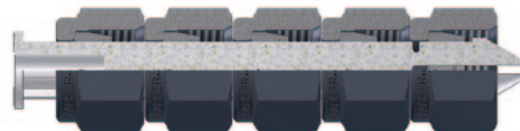

Cross-section of an arbor with five nut ferrule sets

NOTE: Assembled Nut and Ferrule Sets are available. Use designator NFS for the assembly of 5 sets per arbor.

Examples: 4A-NFS-316 (A-LOK® nut and ferrules set)
 4Z-NFS-SS (CPI™ nut and ferrule set)

CPI™ PART NO.	A-LOK® PART NO.	INCHES TUBE O. D.
2 CPI*-SET	2 ALOK*-SET	1/8
4 CPI*-SET	4 ALOK*-SET	1/4
6 CPI*-SET	6 ALOK*-SET	3/8
8 CPI*-SET	8 ALOK*-SET	1/2
12 CPI*-SET	12 ALOK*-SET	3/4
16 CPI*-SET	16 ALOK*-SET	1

*Material designator – 316-SS, B-Brass, S-Steel

CPI™ PART NO.	A-LOK® PART NO.	MM TUBE O. D.
6M CPI*-SET	6M ALOK*-SET	6
8M CPI*-SET	8M ALOK*-SET	8
10M CPI*-SET	10M ALOK*-SET	10
12M CPI*-SET	12M ALOK*-SET	12

*Material designator – 316-SS, B-Brass, S-Steel

Plug

For fractional tube

For plugging open ended CPI™/A-LOK® fitting ends

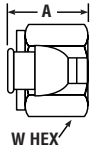

CPI™ PART NO.	A-LOK® PART NO.	INTER- CHANGES WITH	INCHES			
			TUBE O. D.	THREAD	A	W HEX
1 FNZ	1BLP1	100-P	1/16	10-32	0.31	5/16
2 FNZ	2BLP2	200-P	1/8	5/16-20	0.47	7/16
3 FNZ	3BLP3	300-P	3/16	3/8-20	0.47	1/2
4 FNZ	4BLP4	400-P	1/4	7/16-20	0.50	9/16
5 FNZ	5BLP5	500-P	5/16	1/2-20	0.53	5/8
6 FNZ	6BLP6	600-P	3/8	9/16-20	0.56	11/16
8 FNZ	8BLP8	810-P	1/2	3/4-20	0.69	7/8
10 FNZ	10BLP10	1010-P	5/8	7/8-20	0.69	1
12 FNZ	12BLP12	1210-P	3/4	1-20	0.69	1-1/8
14 FNZ	14BLP14	1410-P	7/8	1-1/8-20	0.69	1-1/4
16 FNZ	16BLP16	1610-P	1	1-5/16-20	0.81	1-1/2
20 FNZ	20BLP20	2010-P	1-1/4	1-5/8-20	1.35	1-7/8
24 FNZ	24BLP24	2410-P	1-1/2	1-15/16-20	1.72	2-1/4
32 FNZ	32BLP32	3210-P	2	2-5/8-20	2.27	3

Dimensions for reference only, subject to change.

HOW TO ASSEMBLE

Wrench tighten only 1/4 turn from finger tight position. Assembly includes machined ferrule with lock ring.

Plug

For metric tube

For plugging open ended CPI™/A-LOK® fitting ends

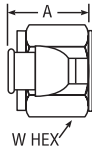

CPI™ PART NO.	A-LOK® PART NO.	INTER- CHANGES WITH	MILLIMETERS			
			TUBE O. D.	THREAD	A	W HEX
FNZ 2	BLPM2	2MO-P	2	5/16-20	11,9	12,0
FNZ 3	BLPM3	3MO-P	3	5/16-20	11,9	12,0
FNZ 4	BLPM4	4MO-P	4	3/8-20	11,9	12,0
FNZ 6	BLPM6	6MO-P	6	7/16-20	12,7	14,0
FNZ 8	BLPM8	8MO-P	8	1/2-20	13,5	16,0
FNZ 10	BLPM10	10MO-P	10	5/8-20	15,1	19,0
FNZ 12	BLPM12	12MO-P	12	3/4-20	17,5	22,0
FNZ 14	BLPM14	14MO-P	14	7/8-20	17,5	25,0
FNZ 15	BLPM15	15MO-P	15	7/8-20	17,5	25,0
FNZ 16	BLPM16	16MO-P	16	7/8-20	17,5	25,0
FNZ 18	BLPM18	18MO-P	18	1-20	17,5	30,0
FNZ 20	BLPM20	20MO-P	20	1-1/8-20	17,5	32,0
FNZ 22	BLPM22	22MO-P	22	1-1/8-20	17,5	32,0
FNZ 25	BLPM25	25MO-P	25	1-5/16-20	20,6	38,0

Dimensions for reference only, subject to change.

HOW TO ASSEMBLE

Wrench tighten only 1/4 turn from finger tight position. Assembly includes machined ferrule with lock ring.

Cap

For fractional tube

For capping open ended tubing

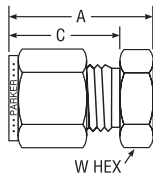
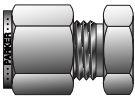

CPI™ PART NO.	A-LOK® PART NO.	INTER- CHANGES WITH	INCHES			
			TUBE O. D.	A	C	W HEX
1 PNBZ	1BLEN1	100-C	1/16	0.56	0.43	5/16
2 PNBZ	2BLEN2	200-C	1/8	0.79	0.60	7/16
3 PNBZ	3BLEN3	300-C	3/16	0.84	0.64	7/16
4 PNBZ	4BLEN4	400-C	1/4	0.92	0.70	1/2
5 PNBZ	5BLEN5	500-C	5/16	0.96	0.73	9/16
6 PNBZ	6BLEN6	600-C	3/8	1.01	0.76	5/8
8 PNBZ	8BLEN8	810-C	1/2	1.15	0.87	13/16
10 PNBZ	10BLEN10	1010-C	5/8	1.18	0.87	15/16
12 PNBZ	12BLEN12	1210-C	3/4	1.25	0.87	1-1/16
14 PNBZ	14BLEN14	1410-C	7/8	1.31	0.87	1-3/16
16 PNBZ	16BLEN16	1610-C	1	1.52	1.05	1-3/8
20 PNBZ	20BLEN20	2010-C	1-1/4	2.09	1.52	1-3/4
24 PNBZ	24BLEN24	2410-C	1-1/2	2.53	1.77	2-1/8
32 PNBZ	32BLEN32	3210-C	2	3.41	2.47	2-3/4

NOTE: For body only specify PNZ.

Dimensions for reference only, subject to change.

A and C dimensions are typical finger-tight.

Cap

For metric tube

For capping open ended tubing

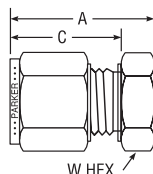
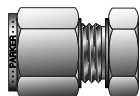

CPI™ PART NO.	A-LOK® PART NO.	INTER- CHANGES WITH	MILLIMETERS			
			TUBE O. D.	A	C	W HEX
PNBZ 2	BLENM2	2MO-C	2	13,5	15,3	12,0
PNBZ 3	BLENM3	3MO-C	3	13,5	15,3	12,0
PNBZ 4	BLENM4	4MO-C	4	14,3	16,1	12,0
PNBZ 6	BLENM6	6MO-C	6	15,9	17,7	14,0
PNBZ 8	BLENM8	8MO-C	8	17,1	18,6	15,0
PNBZ 10	BLENM10	10MO-C	10	19,1	19,5	18,0
PNBZ 12	BLENM12	12MO-C	12	19,1	22,0	22,0
PNBZ 14	BLENM14	14MO-C	14	19,8	22,0	24,0
PNBZ 15	BLENM15	15MO-C	15	19,8	22,0	24,0
PNBZ 16	BLENM16	16MO-C	16	19,8	22,0	24,0
PNBZ 18	BLENM18	18MO-C	18	21,3	22,0	27,0
PNBZ 20	BLENM20	20MO-C	20	23,9	22,0	30,0
PNBZ 22	BLENM22	22MO-C	22	23,9	22,0	30,0
PNBZ 25	BLENM25	25MO-C	25	26,2	26,5	35,0

NOTE: For body only specify PNZ.

Dimensions for reference only, subject to change.

A and C dimensions are typical finger-tight.

Vent Protector NPT Male Pipe Thread

For fractional tube

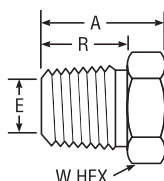

CPI™ PART NO.	INTER- CHANGES WITH	THREAD SIZE	INCHES			
			A	R	E MINIMUM OPENING	W HEX
2 MDF	MS-MD-2M	1/8-27	0.63	.38	.19	9/16
4 MDF	MS-MD-4M	1/4-18	0.81	.56	.28	9/16
6 MDF	MS-MD-6M	3/8-18	0.81	.56	.41	11/16
8 MDF	MS-MD-8M	1/2-14	1.06	.75	.50	7/8
12 MDF	MS-MD-12M	3/4-14	1.13	.75	.63	1-1/16
16 MDF	MS-MD-16M	1-11-1/2	1.31	.95	.94	1-3/8

Dimensions for reference only, subject to change.

Parker Instrumentation vent protectors (mud dauber fittings) protect open ends of instruments, tubing, outlet vents, etc.

The mesh wire screen prevents foreign bodies such as insects or debris from entering and clogging various systems and causing damage.

- pipe plug, bored-thru design
- 40 x 40 mesh, .010 diameter wire screen
- designed to vent female pipe, straights, elbows or tees.

Color Coding

For easy reference, table column headings are color indicated as follows:

fractional



metric



Sealing Washers

Bonded Seals

Consists of an outer stainless steel ring with a fluorocarbon inner ring used to seal a male ISO parallel thread.

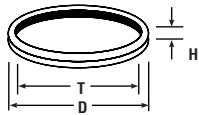

PARKER PART NO.	T BSPP THREAD	D	H
M30201-SS	1/8	0.63	.08
M30202-SS	1/4	0.81	.08
M30203-SS	3/8	0.94	.08
M30204-SS	1/2	1.12	.10
M30206-SS	3/4	1.38	.10
M30208-SS	1	1.69	.10

Simply replace Suffix SS with S

These seals are also available in steel with a nitrile inner ring.

PRESSURE RATINGS FOR SEALING WASHER		
THREAD SIZE	PSI	BAR
1/8	5300	370
1/4	5500	380
3/8	4400	300
1/2	4000	280
3/4	3700	260
1	2800	190

Dimensions for reference only, subject to change.

Copper Washers

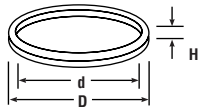

For BSPP male thread sealing

PARKER PART NO.	THREAD	D	D	H
M28329-CU	1/8	0.71	0.39	.09
M28330-CU	1/4	0.87	0.55	.09
M28331-CU	3/8	0.94	0.67	.09
M28332-CU	1/2	1.18	0.87	.10
M28334-CU	3/4	1.38	1.06	.09
M28336-CU	1	1.65	1.34	.09

For BSPP female thread sealing

PARKER PART NO.	THREAD	D	D	H
M25179-CU	1/8	0.322	.188	.062
M25180-CU	1/4	0.436	.250	.062
M25181-CU	3/8	0.574	.375	.062
M25182-CU	1/2	0.719	.500	.062
M25184-CU	3/4	0.935	.719	.062
M25186-CU	1	1.178	.969	.093

Dimensions for reference only, subject to change.

Used to provide a seal with male or female parallel ISO threads.

Please note the pressure ratings are based on taper threaded ends. The pressure rating for the BSPP ends are dependent on the type of sealing washer used.

Color Coding

For easy reference, table column headings are color indicated as follows:

fractional



metric



Bulkhead Locknut For fractional tube

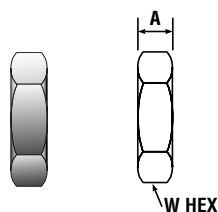

PARKER PART NO.	INTER-CHANGES WITH	INCHES			
		A-LOK® THREAD	TUBE O.D.	A	W HEX
1 WLZ	102-61	10-32	1/16	.13	5/16
2 WLZ	202-61	5/16-20	1/8	.19	1/2
3 WLZ	302-61	3/8-20	3/16	.22	9/16
4 WLZ	402-61	7/16-20	1/4	.22	5/8
5 WLZ	502-61	1/2-20	5/16	.23	11/16
6 WLZ	602-61	9/16-20	3/8	.25	3/4
8 WLZ	812-61	3/4-20	1/2	.28	15/16
10 WLZ	1012-61	7/8-20	5/8	.31	1-1/16
12 WLZ	1212-61	1"-20	3/4	.34	1-3/16
14 WLZ	1412-61	1-1/8-20	7/8	.38	1-3/8
16 WLZ	1612-61	1-5/16-20	1	.38	1-5/8

Dimensions for reference only, subject to change.

Bulkhead Locknut For fractional tube

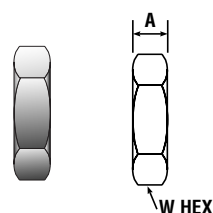

PARKER PART NO.	INCHES			
	SAE ADJ. STR. THREAD	TUBE O.D.	A	W HEX
4 WLN	7/16-20	1/4	.28	11/16
6 WLN	9/16-18	3/8	.27	13/16
8 WLN	3/4-16	1/2	.31	1
12 WLN	1-1/16-12	3/4	.41	1-3/8
16 WLN	1-5/16-12	1	.41	1-5/8

Dimensions for reference only, subject to change.

Bulkhead Locknut For metric tube

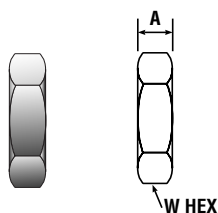

PARKER PART NO.	MILLIMETERS			
	SAE ADJ. STR. THREAD	TUBE O.D.	A	W HEX
2BN2	5/16-20	2 & 3	4,8	13,0
3BN3	3/8-20	4	5,6	14,0
4BN4	7/16-20	6	5,6	16,0
5BN5	1/2-20	8	5,6	17,0
BNM10	5/8-20	10	6,4	21,0
8BN8	3/4-20	12	7,1	24,0
10BN10	7/8-20	14, 15 & 16	7,9	27,0
12BN12	1-20	18	8,6	30,0
14BN14	1-1/8-20	20 & 22	9,7	33,0
16BN16	1-5/16-20	25	9,7	41,0

Dimensions for reference only, subject to change.

Accessory Locknut

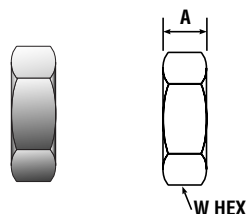

PARKER PART NO.	INCHES		
	STRAIGHT THREAD	A	W HEX
2 L5NR	5/16-24	.22	7/16
3 L5NR	3/8-24	.22	1/2
4 L5NR	7/16-20	.28	9/16
5 L5NR	1/2-20	.28	5/8
6 L5NR	9/16-18	.28	11/16
8 L5NR	3/4-16	.31	7/8
10 L5NR	7/8-14	.36	1
12 L5NR	1-1/16-12	.41	1-1/4
14 L5NR	1-3/16-12	.41	1-3/8
16 L5NR	1-5/16-12	.41	1-1/2

Dimensions for reference only, subject to change.

NOTE: For use with M2SC and M2TU fittings on pages 58 and 59.

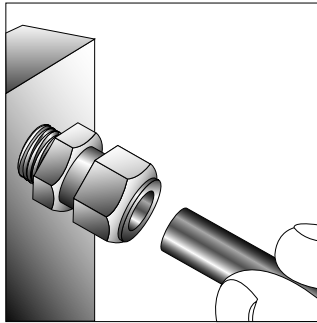

INCH SIZE 1 thru 3
(1/16" - 3/16")
 METRIC SIZE 2 thru 4
(2-4mm)

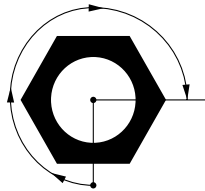

Only 3/4 turn from finger tight is necessary to seal and will result in additional remakes of the fitting

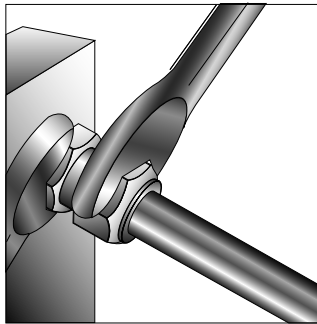

INCH SIZE 4 thru 16
(1/4" - 1")
 METRIC SIZE 6 thru 25
(6-25mm)

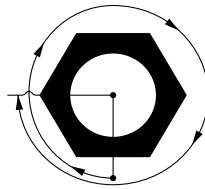

1-1/4 Turns from Finger Tight

1. Parker instrument tube fittings are sold completely assembled and ready for immediate use. Simply insert the tube as illustrated until it bottoms in the fitting body. (If the fitting is disassembled, note that the small tapered end of the ferrule(s) go into the fitting body.)
2. Tighten nut finger tight. Then tighten nut with wrench an additional 3/4 or 1-1/4 turns indicated at left. Hold fitting body with a second wrench to prevent body from turning. It is helpful to mark the nut to facilitate counting the number of turns.

For maximum number of remakes, mark the fitting and nut before disassembly. Before retightening, make sure the assembly has been inserted into the fitting until the ferrule seats in the fitting. Retighten the nut by hand. Rotate the nut with a wrench to the original position as indicated by the previous marks lining up. (A noticeable increase in mechanical resistance will be felt indicating the ferrule is being re-sprung into sealing position.)

Only after several remakes will it become necessary to advance the nut slightly past the original position. This advance (indicated by B) need only be 10° - 20° (less than 1/3 of a hex flat).

For Sizes above 16 (1"), the Parker IPD Hydraulic Presetting Tool or Rotary Wrench Tool should be used. Cat. 4290.

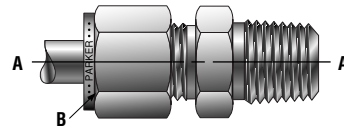

Parker CPI™/A-LOK® Tube Fitting part numbers use symbols to identify the size, style, and material. Tube and pipe thread sizes begin with a number indicating their size in sixteenths of an inch. For example, 4=4/16" or 1/4"; 16=16/16" or 1.

NOTE: Lubrication of the nut is REQUIRED for proper assembly on all LARGER size fittings in both inch and metric sizes. This requirement applies to:

- inch sizes of 20 and higher
- metric sizes of 25 and higher

Gaugeability Instructions*

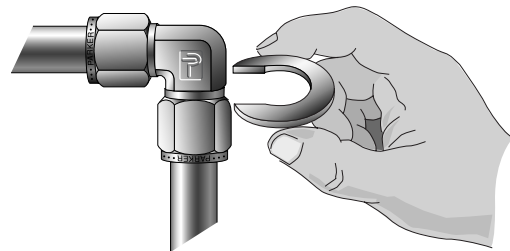
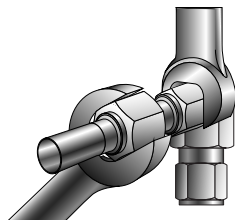

1. From "finger tight" position, wrench 1-1/4 turns for 1/4" to 1" size fittings (6mm to 25mm) (1/16", 1/8", 3/16", 2mm 3mm and 4mm size tube fittings only wrench 3/4 turn from finger tight position). Hold fitting body hex with second wrench to prevent body from turning as you tighten. It is a good idea to mark the nut (scribe or ink) to help you count the turns.

2. Now select the proper size inspection gauge and try to place it, as shown, between the nut and the body hex. If gauge DOES NOT FIT AT ANY POINT between them, you have correctly tightened the nut. If you can slip the gauge into the space, the fitting is not properly made up, and you must repeat the assembly procedure.

*For initial make up only.

Instrument Tubing Selection Guide

Parker's instrument tube fittings have been designed to work in a wide variety of applications that demand the utmost in product performance.

Although Parker's Instrument tube fittings have been engineered and manufactured to consistently provide this level of reliability, no systems integrity is complete without considering the critical link, tubing.

This booklet is intended to assist the designer to properly select and order quality tubing.

Proper tube selection and installation, we believe, are key ingredients in building leak-free reliable tubing systems.

General Selection Criteria

The most important consideration in the selection of suitable tubing for any application is the compatibility of the tubing material with the media to be contained. Table 1 lists common materials and their associated general application. Table 1 also lists the maximum and minimum operating temperature for the various tubing materials.

In addition, Parker instrument fittings are designed to work on like materials. Stainless steel fittings should be used only with stainless steel tubing, aluminum fittings with aluminum tubing, etc. The practice of mixing materials is strongly discouraged. The only exception is brass fittings with copper tubing.

Dissimilar materials in contact may be susceptible to galvanic corrosion. Further, different materials have different levels of hardness, and can adversely affect the fittings ability to seal on the tubing.

Table 1

TUBING MATERIAL	GENERAL APPLICATION	RECOMMENDED TEMPERATURE RANGE
Stainless Steel (Type 316)	High Pressure, High Temperature, Generally Corrosive Media	-425°F to 1,200°F ¹ (-255°C to 605°C)
Carbon Steel	High Pressure, High Temperature Oil, Air, Some Specialty Chemicals	-20°F to 800°F ² (-29°C to 425°C)
Copper	Low Temperature, Low Pressure Water, Oil, Air	-40°F to 400°F (-40°C to 205°C)
Aluminum	Low Temperature, Low Pressure Water, Oil, Air, Some Specialty Chemicals	-40°F to 400°F (-40°C to 205°C)
Monel® 400	Recommended for Sour Gas Applications Well Suited for Marine and General Chemical Processing Applications	-325°F to 800°F (-198°C to 425°C)
Hastelloy® C-276	Excellent Corrosion Resistance to Both Oxidizing and Reducing Media and Excellent Resistance to Localized Corrosion Attack	-325°F to 1000°F (-198°C to 535°C)
Carpenter® 20	Applications Requiring Resistance to Stress Corrosion Cracking in Extreme Conditions	-325°F to 800°F (-198°C to 425°C)
Inconel® Alloy 600	Recommended for High Temperature Applications with Generally Corrosive Media	-205°F to 1200°F (-130°C to 650°C)
Titanium	Resistant to Many Natural Environments such as Sea Water, Body Fluids and Salt Solutions	-75°F to 600°F (-59°C to 315°C)

1. For operating temperatures above 800°F (425°C), consideration should be given to media. 300 Series Stainless Steels are susceptible to carbide precipitation which may lead to intergranular corrosion at elevated temperatures.

2. Consideration should be given to maximum temperature ratings if fittings and/or tubing are coated or plated. All temperature ratings based on temperatures per ASME B31.3 Chemical Plant and Petroleum Refinery Piping Code, 1999 Edition.

The information listed in Table 1 is general in scope. For specific applications, please contact Parker's Instrumentation Products Division, Product Engineering Department (256) 881-2040.

NOTE: Hastelloy® is a registered trademark of Haynes International. Inconel®, and Monel® are registered trademarks of Special Metals Corporation. Carpenter® is a registered trademark of CRS Holdings Inc.

Gas Service

Special care must be taken when selecting tubing for gas service. In order to achieve a gas-tight seal, ferrules in instrument fittings must seal any surface imperfections. This is accomplished by the ferrules penetrating the surface of the tubing. Penetration can only be achieved if the tubing provides radial resistance and if the tubing material is softer than the ferrules.

Thick walled tubing helps to provide resistance. Tables 2–7 indicate the minimum acceptable wall thickness for various materials in gas service. The ratings in white indicate combination of diameter and wall thickness which are suitable for gas service.

Acceptable tubing hardness for general application is listed in Table 9. These values are the maximum allowed by ASTM. For gas service, better results can be obtained by using tubing well below this maximum hardness. For example, a desirable hardness of 80 Rb is suitable for stainless steel. The maximum allowed by ASTM is 90 Rb.

System Pressure

The system operating pressure is another important factor in determining the type, and more importantly, the size of tubing to be used. In general, high pressure installations require strong materials such as steel or stainless steel. Heavy walled softer tubing such as copper may be used if chemical compatibility exists with the media. However, the higher strength of steel or stainless steel permits the use of thinner tubes without reducing the ultimate rating of the system. In any event, tube fitting assemblies should never be pressurized beyond the recommended working pressure.

The following tables (2–7) list by material the maximum suggested working pressure of various tubing sizes. Acceptable tubing diameters and wall thicknesses are those for which a rating is listed. Combinations, which do not have a pressure rating, are not recommended for use with instrument fittings.

MAXIMUM ALLOWABLE WORKING PRESSURE TABLES

Table 2 316 or 304 STAINLESS STEEL (Seamless)																
Tube O.D. Size	Wall Thickness															
	0.010	0.012	0.014	0.016	0.020	0.028	0.035	0.049	0.065	0.083	0.095	0.109	0.120	0.134	0.156	0.188
1/16	5600	6900	8200	9500	12100	16800										
1/8						8600	10900									
3/16						5500	7000	10300								
1/4						4000	5100	7500	10300							
5/16							4100	5900	8100							
3/8							3300	4800	6600							
1/2							2600	3700	5100	6700						
5/8								3000	4000	5200	6100					
3/4								2400	3300	4300	5000	5800				
7/8								2100	2800	3600	4200	4900				
1									2400	3200	3700	4200	4700			
1-1/4										2500	2900	3300	3700	4100	4900	
1-1/2											2400	2700	3000	3400	4000	4500
2												2000	2200	2500	2900	3200

Table 3 316 or 304 STAINLESS STEEL (Welded)																
Tube O.D. Size	Wall Thickness															
	0.010	0.012	0.014	0.016	0.020	0.028	0.035	0.049	0.065	0.083	0.095	0.109	0.120	0.134	0.156	0.188
1/16	4800	5900	7000	8100	10300	14300										
1/8						7300	9300									
3/16						4700	6000	8700								
1/4						3400	4400	6400	8700							
5/16							3400	5000	6900							
3/8							2800	4100	5600							
1/2							2200	3200	4300	5700						
5/8								2500	3400	4500	5200					
3/4								2100	2800	3700	4200	4900				
7/8								1800	2400	3100	3600	4200				
1									2100	2700	3100	3600	4000			
1-1/4										2100	2400	2800	3100	3500	4200	
1-1/2											2000	2300	2600	2900	3400	4200
2												1700	1900	2100	2500	3000

Tube O.D. Size	Wall Thickness												
	0.028	0.035	0.049	0.065	0.083	0.095	0.109	0.120	0.134	0.148	0.165	0.180	
1/8	8100	10300											
3/16	5200	6700	9700										
1/4	3800	4900	7100	9700									
5/16		3800	5500	7700									
3/8		3100	4500	6200									
1/2		2300	3300	4500	6000								
5/8		1800	2600	3500	4600	5400							
3/4			2200	2900	3800	4400	5100						
7/8			1800	2500	3200	3700	4300						
1			1600	2100	2800	3200	3700	4100					
1-1/4				1700	2200	2500	2900	3200	3700	3800			
1-1/2					1800	2100	2400	2700	3000	3400	3800	4000	
2						1600	1800	2000	2200	2500	2800	3000	

Tube O.D. Size	Wall Thickness				
	0.035	0.049	0.065	0.083	0.095
1/8	8700				
3/16	5600	8100			
1/4	4100	5900			
5/16	3200	4600			
3/8	2600	3800			
1/2	1900	2800	3800		
5/8	1500	2200	2900		
3/4		1800	2400	3200	
7/8		1500	2100	2700	
1		1300	1800	2300	2700

Tube O.D. Size	Wall Thickness									
	0.010	0.020	0.028	0.035	0.049	0.065	0.083	0.095	0.109	0.120
1/16	1700	3800	5400							
1/8			2800	3600						
3/16			1800	2300	3500					
1/4			1300	1700	2600	3500				
5/16				1300	2000	2800				
3/8				1100	1600	2300				
1/2				800	1200	1600	2200			
5/8					900	1300	1700	2000		
3/4					800	1000	1400	1600	1900	
7/8					600	900	1100	1300	1600	
1					600	800	1000	1200	1400	1500
1-1/8					500	700	900	1000	1200	1300
1-1/4							800	900	1100	1200
1-1/2							650	750	850	950

Tube O.D. Size	Wall Thickness									
	0.010	0.020	0.028	0.035	0.049	0.065	0.083	0.095	0.109	0.120
1/16	5500	11800	16300							
1/8			8100	10400						
3/16			5100	6600	9600					
1/4			3800	4800	7000	9600				
5/16				3800	5500	7500				
3/8				3100	4500	6100				
1/2				2300	3300	4500	5900			
5/8					2700	3700	4900	5600		
3/4					2300	3100	4000	4600	5400	
1						2300	2900	3400	3900	4400

- NOTE:**
- All working pressures have been calculated using the maximum allowable stress levels in accordance with ASME B31.3, Chemical Plant and Petroleum Refinery Piping Code, 1999 Edition.
 - All calculations are based on maximum outside diameter and minimum wall thickness.
 - All working pressures are ambient (72°F or 22°C) temperature.

System Temperature

Operating temperature is another factor in determining the proper tubing material. Copper and aluminum tubing are suitable for low temperature media. Stainless steel and carbon steel tubing are suitable for higher temperature media. Special alloys such as Alloy 600 are recommended for extremely high temperatures (see Table 1). Table 8 lists derating factors which should be applied to the working pressures listed in Tables 2–7 for elevated temperature conditions. Simply locate the correct factor in Table 8 and multiply this by the appropriate value in Tables 2–7 for elevated temperature working pressure.

Temperature		Copper	Aluminum	316 SS	304 SS	Steel	Monel 400
°F	(°C)						
100	(38)	1.00	1.00	1.00	1.00	1.00	1.00
200	(93)	.80	1.00	1.00	1.00	.96	.88
300	(149)	.78	.81	1.00	1.00	.90	.82
400	(204)	.50	.40	.97	.94	.86	.79
500	(260)			.90	.88	.82	.79
600	(316)			.85	.82	.77	.79
700	(371)			.82	.80	.73	.79
800	(427)			.80	.76	.59	.76
900	(486)			.78	.73		.43
1000	(538)			.77	.69		
1100	(593)			.62	.49		
1200	(649)			.37	.30		

EXAMPLE: 1/2 inch x .49 wall seamless 316 stainless steel tubing has a working pressure of 3700 psi @ room temperature. If the system were to operate @ 800°F (425°C), a factor of 80% or (.80) would apply (see Table 8) and the “at temperature” system pressure would be 3700 PSI x .80 = 2960 PSI.

Tubing Ordering Suggestions

Tubing for use with Parker instrument fittings must be carefully ordered to insure adequate quality for good performance. Each purchase order must specify the material nominal outside diameter, and wall thickness. Ordering to ASTM specifications insures that the tubing will be dimensionally, physically, and chemically within strict limits. Also, more stringent requirements may be added by the user. All tubing should be ordered free of scratches and suitable for bending.

A purchase order meeting the above criteria would read as follows:

“1/2 x .049 316 stainless steel, seamless, or welded and redrawn per ASTM A-249. Fully annealed, 80 Rb or less.
 Must be suitable for bending; surface scratches, and imperfections (incomplete weld seams) are not permissible.”

Table 9 lists specific ordering information for each material.

Table 9				
Material	Type	ASTM Tubing Spec.	Condition	Max. Recommended Hardness
Stainless Steel	304, 316, 316L	ASTM-A-269, A-249, A-213, A632	Fully Annealed	90 Rb
Copper	K or L	ASTM-B75 B68, B88 (K or L)*	Soft Annealed Temper 0	60 Max. Rockwell 15T
Carbon Steel	1010	SAE-J524b, J525b ASTM-A-179	Fully Annealed	72 Rb
Aluminum	Alloy 6061	ASTM B-210	T6 Temper	56 Rb
Monel® 400	400	ASTM B-165	Fully Annealed	75 Rb
Hastelloy® C-276	C-276	ASTM-B-622, B-626	Fully Annealed	90 Rb
Inconel® Alloy 600	600	ASTM B-167	Fully Annealed	90 Rb
Carpenter® 20	20CB-3	ASTM B-468	Fully Annealed	90 Rb
Titanium	Commercially Pure Grade 2	ASTM B-338	Fully Annealed	99 Rb 200 Brinell Typical

*B88 Copper Tube to be ordered non-engraved

NOTE: Hastelloy® is a registered trademark of Haynes International. Inconel®, and Monel® are registered trademarks of Special Metals Corporation. Carpenter® is a registered trademark of CRS Holdings Inc.

Pipe Pressure Ratings

NPT / BSPT Pipe Size	BRASS			
	Male		Female	
	Straight ^a	Shape ^b	Straight ^a	Shape ^b
1/16	6000	5500	4500	3800
1/8	5600	5000	4000	2900
1/4	4100	4100	4300	3000
3/8	4000	4000	3500	2700
1/2	3900	3100	3600	2500
3/4	3800	3400	3000	2000
1	2700	2700	3100	2300
1-1/4	2000	2000	2300	1900
1-1/2	1800	1800	2100	1700
2	1600	1600	2000	1500

NPT / BSPT Pipe Size	STAINLESS STEEL			
	Male		Female	
	Straight ^a	Shape ^b	Straight ^a	Shape ^b
1/16	10000	9500	7500	7000
1/8	9100	9100	6400	5500
1/4	7500	7500	6600	5600
3/8	7200	7200	5300	5000
1/2	6600	5800	5200	4500
3/4	6400	6400	4300	3500
1	4600	4600	4500	3900
1-1/4	3500	3500	3500	3100
1-1/2	2900	2900	3200	2500
2	2600	2600	2700	2300

NPT / BSPT Pipe Size	CARBON STEEL			
	Male		Female	
	Straight ^a	Shape ^b	Straight ^a	Shape ^b
1/16	10500	10100	8000	7500
1/8	9700	9700	6800	5900
1/4	8000	8000	7000	6000
3/8	7600	7600	5600	5300
1/2	7000	6200	5500	4800
3/4	6800	6800	4600	3700
1	4900	4900	4800	4200
1-1/4	3700	3700	3700	3300
1-1/2	3100	3100	3400	2600
2	2800	2800	2800	2400

Notes:

- a. Fittings manufactured from bar stock.
- b. Fittings manufactured from forgings.
- c. Material of construction in accordance with [Table 1](#).
- d. Pressure ratings for fittings with both tube and pipe ends are rated to the lower pressure.



NPT Thread

Straight Thread

Tubing O.D. Size

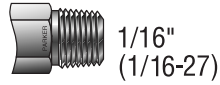

1/16"
(1/16-27)



5/16-24

○ 1/16"

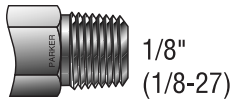

1/8"
(1/8-27)

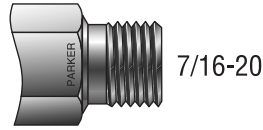

7/16-20

○ 1/8"

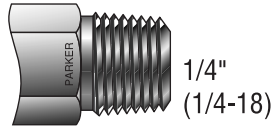

1/4"
(1/4-18)

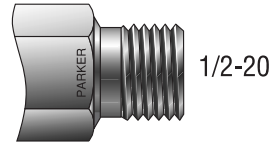

1/2-20

○ 3/16"

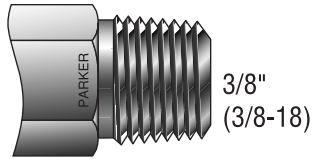

3/8"
(3/8-18)

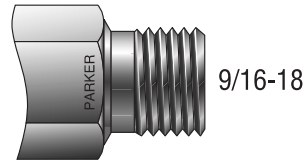

9/16-18

○ 1/4"

○ 5/16"

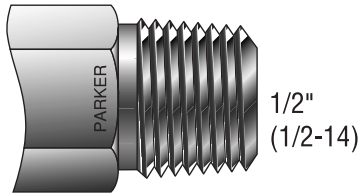

1/2"
(1/2-14)

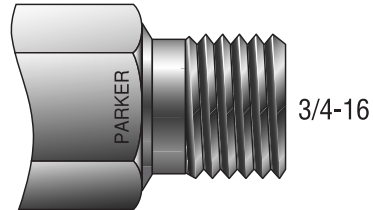

3/4-16

○ 3/8"

○ 1/2"

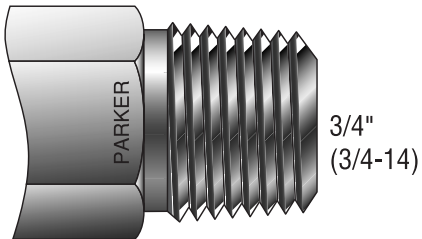

3/4"
(3/4-14)

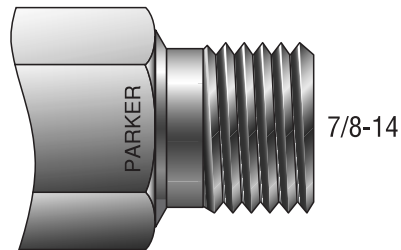

7/8-14

○ 5/8"

○ 3/4"

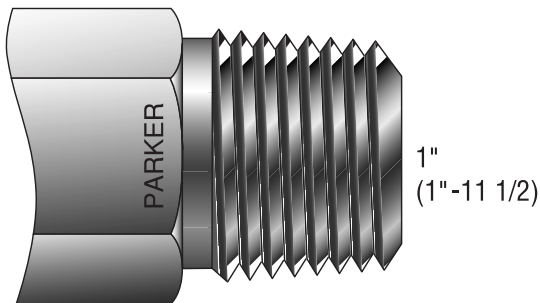

1"
(1-11 1/2)

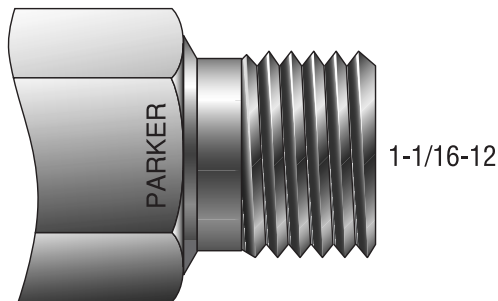

1-1/16-12

○ 7/8"

○ 1"

American Standard Pipe Thread (NPT)

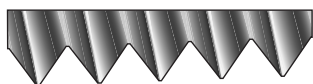

- 60° thread angle • Pitch measured in inches
- Truncation of root and crest are flat
- Taper angle 1°47'

American Standard Unified Thread (Straight)

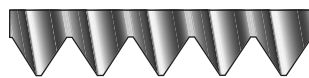

- 60° thread angle • Pitch measured in inches
- Truncation of root and crest are flat
- Diameter measured in inches

NPT Thread

Tubing O.D. Size

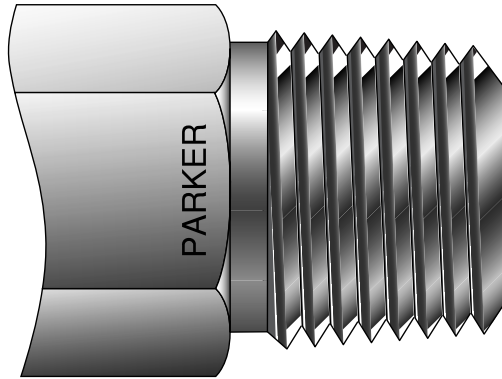

1-1/4"
(1-1/4" - 11-1/2")

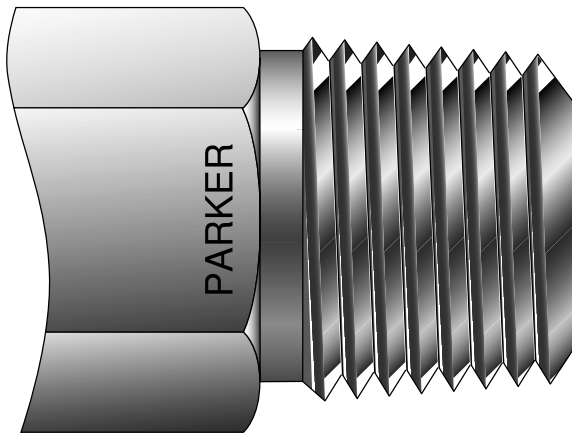
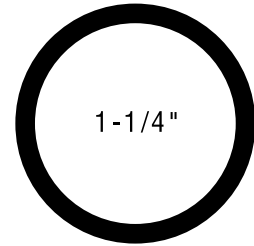



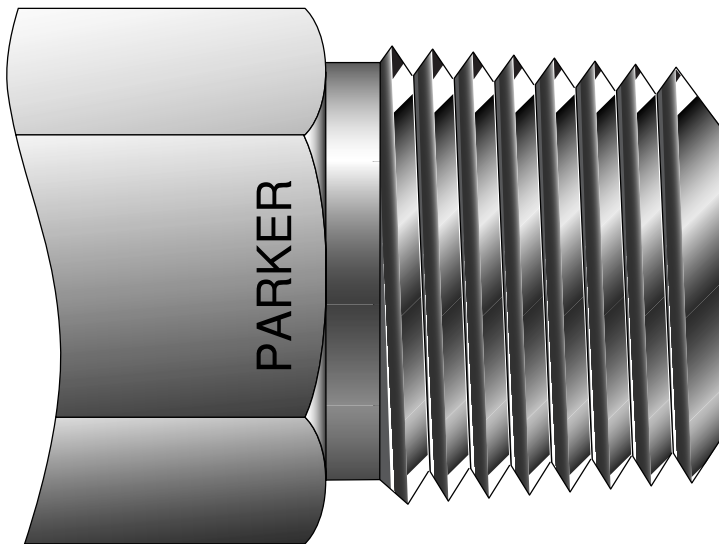
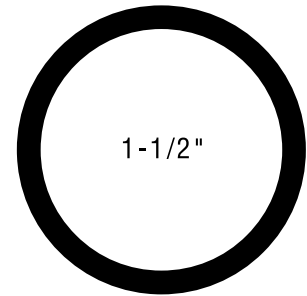



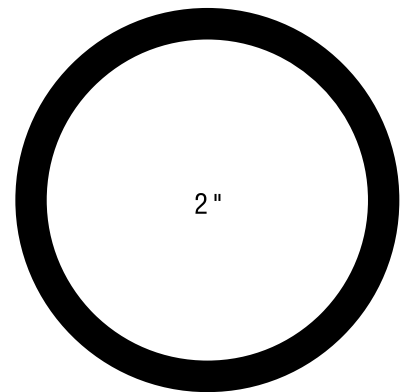

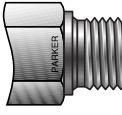





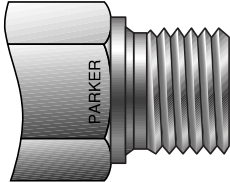

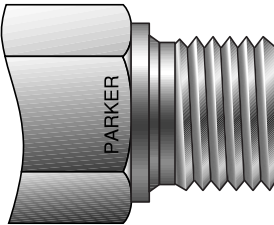

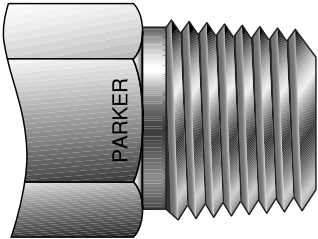
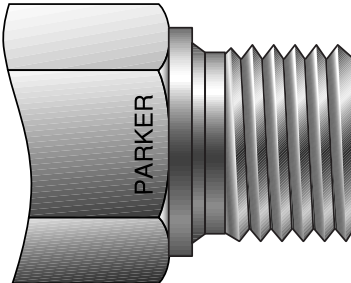

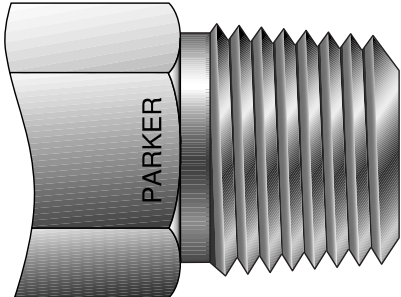
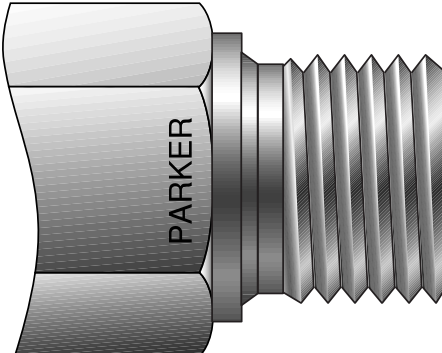

1-1/2"
(1-1/2" - 11-1/2")

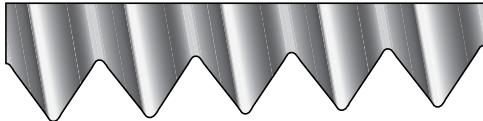
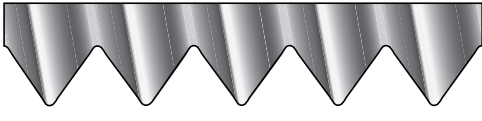

2"
(2" - 11-1/2")



BSPT Tapered Thread		BSPP Parallel Thread		Tubing O.D. Size	
	1/8" (1/8"-28)		1/8" (1/8"-28)		2mm
	1/4" (1/4"-19)		1/4" (1/4"-19)		3mm
	3/8" (3/8"-19)		3/8" (3/8"-19)		4mm
	1/2" (1/2"-14)		1/2" (1/2"-14)		6mm
	3/4" (3/4"-14)		3/4" (3/4"-14)		8mm
	1" (1"-11)		1" (1"-11)		10mm
International Organization for Standards					12mm
(ISO 7/1)		(ISO 228/1)			14mm
					15mm
55° thread angle • Pitch measured in inches • Truncation of root and crest are round • Taper angle 1°47'		55° thread angle • Pitch measured in inches • Truncation of root and crest are round • Diameter measured in inches			16mm
					18mm
					20mm
					22mm
					25mm

Offer of Sale

The items described in this document and other documents and descriptions provided by Parker Hannifin Corporation, its subsidiaries and its authorized distributors ("Seller") are hereby offered for sale at prices to be established by Seller. This offer and its acceptance by any customer ("Buyer") shall be governed by all of the following Terms and Conditions. Buyer's order for any item described in its document, when communicated to Seller verbally, or in writing, shall constitute acceptance of this offer. All goods or work described will be referred to as "Products".

1. Terms and Conditions. Seller's willingness to offer Products, or accept an order for Products, to or from Buyer is expressly conditioned on Buyer's assent to these Terms and Conditions and to the terms and conditions found on-line at www.parker.com/sale/terms/. Seller objects to any contrary or additional term or condition of Buyer's order or any other document issued by Buyer.

2. Price Adjustments; Payments. Prices stated on the reverse side or preceding pages of this document are valid for 30 days. After 30 days, Seller may change prices to reflect any increase in its costs resulting from state, federal or local legislation, price increases from its suppliers, or any change in the rate, charge, or classification of any carrier. The prices stated on the reverse or preceding pages of this document do not include any sales, use, or other taxes unless so stated specifically. Unless otherwise specified by Seller, all prices are F.O.B. Seller's facility, and payment is due 30 days from the date of invoice. After 30 days, Buyer shall pay interest on any unpaid invoices at the rate of 1.5% per month or the maximum allowable rate under applicable law.

3. Delivery Dates; Title and Risk; Shipment. All delivery dates are approximate and Seller shall not be responsible for any damages resulting from any delay. Regardless of the manner of shipment, title to any products and risk of loss or damage shall pass to Buyer upon tender to the carrier at Seller's facility (i.e., when it's on the truck, it's yours). Unless otherwise stated, Seller may exercise its judgment in choosing the carrier and means of delivery. No deferment of shipment at Buyer's request beyond the respective dates indicated will be made except on terms that will indemnify, defend and hold Seller harmless against all loss and additional expense. Buyer shall be responsible for any additional shipping charges incurred by Seller due to Buyer's changes in shipping, product specifications or in accordance with Section 13, herein.

4. Warranty. Seller warrants that the Products sold here-under shall be free from defects in material or workmanship for a period of twelve months from the date of delivery to Buyer or 2,000 hours of normal use, whichever occurs first. This warranty is made only to Buyer and does not extend to anyone to whom Products are sold after purchased from Seller. The prices charged for Seller's products are based upon the exclusive limited warranty stated above, and upon the following disclaimer: **DISCLAIMER OF WARRANTY: THIS WARRANTY COMPRISES THE SOLE AND ENTIRE WARRANTY PERTAINING TO PRODUCTS PROVIDED HEREUNDER. SELLER DISCLAIMS ALL OTHER WARRANTIES, EXPRESS AND IMPLIED, INCLUDING MERCHANTABILITY AND FITNESS FOR A PARTICULAR PURPOSE.**

5. Claims; Commencement of Actions. Buyer shall promptly inspect all Products upon delivery. No claims for shortages will be allowed unless reported to the Seller within 10 days of delivery. No other claims against Seller will be allowed unless asserted in writing within 60 days after delivery or, in the case of an alleged breach of warranty, within 30 days after the date within the warranty period on which the defect is or should have been discovered by Buyer. Any action based upon breach of this agreement or upon any other claim arising out of this sale (other than an action by Seller for any amount due to Seller from Buyer) must be commenced within thirteen months from the date of tender of delivery by Seller or, for a cause of action based upon an alleged breach of warranty, within thirteen months from the date within the warranty period on which the defect is or should have been discovered by Buyer.

6. LIMITATION OF LIABILITY. UPON NOTIFICATION, SELLER WILL, AT ITS OPTION, REPAIR OR REPLACE A DEFECTIVE PRODUCT, OR REFUND THE PURCHASE PRICE. IN NO EVENT SHALL SELLER BE LIABLE TO BUYER FOR ANY SPECIAL, INDIRECT, INCIDENTAL OR CONSEQUENTIAL DAMAGES ARISING OUT OF, OR AS THE RESULT OF, THE SALE, DELIVERY, NON-DELIVERY, SERVICING, USE OR LOSS OF USE OF THE PRODUCTS OR ANY PART THEREOF, OR FOR ANY CHARGES OR EXPENSES OF ANY NATURE INCURRED WITHOUT SELLER'S WRITTEN CONSENT, EVEN IF SELLER HAS BEEN NEGLIGENT, WHETHER IN CONTRACT, TORT OR OTHER LEGAL THEORY. IN NO EVENT SHALL SELLER'S LIABILITY UNDER ANY CLAIM MADE BY BUYER EXCEED THE PURCHASE PRICE OF THE PRODUCTS.

7. Contingencies. Seller shall not be liable for any default or delay in performance if caused by circumstances beyond the reasonable control of Seller.

8. User Responsibility. The user, through its own analysis and testing, is solely responsible for making the final selection of the system and Product and assuring that all performance, endurance, maintenance, safety and warning requirements of the application are met. The user must analyze all aspects of the application and follow applicable industry standards and Product information. If Seller provides Product or system options, the user is responsible for determining that such data and specifications are suitable and sufficient for all applications and reasonably foreseeable uses of the Products or systems.

9. Loss to Buyer's Property. Any designs, tools, patterns, materials, drawings, confidential information or equipment furnished by Buyer or any other items which become Buyer's property, may be considered obsolete and may be destroyed by Seller after two consecutive years have elapsed without Buyer placing an order for the items which are manufactured using such property. Seller shall not be responsible for any loss or damage to such property while it is in Seller's possession or control.

10. Special Tooling. A tooling charge may be imposed for any special tooling, including without limitation, dies, fixtures, molds and patterns, acquired to manufacture Products. Such special tooling shall be and remain Seller's property notwithstanding payment of any charges by Buyer. In no event will Buyer acquire any interest in apparatus belonging to Seller which is utilized in the manufacture of the Products, even if such apparatus has been specially converted or adapted for such manufacture and notwithstanding any charges paid by Buyer. Unless otherwise agreed, Seller shall have the right to alter, discard or otherwise dispose of any special tooling or other property in its sole discretion at any time.

11. Buyer's Obligation; Rights of Seller. To secure payment of all sums due or otherwise, Seller shall retain a security interest in the goods delivered and this agreement shall be deemed a Security Agreement under the Uniform Commercial Code. Buyer authorizes Seller as its attorney to execute and file on Buyer's behalf all documents Seller deems necessary to perfect its security interest. Seller shall have a security interest in, and lien upon, any property of Buyer in Seller's possession as security for the payment of any amounts owed to Seller by Buyer.

12. Improper use and Indemnity. Buyer shall indemnify, defend, and hold Seller harmless from any claim, liability, damages, lawsuits, and costs (including attorney fees), whether for personal injury, property damage, patent, trademark or copyright infringement or any other claim, brought by or incurred by Buyer, Buyer's employees, or any other person, arising out of: (a) improper selection, improper application or other misuse of Products purchased by Buyer from Seller; (b) any act or omission, negligent or otherwise, of Buyer; (c) Seller's use of patterns, plans, drawings, or specifications furnished by Buyer to manufacture Product; or (d) Buyer's failure to comply with these terms and conditions. Seller shall not indemnify Buyer under any circumstance except as otherwise provided.

13. Cancellations and Changes. Orders shall not be subject to cancellation or change by Buyer for any reason, except with Seller's written consent and upon terms that will indemnify, defend and hold Seller harmless against all direct, incidental and consequential loss or damage. Seller may change product features, specifications, designs and availability with notice to Buyer.

14. Limitation on Assignment. Buyer may not assign its rights or obligations under this agreement without the prior written consent of Seller.

15. Entire Agreement. This agreement contains the entire agreement between the Buyer and Seller and constitutes the final, complete and exclusive expression of the terms of the agreement. All prior or contemporaneous written or oral agreements or negotiations with respect to the subject matter are herein merged.

16. Waiver and Severability. Failure to enforce any provision of this agreement will not waive that provision nor will any such failure prejudice Seller's right to enforce that provision in the future. Invalidation of any provision of this agreement by legislation or other rule of law shall not invalidate any other provision herein. The remaining provisions of this agreement will remain in full force and effect.

17. Termination. This agreement may be terminated by Seller for any reason and at any time by giving Buyer thirty (30) days written notice of termination. In addition, Seller may by written notice immediately terminate this agreement for the following: (a) Buyer commits a breach of any provision of this agreement (b) the appointment of a trustee, receiver or custodian for all or any part of Buyer's property (c) the filing of a petition for relief in bankruptcy of the other Party on its own behalf, or by a third party (d) an assignment for the benefit of creditors, or (e) the dissolution or liquidation of the Buyer.

18. Governing Law. This agreement and the sale and delivery of all Products hereunder shall be deemed to have taken place in and shall be governed and construed in accordance with the laws of the State of Ohio, as applicable to contracts executed and wholly performed therein and without regard to conflicts of laws principles. Buyer irrevocably agrees and consents to the exclusive jurisdiction and venue of the courts of Cuyahoga County, Ohio with respect to any dispute, controversy or claim arising out of or relating to this agreement. Disputes between the parties shall not be settled by arbitration unless, after a dispute has arisen, both parties expressly agree in writing to arbitrate the dispute.

19. Indemnity for Infringement of Intellectual Property Rights. Seller shall have no liability for infringement of any patents, trademarks, copyrights, trade dress, trade secrets or similar rights except as provided in this Section. Seller will defend and indemnify Buyer against allegations of infringement of U.S. patents, U.S. trademarks, copyrights, trade dress and trade secrets ("Intellectual Property Rights"). Seller will defend at its expense and will pay the cost of any settlement or damages awarded in an action brought against Buyer based on an allegation that a Product sold pursuant to this Agreement infringes the Intellectual Property Rights of a third party. Seller's obligation to defend and indemnify Buyer is contingent on Buyer notifying Seller within ten (10) days after Buyer becomes aware of such allegations of infringement, and Seller having sole control over the defense of any allegations or actions including all negotiations for settlement or compromise. If a Product is subject to a claim that it infringes the Intellectual Property Rights of a third party, Seller may, at its sole expense and option, procure for Buyer the right to continue using the Product, replace or modify the Product so as to make it noninfringing, or offer to accept return of the Product and return the purchase price less a reasonable allowance for depreciation. Notwithstanding the foregoing, Seller shall have no liability for claims of infringement based on information provided by Buyer, or directed to Products delivered hereunder for which the designs are specified in whole or part by Buyer, or infringements resulting from the modification, combination or use in a system of any Product sold hereunder. The foregoing provisions of this Section shall constitute Seller's sole and exclusive liability and Buyer's sole and exclusive remedy for infringement of Intellectual Property Rights.

20. Taxes. Unless otherwise indicated, all prices and charges are exclusive of excise, sales, use, property, occupational or like taxes which may be imposed by any taxing authority upon the manufacture, sale or delivery of Products.

21. Equal Opportunity Clause. For the performance of government contracts and where dollar value of the Products exceed \$10,000, the equal employment opportunity clauses in Executive Order 11246, VEVRAA, and 41 C.F.R. §§ 60-1.4(a), 60-741.5(a), and 60-250.4, are hereby incorporated.

01/09



Parker's Motion & Control Technologies

At Parker, we're guided by a relentless drive to help our customers become more productive and achieve higher levels of profitability by engineering the best systems for their requirements. It means looking at customer applications from many angles to find new ways to create value. Whatever the motion and control technology need, Parker has the experience, breadth of product and global reach to consistently deliver. No company knows more about motion and control technology than Parker. For further info call 1-800-C-Parker.



AEROSPACE

Key Markets

- Aircraft engines
- Business & general aviation
- Commercial transports
- Land-based weapons systems
- Military aircraft
- Missiles & launch vehicles
- Regional transports
- Unmanned aerial vehicles

Key Products

- Flight control systems & components
- Fluid conveyance systems
- Fluid metering delivery & atomization devices
- Fuel systems & components
- Hydraulic systems & components
- Inert nitrogen generating systems
- Pneumatic systems & components
- Wheels & brakes



CLIMATE CONTROL

Key Markets

- Agriculture
- Air conditioning
- Food, beverage & dairy
- Life sciences & medical
- Precision cooling
- Processing
- Transportation

Key Products

- CO₂ controls
- Electronic controllers
- Filter driers
- Hand shut-off valves
- Hose & fittings
- Pressure regulating valves
- Refrigerant distributors
- Safety relief valves
- Solenoid valves
- Thermostatic expansion valves

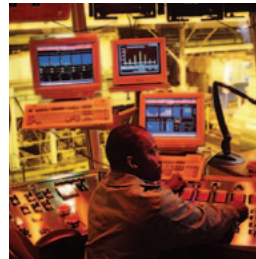

ELECTROMECHANICAL

Key Markets

- Aerospace
- Factory automation
- Life science & medical
- Machine tools
- Packaging machinery
- Paper machinery
- Plastics machinery & converting
- Primary metals
- Semiconductor & electronics
- Textile
- Wire & cable

Key Products

- AC/DC drives & systems
- Electric actuators, gantry robots & slides
- Electrohydraulic actuation systems
- Electromechanical actuation systems
- Human machine interface
- Linear motors
- Stepper motors, servo motors, drives & controls
- Structural extrusions



FILTRATION

Key Markets

- Food & beverage
- Industrial machinery
- Life sciences
- Marine
- Mobile equipment
- Oil & gas
- Power generation
- Process
- Transportation

Key Products

- Analytical gas generators
- Compressed air & gas filters
- Condition monitoring
- Engine air, fuel & oil filtration & systems
- Hydraulic, lubrication & coolant filters
- Process, chemical, water & microfiltration filters
- Nitrogen, hydrogen & zero air generators



FLUID & GAS HANDLING

Key Markets

- Aerospace
- Agriculture
- Bulk chemical handling
- Construction machinery
- Food & beverage
- Fuel & gas delivery
- Industrial machinery
- Mobile
- Oil & gas
- Transportation
- Welding

Key Products

- Brass fittings & valves
- Diagnostic equipment
- Fluid conveyance systems
- Industrial hose
- PTFE & PFA hose, tubing & plastic fittings
- Rubber & thermoplastic hose & couplings
- Tube fittings & adapters
- Quick disconnects



HYDRAULICS

Key Markets

- Aerospace
- Aerial lift
- Agriculture
- Construction machinery
- Forestry
- Industrial machinery
- Mining
- Oil & gas
- Power generation & energy
- Truck hydraulics

Key Products

- Diagnostic equipment
- Hydraulic cylinders & accumulators
- Hydraulic motors & pumps
- Hydraulic systems
- Hydraulic valves & controls
- Power take-offs
- Rubber & thermoplastic hose & couplings
- Tube fittings & adapters
- Quick disconnects

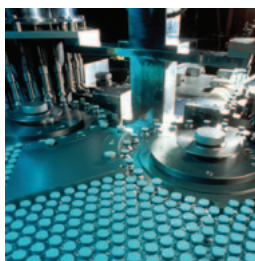

PNEUMATICS

Key Markets

- Aerospace
- Conveyor & material handling
- Factory automation
- Life science & medical
- Machine tools
- Packaging machinery
- Transportation & automotive

Key Products

- Air preparation
- Brass fittings & valves
- Manifolds
- Pneumatic accessories
- Pneumatic actuators & grippers
- Pneumatic valves & controls
- Quick disconnects
- Rotary actuators
- Rubber & thermoplastic hose & couplings
- Structural extrusions
- Thermoplastic tubing & fittings
- Vacuum generators, cups & sensors



PROCESS CONTROL

Key Markets

- Chemical & refining
- Food, beverage & dairy
- Medical & dental
- Microelectronics
- Oil & gas
- Power generation

Key Products

- Analytical sample conditioning products & systems
- Fluoropolymer chemical delivery fittings, valves & pumps
- High purity gas delivery fittings, valves & regulators
- Instrumentation fittings, valves & regulators
- Medium pressure fittings & valves
- Process control manifolds



SEALING & SHIELDING

Key Markets

- Aerospace
- Chemical processing
- Consumer
- Energy, oil & gas
- Fluid power
- General industrial
- Information technology
- Life sciences
- Military
- Semiconductor
- Telecommunications
- Transportation

Key Products

- Dynamic seals
- Elastomeric o-rings
- EMI shielding
- Extruded & precision-cut, fabricated elastomeric seals
- Homogeneous & inserted elastomeric shapes
- High temperature metal seals
- Metal & plastic retained composite seals
- Thermal management



Sales Offices Worldwide

Parker Hannifin Corporation

Instrumentation Products Division
1005 A Cleaner Way
Huntsville, AL 35805
USA
phone 256 881 2040
fax 256 8815072
www.parker.com/ipdus

Parker Hannifin Corporation

Instrumentation Products Division
2651 Alabama Highway 21 North
Jacksonville, AL 36265-681
USA
phone 256 435 2130
fax 256 435 7718
www.parker.com/ipdus

Parker Hannifin Corporation

Instrumentation Products Division
6575 Tram Road
Beaumont, TX 77713
USA
phone 409 924 0300
fax 409 924 0301
www.parker.com/ipdus

Parker Hannifin plc

Instrumentation Products Division
Riverside Road
Pottington Business Park
Barnstaple, Devon EX31 1NP
England
phone +44 0 1271 313131
fax +44 0 1271 373636
email ipd@parker.com
www.parker.com/ipd

Catalog 4230/4233 Dec2012 DP



Parker Hannifin Corporation
Instrumentation Products Division
1005 A Cleaner Way
Huntsville, AL 35805
phone 256 881 2040
fax 256 881 5072
www.parker.com/ipdus

Your Local Authorized Parker Distributor