

TL μ SERIES INSTRUCTION MANUAL

CONTROLS

OUTPUT LED

The red LED indicates the output status.

READY LED

During functioning, the green LED permanently ON indicates a normal operating condition; fast blinking indicates an output overload condition. See the "SETTING" paragraph for setup procedure indications.

MARK / BKGD PUSHBUTTON

The pushbutton activates the setup procedure.

INSTALLATION

Operating distance is rated starting from the lens front face. The M12 connector or cable exit can be rotated in three positions by loosening the locking screw. Tighten the locking screw when finished.

The beam direction may be changed swapping the cap and the lens.

Detecting marks on a reflective surface is improved adjusting the beam direction to 5° ... 20° from surface axis.

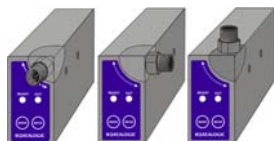

CONNECTIONS

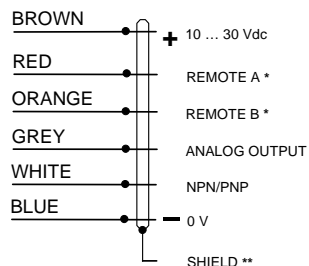

* = Connect the unused REMOTE wires to 0 V.

** = The cable shield is insulated from the sensor housing; it is recommended to connect the shield to 0 V.

M12 CONNECTOR

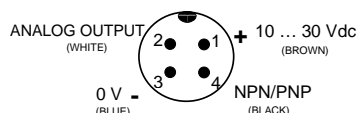

DIMENSIONS

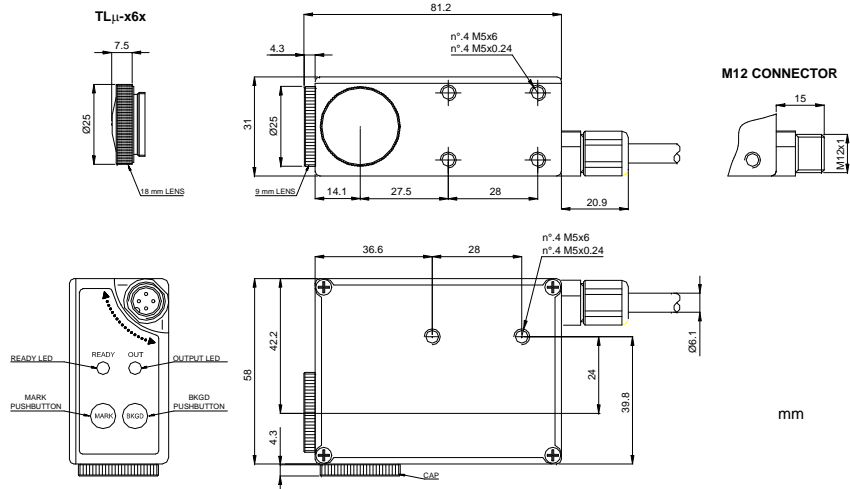

TECHNICAL DATA

Power supply:	10 ... 30 Vdc limit values; reverse polarity protection
Ripple:	2 Vpp max.
Current consumption (output current excluded):	80 mA max.
Output:	NPN or PNP, pull down/up resistance 10 k Ω (short-circuit protection)
Output current:	200 mA max.
Analog output:	0 ... 2 V \pm 10% (white 90%); 5.5 V max.; ripple 40 mVpp max.; output resistance 2.2 k Ω
Output saturation voltage:	1V max. NPN versions / 2V max PNP versions
Response time:	50 μ s max. / 25 μ s max. (TL μ -4xx/5xx)
Switching frequency:	10 kHz max. / 20 kHz max. (TL μ -4xx/5xx)
Timing function:	20 ms minimum output ON
Indicators:	OUTPUT LED (RED) / READY LED (GREEN)
Setting:	by pushbuttons / by wires; 4 settings storage cable version
Retention data:	non volatile EEPROM memory
Operating temperature:	-10 ... 55 °C
Storage temperature:	-20 ... 70 °C
Electric shock protection:	Class 1
Operating distance:	9 mm (TL μ -x1x/4xx/5xx) / 18 mm (TL μ -x6x)
Minimum spot dimension:	1.5 x 5 mm (TL μ -x1x) / 2 x 7 mm (TL μ -x6x) / \varnothing 3 mm (TL μ -4xx/5xx)
Depth of field:	\pm 3 mm (TL μ -x1x/4xx/5xx) / \pm 4 mm (TL μ -x6x)
Emission type:	green (526 nm) / red (630 nm) with automatic selection or white (400-700 nm)
Ambient light rejection:	according to EN 60947-5-2
Vibration:	0.5 mm amplitude, 10 ... 55 Hz frequency, in every axis (EN60068-2-6)
Shock resistance:	11 ms (30 G) 6 shock in every axis (EN60068-2-27)
DARK/LIGHT selection:	teach-in procedure
Housing:	ZAMA
Protection class:	IP67
Connections:	3 m shielded cable \varnothing 6.1 mm / M12 4-pole connector
Weight:	450 g. max. cable versions / 310 g. max. connector versions

CONFIGURATION

A double selector and a switch are available removing the sensor side cover. The selector allows to enable the output timing function and choose the pushbuttons and REMOTE inputs operating mode; the switch allows to select the output type (NPN or PNP).

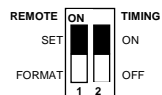

DETECTION DIAGRAM

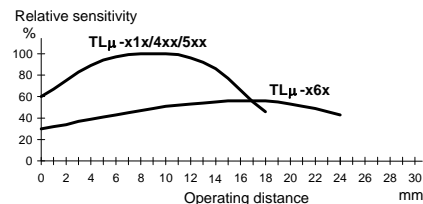

FUNCTION SELECTION

When **FORMAT** is selected (configuration selector section 1), the MARK and BKGD

N°: FORMAT	1	2	3	4
input REMOTE A	0V	0V	+V	+V
input REMOTE B	0V	+V	0V	+V

pushbuttons are enabled and connecting the REMOTE inputs (TL μ -xx1) to the power supply as shown in the table allows to select up to 4 different settings (formats). This is the factory setting.

If a non-set format is selected, the sensor is disabled and the green LED flashes at a low rate.

A setting can be stored selecting a format and executing the procedure described in the "SETTING" paragraph.

When **SET** is selected (configuration selector section 1), the MARK and BKGD pushbuttons are disabled; the REMOTE inputs (TL μ -x1x) replace the pushbuttons functionality.

Connecting the REMOTE A and B inputs to the positive power supply rail is equivalent to pressing the MARK and BKGD pushbuttons respectively. Connect the unused inputs to 0V.

TIMING FUNCTION

When **ON** is selected (configuration selector section 2), a delay timer function is enabled which extends the minimum ON

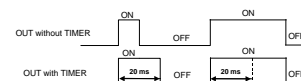

output time to 20 ms. The factory setting is OFF (timer disabled).

SETTING

A two-step setup procedure adjusts the switching threshold and the LIGHT/DARK mode. Using the procedure given below the sensor output is set to be ON when a mark is detected.

1) Output ON state acquisition (MARK)
Place the target mark into the emission spot and press the MARK pushbutton until the green LED turns OFF. Don't move the mark during the setting phase (about 1 sec).

2) Output OFF state acquisition (BKGD)
Place the background into the emission spot and press the BKGD pushbutton; the green LED blinks once. Don't move the background during the setting phase.

If the green LED lights permanently ON, a safe operation has been obtained; if it flashes at a low rate the setup procedure has failed due to insufficient contrast; repeat the procedure from the beginning.

DECLARATION OF CONFORMITY

We DATALOGIC AUTOMATION declare under our sole responsibility that these products are conform to the 2004/108/CE and successive amendments.



WARRANTY

DATALOGIC AUTOMATION warrants its products to be free from defects.

DATALOGIC AUTOMATION will repair or replace, free of charge, any product found to be defective during the warranty period of 36 months from the manufacturing date.

This warranty does not cover damage or liability deriving from the improper application of DATALOGIC AUTOMATION products.

DATALOGIC AUTOMATION cares for the environment: 100% recycled paper. DATALOGIC AUTOMATION reserves the right to make modifications and improvements without prior notification.

Datalogic and the Datalogic logo are registered trademarks of Datalogic S.p.A. in many countries, including the U.S.A. and the E.U.

82600025 Rev.G © Copyright Datalogic 2007-2009