



Original operating instructions
Fail-safe inductive sensor

GM505S

UK

80236825 / 00 09 / 2016

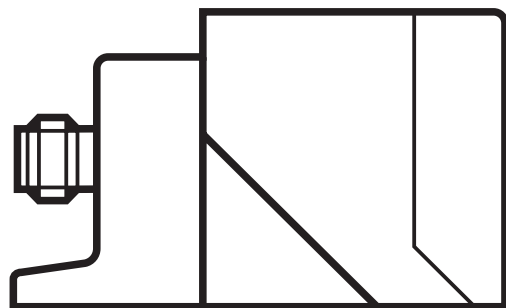

Contents

1	Preliminary note.....	3
1.1	Symbols used	3
1.2	Warning signs used	3
2	Safety instructions	4
2.1	Safety-related requirements regarding the application.....	4
3	Items supplied.....	5
4	Functions and features	5
5	Function	6
5.1	Enable zone.....	6
5.2	Protection against simple defeating.....	7
6	Installation.....	8
6.1	Alignment of the sensing face.....	8
6.2	Installation conditions	8
7	Electrical connection.....	10
7.1	Series connection of 2-10 fail-safe inductive sensors	10
8	Set-up	11
8.1	Setting aid.....	11
8.2	Determine the enable zone	11
8.3	Deactivate setting aid	12
9	Operation	12
9.1	Sensor signals	12
9.2	Input characteristics / output characteristics.....	13
9.3	Cross faults	13
9.4	Operating mode.....	14
9.4.1	Delayed switching of the LED.....	14
9.4.2	Switching of the LED without delay	15
9.5	Response times	15
9.6	LED display	16
10	Technical data	17
11	Troubleshooting	19

12 Maintenance, repair and disposal.....	19
13 Terms and abbreviations.....	19

1 Preliminary note

The instructions are part of the unit. They are intended for authorised persons according to the EMC, Low Voltage and Machinery Directives and safety regulations.

The instructions contain information about the correct handling of the product. Read the instructions before use to familiarise yourself with operating conditions, installation and operation.

Follow the safety instructions.

UK

1.1 Symbols used

▶ Instructions

→ Cross-reference



Important note

Non-compliance can result in malfunction or interference.



Information

Supplementary note.

● LED on

○ LED off

⊗ LED flashes (2 Hz)

⊛ LED flashes quickly (5 Hz)

1.2 Warning signs used

WARNING

Warning of serious personal injury.

Death or serious irreversible injuries may result.

2 Safety instructions

- Follow the operating instructions.
- Improper use may result in malfunctions of the unit. This can lead to personal injury and/or damage to property during operation of the machine. For this reason note all remarks on installation and handling given in this document. Also adhere to the safety instructions for the operation of the whole installation.
- In case of non-observance of notes or standards, especially when tampering with and/or modifying the unit, any liability and warranty is excluded.
- If the sensor is damaged, the safety function cannot be guaranteed.
- Errors caused by damage cannot be detected by the sensor.
- The unit must be installed, connected and put into operation by a qualified electrician trained in safety technology.
- The applicable technical standards for the corresponding application must be complied with.
- For installation the requirements according to EN 60204 must be observed.
- In case of malfunction of the unit please contact the manufacturer. Tampering with the unit is not allowed.
- Disconnect the unit externally before handling it. Also disconnect any independently supplied relay load circuits.
- After installation, maintenance or repair of the system perform a complete function check.
- Use the unit only in specified environmental conditions (→ 10 Technical data). In case of special operating conditions please contact the manufacturer.
- Use only as described below (→ 4).

2.1 Safety-related requirements regarding the application

It must be ensured that the safety requirements of the respective application correspond to the requirements stated in these instructions.

! WARNING

Failure of the safety function

When used outside of the defined environmental conditions, the safety-related function of the sensor cannot be guaranteed.

- ▶ Use only in accordance with the defined environmental conditions (→ 10 Technical data).

Use of the sensor in the vicinity of chemical and biological media (solid, liquid, gaseous) as well as ionising radiation is not permitted.

Observe the following requirements:

- ▶ Take measures to avoid metallic objects being placed on the sensing face unintentionally.
- ▶ Adhere to EN 14119 for interlocking devices associated with guards.
- ▶ Adhere to the principle of normally closed operation for all external safety circuits connected to the system.
- ▶ In case of faults within the fail-safe sensor which result in the defined safe state: take measures to maintain the safe state when the complete control system continues to be operated.
- ▶ Replace damaged units.

3 Items supplied

1 fail-safe sensor GM505S with premounted angle bracket,
1 Allen key for fixing the fail-safe sensor onto the angle bracket,
1 original operating instructions GM505S, ident no. 80236825.

If one of the above-mentioned components is missing or damaged, please contact one of the ifm branch offices.

4 Functions and features

The fail-safe inductive sensor GM505S detects metal without contact.

Safety function SF: the safe state (output stage switched off; logic "0") is achieved when undamping greater than or equal to the safe switch-off distance s_{ar} . (→ 10 Technical data).

Also observe the notes on installation of the sensor (→ 6 Installation).

The fail-safe inductive sensor is a proximity device with defined behaviour under fault conditions (PDDb) to IEC 60947-5-3.

The fail-safe sensor conforms to Performance Level e according to EN ISO 13849-1 as well as to the requirements SIL 3 to IEC 61508.

The unit corresponds to the classification I2C40SP2 to IEC 60947-5-2 for non-flush installation (→ 6 Installation).

The fail-safe inductive sensor has been certified by TÜV Nord.

5 Function

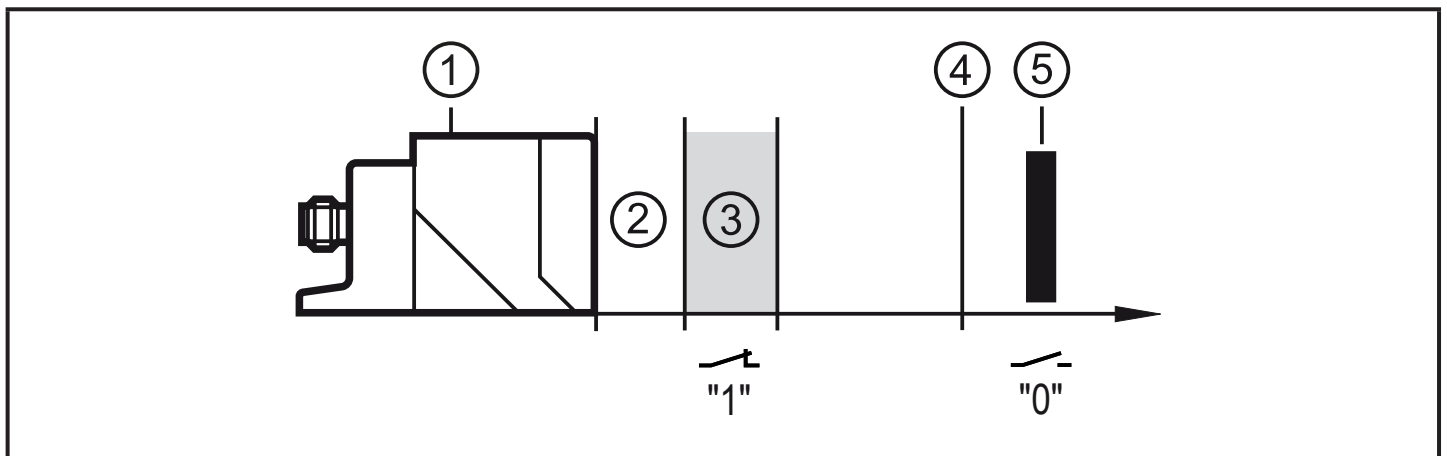

- 1: dual LED: signal (yellow); power (green)
- 2: close zone
- 3: enable zone
- 4: safe switch-off distance s_{ar}
- 5: target

5.1 Enable zone

The output is only enabled when damped in the enable zone. Outside this enable zone the output remains switched off.

The safe switch-off distance s_{ar} is > 35 mm.



The enable zone is different if damping elements which deviate from the standard target plate in terms of material, form and size are used.

Enable zone for selected materials*:

Material	Enable zone
FE360 (= mild steel)	10...20 mm
Stainless steel	7.5...15 mm
AlMg3G22	2.7...8.5 mm

Material	Enable zone
Al 99 %	1.9...7.9 mm
CuZn37	2.9...8.5 mm
Copper	1.3...7.0 mm

* Typical values for damping with a reference target of 60 x 60 x 1 mm and non-flush installation to IEC 60947-5-2 at an ambient temperature of 20 °C.



Depending on the characteristics of the damping element there may be no close zone.

5.2 Protection against simple defeating

UK

The fail-safe sensor reacts to metal objects, e.g. the frame of a safety door. Other metal objects that are not intended to enable the sensor must not be allowed to enable the fail-safe sensor unintentionally.



▶ Take measures to prevent metal objects, except the designated target, from being placed on the sensing face or in the enable zone unintentionally.

In addition, the sensor has the following switching characteristics to make simple defeating of its safety function more difficult:

1. By slowly introducing a metallic object into the enable zone, the output is immediately switched, but displayed by the signal LED with a delay of about 3 s (→ 9.4.1 Delayed switching of the LED). By doing so, the object is generally in the close range before the LED indication is lit. The technical instructions concerning the restart of the installation must be observed.
2. If the object stays in the close range for longer than approx. 2 s, the output is completely disabled and no longer enabled if damped in the enable zone. If the object stays in the close range for longer than approx. 5 s, the setting aid is activated (→ 8.1).

Release of the enable zone can be carried out

- either by undamping (> 35 mm) for a time of more than 2 s
 - or by a voltage interruption
- (→ 8.3 Deactivate setting aid).

6 Installation

6.1 Alignment of the sensing face

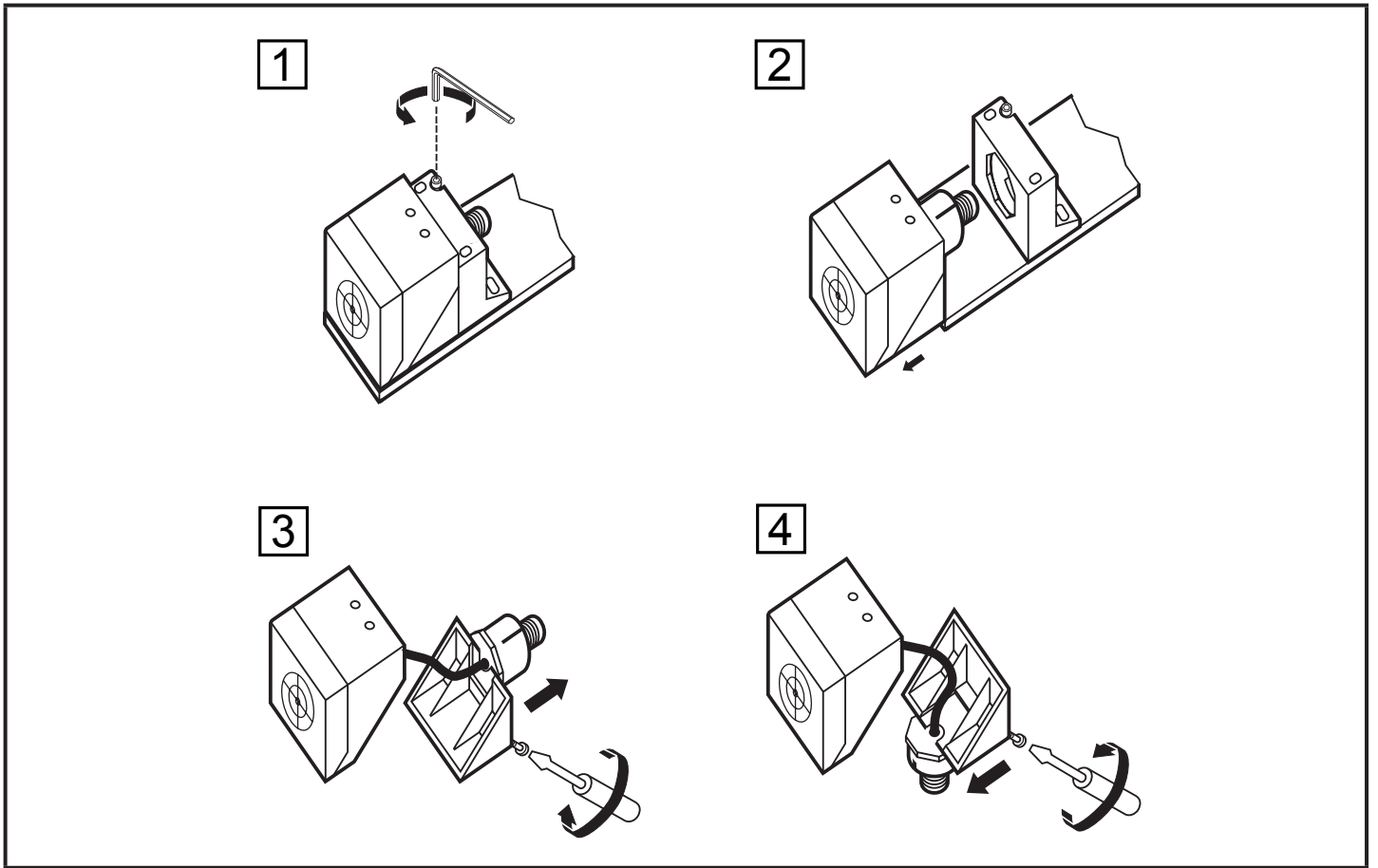

The socket is rotatable:

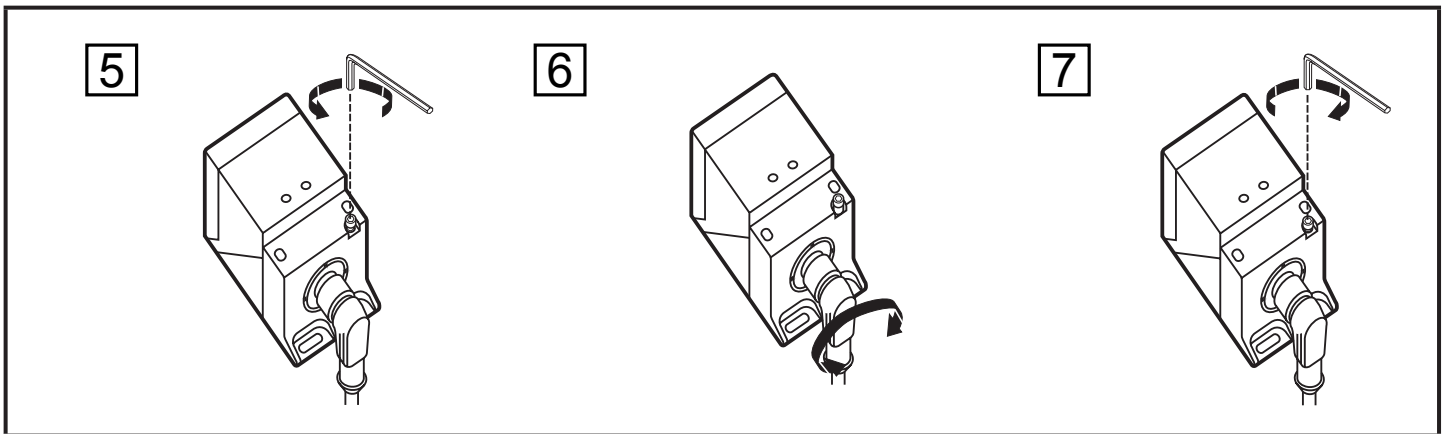

- Tighten the socket according to the manufacturer's indications. Observe the tightening torque for the ifm socket (e.g. EVxxxx: 0.6...1.5 Nm).

6.2 Installation conditions

The unit is **non-flush** mountable according to IEC 60947-5-2, type I2C40SP2.



Flush installation of the fail-safe sensor is not permitted since this can result in an increase of the sensing range up to enabling of the output.

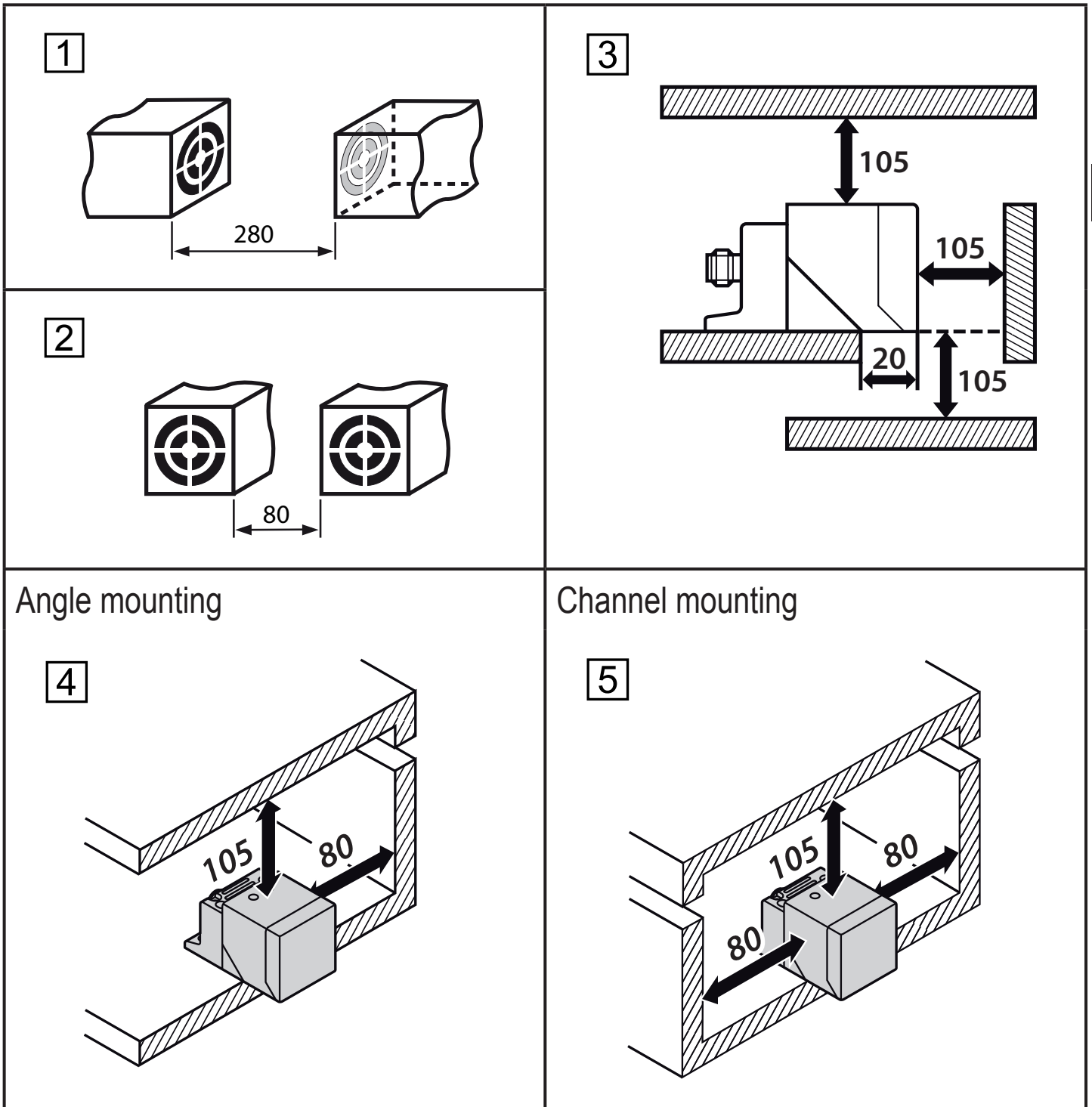

- ▶ Ensure the unit cannot work loose.
- ▶ Tighten captive screws with 1 Nm.
- ▶ Limit the use of oblong holes to the initial setting.
- ▶ Adhere to the installation conditions in accordance with the figures 1 to 5:



UK

7 Electrical connection

Wiring diagram → 10 Technical data

- ▶ Disconnect the unit. Also disconnect any independently supplied relay load circuits.
- ▶ Supply voltage: connect L+ to pin 1 and L- to pin 3 of the connector.
-  The nominal voltage is 24 V DC. This voltage may vary between 19.2 V and 30 V incl. 5 % residual ripple to EN 61131-2.
-  A safe industrial power supply with overvoltage protection must be used. In case of a fault, 42 V AC / 60 V DC must not be exceeded.

7.1 Series connection of 2-10 fail-safe inductive sensors

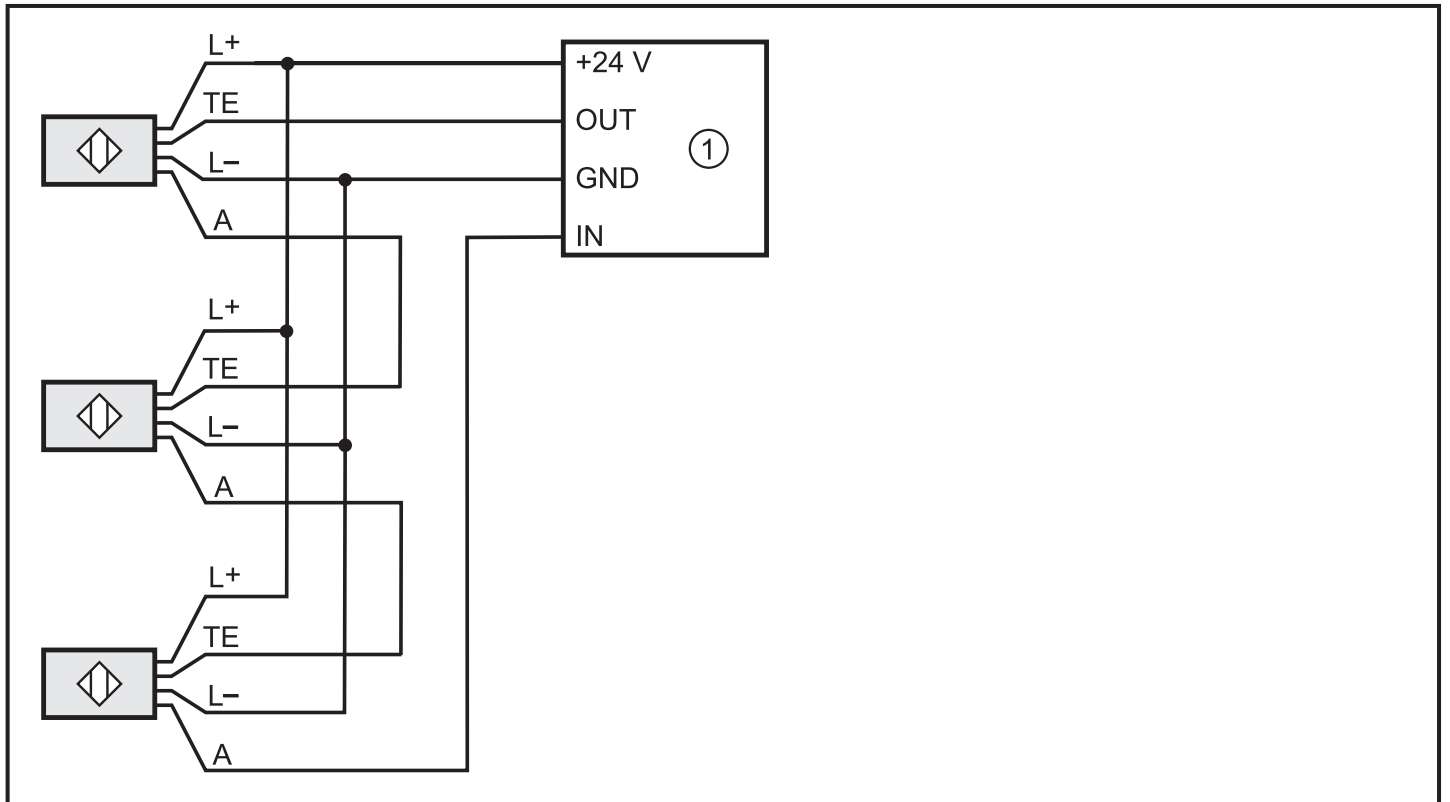

8 Set-up

8.1 Setting aid

For easy and reliable installation the sensor features an optical setting aid to visualise the enable zone.

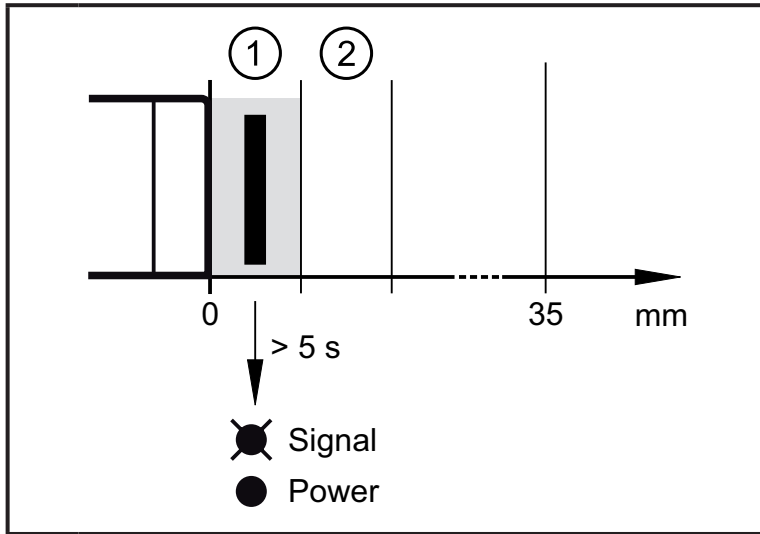

The setting aid is activated by placing a metal object in front of the fail-safe sensor (close range).

After approx. 5 s the yellow LED starts to flash: the setting aid is active.

While this mode is active, the output remains in the safe state ("0").

UK

- 1: close zone
- 2: enable zone

8.2 Determine the enable zone

When the setting aid is active, the enable zone can be determined by moving the target (or the sensor if the target is fixed).

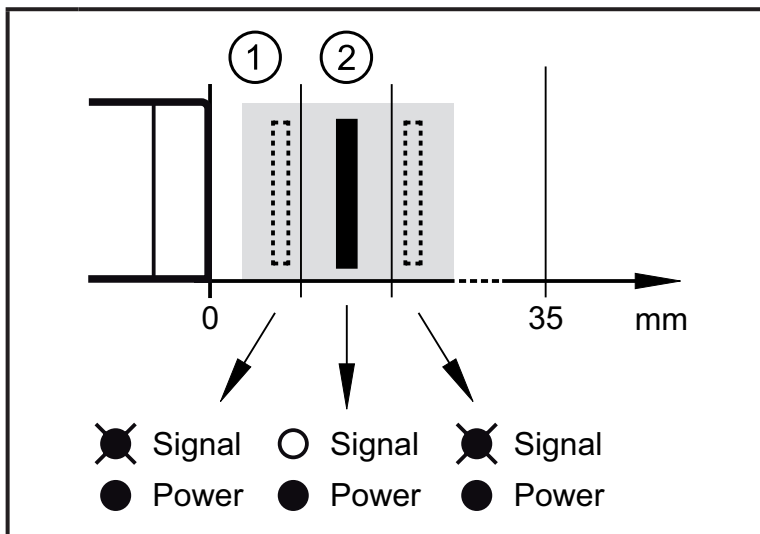

As soon as the target enters the enable zone, the yellow LED goes out.

If the target is just outside the enable zone in either direction the LED starts to flash again.

- 1: close zone
- 2: enable zone

8.3 Deactivate setting aid

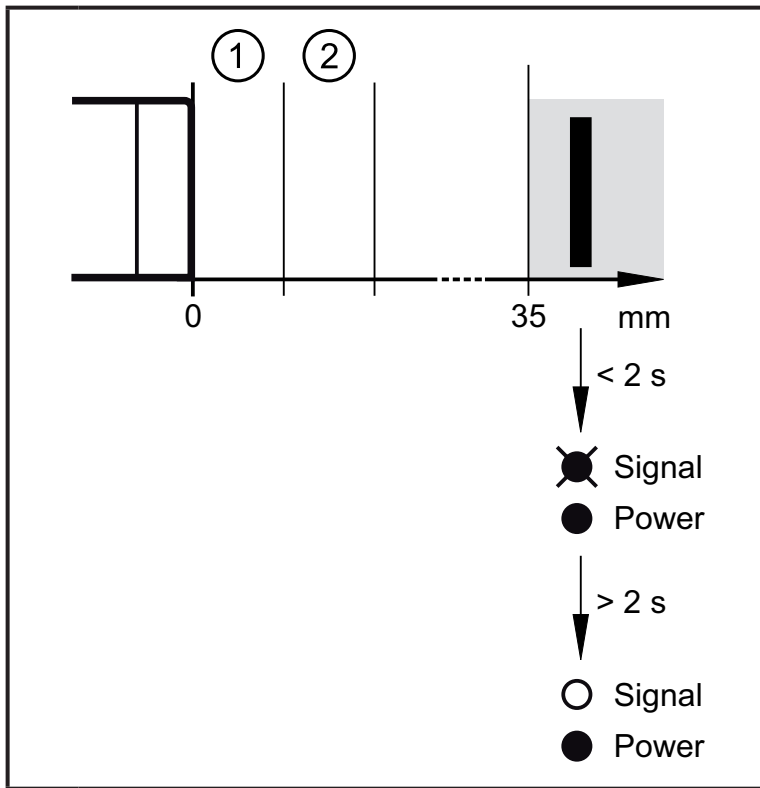

If the sensor is undamped for more than 2 s (> 35 mm), the setting aid is switched off and the yellow LED goes out.

This can also be achieved by power off.

9 Operation

9.1 Sensor signals

The safe state is when at least one of the outputs Logic "0". The fail-safe sensor must be operated with a clock signal on its clock input (TE). The clock input signal must meet the defined time conditions (see figure).

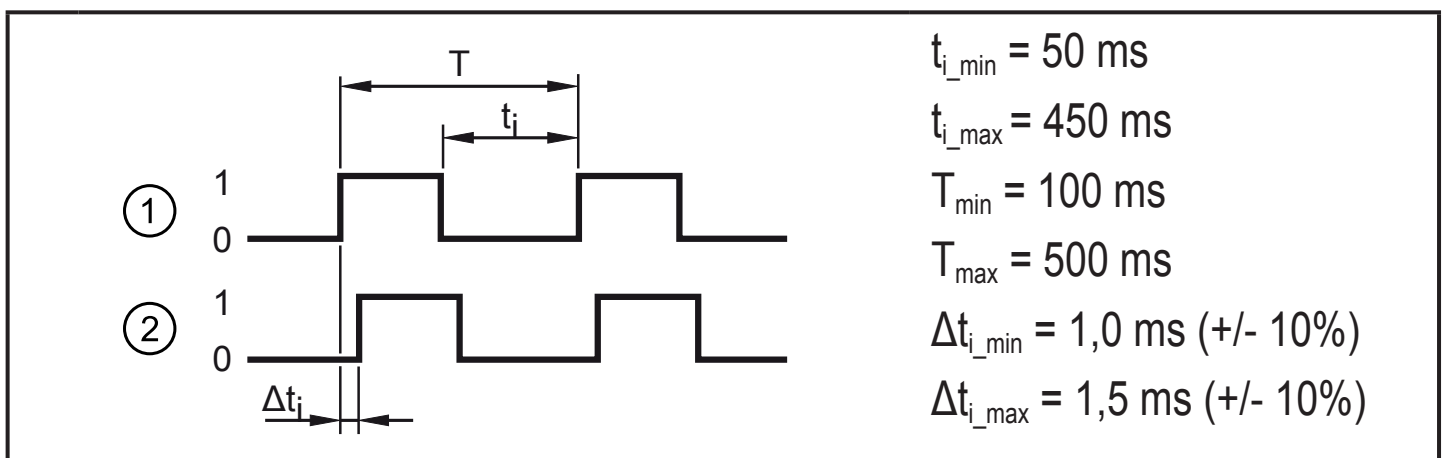

1: clock input (TE)
2: output

9.2 Input characteristics / output characteristics

The electrical input characteristics are compatible with the output characteristics to EN 61131-2 (nominal current 0.1 A and nominal voltage 24 V):

Logic "1"	$\geq 11 \text{ V}, < 30 \text{ V}$	Input current approx. 3 mA
Logic "0"	$\leq 5 \text{ V}$	Leakage current 500 μA
Permissible test pulse duration	$\leq 1.0 \text{ ms}$	

If the target is in the enable zone and there is no sensor fault, the clock input signal is transferred to the output with the delay t_d . The output characteristics are compatible with the input characteristics to EN 61131-2 type 1 or 2:

UK

Logic "1"	$\geq 15 \text{ V}$ $\geq 11 \text{ V}$	2...15 mA 15...30 mA Output impedance typ. 27 Ω
Logic "0"	$\leq 5 \text{ V}$	Leakage current 0 mA (pull-down current typ. 30 mA)

If the target is outside the enable zone, the output is switched off (logic "0").

 Non-observance of the time diagram (e.g. no time offset t_d ; permanently logic "1" → 9.1 Sensor signals) is a fault.

The interface corresponds to interface type B according to the ZVEI position paper "Klassifizierung binärer 24-V-Schnittstellen mit Testung im Bereich der Funktionalen Sicherheit" (Classification of binary 24V interfaces tested with regard to functional safety).

9.3 Cross faults

 Cross faults are detected by the fail-safe sensor and lead to an error message (permanently logic "1"). The pull-down current of the clock generator must not exceed 30 mA as the fail-safe sensor can no longer switch this current. An error message is no longer possible then.

9.4 Operating mode

The length of the preceding undamping determines whether the yellow LED comes on with a delay (→ 9.4.1) or without delay (→ 9.4.2) when a target moves into the enable zone. In any case, the output switches on without delay.

In case of undamping the output switches off and the yellow LED goes out without delay.

In case of damping in the close range the output switches off immediately whereas the yellow LED goes out with a delay of approx. 2 s. With the deactivation of the LED the output is maintained in the safe state (logic "0"). Thus, switching on again in the enable zone is not possible. Enabling is done by undamping (> 35 mm) of more than 2 s or by interrupting the voltage (→ 5.2 Protection against simple defeating).

9.4.1 Delayed switching of the LED

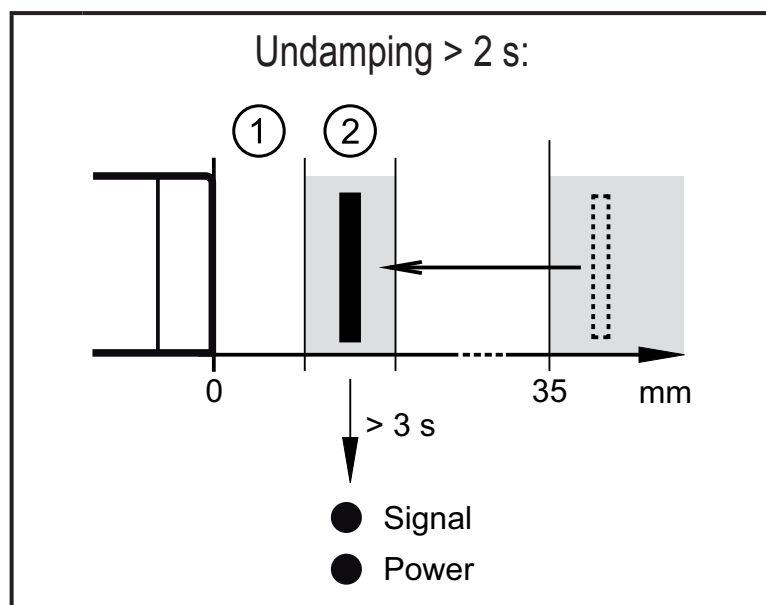

If the target was away from the sensor for more than approx. 2 s (> 35 mm), the yellow LED goes on with a delay of approx. 3 s in case of damping in the enable zone.

This is also the case if the target is in the enable zone when the voltage is switched on.

9.4.2 Switching of the LED without delay

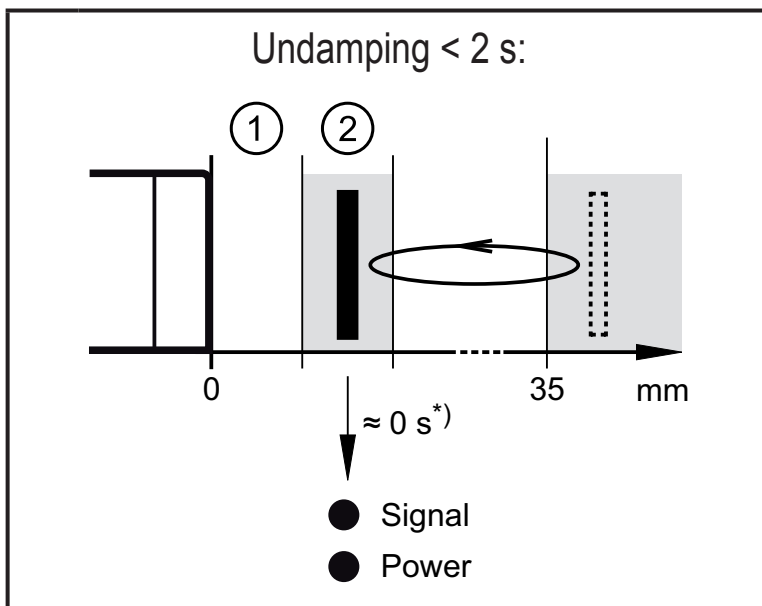

If the target was away from the sensor for less than 2 s (> 3 mm), the yellow LED comes on without delay in case of damping in the enable zone.

*) except for the first start-up

9.5 Response times

(Without response time of the monitoring unit)











Response time on safety request (removal from the enable zone)	≤ 20 ms ¹⁾
Response time when approaching the close range (non safety-related zone)	$\leq T$
Response time when approaching the enable zone (enable time)	typ. 100 ms ≤ 200 ms ²⁾
Response time when switching off the clock input	≤ 2 ms
Response time for enabling to rising edge of TE (damped in the enable zone)	typ. 40 ms max. 100 ms
Response time / risk time for safety-related faults	$\leq T$
Permissible dwell time in the close range	approx. 2 s
Delay time to activate the setting aid (\rightarrow 8.1)	approx. 5 s
Dwell time in the undamped condition (≥ 35 mm) to return into the operating mode (\rightarrow 8.3 Deactivate setting aid)	approx. 2 s

¹⁾ During this time the output is switched off (logic "0").

²⁾ As from this instant the clock input signal is transferred to the output with a delay.

T \rightarrow 9.1 Sensor signals

9.6 LED display

LED		Operating status	Sensor signals
○	Signal	No voltage supply	
○	Power		
○	Signal	Undervoltage	TE_0^1  A_0^1 
⊗	Power		
○	Signal	Overvoltage	TE_0^1  A_0^1 
⊗	Power		
○	Signal	Output switched off (safe state), target outside the enable zone (operating mode) or target in the enable zone (setting aid)	TE_0^1  A_0^1 
●	Power		
●	Signal	Output switched, target in the enable zone (operating mode)	TE_0^1  A_0^1 
●	Power		
⊗	Signal	Output switched off (safe state), target outside the enable zone (setting aid)	TE_0^1  A_0^1 
●	Power		
⊗	Signal	Internal or external fault (→ 11 Troubleshooting)	
○	Power		

10 Technical data

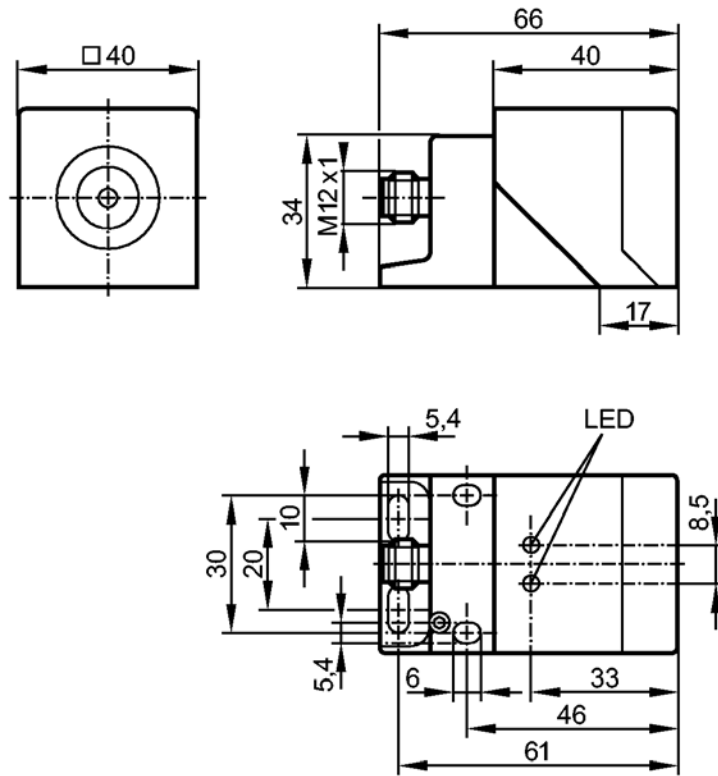

Product characteristics

Fail-safe inductive sensor

Rectangular, plastics

M12 connector

Enable zone 10...20 mm; [nf] non-flush mountable

Complies with the requirements:
EN ISO 13849-1: 2015 category 4 PL e
IEC 61508: SIL 3

Application

Type of operation

continuous operation (maintenance-free)

Electrical data

Electrical design

DC

Operating voltage [V]

24 DC (19.2...30 DC)

Rated insulation voltage [V]

30

Current consumption [mA]

< 15

Protection class

III

Reverse polarity protection

yes

Outputs

Output function

Clock signal

Output data

Interface Typ B

Short-circuit protection

yes

Max. capacitive load CL_max [nF]

20

Range

Enable zone [mm]

10...20

Safe switching off distance s(ar) [mm]	35
--	----

Reaction times

Power-on delay time [s]	5
Response time to safety request [ms]	≤ 20
Response time when approaching the enable zone (enable time) [ms]	≤ 200; typ. 100

Environment

Applications	Class C to EN 60654-1 weatherproof application
Ambient temperature [°C]	-25...70, for service life ≤ 87600 h 10...40, for service life ≤ 175200 h
Rate of temperature change [K/min]	0.5
Max. relative air humidity [%]	5...95, briefly 5...70, permanently
Air pressure [kPa]	80...106
Protection	IP 65 / IP 67; to EN 60529

Tests / approvals

EMC	IEC 60947-5-2	
	IEC 60947-5-3	
	EN 60947-5-2	
	EN 61000-4-2 ESD:	6 kV CD / 8 kV AD
	EN 61000-4-3 HF radiated:	20 V/m
	EN 61000-4-4 Burst:	2 kV
	EN 61000-4-6 HF conducted:	10 V
	EN 61000-4-8:	30 A/m
EN 55011:	class B	
Shock resistance	IEC 60947-5-2	
Vibration resistance	IEC 60947-5-2	

Safety classification

Mission time TM [h]	≤ 175200, (20 years)
Safety-related reliability PFHd [1/h]	1.1E-09

Mechanical data

Mounting	non-flush mountable
Housing materials	PPE; diecast zinc
Weight [kg]	0.355

Displays / operating elements

Display	LED yellow (signal), LED green (power)
---------	--

Electrical connection

Connection	M12 connector; Gold-plated contacts
------------	-------------------------------------

Wiring

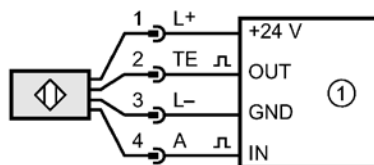

1 = Safety-related logic unit

Remarks

Remarks	Unless stated otherwise, all data refer to the 60x60x1 mm reference target plate to IEC 60947-5-2 (FE360 = mild steel) over the whole temperature range.
Pack quantity [piece]	1

11 Troubleshooting

LED display → 9.6

Problem	Possible cause	Troubleshooting
No LED display	No voltage supply	Apply voltage
Power LED flashes and sensor does not switch	<ul style="list-style-type: none"> • Undervoltage • Overvoltage 	Correct the voltage (→ 10 Technical data)
Power LED off and signal LED flashes	Internal or external fault	<ul style="list-style-type: none"> • Undamp / damp • Power off / on • Replace the unit • Check wiring / connections • Check external electronics (e.g. G150xS or PLC)

UK

12 Maintenance, repair and disposal

If used correctly, no maintenance and repair measures are necessary.

Only the manufacturer is allowed to repair the unit.

After use dispose of the unit in an environmentally friendly way in accordance with the applicable national regulations.

13 Terms and abbreviations

PDDB	Proximity devices with defined behaviour under fault conditions	
PFH (PFH _D)	Probability of (dangerous) Failure per Hour	
PL	Performance Level	PL to EN ISO 13849-1
SIL	Safety Integrity Level	SIL 1-4 to IEC 61508. The higher the SIL, the lower the probability that a safety function will fail.
SIL _{cl}	Safety Integrity Level _{claim limit}	According to IEC 62061
T _M	Mission time	Lifetime to EN 60947-5-3 (= max. service life)