

Pressure and vacuum switches

for control circuits

Type XMJ for detection of a single threshold (fixed differential)

Description, operating principle, setting

Description

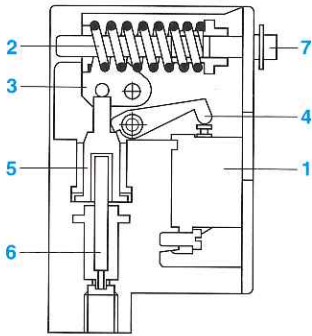

- 1 Snap action contact block
- 2 Adjustment spring for the actuation point
- 3 Mechanical compensating lever
- 4 Operating lever
- 5 Operating piston
- 6 Pressure transducer (diaphragm, piston or metal bellows) which transforms the pressure into an actuating force
- 7 Adjustment screw for setting actuation point

Operating principle

Actuation point

As the fluid pressure within the system rises, a force is transmitted through the transducer 6 which pushes against the spring 2. When this force is strong enough to overcome the spring pressure (as set by compressing it using adjustment screw 7), lever 4 is pivoted by the operating piston 5 and operates the electrical contact 1.

The switch has thus actuated (opening contact 1) on rising pressure at the actuation point which corresponds to a higher or lower pressure value depending upon the compression of spring 2, as adjusted by screw 7.

Reset point

As the fluid pressure falls enough for spring 2 to push back on the transducer 6, its associated lever 4 pivots back and resets the electrical contact 1 of the switch. The reset pressure will always be lower than the actuation pressure, and the difference between them is the natural differential of the switch (contact block differential travel and friction within the switch).

Setting

Setting the switch to actuate at the required value of pressure or vacuum :

- Switches without setting scale : Turn knurled adjustment screw 7 in the required direction as indicated by the + and - markings on the front of the switch body. If a very accurate setting is required, the use of a pressure gauge is recommended.
- Switches with setting scale (showing value of pressure being set) : Turn the knurled adjustment screw 7 in the required direction as indicated by the + and - markings on the front of the switch body, until the scale is reading the value of the actuation pressure required. An index point enables rapid adjustment which can be fine-tuned using a pressure gauge.

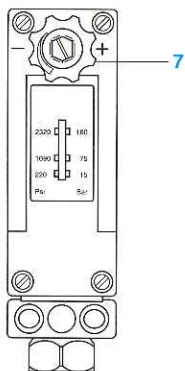
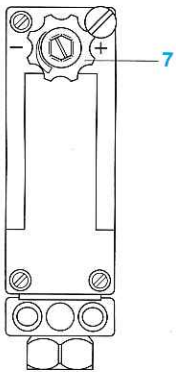

Pressure and vacuum switches

for control circuits

Type XMJ for detection of a single threshold (fixed differential)

Characteristics

Environment

Model		All XMJ switches except XMJ-A050● and XMJ-A115●	XMJ-A050● and XMJ-A115●
Conforming to standards		IEC 337-1, NF C 63-140, VDE 0660-200, CSA C22-2 n° 14.	
Approvals		Standard version : ASE, DEMKO, NEMKO, FI, USSR, BV, DNV, LROS, GL, CSA A300 - Q300 Special version : CSA, fitted with NPT conduit adaptor	-
Protective treatment		Standard version "TC". Special version "TH".	
Ambient air temperature	° C	Operation : - 25...+ 70 . Storage : - 40...+ 70	
Fluids or products controlled		Hydraulic oils, air, fresh water, sea water : (0...+ 70 °C) Hot fluids, corrosive fluids : (0...+ 160 °C)	Hydraulic oils, air, water : (0...+ 70 °C) Corrosive fluids on request
Operating position		All positions	
Vibration resistance		4 g (10...500 Hz) conforming to IEC 68-2-6	5 g (10...500 Hz) to IEC 68-2-6
Shock resistance		100 g conforming to IEC 68-2-27	
Electric shock protection		Class I conforming to IEC 536 and NF C 20-030	
Degree of protection		IP 66 conforming to IEC 529; IP 665 conforming to NF C 20-010	IP 66 conforming to IEC 529. IP 665 conforming to NF C 20-030
Operating rate	operating cycles/min	≤ 30	≤ 60
Mechanical durability	operating cycles	2.5 million (average value for switch set at 2/3 of its operating range)	Dependent on pressure See curve below
Repeat accuracy		< 2 %	Lower point : ± 1.5%. Upper pt. : ± 0.5%
Fluid connections		1/4" BSP female	1/4" BSP female
Cable entry		1 tapped entry for N° 13 cable gland (capacity 9 to 12 mm)	

Contact block characteristics

Rated thermal current	A	10 conforming to IEC 337-1, NF C 63-140, VDE 0660-200, CSA C22-2 n° 14.
Rated insulation voltage	V	~ 500 and --- 600 to IEC 158-1, NF C 20-040 and VDE 0110, ~ and --- 300 to CSA C 22-2 n° 14
Insulation category		Group C conforming to NF C 20-040, VDE 0110
Contact operation		1 C/O single-pole (4 terminal) snap action contact
Resistance across terminals	mΩ	≤ 25 conforming to NF C 93-050 method A or IEC 255-7 category 3
Terminal referencing		Conforming to CENELEC EN 50013
Short-circuit protection		10 A cartridge fuse type gG (gl) conforming to IEC 337-1B, VDE 0660-200
Cabling		Screw and captive cable clamp terminals. Capacity : minimum 1 x 0.2 mm ² , maximum 2 x 2.5 mm ² .

Rated power
conforming to IEC 337-1
Utilisation categories AC-11 and DC-11

Operating rate : 3600 operating cycles per hour
Load factor : 0.5

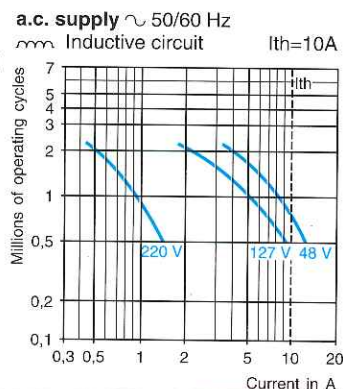

d.c. supply ---
Power broken in W
for 1 million operating cycles

Voltage V	24	48	120
W	31	29	26

Mechanical durability
(XMJ-A050● and XMJ-A115●)

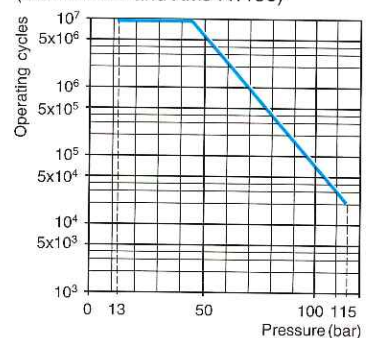

Pressure and vacuum switches

for control circuits

Type XMJ for detection of a single threshold (fixed differential)

Complete switches with 1 C/O single-pole snap action contact



XMJ-A003



XMJ-A115



XMJ-A1157

Diaphragm type pressure switches (without setting scale)

Operating range		Natural differntl. (1)		Max. permissible pressure per cycle	occasional surge	Reference	Weight
low	high	at low setting	at high setting				
bar	bar	bar	bar	bar	bar		kg

Hydraulic oils, air, fresh water, sea water : 0 °C to + 70 °C (2)

0.4	3.5	0.28	0.62	5	20	XMJ-A003	0.495
1	12	0.4	1.5	18	30	XMJ-A012	0.495
2	20	1	3.1	25	40	XMJ-A020	0.495

Hot or corrosive fluids : 0 °C to + 160 °C (2)

0.4	3.5	0.28	0.54	5	20	XMJ-A0035	0.495
1	12	0.4	1.5	18	30	XMJ-A0125	0.495
2	20	1	3.1	25	40	XMJ-A0205	0.495

Diaphragm type pressure switches (with setting scale)

Operating range		Natural differntl. (1)		Max. permissible pressure per cycle	occasional surge	Reference	Weight
low	high	at low setting	at high setting				
bar	bar	bar	bar	bar	bar		kg

Hydraulic oils, air, fresh water, sea water : 0 °C to + 70 °C (2)

0.4	3.5	0.28	0.54	5	20	XMJ-A0037	0.505
1	12	0.4	1.5	18	30	XMJ-A0127	0.505
2	20	1	3.1	25	40	XMJ-A0207	0.505

Hot or corrosive fluids : 0 °C to + 160 °C (2)

0.4	3.5	0.28	0.54	5	20	XMJ-A00375	0.505
1	12	0.4	1.5	18	30	XMJ-A01275	0.505
2	20	1	3.1	25	40	XMJ-A02075	0.505

Metal bellows type pressure switches (without setting scale)

Operating range		Natural differntl. (1)		Max. permissible pressure per cycle	occasional surge	Reference	Weight
low	high	at low setting	at high setting				
bar	bar	bar	bar	bar	bar		kg

Hydraulic oils, air, fresh water, sea water : 0 °C to + 70 °C (2)

13	50	5	10	63	115	XMJ-A050	0.690
20	115	6.5	16	132	260	XMJ-A115	0.690

Metal bellows type pressure switches (with setting scale)

Operating range		Natural differntl. (1)		Max. permissible pressure per cycle	occasional surge	Reference	Weight
low	high	at low setting	at high setting				
bar	bar	bar	bar	bar	bar		kg

Hydraulic oils, air, fresh water, sea water : 0 °C to + 70 °C (2)

13	50	5	10	63	115	XMJ-A0507	0.700
20	115	6.5	16	132	260	XMJ-A1157	0.700

(1) Natural differential : average values.

(2) Materials in contact with the fluid : see page 24.

Pressure and vacuum switches

for control circuits

Type XMJ for detection of a single threshold (fixed differential)

Complete switches with 1 C/O single-pole snap action contact

Piston type pressure switches (without setting scale)

Operating range		Natural differntl. (1)		Max. permissible pressure per cycle	occasional surge	Reference	Weight
low	high	at low setting	at high setting				
bar	bar	bar	bar	bar	bar		kg

Hydraulic oils : 0 °C to + 70 °C (2)

6.5	30	3.5	6.5	60	100	XMJ-A030	0.495
9.5	70	6.5	15	100	150	XMJ-A070	0.495
15	160	10	25	200	300	XMJ-A160	0.495
30	300	16	45	350	450	XMJ-A300	0.495
50	500	25	60	580	600	XMJ-A500	0.495

Fresh water, sea water : 0 °C to + 70 °C (2)

6.5	30	3.5	6.5	60	100	XMJ-A0304	0.495
9.5	70	6.5	15	100	150	XMJ-A0704	0.495
15	160	10	25	200	300	XMJ-A1604	0.495
30	300	16	45	350	450	XMJ-A3004	0.495
50	500	25	60	580	600	XMJ-A5004	0.495

Air : 0 °C to + 70 °C (2)

6.5	30	3.5	6.5	60	100	XMJ-A0308	0.495
9.5	70	6.5	15	100	150	XMJ-A0708	0.495
15	160	10	25	200	300	XMJ-A1608	0.495
30	300	16	45	350	450	XMJ-A3008	0.495
50	500	25	60	580	600	XMJ-A5008	0.495

Hot or corrosive fluids : 0 °C to + 160 °C (2)

6.5	30	3.5	6.5	60	100	XMJ-A0305	0.495
9.5	70	6.5	15	100	150	XMJ-A0705	0.495
15	160	10	25	200	300	XMJ-A1605	0.495
30	300	16	45	350	450	XMJ-A3005	0.495
50	500	25	60	580	600	XMJ-A5005	0.495

Diaphragm type vacuum switches (without setting scale)

Operating range		Natural differntl. (1)		Maximum permissible pressure per cycle	Reference	Weight
low	high	at low setting	at high setting			
bar	bar	bar	bar	bar		kg

Hydraulic oils, air, fresh water, sea water : 0 °C to + 70 °C (2)

-0.22	-1	-0.2	-0.33	0.1	XMJ-A091	0.495
-------	----	------	-------	-----	----------	-------

Hot or corrosive fluids : 0 °C to + 160 °C (2)

-0.22	-1	-0.2	-0.33	0.1	XMJ-A0915	0.495
-------	----	------	-------	-----	-----------	-------

(1) Natural differential : average values.

(2) Materials in contact with the fluid : see page 24.



XMJ-A160

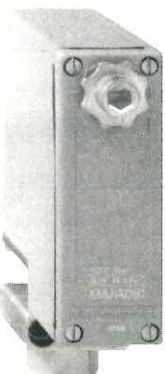

XMJ-A091

Pressure and vacuum switches

for control circuits

Type XMJ for detection of a single threshold (fixed differential)

Complete switches with 1 C/O single-pole snap action contact
Accessories



XMJ-A1607



XMJ-Z01

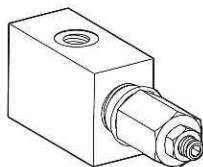

XMJ-Z08



XMJ-Z02



XMJ-Z03

Piston type pressure switches (with setting scale)

Operating range		Natural differntl. (1)		Max. permissible pressure		Reference	Weight kg
low bar	high bar	at low setting bar	at high setting bar	per cycle bar	occasional surge bar		

Hydraulic oils : 0 °C to + 70 °C (2)

6.5	30	3.5	6.5	60	100	XMJ-A0307	0.505
9.5	70	6.5	15	100	150	XMJ-A0707	0.505
15	160	10	25	200	300	XMJ-A1607	0.505
30	300	16	45	350	450	XMJ-A3007	0.505
50	500	25	60	580	600	XMJ-A5007	0.505

Fresh water, sea water : 0 °C to + 70 °C (2)

6.5	30	3.5	6.5	60	100	XMJ-A03074	0.505
9.5	70	6.5	15	100	150	XMJ-A07074	0.505
15	160	10	25	200	300	XMJ-A16074	0.505
30	300	16	45	350	450	XMJ-A30074	0.505
50	500	25	60	580	600	XMJ-A50074	0.505

Air : 0 °C to + 70 °C (2)

6.5	30	3.5	6.5	60	100	XMJ-A03078	0.505
9.5	70	6.5	15	100	150	XMJ-A07078	0.505
15	160	10	25	200	300	XMJ-A16078	0.505
30	300	16	45	350	450	XMJ-A30078	0.505
50	500	25	60	580	600	XMJ-A50078	0.505

Hot or corrosive fluids : 0 °C to + 160 °C (2)

6.5	30	3.5	6.5	60	100	XMJ-A03075	0.505
9.5	70	6.5	15	100	150	XMJ-A07075	0.505
15	160	10	25	200	300	XMJ-A16075	0.505
30	300	16	45	350	450	XMJ-A30075	0.505
50	500	25	60	580	600	XMJ-A50075	0.505

Accessories

Description	Reference	Weight kg	
Lead sealing kit (3)	XMJ-Z01	0.005	
Isolating valve (4) Isolating value : 12 to 200 bar 1/4" BSP female input and output connections	XMJ-Z08	0.590	
Connection adaptors	1/4" BSP male - 1/2" BSP male 1/4" BSP male - 3/8" BSP male	XMJ-Z02 XMJ-Z03	0.120 0.100

(1) Natural differential : average values.

(2) Materials in contact with the fluid : see page 24.

(3) Special cover fixing screw preventing any movement to the setting adjustment screw.

(4) Fitted into the pipe upstream of the pressure switch, the isolating valve will effectively isolate the switch as soon as the pressure rises to an adjustable preset value. The isolating valve is adjusted to close at a pressure within the tolerance of the switch and will reopen as the pressure falls back below this value. Maximum pressure : 250 bar. Settings between 25 - 200 bar are recommended for rapidly changing pressures and between 40 - 200 bar for slow pressure changes.

Other versions

Pressure and vacuum switches for other fluids and specific environments.
Please consult your Regional Sales Office.

Pressure and vacuum switches

for control circuits

Type XMJ for detection of a single threshold (fixed differential)

Operating curves

These curves have been established following arduous dynamic testing (average values)

Pressure switches

XMJ-A003 and XMJ-A003●

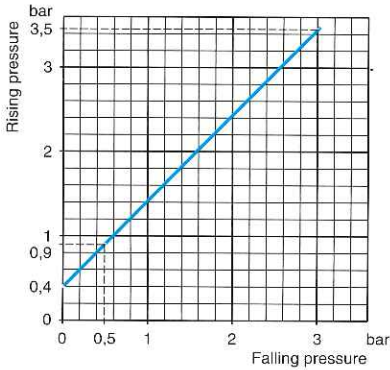

XMJ-A012 and XMJ-A012●

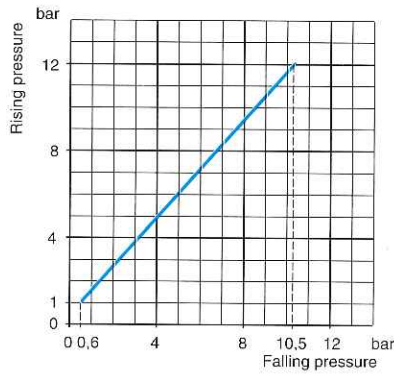

XMJ-A020 and XMJ-A020●

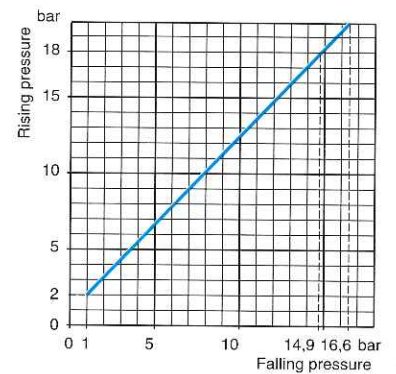

XMJ-A030 and XMJ-A030●

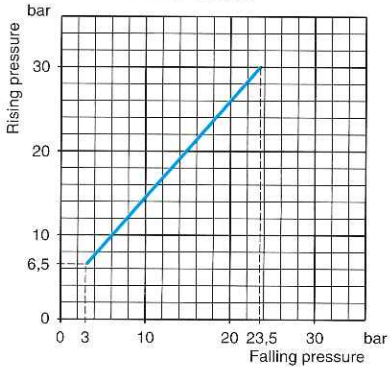

XMJ-A070 and XMJ-A070●

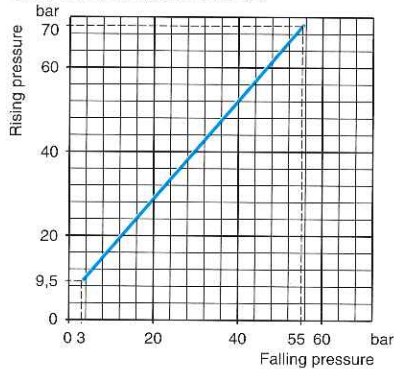

XMJ-A160 and XMJ-A160●

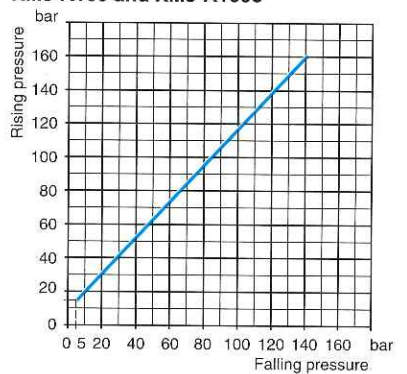

XMJ-A300 and XMJ-A300●

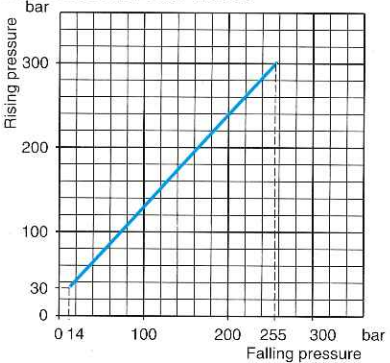

XMJ-A500 and XMJ-A500●

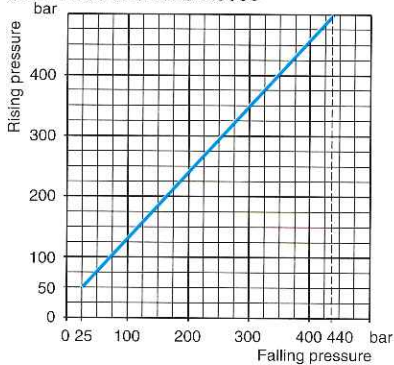

XMJ-A050 and XMJ-A0507

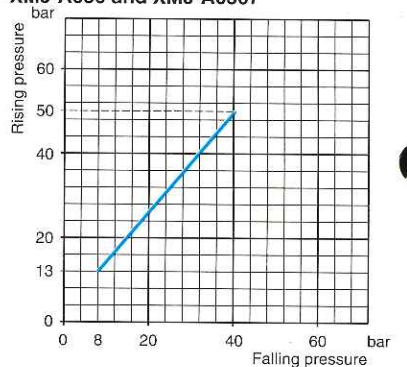

XMJ-A115 and XMJ-A1157

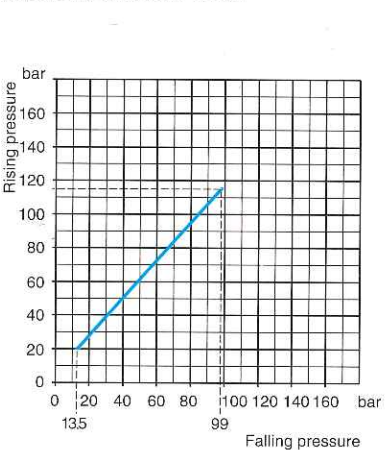

Vacuum switches

XMJ-A091 and XMJ-A0915

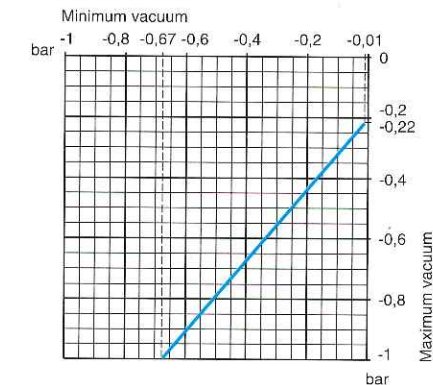

Example of information which may read from a typical operating curve, for pressure switch XMJ-A020

Setting of the actuation point (rising pressure) at a value of 18 bar.
Change of contact state (on falling pressure) will occur at 14.9 bar (differential : 3.1 bar).

Pressure and vacuum switches

for control circuits

Type XMJ for detection of a single threshold (fixed differential)

Dimensions, schemes

Piston type pressure and vacuum switches

Without setting scale

With setting scale

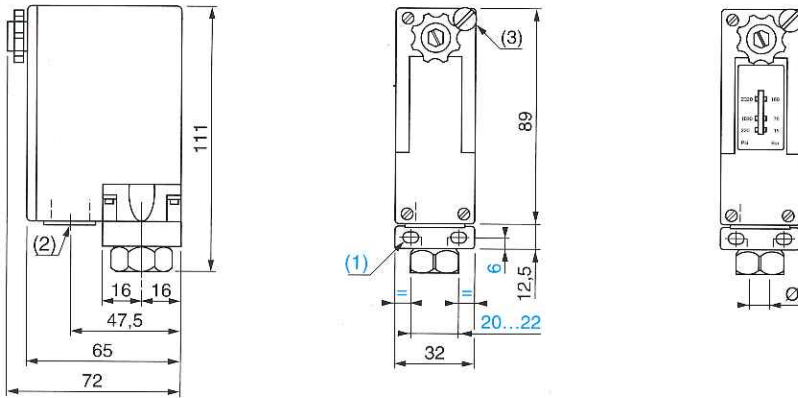

Ø : 1/4" BSP

(1) 2 elongated holes Ø 5.3 x 6.3 (see note below)

(2) 1 tapped entry for N° 13 cable gland

(3) Lead sealing kit (XMJ-Z01), shown fitted

Note : These switches may also be mounted on AM1-PA pre-slotted plates using captive clip-nuts AF1-EA4 or on DZ5-MB mounting rails using sliding clamps DZ5-ME8.

Metal bellows type pressure switches

Without setting scale

With setting scale

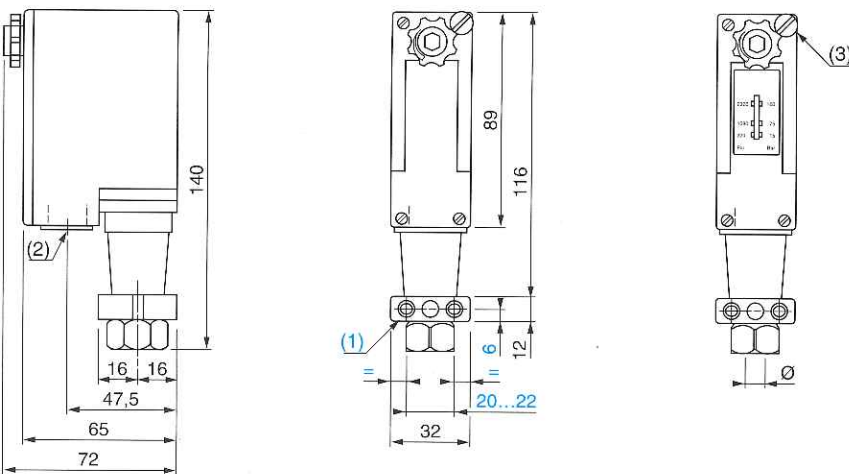

Ø : 1/4" BSP

(1) 2 elongated holes Ø 5.3 x 6.3 (see note below)

(2) 1 tapped entry for N° 13 cable gland

(3) Lead sealing kit (XMJ-Z01), shown fitted

Note : These switches may also be mounted on AM1-PA pre-slotted plates using captive clip-nuts AF1-EA4 or on DZ5-MB mounting rails using sliding clamps DZ5-ME8.

Isolating valve

XMJ-Z08

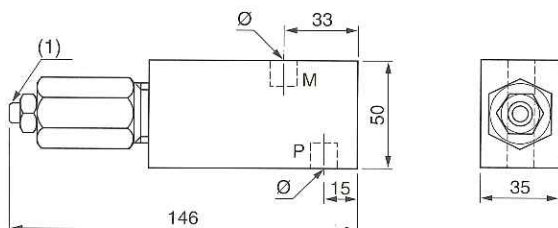

Ø : 1/4" BSP

P : pressure connection

M : operating connection (pressure switch)

(1) Setting adjustment screw

Schemes

Pressure switches

Vacuum switches (1)



(1) At rest, at atmospheric pressure, the contact is actuated.