

# Instrument Pipe & ISO Conversion Fittings

Catalog 4260

May 2014

- aerospace
- climate control
- electromechanical
- filtration
- fluid & gas handling**
- hydraulics
- pneumatics
- process control**
- sealing & shielding



ENGINEERING YOUR SUCCESS.

## Instrument Pipe Fittings

### Introduction

Parker Instrumentation Pipe Fittings are designed as leak-free connections for process, power, instrumentation and general industrial applications. They are manufactured to the highest quality standards and are available in broad ranges of sizes, materials and configurations.

Parker Instrumentation Pipe fittings are made at the Instrumentation Products Division of Parker Hannifin in Huntsville, Alabama. These fittings are manufactured where strict adherence to quality control programs is maintained.

The Parker Quality Program is a measure of the efficiency with which Parker transforms materials, our employee efforts, machinery and information into customer-satisfying products and services.

### Material

Parker Pipe Fittings are standard in steel and brass. Other materials may be special ordered within the Parker Quick Response Department. Straight fittings are manufactured from applicable ASTM bar stock specifications shaped fittings are manufactured from close grain forgings.

## ISO Conversion Fittings

### Introduction

Parker ISO Conversion Fittings are designed to the highest quality standards to allow connections between components and systems which use both NPT and ISO Thread configurations. Conversion fittings are maintained under strict quality control programs.

### Design

Parker ISO Conversion Fittings are designed to the most commonly used ISO thread forms. These thread forms are used where pressure tight joints are either made on threads utilizing a thread sealant or where pressure tight joints utilize a peripheral seal on the face of the mating component.

### Material

Parker ISO Conversion Fittings are standard in stainless steel and brass. Other materials may be special ordered within the Parker Quick Response Department. Straight fittings are manufactured from applicable ASTM bar stock specifications shaped fittings are manufactured from close grain forgings.



### WARNING – USER RESPONSIBILITY

**FAILURE OR IMPROPER SELECTION OR IMPROPER USE OF THE PRODUCTS DESCRIBED HEREIN OR RELATED ITEMS CAN CAUSE DEATH, PERSONAL INJURY AND PROPERTY DAMAGE.**

This document and other information from Parker-Hannifin Corporation, its subsidiaries and authorized distributors provide product or system options for further investigation by users having technical expertise.

The user, through its own analysis and testing, is solely responsible for making the final selection of the system and components and assuring that all performance, endurance, maintenance, safety and warning requirements of the application are met. The user must analyze all aspects of the application, follow applicable industry standards, and follow the information concerning the product in the current product catalog and in any other materials provided from Parker or its subsidiaries or authorized distributors.

To the extent that Parker or its subsidiaries or authorized distributors provide component or system options based upon data or specifications provided by the user, the user is responsible for determining that such data and specifications are suitable and sufficient for all applications and reasonably foreseeable uses of the components or systems.

### Offer of Sale

The items described in this document are hereby offered for sale by Parker-Hannifin Corporation, its subsidiaries or its authorized distributors. This offer and its acceptance are governed by the provisions stated in the detailed "Offer of Sale" elsewhere in this document or available at [www.parker.com/ipdus](http://www.parker.com/ipdus).

© Copyright 2014, Parker Hannifin Corporation. All Rights Reserved



**Parker Hannifin Corporation**  
Instrumentation Products Division  
Huntsville, AL USA  
<http://www.parker.com/ipdus>

## Visual Index

### Pipe Fittings

**Male Hex Nipple**  
MHN ..... page 4



**Male Close Nipple**  
MCN ..... page 4



**Male Hex Long Nipple**  
MHLN ..... page 5



**Female Hex Coupling**  
FHC ..... page 5



**Adapter**  
RA ..... page 6



**Reducing Bushing**  
RB ..... page 6



**Male Elbow**  
ME ..... page 7

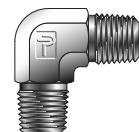

**Female Elbow**  
FE ..... page 7



**Female Elbow 45°**  
FVE ..... page 7



**Street Elbow**  
SE ..... page 8

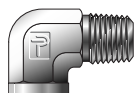

**Street Elbow 45°**  
SVE ..... page 8



**Male Tee**  
MT ..... page 9

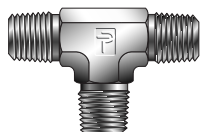

**Female Tee**  
FT ..... page 9



**Street Tee**  
ST ..... page 10



**Male Branch Tee**  
MBT ..... page 10



**Female Cross**  
FX ..... page 10



**Pipe Cap**  
CP ..... page 11



**Hex Head Plug**  
PH ..... page 11



**Hollow Hex Plug**  
PHH ..... page 11



### Straight Thread Adapters

**Hex Head Plug**  
P5ON ..... page 12



**Hollow Hex Plug**  
HP5ON ..... page 12



**Straight Thread Reducer/Expander**  
F5OG5 ..... page 12



**Male SAE Straight Thread to Female NPT Thread**  
GOA ..... page 13



**Male Connector to SAE Straight Thread**  
..... page 13

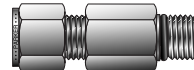

**ISO Conversion Fittings Visual Index**  
..... 14

**Thread and Tube End Size Charts**  
..... pages 27-29

**Pipe Data and Dimensions**  
..... page 30

**Engineering Report: Heat Code Traceability**  
..... page 31

**Offer of Sale**  
..... pages 35-36

Visual Index for ISO Conversion Fittings on page 14.

## Features and Technical Data

Parker Instrument Pipe Fittings are precision machined from forgings for elbows, tees and crosses and from bar stock for straight connectors. They are designed to be used for process control and instrumentation connections between pipe sizes and tube sizes.

## Features

- Quality engineered for instrumentation applications
- Packaged in sealed, clear plastic shrink wrapped boxes for cleanliness
- Working pressures calculated in accordance with Power Piping Code ANSI B31.1 and Refiner Piping Code ANSI B31.3.
- All pipe threads are National Pipe Taper (NPT) and exceed the requirements of ANSI B1.20.1.
- Rolled male threads for extra strength
- Straight bodies machined from applicable ASTM bar stock specifications
- Shapes machined from close grain forgings
- Size ranges from 1/16" through 2" NPT
- Materials – 316 Stainless Steel, Brass and Steel. (Other materials by special order)
- All exposed threads protected to prevent damage

## Pipe Dimensions

Pipe Size	N.P.T. Pipe Thread	R	E Ref.
1/16	1/16 – 27	.38	.11
1/8	1/8 – 27	.38	.19
1/4	1/4 – 18	.56	.28
3/8	3/8 – 18	.56	.41
1/2	1/2 – 14	.75	.50
3/4	3/4 – 14	.75	.62
1	1 – 11-1/2	.94	.94
1-1/4	1-1/4 – 11-1/2	.97	1.25
1-1/2	1-1/2 – 11-1/2	1.00	1.50
2	2 – 11-1/2	1.03	1.94

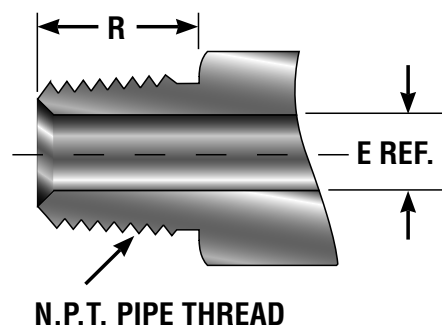

## NPT Threads

The National Pipe Taper (NPT) thread has a thread flank angle of 60° inclusive, and is mainly used in the petrochemical and process industries.

NPT – National Pipe Taper threads for connections where pressure-tight joints are made on the threads utilizing a thread sealant.

## Generic Thread

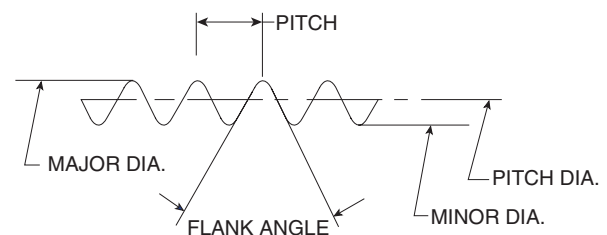

## How To Order

Parker Instrument Pipe Fittings part numbers are constructed from symbols that identify the size and style of the fitting and material used.

The example shown below describes a male hex nipple for 3/8" NPT male pipe and 1/4" NPT male pipe in 316 stainless steel.

### Example: 6-4 MHN-SS

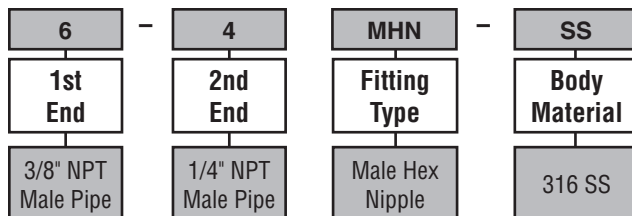

Parker Instrument Pipe Fittings are ordered by part number as listed in this catalog.

**Size:** Pipe thread sizes are designated by the number of sixteenths of an inch. (3/8 NPT pipe = 6/16 = 6)

**Thread Type:** All pipe threads are National Pipe Taper (NPT) unless otherwise designated.

**Straights and Elbows:** Call out the largest pipe end first followed by the smaller pipe size. See MHN example on [page 4](#).

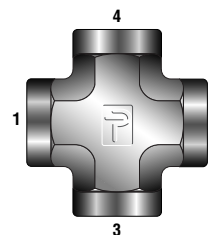

**Tees and Crosses:** For tees that are the same pipe sizes on all ends the size designation is shown below:

**Example:** 6-6-6 FT-B would be a 3/8" NPT Female Tee in brass.

**Example:** 4 FX-SS would be a 1/4" NPT Female Cross in 316 SS.

If a reducing tee or cross were specified, each size must be in sequence. First size the largest run (1 to 2) and then the branch (3 to 4).

**Example:** 6-6-6-4 FX-SS

**Material:** Basic Material Type (B = Brass, SS = 316 Stainless Steel, S = Steel)

**Special Fittings:** If there is any question as to the fitting desired, particularly for special fitting configurations, it is suggested that a customer print be submitted with the fitting request for quote.

**Availability:** Items priced in current Price List 4260 are carried in stock. Price and delivery for non-standard items quoted on request through the quick response department.

## Male Hex Nipple MHN

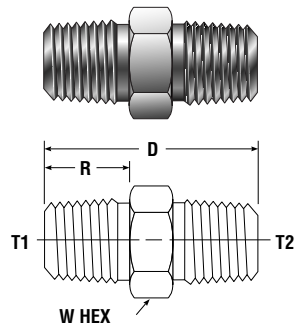

Parker Part No.	NPT Thread Male		W Hex	D (in.)	R (in.)	Working Pressures (PSIG)		
	T <sub>1</sub>	T <sub>2</sub>				Brass	Stainless Steel	Steel
1-1 MHN	1/16	1/16	7/16	1.06	.38	6000	10000	10500
2-1 MHN	1/8	1/16	7/16	1.06	.38	5600	9100	9700
2-2 MHN	1/8	1/8	7/16	1.06	.38	5600	9100	9700
4-1 MHN	1/4	1/16	5/8	1.25	.56/.38	4100	7500	8000
4-2 MHN	1/4	1/8	5/8	1.25	.56/.38	4100	7500	8000
4-4 MHN	1/4	1/4	5/8	1.45	.56	4100	7500	8000
6-1 MHN	3/8	1/16	3/4	1.27	.56/.38	4000	7200	7600
6-2 MHN	3/8	1/8	3/4	1.27	.56/.38	4000	7200	7600
6-4 MHN	3/8	1/4	3/4	1.45	.56	4000	7200	7600
6-6 MHN	3/8	3/8	3/4	1.45	.56	4000	7200	7600
8-2 MHN	1/2	1/8	7/8	1.52	.75/.38	3900	6600	7000
8-4 MHN	1/2	1/4	7/8	1.70	.75/.56	3900	6600	7000
8-6 MHN	1/2	3/8	7/8	1.70	.75/.56	3900	6600	7000
8-8 MHN	1/2	1/2	7/8	1.89	.75	3900	6600	7000
12-2 MHN	3/4	1/8	1-1/8	1.59	.75/.38	3800	6400	6800
12-4 MHN	3/4	1/4	1-1/8	1.78	.75/.56	3800	6400	6800
12-6 MHN	3/4	3/8	1-1/8	1.78	.75/.56	3800	6400	6800
12-8 MHN	3/4	1/2	1-1/8	1.97	.75	3800	6400	6800
12-12 MHN	3/4	3/4	1-1/8	1.97	.75	3800	6400	6800
16-2 MHN	1	1/8	1-3/8	1.78	.94/.38	2700	4600	4900
16-4 MHN	1	1/4	1-3/8	1.97	.94/.56	2700	4600	4900
16-6 MHN	1	3/8	1-3/8	1.97	.94/.56	2700	4600	4900
16-8 MHN	1	1/2	1-3/8	2.16	.94/.75	2700	4600	4900
16-12 MHN	1	3/4	1-3/8	2.09	.94/.75	2700	4600	4900
16-16 MHN	1	1	1-3/8	2.34	.94	2700	4600	4900
20-16 MHN	1-1/4	1	1-3/4	2.45	.97/.94	2000	3500	3700
20-20 MHN	1-1/4	1-1/4	1-3/4	2.48	.97	2000	3500	3700
24-24 MHN	1-1/2	1-1/2	2	2.61	1.00	1800	2900	3100

## Male Close Nipple MCN

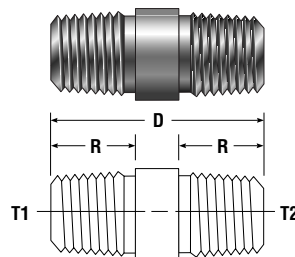

Parker Part No.	NPT Thread Male	D (in.)	R (in.)	Working Pressure (PSIG)		
				Brass	Stainless Steel	Steel
1-1 MCN	1/16	.75	.34	6000	10000	10500
2-2 MCN	1/8	.75	.34	5600	9100	9700
4-4 MCN	1/4	1.13	.49	4100	7500	8000
6-6 MCN	3/8	1.13	.48	4000	7200	7600
8-8 MCN	1/2	1.50	.66	3900	6600	7000
12-12 MCN	3/4	1.50	.66	3800	6400	6800
16-16 MCN	1	1.88	.84	2700	4600	4900

Dimensions for reference only, subject to change.

## Male Hex Long Nipple MHLN

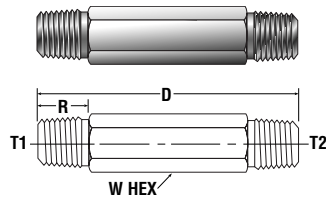

Parker Part No. *	NPT Thread Male		W Hex	D (in.)	R (in.)	Working Pressure (PSIG)		
	T <sub>1</sub>	T <sub>2</sub>				Brass	Stainless Steel	Steel
1-1 MHLN-# †	1/16	1/16	7/16	*	.38	6000	10000	10500
2-2 MHLN-# †	1/8	1/8	7/16	*	.38	5600	9100	9700
2-2 MHLN-# 1.5	1/8	1/8	7/16	1.50	.38	5600	9100	9700
2-2 MHLN-# 2.0	1/8	1/8	7/16	2.00	.38	5600	9100	9700
2-2 MHLN-# 2.5	1/8	1/8	7/16	2.50	.38	5600	9100	9700
4-4 MHLN-# †	1/4	1/4	5/8	*	.56	4100	7500	8000
4-4 MHLN-# 2.0	1/4	1/4	5/8	2.00	.56	4100	7500	8000
4-4 MHLN-# 2.5	1/4	1/4	5/8	2.50	.56	4100	7500	8000
4-4 MHLN-# 3.0	1/4	1/4	5/8	3.00	.56	4100	7500	8000
4-4 MHLN-# 4.0	1/4	1/4	5/8	4.00	.56	4100	7500	8000
6-6 MHLN-# †	3/8	3/8	3/4	*	.56	4000	7200	7600
8-8 MHLN-# †	1/2	1/2	7/8	*	.75	3900	6600	7000
8-8 MHLN-# 2.0	1/2	1/2	7/8	2.00	.75	3900	6600	7000
8-8 MHLN-# 3.0	1/2	1/2	7/8	3.00	.75	3900	6600	7000

# Insert material designator

\*Part Number Example: 8-8 MHLN-SS 3.0

† Specify Length in 0.5 inch increments

## Female Hex Coupling FHC

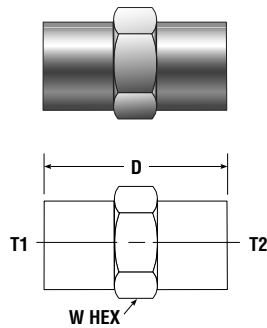

Parker Part No.	NPT Thread Female		W Hex	D (in.)	Working Pressures (PSIG)		
	T <sub>1</sub>	T <sub>2</sub>			Brass	Stainless Steel	Steel
1-1 FHC	1/16	1/16	1/2	.75	4500	7500	8000
2-1 FHC	1/8	1/16	5/8	.75	4000	6400	6800
2-2 FHC	1/8	1/8	5/8	.75	4000	6400	6800
4-1 FHC	1/4	1/16	3/4	.92	4300	6600	7000
4-2 FHC	1/4	1/8	3/4	.94	4300	6600	7000
4-4 FHC	1/4	1/4	3/4	1.13	4300	6600	7000
6-1 FHC	3/8	1/16	7/8	.95	3500	5300	5600
6-2 FHC	3/8	1/8	7/8	1.03	3500	5300	5600
6-4 FHC	3/8	1/4	7/8	1.13	3500	5300	5600
6-6 FHC	3/8	3/8	7/8	1.13	3500	5300	5600
8-2 FHC	1/2	1/8	1-1/8	1.22	3600	5200	5500
8-4 FHC	1/2	1/4	1-1/8	1.38	3600	5200	5500
8-6 FHC	1/2	3/8	1-1/8	1.50	3600	5200	5500
8-8 FHC	1/2	1/2	1-1/8	1.50	3600	5200	5500
12-2 FHC	3/4	1/8	1-3/8	1.39	3000	4300	4600
12-4 FHC	3/4	1/4	1-3/8	1.55	3000	4300	4600
12-6 FHC	3/4	3/8	1-3/8	1.69	3000	4300	4600
12-8 FHC	3/4	1/2	1-3/8	1.88	3000	4300	4600
12-12 FHC	3/4	3/4	1-3/8	1.53	3000	4300	4600
16-2 FHC	1	1/8	1-5/8	1.44	3100	4500	4800
16-4 FHC	1	1/4	1-5/8	1.63	3100	4500	4800
16-6 FHC	1	3/8	1-5/8	1.63	3100	4500	4800
16-8 FHC	1	1/2	1-5/8	1.77	3100	4500	4800
16-12 FHC	1	3/4	1-5/8	1.72	3100	4500	4800
16-16 FHC	1	1	1-5/8	1.89	3100	4500	4800
20-16 FHC	1-1/4	1	2	1.94	2300	3500	3700
20-20 FHC	1-1/4	1-1/4	2	1.94	2300	3500	3700
24-24 FHC	1-1/2	1-1/2	2-3/8	1.94	2100	3200	3400

Dimensions for reference only, subject to change.

## Adapter RA

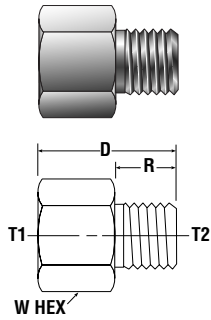

Parker Part No.	NPT Thread		W Hex	D (in.)	R (in.)	Working Pressures (PSIG)		
	Female T <sub>1</sub>	Male T <sub>2</sub>				Brass	Stainless Steel	Steel
	2-1 RA	1/8						
2-2 RA	1/8	1/8	5/8	1.03	.38	4000	6400	6800
4-1 RA	1/4	1/16	3/4	1.20	.38	4300	6600	7000
4-2 RA	1/4	1/8	3/4	1.20	.38	4300	6600	7000
4-4 RA	1/4	1/4	3/4	1.39	.56	4300	6600	7000
6-1 RA	3/8	1/16	7/8	1.25	.38	3500	5300	5600
6-2 RA	3/8	1/8	7/8	1.25	.38	3500	5300	5600
6-4 RA	3/8	1/4	7/8	1.44	.56	3500	5300	5600
6-6 RA	3/8	3/8	7/8	1.44	.56	3500	5300	5600
8-2 RA	1/2	1/8	1-1/8	1.50	.38	3600	5200	5500
8-4 RA	1/2	1/4	1-1/8	1.69	.56	3600	5200	5500
8-6 RA	1/2	3/8	1-1/8	1.69	.56	3600	5200	5500
8-8 RA	1/2	1/2	1-1/8	1.88	.75	3600	5200	5500
12-2 RA	3/4	1/8	1-3/8	1.56	.38	3000	4300	4600
12-4 RA	3/4	1/4	1-3/8	1.75	.56	3000	4300	4600
12-6 RA	3/4	3/8	1-3/8	1.75	.56	3000	4300	4600
12-8 RA	3/4	1/2	1-3/8	1.94	.75	3000	4300	4600
16-2 RA	1	1/8	1-5/8	1.81	.38	3100	4500	4800
16-4 RA	1	1/4	1-5/8	2.00	.56	3100	4500	4800
16-6 RA	1	3/8	1-5/8	2.00	.56	3100	4500	4800
16-8 RA	1	1/2	1-5/8	2.19	.75	3100	4500	4800
16-12 RA	1	3/4	1-5/8	2.19	.75	3100	4500	4800
16-16 RA	1	1	1-5/8	2.38	.94	2700	4500	4800
20-16 RA	1-1/4	1	2	2.47	.94	2300	3500	3700

## Reducing Bushing RB

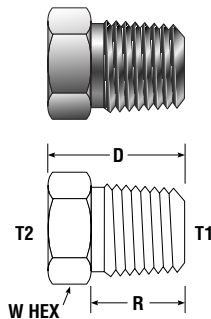

Parker Part No.	NPT Thread		W Hex	D (in.)	R (in.)	Working Pressures (PSIG)		
	Male T <sub>1</sub>	Female T <sub>2</sub>				Brass	Stainless Steel	Steel
	2-1 RB	1/8						
4-1 RB	1/4	1/16	5/8	.86	.56	4100	7500	8000
4-2 RB	1/4	1/8	5/8	.86	.56	3600	6000	6400
6-1 RB	3/8	1/16	3/4	.86	.56	4000	7200	7600
6-2 RB	3/8	1/8	3/4	.86	.56	4000	6400	6800
6-4 RB	3/8	1/4	3/4	.86	.56	3000	5300	5600
8-2 RB	1/2	1/8	7/8	1.11	.75	3900	6600	6800
8-4 RB	1/2	1/4	7/8	1.11	.75	3900	6400	7000
8-6 RB	1/2	3/8	7/8	1.11	.75	2800	4600	4900
12-2 RB	3/4	1/8	1-1/8	1.17	.75	3800	6400	6800
12-4 RB	3/4	1/4	1-1/8	1.17	.75	3800	6400	6800
12-6 RB	3/4	3/8	1-1/8	1.17	.75	3500	5300	5600
12-8 RB	3/4	1/2	1-1/8	1.17	.75	2800	4900	5200
16-2 RB	1	1/8	1-3/8	1.36	.94	2700	4600	4900
16-4 RB	1	1/4	1-3/8	1.36	.94	2700	4600	4900
16-6 RB	1	3/8	1-3/8	1.36	.94	2700	4600	4900
16-8 RB	1	1/2	1-3/8	1.36	.94	2700	4600	4900
16-12 RB	1	3/4	1-3/8	1.36	.94	2500	4200	4500
20-12 RB	1-1/4	3/4	1-3/4	1.47	.97	2000	3500	3700
20-16 RB	1-1/4	1	1-3/4	1.47	.97	2000	3500	3700
24-16 RB	1-1/2	1	2	1.58	1.00	1800	2900	3100
24-20 RB	1-1/2	1-1/4	2	1.58	1.00	1700	2700	2800

Dimensions for reference only, subject to change.



## Male Elbow ME

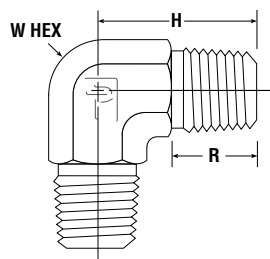
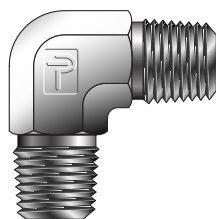

Parker Part No.	NPT Thread Male	W Hex	H (in.)	R (in.)	Working Pressures (PSIG)		
					Brass	Stainless Steel	Steel
1-1 ME	1/16	3/8	.66	.38	5500	9500	10100
2-2 ME	1/8	7/16	.76	.38	5000	9100	9700
4-4 ME	1/4	9/16	1.09	.56	4100	7500	8000
6-6 ME	3/8	3/4	1.22	.56	4000	7200	7600
8-8 ME	1/2	7/8	1.47	.75	3100	5800	6200
12-12 ME	3/4	1-1/16	1.59	.75	3400	6400	6800
16-16 ME	1	1-5/16	1.97	.94	2700	4600	4900

## Female Elbow FE

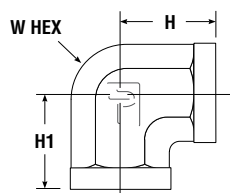
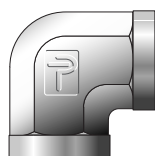

Parker Part No.	NPT Thread Female	W Hex	H (in.)	H <sub>1</sub> (in.)	Working Pressures (PSIG)		
					Brass	Stainless Steel	Steel
1-1 FE	1/16	7/16	.50	.50	3800	7000	7500
2-1 FE	1/8 - 1/16	9/16	.66	.66	2900	5500	5900
2-2 FE	1/8	9/16	.66	.66	2900	5500	5900
4-2 FE	1/4 - 1/8	3/4	.88	.88	2900	5500	5900
4-4 FE	1/4	3/4	.88	.88	3000	5600	6000
6-6 FE	3/8	7/8	1.02	1.02	2700	5000	5300
8-8 FE	1/2	1-1/16	1.23	1.23	2500	4500	4800
12-12 FE	3/4	1-5/16	1.36	1.36	2000	3500	3700
16-16 FE	1	1-5/8	1.63	1.63	2300	3900	4200
20-20 FE	1-1/4	1-7/8	1.70	1.70	1900	3100	3300
24-24 FE	1-1/2	2-1/2	2.08	2.08	1700	2500	2600

## Female Elbow 45° FVE

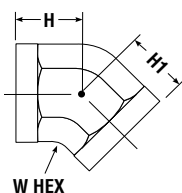

Parker Part No.	NPT Thread Female	W Hex	H (in.)	H <sub>1</sub> (in.)	Working Pressures (PSIG)		
					Brass	Stainless Steel	Steel
1-1 FVE	1/16	7/16	.47	.47	3800	7000	7500
2-2 FVE	1/8	9/16	.47	.47	2900	5500	5900
4-4 FVE	1/4	3/4	.69	.69	3000	5600	6000
6-6 FVE	3/8	7/8	.75	.75	2700	5000	5300
8-8 FVE	1/2	1-1/16	.94	.94	2500	4500	4800
12-12 FVE	3/4	1-5/16	1.00	1.00	2000	3500	3700
16-16 FVE	1	1-5/8	1.19	1.19	2300	3900	4200

Dimensions for reference only, subject to change.

## Street Elbow SE

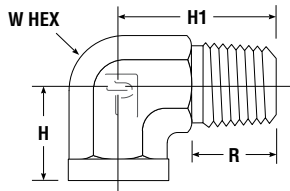
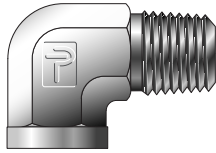

Parker Part No.	NPT Thread		W Hex	H (in.)	H <sub>1</sub> (in.)	R (in.)	Working Pressures (PSIG)		
	Male	Female					Brass	Stainless Steel	Steel
1-1 SE	1/16	1/16	9/16	.66	.72	.38	3800	7000	7500
2-1 SE	1/8	1/16	9/16	.66	.78	.38	3800	7000	7500
2-2 SE	1/8	1/8	9/16	.66	.78	.38	2900	5500	5900
4-1 SE	1/4	1/16	9/16	.66	1.09	.56	3800	7000	7500
4-2 SE	1/4	1/8	9/16	.66	1.09	.56	2900	5500	5900
4-4 SE	1/4	1/4	3/4	.88	1.09	.56	3000	5600	6000
6-1 SE	3/8	1/16	3/4	.88	1.09	.56	3800	7000	7500
6-2 SE	3/8	1/8	3/4	.88	1.22	.58	2900	5500	5900
6-4 SE	3/8	1/4	3/4	.88	1.22	.56	3000	5600	6000
6-6 SE	3/8	3/8	7/8	1.02	1.22	.56	2700	5000	5300
8-2 SE	1/2	1/8	7/8	.95	1.47	.75	2900	5500	5900
8-4 SE	1/2	1/4	7/8	.95	1.47	.75	3000	5600	6000
8-6 SE	1/2	3/8	7/8	1.23	1.47	.75	2700	5000	5300
8-8 SE	1/2	1/2	1-1/16	1.23	1.47	.75	2500	4500	4800
12-2 SE	3/4	1/8	1-1/16	1.00	1.59	.75	2900	5500	5900
12-4 SE	3/4	1/4	1-1/16	1.00	1.59	.75	3000	5600	6000
12-6 SE	3/4	3/8	1-1/16	1.23	1.59	.75	2700	5000	5300
12-8 SE	3/4	1/2	1-1/16	1.23	1.59	.75	2500	4500	4800
12-12 SE	3/4	3/4	1-5/16	1.36	1.59	.75	2000	3500	3700
16-2 SE	1	1/8	1-5/16	1.63	1.97	.94	2700	5500	5900
16-4 SE	1	1/4	1-5/16	1.63	1.97	.94	2700	5600	6000
16-6 SE	1	3/8	1-5/16	1.50	1.97	.94	2700	5000	5300
16-8 SE	1	1/2	1-5/16	1.63	1.97	.94	2500	4500	4800
16-12 SE	1	3/4	1-5/16	1.36	1.97	.94	2000	3500	3700
16-16 SE	1	1	1-5/8	1.63	1.97	.94	2300	3900	4200
20-20 SE	1-1/4	1-1/4	1-7/8	1.70	2.38	.97	1900	3100	3300

## Street Elbow 45° SVE

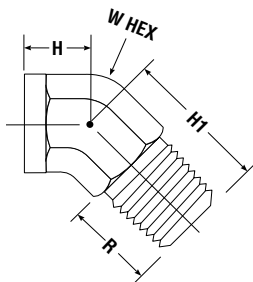
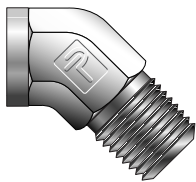

Parker Part No.	NPT Thread		W Hex	H (in.)	H <sub>1</sub> (in.)	R (in.)	Working Pressures (PSIG)		
	Male	Female					Brass	Stainless Steel	Steel
1-1 SVE	1/16	1/16	7/16	.47	.66	.38	3800	7000	7500
2-2 SVE	1/8	1/8	9/16	.47	.72	.38	2900	5500	5900
4-4 SVE	1/4	1/4	3/4	.63	1.05	.56	3000	5600	6000
6-6 SVE	3/8	3/8	7/8	.72	1.06	.56	2700	5000	5300
8-8 SVE	1/2	1/2	1-1/16	.91	1.34	.75	2500	4500	4800
12-12 SVE	3/4	3/4	1-5/16	.97	1.38	.75	2000	3500	3700
16-16 SVE	1	1	1-5/8	1.13	1.72	.94	2300	3900	4200

Dimensions for reference only, subject to change.

## Male Tee MT

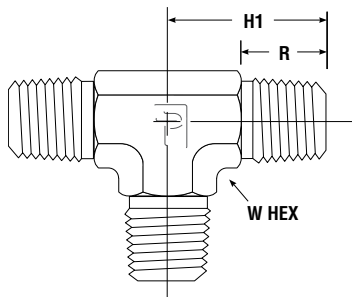
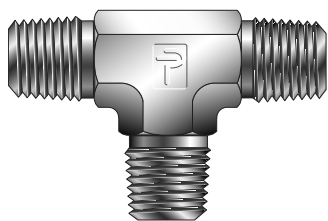

Parker Part No.	NPT Thread Male	W Hex	H <sub>1</sub> (in.)	R (in.)	Working Pressures (PSIG)		
					Brass	Stainless Steel	Steel
1-1-1 MT	1/16	5/16	.72	.38	5500	9500	10100
2-2-2 MT	1/8	7/16	.76	.38	5000	9100	9700
4-4-4 MT	1/4	9/16	1.09	.56	4100	7500	8000
6-6-6 MT	3/8	3/4	1.22	.56	4000	7200	7600
8-8-8 MT	1/2	7/8	1.47	.75	3100	5800	6200
12-12-12 MT	3/4	1-1/16	1.59	.75	3400	6400	6800
16-16-16 MT	1	1-5/16	1.97	.94	2700	4600	4900
20-20-20 MT	1-1/4	1-5/8	2.22	.97	2000	3500	3700
24-24-24 MT	1-1/2	1-7/8	2.64	1.00	1800	2900	3100

## Female Tee FT

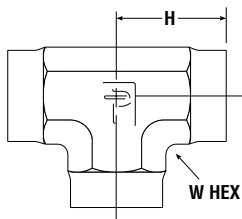
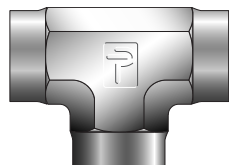

Parker Part No.	NPT Thread Female	W Hex	H (in.)	Working Pressures (PSIG)		
				Brass	Stainless Steel	Steel
1-1-1 FT	1/16	7/16	.50	3800	7000	7500
2-2-2 FT	1/8	9/16	.66	2900	5500	5900
4-4-4 FT	1/4	3/4	.88	3000	5600	6000
6-6-6 FT	3/8	7/8	1.02	2700	5000	5300
8-8-8 FT	1/2	1-1/16	1.23	2500	4500	4800
12-12-12 FT	3/4	1-5/16	1.36	2000	3500	3700
16-16-16 FT	1	1-5/8	1.63	2300	3900	4200
20-20-20 FT	1-1/4	1-7/8	1.70	1900	3100	3300
24-24-24 FT	1-1/2	2-1/2	2.08	1700	2500	3600

Dimensions for reference only, subject to change.

## Street Tee ST

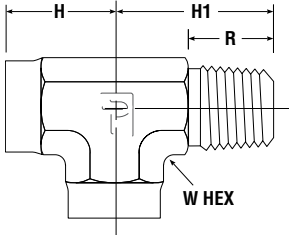
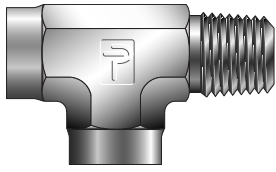

Parker Part No.	NPT Thread		W Hex	H (in.)	H <sub>1</sub> (in.)	R (in.)	Working Pressures (PSIG)		
	Male	Female					Brass	Stainless Steel	Steel
1-1-1 ST	1/16	1/16	7/16	.50	.72	.38	3800	7000	7500
2-2-2 ST	1/8	1/8	9/16	.66	.78	.38	2900	5500	5900
4-4-4 ST	1/4	1/4	3/4	.88	1.09	.56	3000	5600	6000
6-6-6 ST	3/8	3/8	7/8	1.02	1.22	.56	2700	5000	5300
8-8-8 ST	1/2	1/2	1-1/16	1.23	1.47	.75	2500	4500	4800
12-12-12 ST	3/4	3/4	1-5/16	1.36	1.59	.75	2000	3500	3700
16-16-16 ST	1	1	1-5/8	1.63	1.97	.94	2300	3900	4200

## Male Branch Tee MBT

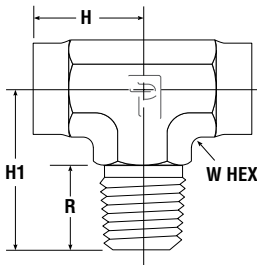
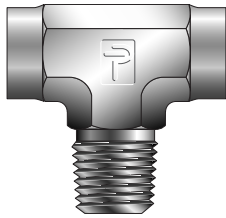

Parker Part No.	NPT Thread		W Hex	H (in.)	H <sub>1</sub> (in.)	R (in.)	Working Pressures (PSIG)		
	Male	Female					Brass	Stainless Steel	Steel
1-1-1 MBT	1/16	1/16	7/16	.50	.72	.38	3800	7000	7500
2-2-2 MBT	1/8	1/8	9/16	.66	.78	.38	2900	5500	5900
4-4-4 MBT	1/4	1/4	3/4	.88	1.09	.56	3000	5600	6000
6-6-6 MBT	3/8	3/8	7/8	1.02	1.22	.56	2700	5000	5300
8-8-8 MBT	1/2	1/2	1-1/16	1.23	1.47	.75	2500	4500	4800
12-12-12 MBT	3/4	3/4	1-5/16	1.36	1.59	.75	2000	3500	3700
16-16-16 MBT	1	1	1-5/8	1.63	1.97	.94	2300	3900	4200

## Female Cross FX

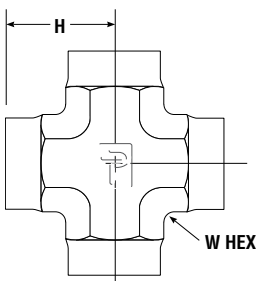
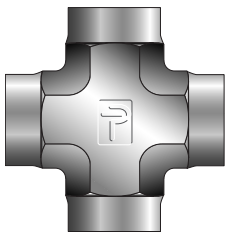

Parker Part No.	NPT Thread Female	W Hex	H (in.)	Working Pressures (PSIG)		
				Brass	Stainless Steel	Steel
1 FX	1/16	7/16	.50	3800	7000	7500
2 FX	1/8	9/16	.66	2900	5500	5900
4 FX	1/4	3/4	.88	3000	5600	6000
6 FX	3/8	7/8	1.06	2700	5000	5300
8 FX	1/2	1-1/16	1.23	2500	4500	4800
12 FX	3/4	1-5/16	1.36	2000	3500	3700
16 FX	1	1-5/8	1.63	2300	3900	4200

Dimensions for reference only, subject to change.

## Pipe Cap CP

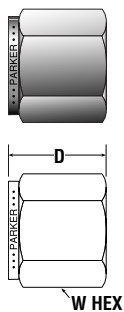

Parker Part No.	NPT Thread Female	W Hex	D (in.)	Working Pressures (PSIG)		
				Brass	Stainless Steel	Steel
1 CP	1/16	7/16	.50	4500	7500	8000
2 CP	1/8	9/16	.75	4000	6400	6800
4 CP	1/4	3/4	.91	4300	6600	7000
6 CP	3/8	7/8	1.03	3500	5300	5600
8 CP	1/2	1-1/16	1.34	3600	5200	5500
12 CP	3/4	1-1/4	1.44	3000	4300	4600
16 CP	1	1-5/8	1.63	3100	4500	4800

## Hex Head Plug PH

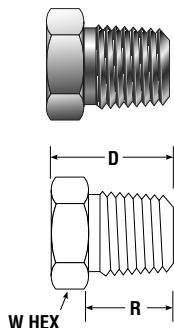

Parker Part No.	NPT Thread Male	W Hex	D (in.)	R (in.)	Working Pressures (PSIG)		
					Brass	Stainless Steel	Steel
1 PH	1/16	3/8	.54	.38	6000	10000	10500
2 PH	1/8	7/16	.56	.38	5600	9100	9700
4 PH	1/4	9/16	.75	.56	4100	7500	8000
6 PH	3/8	11/16	.78	.56	4000	7200	7600
8 PH	1/2	7/8	.97	.75	3900	6600	7000
12 PH	3/4	1-1/16	1.06	.75	3800	6400	6800
16 PH	1	1-5/16	1.25	.94	2700	4600	4900

## Hollow Hex Plug PHH

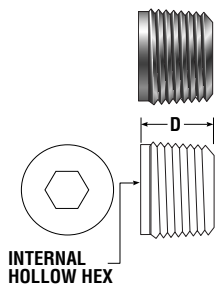

Parker Part No.	NPT Thread Male	W Internal Hex	D (in.)	Working Pressures (PSIG)		
				Brass	Stainless Steel	Steel
1 PHH	1/16	5/32	.30	6000	10000	10500
2 PHH	1/8	3/16	.30	5600	9100	9700
4 PHH	1/4	1/4	.47	4100	7500	8000
6 PHH	3/8	5/16	.47	4000	7200	7600
8 PHH	1/2	3/8	.61	3900	6600	7000
12 PHH	3/4	9/16	.62	3800	6400	6800
16 PHH	1	5/8	.77	2700	4600	4900

Dimensions for reference only, subject to change.

## Hex Head Plug P50N

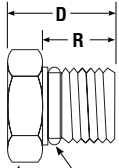
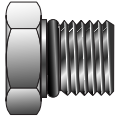

W HEX "O" RING

Parker Part No.	Interchanges With	Port Thd UN/UNF-2A	W Hex	D (in.)	R (in.)	*D <sub>2</sub> Drill (in.)	*L <sub>2</sub> (in.)	O-Ring
4 P50N	4 PST	7/16-20	9/16	0.67	0.36	0.203	0.41	3-904
6 P50N	6 PST	9/16-18	11/16	0.73	0.39	0.297	0.44	3-906
8 P50N	8 PST	3/4-16	7/8	0.80	0.44	0.422	0.44	3-908
12 P50N	12 PST	1-1/16-12	1-1/4	1.09	0.59	0.656	0.59	3-912
16 P50N	16 PST	1-5/16-12	1-1/2	1.13	0.59	0.875	0.50	3-916

\*D<sub>2</sub> drill and L<sub>2</sub> depth are optional manufacturing method per SAE.

## Hollow Hex Plug HP50N

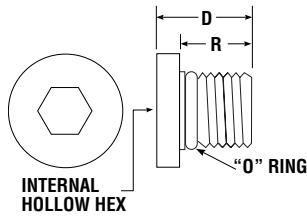
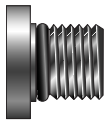

Parker Part No.	Interchanges With	Port Thd UN/UNF-2A	Internal Hex	R (in.)	D (in.)	X Dia. (in.)	O-Ring
4 HP50N	4 HPST	7/16-20	3/16	0.36	0.47	0.56	3-904
6 HP50N	6 HPST	9/16-18	1/4	0.39	0.50	0.69	3-906
8 HP50N	8 HPST	3/4-16	5/16	0.44	0.58	0.88	3-908
12 HP50N	12 HPST	1-1/16-12	9/16	0.59	0.77	1.25	3-912
16 HP50N	16 HPST	1-5/16-12	5/8	0.59	0.77	1.50	3-916

## Straight Thread Reducer/Expander F50G5

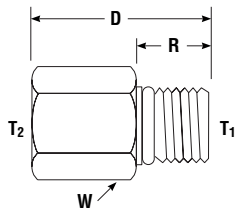
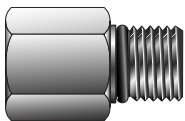

Parker Part No.	Interchanges With	T <sub>2</sub> Port THD UN/UNF-2B	T <sub>1</sub> Port THD UN/UNF-2A	W Hex	*D <sub>2</sub> Drill (in.)	D (in.)	R (in.)	O-Ring
6-4 F50G5	6-RBST-4	7/16-20	9/16-18	11/16	.297	1.03	.36	3-904
8-4 F50G5	8-RBST-4	7/16-20	3/4-16	7/8	.375	1.09	.36	3-904
12-8 F50G5	12-RBST-8	3/4-16	1-1/16-12	1-1/4	.625	1.00	.44	3-908
16-12 F50G5	16-RBST-12	1-1/16-12	1-5/16-12	1-1/2	.750	1.75	.59	3-912

\*D<sub>2</sub> drill is optional manufacturing method per SAE.

Dimensions for reference only, subject to change.

## Male SAE Straight Thread to Female NPT Thread GOA

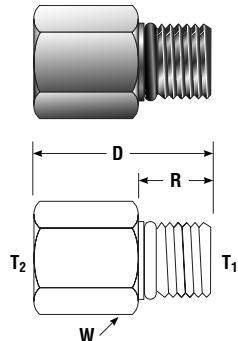

Parker Part No.	Interchanges With	T <sub>1</sub> Straight Thread Size	T <sub>2</sub> - NPT Female Pipe Size	D (in.)	R (in.)	E Minimum Opening (in.)	W Hex	ST O-Ring Uniform Size #
<b>4-4 GOA</b>	4SAE-7-4	7/16-20	1/4	1.19	.36	.20	3/4	3-904
<b>6-6 GOA</b>	6SAE-7-6	9/16-18	3/8	1.26	.39	.30	7/8	3-906
<b>8-8 GOA</b>	8SAE-7-8	3/4-16	1/2	1.50	.44	.39	1-1/8	3-908
<b>12-12 GOA</b>	12SAE-7-12	1-1/16-12	3/4	1.83	.59	.66	1-1/4	3-912
<b>16-16 GOA</b>	16SAE-7-16	1-5/16-12	1	1.88	.59	.88	1-5/8	3-916

Includes O-ring.

## Male Connector to SAE Straight Thread

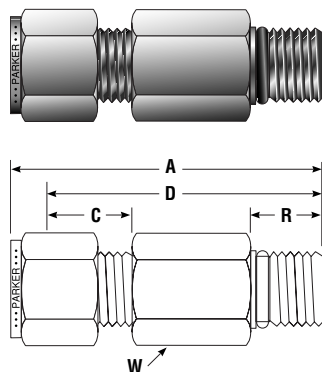

Parker CPI™ Part No.	Parker A-LOK® Part No.	Interchanges With	Tube O.D.	Straight Thread Size	W Hex	A† (in.)	C† (in.)	D (in.)	R (in.)	O-Ring Dash No.
<b>4-4 ZH3BA</b>	<b>4-4 ZH3LA</b>	400-IL-4ST	1/4	7/16-20	9/16	2.26	.70	1.97	.36	3-904
<b>5-5 ZH3BA</b>	<b>5-5 ZH3LA</b>	500-IL-5ST	5/16	1/2-20	5/8	2.32	.73	2.03	.36	3-905
<b>6-6 ZH3BA</b>	<b>6-6 ZH3LA</b>	600-IL-6ST	3/8	9/16-18	11/16	2.48	.76	2.19	.39	3-906
<b>8-8 ZH3BA</b>	<b>8-8 ZH3LA</b>	810-IL-8ST	1/2	3/4-16	7/8	2.99	.87	2.58	.44	3-908
<b>10-10 ZH3BA</b>	<b>10-10 ZH3LA</b>	1010-IL-10ST	5/8	7/8-14	1	3.34	.87	2.94	.50	3-910
<b>12-12 ZH3BA</b>	<b>12-12 ZH3LA</b>	1210-IL-12ST	3/4	1-1/16-12	1-1/4	3.88	.87	3.48	.59	3-912
<b>14-14 ZH3BA</b>	<b>14-14 ZH3LA</b>	1410-IL-14ST	7/8	1-3/16-12	1-3/8	4.07	.87	3.67	.59	3-914
<b>16-16 ZH3BA</b>	<b>16-16 ZH3LA</b>	1610-IL-16ST	1	1-5/16-12	1-1/2	4.35	1.05	3.86	.59	3-916

Includes body, nut, ferrule and O-ring.  
†Average value.

## O-Ring Seals

All standard O-Rings are Nitrile material, 70 Durometer hardness.  
For other materials state material after part number.

Dimensions for reference only, subject to change.

## Visual Index

**Visual Index for Instrument Pipe Fittings**  
.....page 1

**ISO Fitting Nomenclature**  
.....page 15

**Typical Fastening Threads**  
.....page 16

**BSPP Thread Forms**  
.....page 17

### ISO Conversion Fittings

**NPT Male/ BSP Taper Male**  
.....page 18

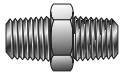

**NPT Male/BSPP Male**  
.....page 18

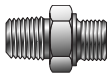

**NPT Female/ BSP Taper Male**  
.....page 18

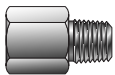

**NPT Female/BSPP Male**  
.....page 19



**BSP Taper Female/ NPT Male**  
.....page 19

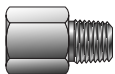

**BSPP Female/NPT Male**  
.....page 19

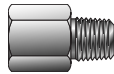

**BSP Taper Male Hex Pipe Plug**  
.....page 20



**BSPP Parallel Male Hex Pipe Plug**  
.....page 20



### ISO Thread/ Fractional Tube Connectors

**BSP Taper Male Connector**  
.....page 21

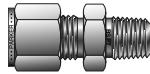

**BSPP Male Connector**  
.....page 21

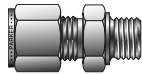

**BSP Taper Female Connector**  
.....page 22

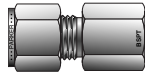

**BSPP Female Gauge Connector**  
.....page 22

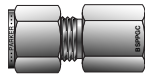

**BSP Taper Male Elbow**  
.....page 22

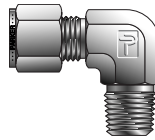

**BSPP Male Elbow (Positionable)**  
.....page 23

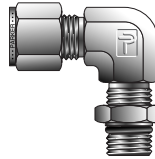

**BSPP Male Run Tee (Positionable)**  
.....page 23

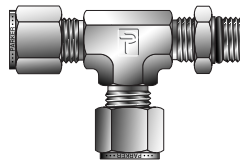

**BSPP Male Branch Tee (Positionable)**  
.....page 24

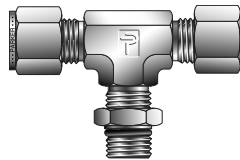

**BSP Taper Male Adapter**  
.....page 24

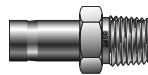

**BSPP Male Adapter**  
.....page 25

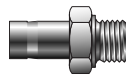

**BSP Taper Female Adapter**  
.....page 25

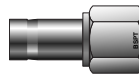

**BSPP Female Adapter**  
.....page 25

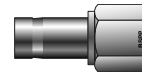

**BSPP Female Gauge Adapter**  
.....page 26

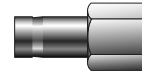

### Sealing Washers

**Bonded Seals (Stainless)**  
.....page 26



**Copper Washers/Male**  
.....page 26



**Copper Washers/Female**  
.....page 26



**Thread and Tube End Size Charts**  
.....pages 27-29

**Pipe Data and Dimensions Chart**  
.....page 30

**Engineering Report: Heat Code Traceability**  
.....page 31

**Offer of Sale**  
.....pages 35-36

Visual Index for Instrument Pipe Fittings on page 1.



## Parker ISO Fitting Nomenclature

Parker ISO Adapters utilize the same basic part numbering system that you are already familiar with from our CPI™ and A-LOK® Catalogs. To specify a Parker Instrumentation Connector with an ISO thread form, simply suffix the **size designator** with the **thread form designator** as illustrated.

Build a **CPI™** or **Pipe** part number by filling in the following boxes:

<b>(A)</b> Port #1 Size Designator	<b>(B)</b> Thread Designator	–	<b>(A)</b> Port #2 Size Designator	<b>(B)</b> Thread Designator	–	<b>(C)</b> Shape Designator	–	<b>(D)</b> Material Designator
--	------------------------------------	---	--	------------------------------------	---	-----------------------------------	---	--------------------------------------

Build an **A-LOK®** part number by filling in the following boxes:

<b>(A)</b> Port #1 Size Designator	<b>(C)</b> Shape Designator	<b>(A)</b> Port #2 Size Designator	<b>(B)</b> Thread Designator	–	<b>(D)</b> Material Designator
--	-----------------------------------	--	------------------------------------	---	--------------------------------------

### (A) Port Size Designators:

Port sizes are incremented by 1/16"  
and only the numerator is required to  
specify a size in a part number.

1 = 1/16"	6 = 3/8"
2 = 1/8"	8 = 1/2"
3 = 3/16"	10 = 5/8"
4 = 1/4"	12 = 3/4"
5 = 5/16"	16 = 1" (larger sizes available)

### (B) Thread Type Designators:

Leave **Blank**: Fractional Tube Size

**N\*** = NPT per ANSI B1.20.1

**K** = ISO Taper per; ISO 7/1, BS21, JIS B0203, DIN 2999

**R** = ISO Parallel per; ISO 228/1+2, DIN 3852 Form A, BS2779 (BSPP), JIS B0202

**BR** = ISO Parallel per; ISO 228/1+2, DIN 3852 Form B, BS2779 (BSPP), JIS B0202

**GC** = ISO Parallel, Female Gauge connector

\* N thread type designator is only required for A-LOK® nomenclature

### (C) Body Shape Designator:

**FBZ** = CPI™ Male Connector

**MSC** = A-LOK® Male Connector

**RA** = Pipe Reducing Adapter

**MHN** = Pipe Male Hex Nipple

See Catalog for further detail

### (D) Material Designators:

**SS** = Stainless Steel for CPI™ and Pipe Fittings

**316** = Stainless Steel for A-LOK®

**B** = Brass

Material	Standard
Stainless Steel	ASTM A276 ASME SA 479
Brass	ASTM B16 ASTM B 453

## Sealing

**BSP Taper** threads require the use of a thread sealant. **BSPP threads** require a sealing washer. This washer may either be a metal gasket (copper is standard) or a "bonded seal" (elastomer bonded to a metal retaining washer). The **BSPP**, form "A" requires the use of a bonded seal ([page 26](#)). The BSPP, form "B" (cutting face) may be used with or without a sealing washer. For applications where the cutting face may not seal or where galling is a potential problem, the use of a washer is suggested.

**Examples:** The Thread Type Designators have been highlighted in the following examples for easy recognition:

4-4**K** FBZ-SS 1/4" CPI™ tube fitting by 1/4" BSPT pipe thread

6-4**R** RA-SS 3/8" female NPT by 1/4" BSPP (form A) reducing adapter  
A bonded seal should be used with this fitting ([page 26](#)).

6MSC4**BR**-316 3/8" A-LOK® tube fitting by 1/4" BSPP (form B)  
A copper washer should be used with this fitting ([page 26](#)).

## Typical Fastening Threads

### BSP threads

BSPP Parallel and BSP Taper threads have a thread flank angle of 55° inclusive.

**BSPP** – British Standard Pipe Parallel threads for tubes and fittings where pressure-tight joints are not made on the thread, i.e., a peripheral seal is used.

**BSP Taper** – British Standard Pipe Taper threads for tubes and fittings where pressure-tight joints are made on the threads.

### Comparison of Thread Forms

NPT Thread Size	Threads per Inch	BSPP	BSPT	Threads per Inch
		Thread Size		
1/8	27	1/8	1/8	28
1/4	18	1/4	1/4	19
3/8	18	3/8	3/8	19
1/2	14	1/2	1/2	14
3/4	14	3/4	3/4	14
1	11 1/2	1	1	11
1 1/4	11 1/2	1 1/4	1 1/4	11
1 1/2	11 1/2	1 1/2	1 1/2	11

### Generic Thread

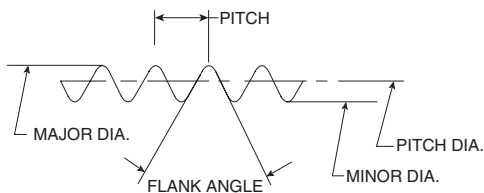

### American Standard Pipe Thread (NPT)

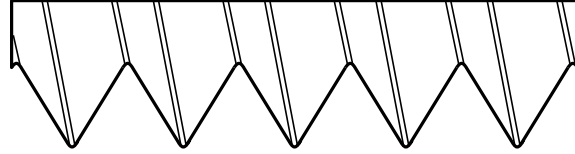

60° inclusive thread flank angle

- Pitch measured in inches
- Truncation of root and crest are flat
- Taper angle 1°47'

### (ISO 7/1)

### BSPT

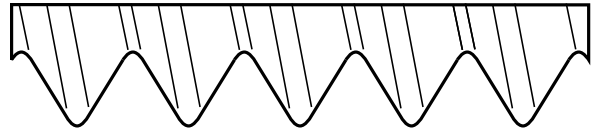

55° inclusive thread flank angle

- Pitch measured in inches
- Truncation of root and crest are round
- Taper angle 1°47'

### (ISO 228/1)

### BSPP

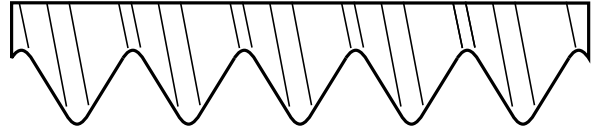

55° inclusive thread flank angle

- Pitch measured in inches
- Truncation of root and crest are round
- Diameter measured in inches

## BSPP Thread Forms

### Form A

A self centering taper is used at the hex which centers a “bonded” washer (usually metal and elastomer) to seal to the surface surrounding the female thread.

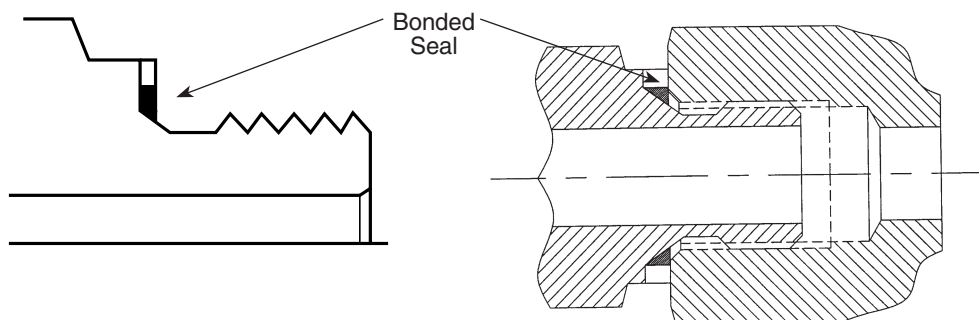

### Form B

A metal gasket (usually copper) performs the seal between the face of the body and the face of the female threaded component. For Form “B” replace “R” in part number with “BR”.

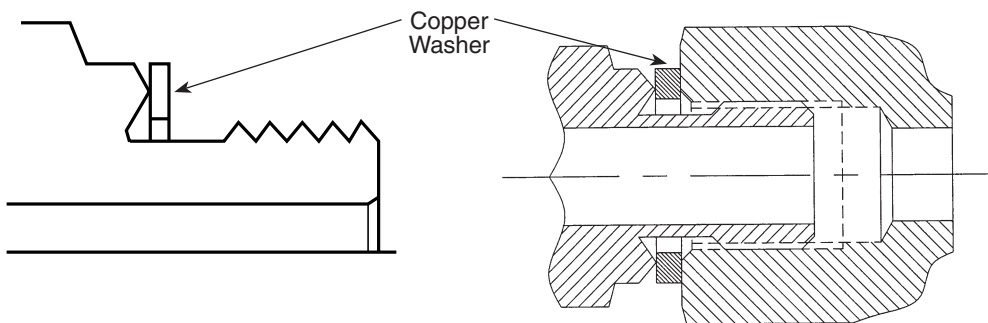

### Gauge Port BSPP (Female)

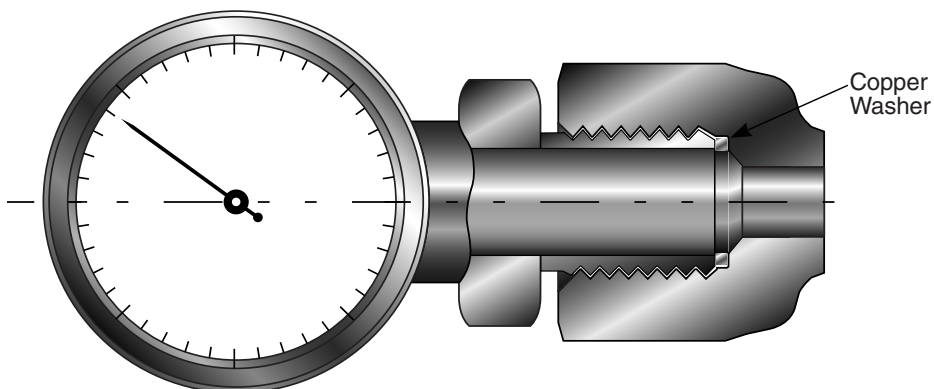

## Male Hex Nipple NPT to BSP Taper

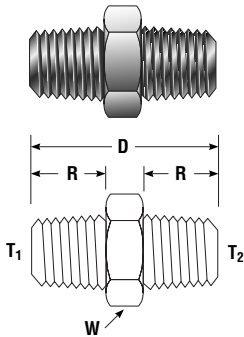

Parker Part No.	NPT Thread T <sub>1</sub>	BSPT Thread T <sub>2</sub>	W Hex	D (in.)	R (in.)	Working Pressure			
						Brass		Stainless Steel	
						PSI	Bar	PSI	Bar
2-2K MHN	1/8-27	1/8-28	7/16	1.06	.38	5600	390	9100	630
4-4K MHN	1/4-18	1/4-19	5/8	1.45	.56	4100	280	7500	520
6-6K MHN	3/8-18	3/8-19	3/4	1.45	.56	4000	280	7200	500
8-8K MHN	1/2-14	1/2-14	7/8	1.89	.75	3900	270	6600	460
12-12K MHN	3/4-14	3/4-14	1 1/8	1.97	.75	3800	260	6400	440
16-16K MHN	1-11 1/2	1-11	1 3/8	2.34	.94	2700	190	4600	320

Used to connect a female NPT and a female BSPT threaded component.

## Male Hex Nipple NPT to BSPP

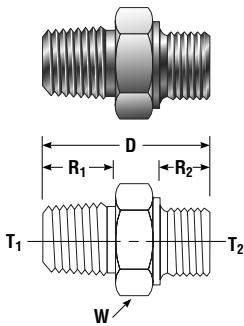

Parker Part No.	NPT Thread T <sub>1</sub>	BSPP Thread T <sub>2</sub>	W Hex	D (in.)	R <sub>1</sub> (in.)	R <sub>2</sub> (in.)	Working Pressure			
							Brass		Stainless Steel	
							PSI	Bar	PSI	Bar
2-2R MHN	1/8-27	1/8-28	9/16	1.07	.38	.28	5000	340	9100	630
4-4R MHN	1/4-18	1/4-19	3/4	1.44	.56	.44	4000	280	7500	520
6-6R MHN	3/8-18	3/8-19	7/8	1.47	.56	.44	3900	270	7200	500
8-8R MHN	1/2-14	1/2-14	1 1/16	1.78	.75	.56	3800	260	6600	460
12-12R MHN	3/4-14	3/4-14	1 5/16	1.95	.75	.63	3600	250	6400	440
16-16R MHN	1-11 1/2	1-11	1 5/8	2.26	.94	.72	2600	180	4600	320

Used to connect a female NPT and a female BSPP threaded component.

Note: Bonded seal, [page 26](#), must be used on BSPP end shown.

Please note the pressure ratings are based on taper threaded ends. The pressure rating for the BSPP ends are dependent on the type of sealing washer used.

## Female NPT to Male BSP Taper Adapter

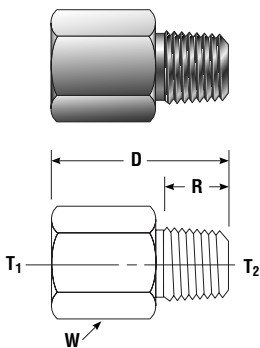

Parker Part No.	NPT Thread T <sub>1</sub>	BSPT Thread T <sub>2</sub>	W Hex	D (in.)	R (in.)	Working Pressure			
						Brass		Stainless Steel	
						PSI	Bar	PSI	Bar
2-2K RA	1/8-27	1/8-28	9/16	1.09	.38	3200	220	6100	420
4-4K RA	1/4-18	1/4-19	3/4	1.42	.56	3300	230	6200	430
6-6K RA	3/8-18	3/8-19	7/8	1.49	.56	2600	180	5000	340
8-8K RA	1/2-14	1/2-14	1 1/16	1.94	.75	2400	160	4600	320
12-12K RA	3/4-14	3/4-14	1 5/16	2.00	.75	2300	160	4300	300
16-16K RA	1-11 1/2	1-11	1 5/8	2.28	.94	2200	150	4100	280

Used to connect a male NPT and a female BSPT threaded component.

Dimensions for reference only, subject to change.

## Female NPT to Male BSPP Adapter

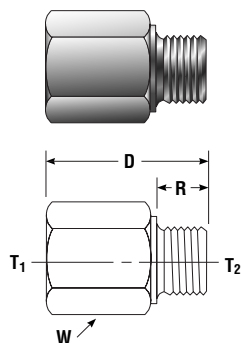

Parker Part No.	NPT Thread T <sub>1</sub>	BSPP Thread T <sub>2</sub>	W Hex	D (in.)	R (in.)	Working Pressure			
						Brass		Stainless Steel	
						PSI	Bar	PSI	Bar
2-2R RA	1/8-27	1/8-28	9/16	.99	.28	3200	220	6100	420
4-4R RA	1/4-18	1/4-19	3/4	1.31	.44	3300	230	6200	430
6-6R RA	3/8-18	3/8-19	7/8	1.41	.44	2600	180	5000	340
8-8R RA	1/2-14	1/2-14	1 1/8	1.74	.56	2400	160	4600	320
12-12R RA	3/4-14	3/4-14	1 5/16	2.00	.63	2300	160	4300	300
16-16R RA	1-11 1/2	1-11	1 5/8	2.10	.72	2200	150	4100	280

Used to connect a male NPT and a female BSPP threaded component.  
Note: Bonded Seal, [page 26](#), must be used with BSPP end shown.

## Female BSP Taper to Male NPT Adapter

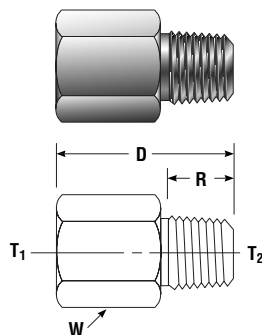

Parker Part No.	BSPT Thread T <sub>1</sub>	NPT Thread T <sub>2</sub>	W Hex	D (in.)	R (in.)	Working Pressure			
						Brass		Stainless Steel	
						PSI	Bar	PSI	Bar
2K-2 RA	1/8-28	1/8-27	9/16	1.09	.38	3200	220	6100	420
4K-4 RA	1/4-19	1/4-18	3/4	1.42	.56	3300	230	6200	430
6K-6 RA	3/8-19	3/8-18	7/8	1.49	.56	2600	180	5000	340
8K-8 RA	1/2-14	1/2-14	1 1/8	1.94	.75	2400	160	4600	320
12K-12 RA	3/4-14	3/4-14	1 5/16	2.00	.75	2300	160	4300	300
16K-16 RA	1-11	1-11 1/2	1 5/8	2.28	.94	2200	150	4100	280

Used to connect a male BSPT and a female NPT threaded component.

## Female BSPP to Male NPT Adapter

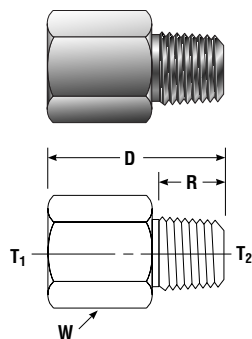

Parker Part No.	BSPP Thread T <sub>1</sub>	NPT Thread T <sub>2</sub>	W Hex	D (in.)	R (in.)	Working Pressure			
						Brass		Stainless Steel	
						PSI	Bar	PSI	Bar
2R-2 RA	1/8-28	1/8-27	9/16	1.09	.38	3200	220	6100	420
4R-4 RA	1/4-19	1/4-18	3/4	1.50	.56	3300	230	6200	430
6R-6 RA	3/8-19	3/8-18	7/8	1.49	.56	2600	180	5000	340
8R-8 RA	1/2-14	1/2-14	1 1/8	1.88	.75	2400	160	4600	320
12R-12 RA	3/4-14	3/4-14	1 5/16	2.00	.75	2300	160	4300	300
16R-16 RA	1-11	1-11 1/2	1 5/8	2.28	.94	2200	150	4100	280

Used to connect a male BSPP and a female NPT threaded component.

## BSP Taper Male Hex Pipe Plug

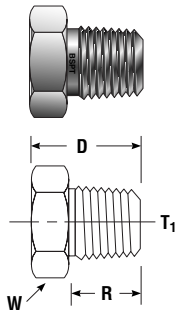

Parker Part No.	BSPT Thread T <sub>1</sub>	W Hex	D (in.)	R (in.)	Working Pressure			
					Brass		Stainless Steel	
					PSI	Bar	PSI	Bar
2K PH	1/8-28	7/16	.59	.38	3200	220	6100	420
4K PH	1/4-19	5/8	.81	.56	3300	230	6200	430
6K PH	3/8-19	3/4	.81	.56	2600	180	5000	340
8K PH	1/2-14	7/8	1.06	.75	2400	160	3600	320
12K PH	3/4-14	1 1/8	1.13	.75	2300	160	4300	300
16K PH	1-11	1 3/8	1.31	.94	2200	150	4100	280

## BSPP Parallel Male Hex Pipe Plug

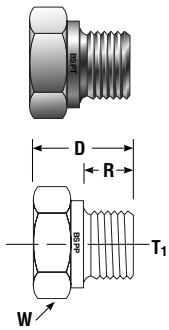

Parker Part No.	BSPP Thread T <sub>1</sub>	W Hex	D (in.)	R (in.)	Working Pressure			
					Brass		Stainless Steel	
					PSI	Bar	PSI	Bar
2R PH	1/8-28	9/16	.55	.28	5000	340	9100	630
4R PH	1/4-19	3/4	.78	.44	4000	280	7500	520
6R PH	3/8-19	7/8	.78	.44	3900	270	7200	500
8R PH	1/2-14	1-1/16	.99	.56	3800	260	6600	460
12R PH	3/4-14	1-5/16	1.13	.63	3600	250	6400	440
16R PH	1-11	1-5/8	1.21	.72	2600	180	4600	320

Note: Bonded seal [page 26](#) must be used on BSPP end shown. Please note the pressure ratings are based on taper threaded ends. The pressure rating for the BSPP ends are dependent on the type of sealing washer used.

Dimensions for reference only, subject to change.

## BSP Taper Male Connector

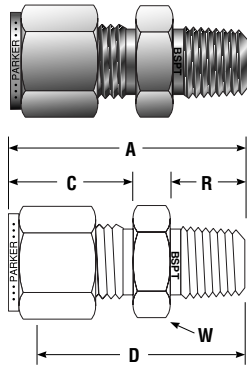

Tube O.D. (in.)	BSP Thread	Parker CPI™ Part No.	Parker A-LOK® Part No.	A (in.)	C (in.)	D (in.)	R (in.)	W Hex
1/8	1/8-28	2-2K FBZ	2MSC2K	1.20	.60	.94	.38	7/16
1/8	1/4-19	2-4K FBZ	2MSC4K	1.40	.60	1.14	.56	9/16
1/4	1/8-28	4-2K FBZ	4MSC2K	1.30	.70	1.00	.38	1/2
1/4	1/4-19	4-4K FBZ	4MSC4K	1.50	.70	1.20	.56	9/16
1/4	3/8-19	4-6K FBZ	4MSC6K	1.52	.70	1.22	.56	11/16
1/4	1/2-14	4-8K FBZ	4MSC8K	1.76	.70	1.44	.75	7/8
5/16	1/8-28	5-2K FBZ	5MSC2K	1.34	.73	1.05	.38	9/16
5/16	1/4-19	5-4K FBZ	5MSC4K	1.53	.73	1.23	.56	9/16
3/8	1/8-28	6-2K FBZ	6MSC2K	1.39	.76	1.09	.38	5/8
3/8	1/4-19	6-4K FBZ	6MSC4K	1.59	.76	1.28	.56	5/8
3/8	3/8-19	6-6K FBZ	6MSC6K	1.59	.76	1.28	.56	11/16
3/8	1/2-14	6-8K FBZ	6MSC8K	1.82	.76	1.53	.75	7/8
1/2	1/4-19	8-4K FBZ	8MSC4K	1.75	.87	1.31	.56	13/16
1/2	3/8-19	8-6K FBZ	8MSC6K	1.75	.87	1.31	.56	13/16
1/2	1/2-14	8-8K FBZ	8MSC8K	1.93	.87	1.53	.75	7/8

Connects fractional tube to female ISO taper thread.

## BSPP Male Connector

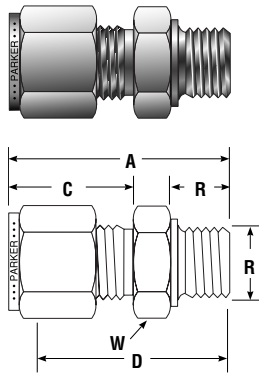

Tube O.D. (in.)	BSP Thread	Parker CPI™ Part No.	Parker A-LOK® Part No.	A (in.)	C (in.)	D (in.)	R (in.)	W Hex
1/8	1/8-28	2-2R FBZ	2MSC2R	1.18	.60	0.92	.28	9/16
1/8	1/4-19	2-4R FBZ	2MSC4R	1.38	.60	1.13	.44	3/4
1/8	3/8-19	2-6R FBZ	2MSC6R	1.43	.60	1.17	.44	7/8
1/4	1/8-28	4-2R FBZ	4MSC2R	1.28	.70	0.98	.28	9/16
1/4	1/4-19	4-4R FBZ	4MSC4R	1.49	.70	1.19	.44	3/4
1/4	3/8-19	4-6R FBZ	4MSC6R	1.55	.70	1.25	.44	7/8
1/4	1/2-14	4-8R FBZ	4MSC8R	1.77	.70	1.47	.56	1 1/16
3/8	1/8-28	6-2R FBZ	6MSC2R	1.37	.76	1.06	.28	5/8
3/8	1/4-19	6-4R FBZ	6MSC4R	1.57	.76	1.25	.44	3/4
3/8	3/8-19	6-6R FBZ	6MSC6R	1.59	.76	1.30	.44	7/8
3/8	1/2-14	6-8R FBZ	6MSC8R	1.84	.76	1.53	.56	1 1/16
1/2	1/4-19	8-4R FBZ	8MSC4R	1.71	.87	1.28	.44	13/16
1/2	3/8-19	8-6R FBZ	8MSC6R	1.74	.87	1.30	.44	7/8
1/2	1/2-14	8-8R FBZ	8MSC8R	1.96	.87	1.53	.56	1 1/16
3/4	1/2-14	12-8R FBZ	12MSC8R	1.93	.87	1.53	.56	1 1/16
3/4	3/4-19	12-12R FBZ	12MSC12R	2.10	.87	1.69	.63	1 3/8
1	1/2-14	16-8R FBZ	16MSC8R	2.21	1.05	1.72	.56	1 3/8
1	1-11	16-16R FBZ	16MSC16R	2.37	1.05	1.88	.72	1 5/8

Connects fractional tube to female ISO parallel thread.  
Note: Bonded Seal, [page 26](#), must be used with BSPP end shown.

Dimensions for reference only, subject to change.

## BSP Taper Female Connector

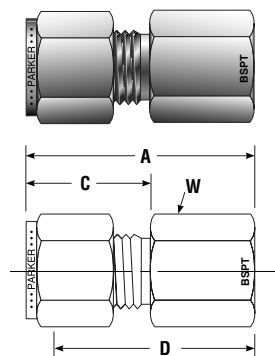

Tube O.D. (in.)	BSPT Thread	Parker CPI™ Part No.	Parker A-LOK® Part No.	A (in.)	C (in.)	D (in.)	W Hex
1/4	1/8-28	4-2K GBZ	4FSC2K	1.23	.70	.94	9/16
1/4	1/4-19	4-4K GBZ	4FSC4K	1.42	.70	1.13	3/4
1/4	3/8-19	4-6K GBZ	4FSC6K	1.48	.70	1.19	7/8
1/4	1/2-14	4-8K GBZ	4FSC8K	1.67	.70	1.38	1 1/16
3/8	1/4-19	6-4K GBZ	6FSC4K	1.48	.76	1.19	3/4
3/8	3/8-19	6-6K GBZ	6FSC6K	1.54	.76	1.25	7/8
3/8	1/2-14	6-8K GBZ	6FSC8K	1.73	.76	1.44	1 1/16
1/2	1/4-19	8-4K GBZ	8FSC4K	1.59	.87	1.19	13/16
1/2	3/8-19	8-6K GBZ	8FSC6K	1.65	.87	1.25	7/8
1/2	1/2-14	8-8K GBZ	8FSC8K	1.84	.87	1.44	1 1/16

Connects fractional tube to male ISO taper thread.

## BSPP Female Gauge Connector

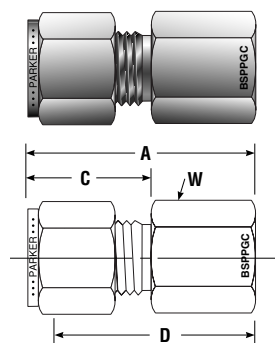

Tube O.D. (in.)	BSPP Thread	Parker CPI™ Part No.	Parker A-LOK® Part No.	A (in.)	C (in.)	D (in.)	W Hex
1/4	1/4-19	4-4GC GBZ	4FSC4GC	1.48	.70	1.19	3/4
1/4	3/8-19	4-6GC GBZ	4FSC6GC	1.48	.70	1.19	7/8
1/4	1/2-14	4-8GC GBZ	4FSC8GC	1.72	.70	1.42	1 1/16
5/16	1/4-19	5-4GC GBZ	5FSC4GC	1.51	.73	1.22	3/4
5/16	1/2-14	5-8GC GBZ	5FSC8GC	1.61	.73	1.32	1 1/16
3/8	1/4-19	6-4GC GBZ	6FSC4GC	1.54	.76	1.25	3/4
3/8	3/8-19	6-6GC GBZ	6FSC6GC	1.53	.76	1.23	7/8
3/8	1/2-14	6-8GC GBZ	6FSC8GC	1.65	.76	1.36	1 1/16
1/2	3/8-19	8-6GC GBZ	8FSC6GC	1.75	.87	1.35	7/8
1/2	1/2-14	8-8GC GBZ	8FSC8GC	1.90	.87	1.50	1 1/16

Connects fractional tube to male ISO parallel (gauge).

Note: Copper Washer, [page 26](#), for female thread sealing, must be used on BSPP female end shown.

## BSP Taper Male Elbow

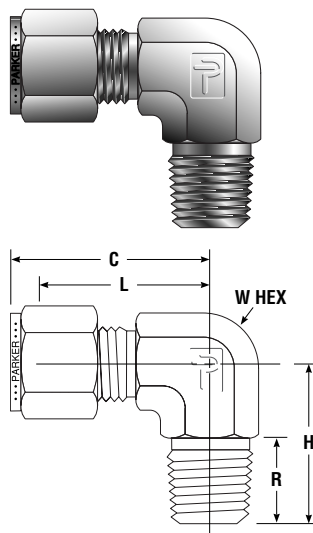

Tube O.D. (in.)	BSPT Thread	Parker CPI™ Part No.	Parker A-LOK® Part No.	C (in.)	H (in.)	L (in.)	R (in.)	W Hex
1/4	1/8-28	4-2K CBZ	4MSEL2K	1.06	.74	.77	.38	1/2
1/4	1/4-19	4-4K CBZ	4MSEL4K	1.08	1.00	.78	.56	9/16
1/4	3/8-19	4-6K CBZ	4MSEL6K	1.17	1.13	.88	.56	3/4
1/4	1/2-14	4-8K CBZ	4MSEL8K	1.26	1.31	.97	.75	7/8
5/16	1/4-19	5-4K CBZ	5MSEL4K	1.11	1.00	.81	.56	5/8
3/8	1/8-28	6-2K CBZ	6MSEL2K	1.20	.82	.91	.38	5/8
3/8	1/4-19	6-4K CBZ	6MSEL4K	1.20	1.01	.91	.56	5/8
3/8	3/8-19	6-6K CBZ	6MSEL6K	1.26	1.13	.97	.56	3/4
1/2	3/8-19	8-6K CBZ	8MSEL6K	1.42	1.15	1.02	.56	13/16
1/2	1/2-14	8-8K CBZ	8MSEL8K	1.42	1.30	1.02	.75	7/8

Connects fractional tube to female ISO taper thread.

Dimensions for reference only, subject to change.



## BSPP Male Elbow (Positionable)

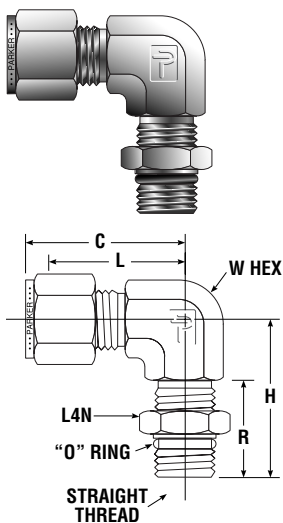

Tube O.D. (in.)	BSPP Thread	Parker CPI™ Part No.	Parker A-LOK® Part No.	C (in.)	H (in.)	L (in.)	R (in.)	W Hex
1/4	1/8-28	4-2R CBZ	4MSEL2R	1.06	1.04	.77	.63	9/16
1/4	1/4-19	4-4R CBZ	4MSEL4R	1.14	1.27	.85	.79	9/16
3/8	1/4-19	6-4R CBZ	6MSEL4R	1.14	1.27	.85	.79	9/16
3/8	3/8-19	6-6R CBZ	6MSEL6R	1.50	1.46	1.02	.79	3/4
1/2	1/4-19	8-4R CBZ	8MSEL4R	1.50	1.38	1.10	.79	7/8
1/2	3/8-19	8-6R CBZ	8MSEL6R	1.50	1.46	1.10	.79	7/8
1/2	1/2-14	8-8R CBZ	8MSEL8R	1.50	1.71	1.10	1.03	7/8
5/8	1/2-14	10-8R CBZ	10MSEL8R	1.50	1.81	1.10	1.03	1 1/16
3/4	1/2-14	12-8R CBZ	12MSEL8R	1.57	1.81	1.17	1.03	1 1/16
3/4	3/4-14	12-12R CBZ	12MSEL12R	1.57	1.92	1.17	1.03	1 1/16
1	3/4-14	16-12R CBZ	16MSEL12R	1.94	2.11	1.45	1.03	1 5/16
1	1-11	16-16R CBZ	16MSEL16R	1.94	2.11	1.45	1.20	1 5/16

Connects fractional tube to female ISO parallel thread.

## BSPP Male Run Tee (Positionable)

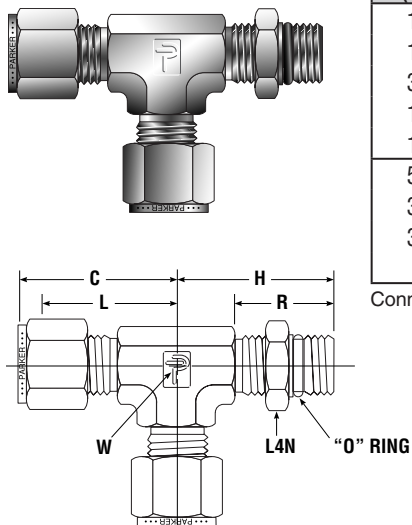

Tube O.D. (in.)	BSPP Thread	Parker CPI™ Part No.	Parker A-LOK® Part No.	C (in.)	H (in.)	L (in.)	R (in.)	W Hex
1/4	1/8-28	4-2R-4 RBZ	4MRT2R	1.06	1.04	.77	.63	9/16
1/4	1/4-19	4-4R-4 RBZ	4MRT4R	1.14	1.27	.85	.79	9/16
3/8	1/4-19	6-4R-6 RBZ	6MRT6R	1.20	1.27	.91	.79	9/16
1/2	3/8-19	8-6R-8 RBZ	8MRT8R	1.50	1.46	1.10	.79	7/8
1/2	1/2-14	8-8R-8 RBZ	8MRT8R	1.50	1.71	1.10	1.03	7/8
5/8	1/2-14	10-8R-10 RBZ	10MRT8R	1.50	1.81	1.10	1.03	1 1/16
3/4	1/2-14	12-8R-12 RBZ	12MRT8R	1.57	1.81	1.17	1.03	1 1/16
3/4	3/4-14	12-12R-12 RBZ	12MRT12R	1.57	1.92	1.17	1.03	1 1/16
1	1-11	16-16R-16 RBZ	16MRT16R	1.94	2.11	1.45	1.20	1 5/16

Connects fractional tube to female ISO parallel thread.

Dimensions for reference only, subject to change.

## BSPP Male Branch Tee (Positionable)

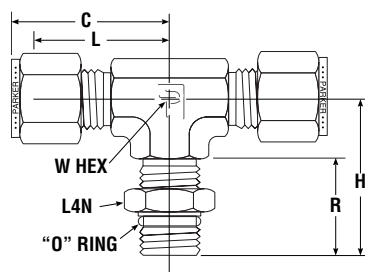
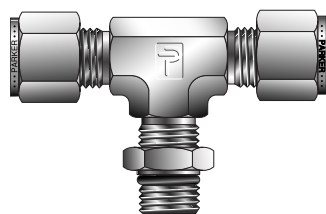

Tube O.D. (in.)	BSPP Thread	Parker CPI™ Part No.	Parker A-LOK® Part No.	C (in.)	H (in.)	L (in.)	R (in.)	W Hex
1/4	1/8-28	4-4-2R SBZ	4MBT2R	1.06	1.04	.77	.63	9/16
1/4	1/4-19	4-4-4R SBZ	4MBT4R	1.14	1.27	.85	.79	9/16
3/8	1/4-19	6-6-4R SBZ	6MBT4R	1.14	1.27	.85	.79	9/16
1/2	3/8-19	8-8-6R SBZ	8MBT6R	1.50	1.46	1.10	.79	7/8
1/2	1/2-14	8-8-8R SBZ	8MBT8R	1.50	1.71	1.10	1.03	7/8
5/8	1/2-14	10-10-8R SBZ	10MBT8R	1.50	1.81	1.10	1.03	1 1/16
3/4	1/2-14	12-12-8R SBZ	12MBT8R	1.57	1.81	1.17	1.03	1 1/16
3/4	3/4-14	12-12-12R SBZ	12MBT12R	1.57	1.92	1.17	1.03	1 1/16
1	1-11	16-16-16R SBZ	16MBT16R	1.94	2.11	1.45	1.20	1 5/16

Connects fractional tube to female ISO parallel thread.

## BSP Taper Male Adapter

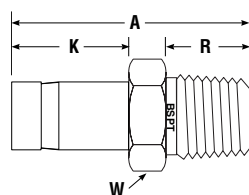
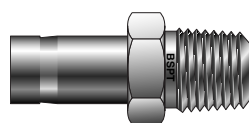

Tube O.D. (in.)	BSPT Thread	Parker CPI™ Part No.	Parker A-LOK® Part No.	CPI™		A-LOK®		R (in.)	W Hex	Min. Bore (in.)
				A (in.)	K (in.)	A (in.)	K (in.)			
1/8	1/8-28	2-2K T2HF	2MA2K	1.16	0.54	1.16	.54	.38	7/16	.078
1/8	1/4-19	2-4K T2HF	2MA4K	1.39	0.54	1.39	.54	.56	9/16	.281
1/4	1/8-28	4-2K T2HF	4MA2K	1.27	0.64	1.25	.63	.38	7/16	.156
1/4	1/4-19	4-4K T2HF	4MA4K	1.49	0.64	1.46	.63	.56	9/16	.078
5/16	1/8-28	5-2K T2HF	5MA2K	1.32	0.68	1.28	.66	.38	7/16	.219
5/16	1/4-19	5-4K T2HF	5MA4K	1.53	0.68	1.49	.66	.56	9/16	.219
3/8	1/4-19	6-4K T2HF	6MA4K	1.57	0.72	1.53	.69	.56	9/16	.281
3/8	3/8-19	6-6K T2HF	6MA6K	1.61	0.72	1.56	.69	.56	11/16	.281
3/8	1/2-14	6-8K T2HF	6MA8K	1.82	0.72	1.78	.69	.75	7/8	.281
1/2	1/4-19	8-4K T2HF	8MA4K	1.84	0.98	1.75	.91	.75	9/16	.281
1/2	3/8-19	8-6K T2HF	8MA6K	1.87	0.98	1.78	.91	.56	11/16	.375
1/2	1/2-14	8-8K T2HF	8MA8K	2.09	0.98	2.00	.91	.75	7/8	.375
5/8	3/8-19	10-6K T2HF	10MA6K	1.91	1.03	1.84	.97	.56	11/16	.469
5/8	1/2-14	10-8K T2HF	10MA8K	2.14	1.03	2.06	.97	.75	7/8	.469
3/4	3/4-14	12-12K T2HF	12MA12K	2.14	1.03	2.06	.97	.75	1 1/16	.594
1	1-11	16-16K T2HF	16MA16K	2.68	1.30	2.60	1.22	.94	1 3/8	.813

Connects fractional tube to female ISO taper thread.  
Generic, annealed tube stub for effective ferrule sealing.

Dimensions for reference only, subject to change.

## BSPP Male Adapter

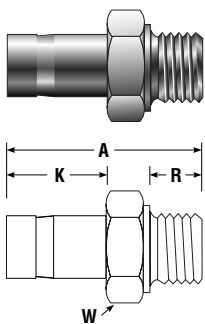

Tube O.D. (in.)	BSPP Thread	Parker CPI™ Part No.	Parker A-LOK® Part No.	CPI™		A-LOK®		R (in.)	W Hex	Min. Bore (in.)h
				A (in.)	K (in.)	A (in.)	K (in.)			
1/8	1/8-28	2-2R T2HF	2MA2R	1.16	.54	1.16	.54	.28	9/16	.078
1/8	1/4-19	2-4R T2HF	2MA4R	1.37	.54	1.37	.54	.44	3/4	.078
1/4	1/8-28	4-2R T2HF	4MA2R	1.26	.64	1.31	.63	.28	9/16	.156
1/4	1/4-19	4-4R T2HF	4MA4R	1.48	.64	1.50	.63	.44	3/4	.156
3/8	1/4-19	6-4R T2HF	6MA4R	1.56	.72	1.57	.69	.44	3/4	.281
3/8	3/8-19	6-6R T2HF	6MA6R	1.59	.72	1.60	.69	.44	7/8	.281
1/2	1/4-19	8-4R T2HF	8MA4R	1.81	.98	1.79	.91	.44	3/4	.375
1/2	3/8-19	8-6R T2HF	8MA6R	1.85	.98	1.82	.91	.44	7/8	.375
1/2	1/2-14	8-8R T2HF	8MA8R	2.10	.98	1.94	.91	.44	1-1/8	.375
3/4	3/4-14	12-12R T2HF	12MA12R	2.22	1.03	2.16	.97	.63	1-3/8	.594
1	1-11	16-16R T2HF	16MA16R	2.67	1.30	2.54	1.22	.72	1-3/4	.813

Connects fractional tube end to female ISO parallel thread.  
 Note: Bonded Seal, page 26 must be used on BSPP end shown.  
 Generic, annealed tube stub for effective sealing.

## BSP Taper Female Adapter

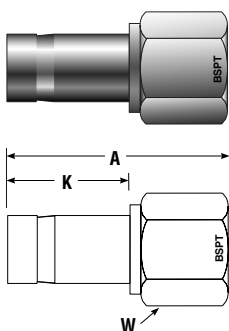

Tube O.D. (in.)	BSPT Thread	Parker CPI™ Part No.	Parker A-LOK® Part No.	CPI™		A-LOK®		W Hex	Min. Bore (in.)
				A (in.)	K (in.)	A (in.)	K (in.)		
1/4	1/8-28	4-2K T2HG	4FA2K	1.31	.64	1.30	.63	9/16	.156
1/4	1/4-19	4-4K T2HG	4FA4K	1.48	.64	1.45	.63	3/4	.156
3/8	1/4-19	6-4K T2HG	6FA4K	1.56	.72	1.50	.69	3/4	.281
3/8	3/8-19	6-6K T2HG	6FA6K	1.63	.72	1.59	.69	7/8	.281
1/2	1/4-19	8-4K T2HG	8FA4K	1.83	.98	1.71	.91	3/4	.375
1/2	3/8-19	8-6K T2HG	8FA6K	1.89	.98	1.80	.91	7/8	.375
1/2	1/2-14	8-8K T2HG	8FA8K	2.14	.98	2.05	.91	1-1/16	.375

Connects fractional tube end to male ISO taper thread.  
 Note: Tube stub is pre-grooved as standard. Generic (non-grooved) can be ordered through Quick Response.

## BSPP Female Adapter

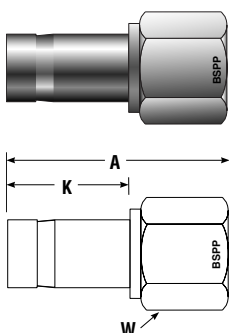

Tube O.D. (in.)	BSPP Thread	Parker CPI™ Part No.	Parker A-LOK® Part No.	CPI™		A-LOK®		W Hex	Min. Bore (in.)
				A (in.)	K (in.)	A (in.)	K (in.)		
1/8	1/8-28	2-2R T2HG	2FA2R	1.21	.54	1.21	.54	9/16	.078
1/4	1/8-28	4-2R T2HG	4FA2R	1.31	.64	1.25	.63	9/16	.156
1/4	1/4-19	4-4R T2HG	4FA4R	1.48	.64	1.50	.63	3/4	.156
3/8	1/4-19	6-4R T2HG	6FA4R	1.56	.72	1.55	.69	3/4	.281
3/8	3/8-19	6-6R T2HG	6FA6R	1.63	.72	1.57	.69	7/8	.281
1/2	3/8-19	8-6R T2HG	8FA6R	1.89	.98	1.78	.91	7/8	.375
1/2	1/2-14	8-8R T2HG	8FA8R	2.14	.98	1.95	.91	1-1/16	.375

Connects fractional tube end to male ISO parallel thread.  
 Note: Tube stub is pre-grooved as standard. Generic (non-grooved) can be ordered through Quick Response.

Dimensions for reference only, subject to change.

## BSPP Female Gauge Adapter

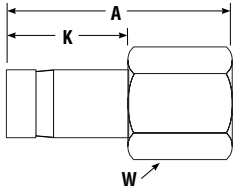
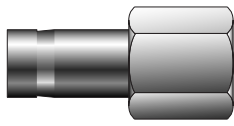

Tube O.D. (in.)	BSPP Thread	Parker CPI™ Part No.	Parker A-LOK® Part No.	CPI™		A-LOK®		W Hex	Min. Bore (in.)
				A (in.)	K (in.)	A (in.)	K (in.)		
1/4	1/4-19	4-4GC T2HG	4FA4GC	1.48	.64	1.34	.63	3/4	.156
3/8	3/8-19	6-6GC T2HG	6FA6GC	1.63	.72	1.55	.69	7/8	.281
1/2	1/2-14	8-8GC T2HG	8FA8GC	2.14	.98	1.92	.91	1 1/16	.375

Connects fractional tube end to male ISO parallel thread (gauge).

Note: Copper Washer, shown below, for female thread sealing, must be used on BSPP female end shown.

Note: Tube stub is pre-grooved as standard. Generic (non-grooved) can be ordered through Quick Response.

## Sealing Washers

### Bonded Seals

Consists of an outer stainless steel ring with a bonded Viton® inner ring used to seal a male ISO parallel thread.

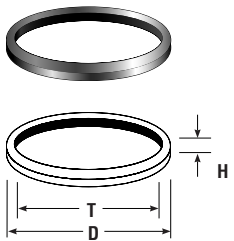

Part No.	T BSPP Thread	D (in.)	H (in.)
M30201-SS	1/8	.63	.08
M30202-SS	1/4	.81	.08
M30203-SS	3/8	.94	.08
M30204-SS	1/2	1.12	.10
M30206-SS	3/4	1.38	.10
M30208-SS	1	1.69	.10

Pressure Ratings For Sealing Washers		
Thread Size	PSI	Bar
1/8	5300	370
1/4	5500	380
3/8	4400	300
1/2	4000	280
3/4	3700	260
1	2800	190

These seals are also available in steel with a Nitrile inner ring. Simply replace Suffix SS with S.

### Copper Washers

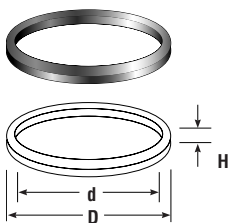

For BSPP male thread sealing

Part No.	Thread	D* (in.)	d (in.)	H (in.)
M28329	1/8	.71	.39	.09
M28330	1/4	.87	.55	.09
M28331	3/8	.94	.67	.09
M28332	1/2	1.18	.87	.10
M28334	3/4	1.38	1.06	.09
M28336	1	1.65	1.34	.09

For BSPP female thread sealing

Part No.	Thread	D (in.)	d (in.)	H (in.)
M25179	1/8	0.322	0.188	0.062
M25180	1/4	0.436	0.250	0.062
M25181	3/8	0.574	0.375	0.062
M25182	1/2	0.719	0.500	0.062
M25184	3/4	0.935	0.719	0.062
M25186	1	1.178	0.969	0.093

Used to provide a seal with male or female parallel ISO threads.

\* Gasket fits ISO 1179-1 type G/H port.

Please note the pressure ratings are based on taper threaded ends. The pressure rating for the BSPP ends are dependent on the type of sealing washer used.

Dimensions for reference only, subject to change.

## NPT Thread

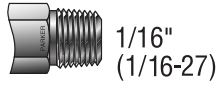

1/16"  
(1/16-27)

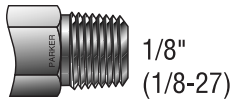

1/8"  
(1/8-27)

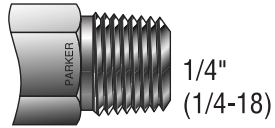

1/4"  
(1/4-18)

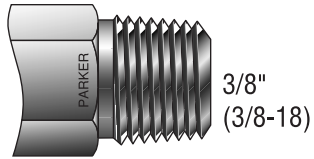

3/8"  
(3/8-18)

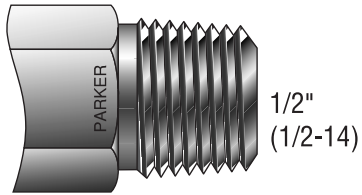

1/2"  
(1/2-14)

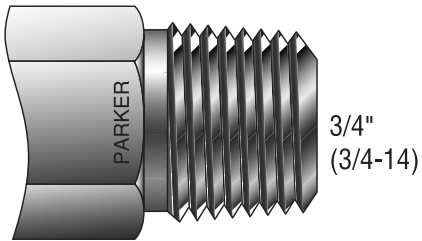

3/4"  
(3/4-14)

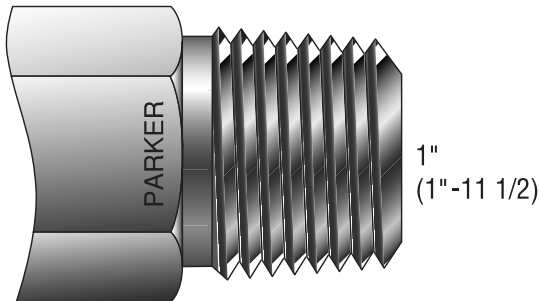

1"  
(1"-11 1/2)

### American Standard Pipe Thread (NPT)

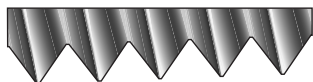

- 60° thread angle • Pitch measured in inches
- Truncation of root and crest are flat
- Taper angle 1°47'

## Straight Thread

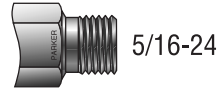

5/16-24

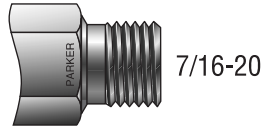

7/16-20

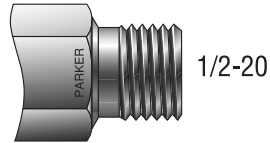

1/2-20

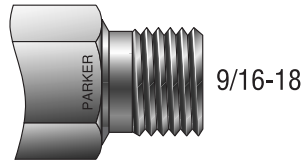

9/16-18

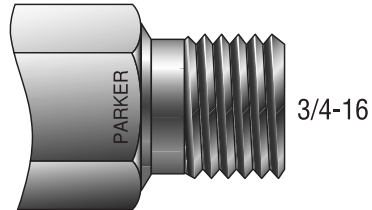

3/4-16

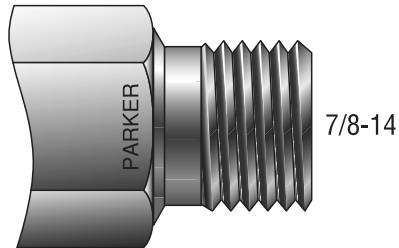

7/8-14

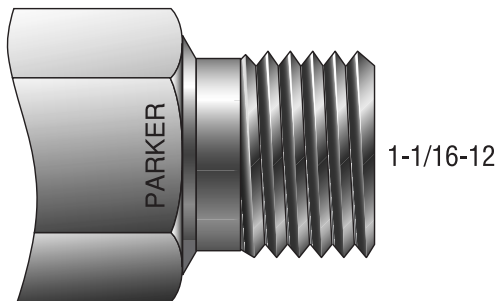

1-1/16-12

### American Standard Unified Thread (Straight)

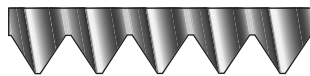

- 60° thread angle • Pitch measured in inches
- Truncation of root and crest are flat
- Diameter measured in inches

## Tubing O.D. Size

○ 1/16"

○ 1/8"

○ 3/16"

○ 1/4"

○ 5/16"

○ 3/8"

○ 1/2"

○ 5/8"

○ 3/4"

○ 7/8"

○ 1"

## NPT Thread

## Tubing O.D. Size

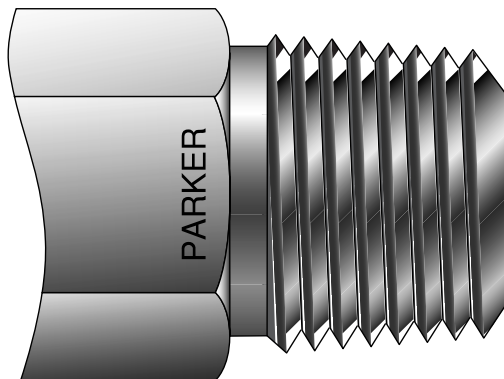

1-1/4"  
(1-1/4" - 11-1/2")

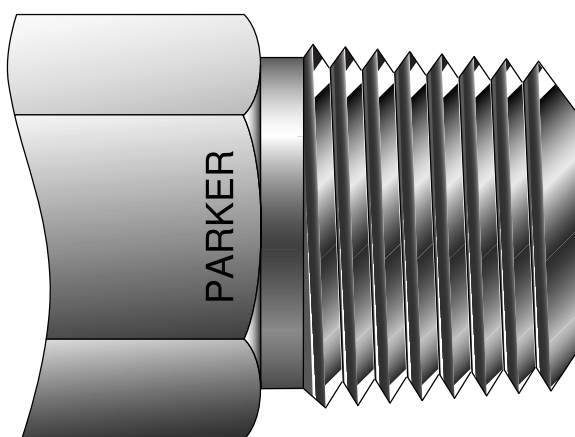
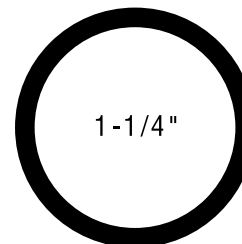

1-1/2"  
(1-1/2" - 11-1/2")

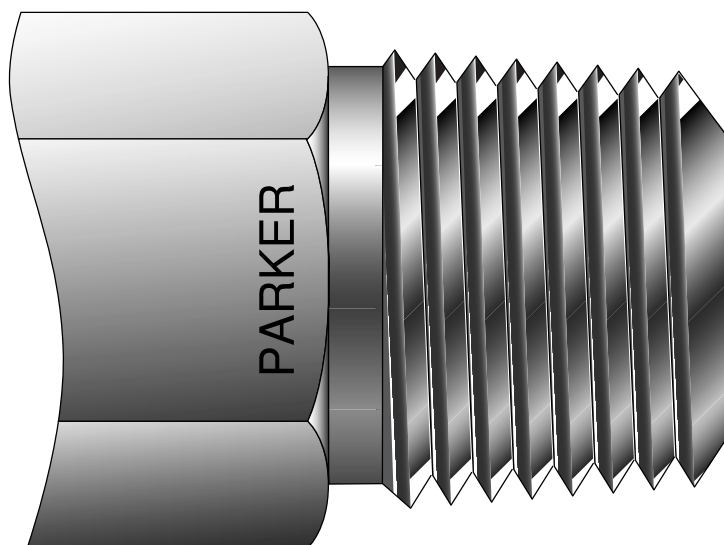
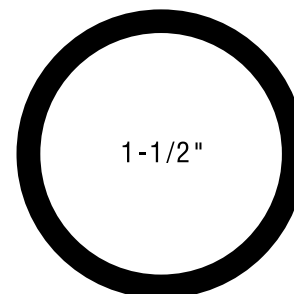

2"  
(2" - 11-1/2")

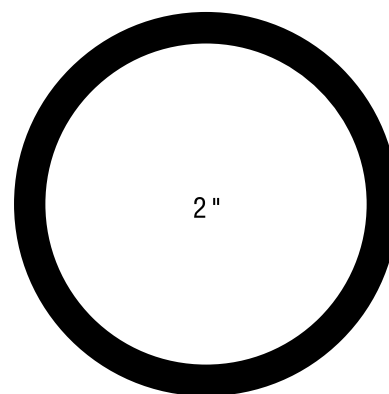

## BSPT Tapered Thread

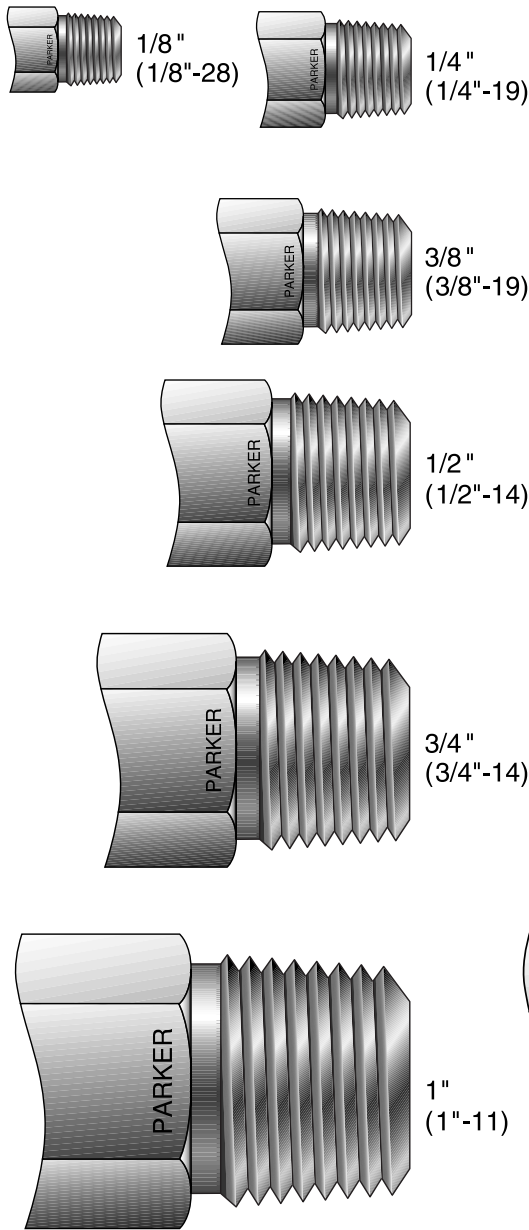

## BSPB Parallel Thread

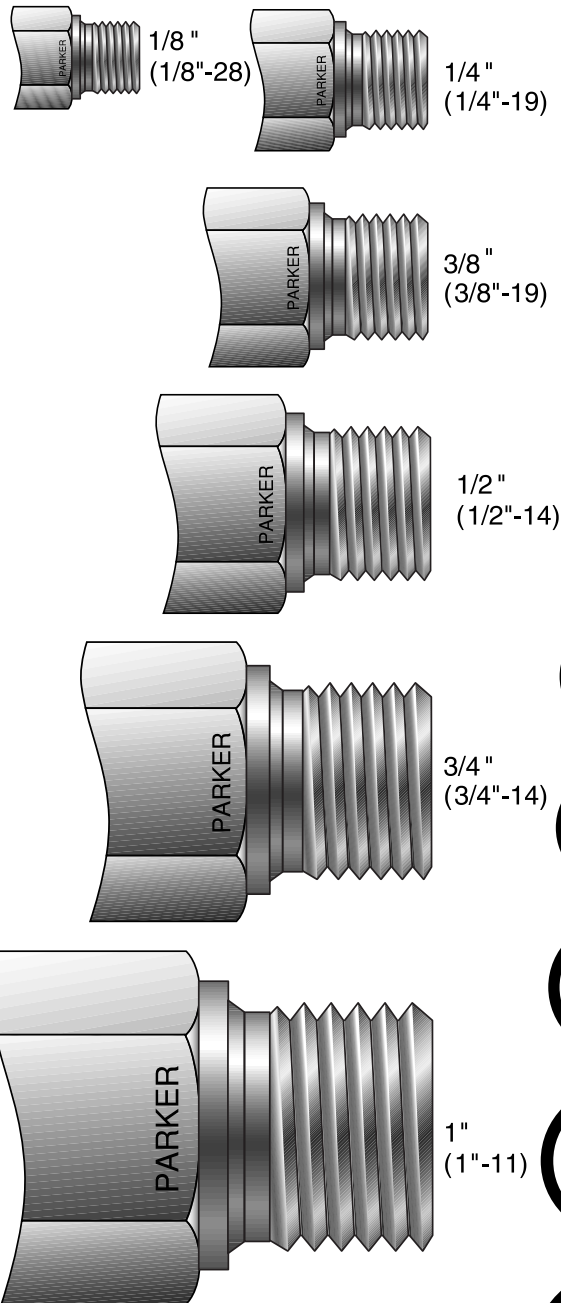

## Tubing O.D. Size

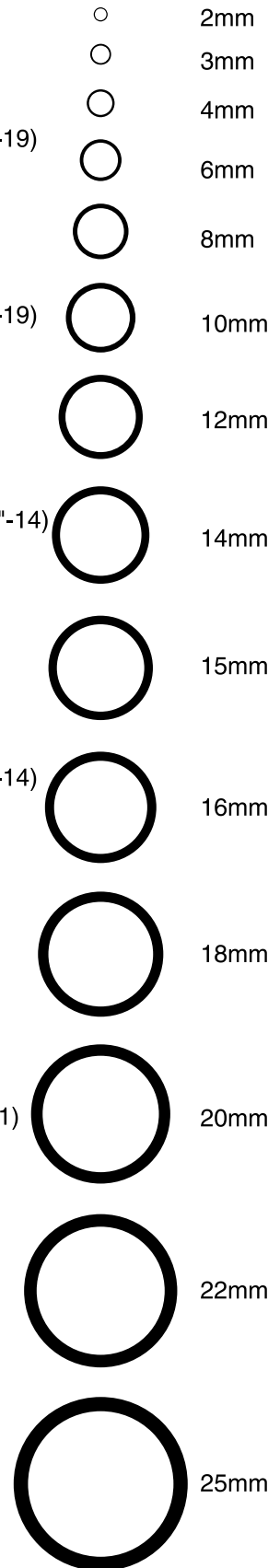

## International Organization for Standards

### (ISO 7/1)

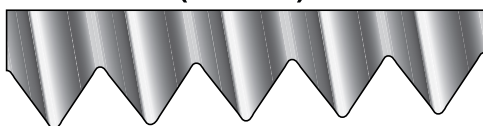

- 55° thread angle • Pitch measured in inches
- Truncation of root and crest are round
- Taper angle 1°47'

### (ISO 228/1)

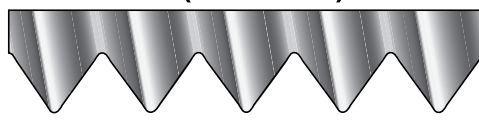

- 55° thread angle • Pitch measured in inches
- Truncation of root and crest are round
- Diameter measured in inches

## Pipe Data and Dimensions

Pipe Size (Inches)	Schedule #	Iron Pipe Size	Dimensions		
			Outside Diameter (Inches)	Inside Diameter (Inches)	Wall Thickness (Inches)
1/8	—	—	0.405	0.307	0.049
	40	STD		0.269	0.068
	80	XS		0.215	0.095
1/4	—	—	0.540	0.410	0.065
	40	STD		0.364	0.088
	80	XS		0.302	0.119
3/8	—	—	0.675	0.545	0.065
	40	STD		0.493	0.091
	80	XS		0.423	0.126
1/2	—	—	0.840	0.710	0.065
	—	—		0.674	0.083
	40	STD		0.622	0.109
	80	XS		0.546	0.147
	160	—		0.466	0.187
—	XXS	0.252	0.294		
3/4	—	—	1.050	0.920	0.065
	—	—		0.884	0.083
	40	STD		0.824	0.113
	80	XS		0.742	0.154
	160	—		0.612	0.219
—	XXS	0.434	0.308		
1	—	—	1.315	1.185	0.065
	—	—		1.097	0.109
	40	STD		1.049	0.133
	80	XS		0.957	0.179
	160	—		0.815	0.25
—	XXS	0.599	0.358		
1-1/4	—	—	1.660	1.530	0.065
	—	—		1.442	0.109
	40	STD		1.38	0.140
	80	XS		1.278	0.191
	160	—		1.160	0.250
—	XXS	0.896	0.382		
1-1/2	—	—	1.900	1.770	0.065
	—	—		1.682	0.109
	40	STD		1.610	0.145
	80	XS		1.500	0.200
	160	—		1.338	0.281
—	XXS	1.100	0.400		
2	—	—	2.375	2.245	0.065
	—	—		2.157	0.109
	40	STD		2.067	0.154
	80	XS		1.939	0.218
	160	—		1.687	0.344
—	XXS	1.503	0.436		



## Heat Code Traceability

Parker Hannifin's Instrumentation Connectors Division offers Heat Code Traceability (HCT) on CPI™, A-LOK®, Instrumentation Pipe, and Weld-Lok fittings.

HCT refers to the fact that a specific part can be traced back to the original mill heat of metal from which it was made. Beginning with the original melt, a package of documents is created which completely describes the metal in physical and chemical terms. The end result is that a number, which is permanently stamped to the part, refers back to the document package.

The HCT number is stamped on the material (bar stock or forging) prior to manufacturing. The concept is useful because it provides a method for complete material accountability for the manufacturer and end customer.

HCT offers these advantages:

- Raw materials for manufacture must meet code requirements. This can be verified through documentation so that the customer is certain that what is ordered is received.
- HCT provides a record of chemical analysis with the raw material. Thus, in areas requiring welding, the correct welding technique is applied.

- HCT relieves the user of Parker instrumentation tube fittings of any doubts. It acts as an assurance for today and for tomorrow.

The material used in Parker Hannifin instrumentation fitting components is 316 or 316L (welded products) stainless steel as specified and referenced in Section III of the ASME Boiler and Pressure Vessel code.

The American Society of Mechanical Engineers (ASME) Boiler and Vessel Code, Section III, latest issue, entitled Rules for Construction of Nuclear Power Plant Components, is the principal document covering this type of fitting in the nuclear field. ANSI Standard B.31.1.0, Power Piping, and ANSI Standard B.31.7, Nuclear Power Piping, are also important documents in the field.

In addition to the documentation of chemical and physical properties, great care is taken throughout the manufacture of Parker's tube fittings to ensure that potential stress corrosion will not be a problem in normal usage of the parts. Manufacturing processes avoid exposure of the parts to mercury or halogens, and control of thermal treatment avoids the condition known as continuous grain boundary carbide precipitation.

**For additional information please contact your local authorized Parker Instrumentation distributor or call Parker Instrumentation Connectors Division and ask for Bulletin 4230-B15.**







## Offer of Sale

The items described in this document and other documents and descriptions provided by Parker Hannifin Corporation, its subsidiaries and its authorized distributors ("Seller") are hereby offered for sale at prices to be established by Seller. This offer and its acceptance by any customer ("Buyer") shall be governed by all of the following Terms and Conditions. Buyer's order for any item described in its document, when communicated to Seller verbally, or in writing, shall constitute acceptance of this offer. All goods or work described will be referred to as "Products".

**1. Terms and Conditions.** Seller's willingness to offer Products, or accept an order for Products, to or from Buyer is expressly conditioned on Buyer's assent to these Terms and Conditions and to the terms and conditions found on-line at [www.parker.com/saleterms/](http://www.parker.com/saleterms/). Seller objects to any contrary or additional term or condition of Buyer's order or any other document issued by Buyer.

**2. Price Adjustments; Payments.** Prices stated on the reverse side or preceding pages of this document are valid for 30 days. After 30 days, Seller may change prices to reflect any increase in its costs resulting from state, federal or local legislation, price increases from its suppliers, or any change in the rate, charge, or classification of any carrier. The prices stated on the reverse or preceding pages of this document do not include any sales, use, or other taxes unless so stated specifically. Unless otherwise specified by Seller, all prices are F.O.B. Seller's facility, and payment is due 30 days from the date of invoice. After 30 days, Buyer shall pay interest on any unpaid invoices at the rate of 1.5% per month or the maximum allowable rate under applicable law.

**3. Delivery Dates; Title and Risk; Shipment.** All delivery dates are approximate and Seller shall not be responsible for any damages resulting from any delay. Regardless of the manner of shipment, title to any products and risk of loss or damage shall pass to Buyer upon tender to the carrier at Seller's facility (i.e., when it's on the truck, it's yours). Unless otherwise stated, Seller may exercise its judgment in choosing the carrier and means of delivery. No deferment of shipment at Buyers' request beyond the respective dates indicated will be made except on terms that will indemnify, defend and hold Seller harmless against all loss and additional expense. Buyer shall be responsible for any additional shipping charges incurred by Seller due to Buyer's changes in shipping, product specifications or in accordance with Section 13, herein.

**4. Warranty.** Seller warrants that the Products sold hereunder shall be free from defects in material or workmanship for a period of twelve months from the date of delivery to Buyer or 2,000 hours of normal use, whichever occurs first. This warranty is made only to Buyer and does not extend to anyone to whom Products are sold after purchased from Seller. The prices charged for Seller's products are based upon the exclusive limited warranty stated above, and upon the following disclaimer: **DISCLAIMER OF WARRANTY: THIS WARRANTY COMPRISES THE SOLE AND ENTIRE WARRANTY PERTAINING TO PRODUCTS PROVIDED HEREUNDER. SELLER DISCLAIMS ALL OTHER WARRANTIES, EXPRESS AND IMPLIED, INCLUDING MERCHANTABILITY AND FITNESS FOR A PARTICULAR PURPOSE.**

**5. Claims; Commencement of Actions.** Buyer shall promptly inspect all Products upon delivery. No claims for shortages will be allowed unless reported to the Seller within 10 days of delivery. No other claims against Seller will

be allowed unless asserted in writing within 60 days after delivery or, in the case of an alleged breach of warranty, within 30 days after the date within the warranty period on which the defect is or should have been discovered by Buyer. Any action based upon breach of this agreement or upon any other claim arising out of this sale (other than an action by Seller for any amount due to Seller from Buyer) must be commenced within thirteen months from the date of tender of delivery by Seller or, for a cause of action based upon an alleged breach of warranty, within thirteen months from the date within the warranty period on which the defect is or should have been discovered by Buyer.

**6. LIMITATION OF LIABILITY.** UPON NOTIFICATION, SELLER WILL, AT ITS OPTION, REPAIR OR REPLACE A DEFECTIVE PRODUCT, OR REFUND THE PURCHASE PRICE. IN NO EVENT SHALL SELLER BE LIABLE TO BUYER FOR ANY SPECIAL, INDIRECT, INCIDENTAL OR CONSEQUENTIAL DAMAGES ARISING OUT OF, OR AS THE RESULT OF, THE SALE, DELIVERY, NON-DELIVERY, SERVICING, USE OR LOSS OF USE OF THE PRODUCTS OR ANY PART THEREOF, OR FOR ANY CHARGES OR EXPENSES OF ANY NATURE INCURRED WITHOUT SELLER'S WRITTEN CONSENT, EVEN IF SELLER HAS BEEN NEGLIGENT, WHETHER IN CONTRACT, TORT OR OTHER LEGAL THEORY. IN NO EVENT SHALL SELLER'S LIABILITY UNDER ANY CLAIM MADE BY BUYER EXCEED THE PURCHASE PRICE OF THE PRODUCTS.

**7. Contingencies.** Seller shall not be liable for any default or delay in performance if caused by circumstances beyond the reasonable control of Seller.

**8. User Responsibility.** The user, through its own analysis and testing, is solely responsible for making the final selection of the system and Product and assuring that all performance, endurance, maintenance, safety and warning requirements of the application are met. The user must analyze all aspects of the application and follow applicable industry standards and Product information. If Seller provides Product or system options, the user is responsible for determining that such data and specifications are suitable and sufficient for all applications and reasonably foreseeable uses of the Products or systems.

**9. Loss to Buyer's Property.** Any designs, tools, patterns, materials, drawings, confidential information or equipment furnished by Buyer or any other items which become Buyer's property, may be considered obsolete and may be destroyed by Seller after two consecutive years have elapsed without Buyer placing an order for the items which are manufactured using such property. Seller shall not be responsible for any loss or damage to such property while it is in Seller's possession or control.

**10. Special Tooling.** A tooling charge may be imposed for any special tooling, including without limitation, dies, fixtures, molds and patterns, acquired to manufacture Products.

Such special tooling shall be and remain Seller's property notwithstanding payment of any charges by Buyer. In no event will Buyer acquire any interest in apparatus belonging to Seller which is utilized in the manufacture of the Products, even if such apparatus has been specially converted or adapted for such manufacture and notwithstanding any charges paid by Buyer. Unless otherwise agreed, Seller shall have the right to alter, discard or otherwise dispose of any special tooling or other property in its sole discretion at any time.

**11. Buyer's Obligation; Rights of Seller.** To secure payment of all sums due or otherwise, Seller shall retain a security interest in the goods delivered and this agreement shall be deemed a Security Agreement under the Uniform Commercial Code. Buyer authorizes Seller as its attorney to execute and file on Buyer's behalf all documents Seller deems necessary to perfect its security interest. Seller shall have a security interest in, and lien upon, any property of Buyer in Seller's possession as security for the payment of any amounts owed to Seller by Buyer.

**12. Improper use and Indemnity.** Buyer shall indemnify, defend, and hold Seller harmless from any claim, liability, damages, lawsuits, and costs (including attorney fees), whether for personal injury, property damage, patent, trademark or copyright infringement or any other claim, brought by or incurred by Buyer, Buyer's employees, or any other person, arising out of: (a) improper selection, improper application or other misuse of Products purchased by Buyer from Seller; (b) any act or omission, negligent or otherwise, of Buyer; (c) Seller's use of patterns, plans, drawings, or specifications furnished by Buyer to manufacture Product; or (d) Buyer's failure to comply with these terms and conditions. Seller shall not indemnify Buyer under any circumstance except as otherwise provided.

**13. Cancellations and Changes.** Orders shall not be subject to cancellation or change by Buyer for any reason, except with Seller's written consent and upon terms that will indemnify, defend and hold Seller harmless against all direct, incidental and consequential loss or damage. Seller may change product features, specifications, designs and availability with notice to Buyer.

**14. Limitation on Assignment.** Buyer may not assign its rights or obligations under this agreement without the prior written consent of Seller.

**15. Entire Agreement.** This agreement contains the entire agreement between the Buyer and Seller and constitutes the final, complete and exclusive expression of the terms of the agreement. All prior or contemporaneous written or oral agreements or negotiations with respect to the subject matter are herein merged.

**16. Waiver and Severability.** Failure to enforce any provision of this agreement will not waive that provision nor will any such failure prejudice Seller's right to enforce that provision in the future. Invalidation of any provision of this agreement by legislation or other rule of law shall not invalidate any other provision herein. The remaining provisions of this agreement will remain in full force and effect.

**17. Termination.** This agreement may be terminated by Seller for any reason and at any time by giving Buyer thirty (30) days written notice of termination. In addition, Seller may

by written notice immediately terminate this agreement for the following: (a) Buyer commits a breach of any provision of this agreement (b) the appointment of a trustee, receiver or custodian for all or any part of Buyer's property (c) the filing of a petition for relief in bankruptcy of the other Party on its own behalf, or by a third party (d) an assignment for the benefit of creditors, or (e) the dissolution or liquidation of the Buyer.

**18. Governing Law.** This agreement and the sale and delivery of all Products hereunder shall be deemed to have taken place in and shall be governed and construed in accordance with the laws of the State of Ohio, as applicable to contracts executed and wholly performed therein and without regard to conflicts of laws principles. Buyer irrevocably agrees and consents to the exclusive jurisdiction and venue of the courts of Cuyahoga County, Ohio with respect to any dispute, controversy or claim arising out of or relating to this agreement. Disputes between the parties shall not be settled by arbitration unless, after a dispute has arisen, both parties expressly agree in writing to arbitrate the dispute.

**19. Indemnity for Infringement of Intellectual Property Rights.** Seller shall have no liability for infringement of any patents, trademarks, copyrights, trade dress, trade secrets or similar rights except as provided in this Section. Seller will defend and indemnify Buyer against allegations of infringement of U.S. patents, U.S. trademarks, copyrights, trade dress and trade secrets ("Intellectual Property Rights"). Seller will defend at its expense and will pay the cost of any settlement or damages awarded in an action brought against Buyer based on an allegation that a Product sold pursuant to this Agreement infringes the Intellectual Property Rights of a third party. Seller's obligation to defend and indemnify Buyer is contingent on Buyer notifying Seller within ten (10) days after Buyer becomes aware of such allegations of infringement, and Seller having sole control over the defense of any allegations or actions including all negotiations for settlement or compromise. If a Product is subject to a claim that it infringes the Intellectual Property Rights of a third party, Seller may, at its sole expense and option, procure for Buyer the right to continue using the Product, replace or modify the Product so as to make it noninfringing, or offer to accept return of the Product and return the purchase price less a reasonable allowance for depreciation. Notwithstanding the foregoing, Seller shall have no liability for claims of infringement based on information provided by Buyer, or directed to Products delivered hereunder for which the designs are specified in whole or part by Buyer, or infringements resulting from the modification, combination or use in a system of any Product sold hereunder. The foregoing provisions of this Section shall constitute Seller's sole and exclusive liability and Buyer's sole and exclusive remedy for infringement of Intellectual Property Rights.

**20. Taxes.** Unless otherwise indicated, all prices and charges are exclusive of excise, sales, use, property, occupational or like taxes which may be imposed by any taxing authority upon the manufacture, sale or delivery of Products.

**21. Equal Opportunity Clause.** For the performance of government contracts and where dollar value of the Products exceed \$10,000, the equal employment opportunity clauses in Executive Order 11246, VEVRAA, and 41 C.F.R. §§ 60-1.4(a), 60-741.5(a), and 60-250.4, are hereby incorporated.

# Parker's Motion & Control Technologies

At Parker, we're guided by a relentless drive to help our customers become more productive and achieve higher levels of profitability by engineering the best systems for their requirements. It means looking at customer applications from many angles to find new ways to create value. Whatever the motion and control technology need, Parker has the experience, breadth of product and global reach to consistently deliver. No company knows more about motion and control technology than Parker. For further info call 1-800-C-Parker.



## AEROSPACE

### Key Markets

- Aircraft engines
- Business & general aviation
- Commercial transports
- Land-based weapons systems
- Military aircraft
- Missiles & launch vehicles
- Regional transports
- Unmanned aerial vehicles

### Key Products

- Flight control systems & components
- Fluid conveyance systems
- Fluid metering delivery & atomization devices
- Fuel systems & components
- Hydraulic systems & components
- Inert nitrogen generating systems
- Pneumatic systems & components
- Wheels & brakes



## CLIMATE CONTROL

### Key Markets

- Agriculture
- Air conditioning
- Food, beverage & dairy
- Life sciences & medical
- Precision cooling
- Processing
- Transportation

### Key Products

- CO<sub>2</sub> controls
- Electronic controllers
- Filter driers
- Hand shut-off valves
- Hose & fittings
- Pressure regulating valves
- Refrigerant distributors
- Safety relief valves
- Solenoid valves
- Thermostatic expansion valves

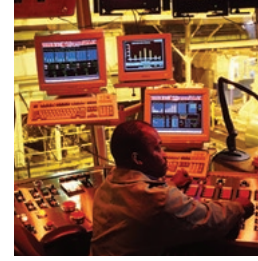

## ELECTROMECHANICAL

### Key Markets

- Aerospace
- Factory automation
- Life science & medical
- Machine tools
- Packaging machinery
- Paper machinery
- Plastics machinery & converting
- Primary metals
- Semiconductor & electronics
- Textile
- Wire & cable

### Key Products

- AC/DC drives & systems
- Electric actuators, gantry robots & slides
- Electrohydraulic actuation systems
- Electromechanical actuation systems
- Human machine interface
- Linear motors
- Stepper motors, servo motors, drives & controls
- Structural extrusions



## FILTRATION

### Key Markets

- Food & beverage
- Industrial machinery
- Life sciences
- Marine
- Mobile equipment
- Oil & gas
- Power generation
- Process
- Transportation

### Key Products

- Analytical gas generators
- Compressed air & gas filters
- Condition monitoring
- Engine air, fuel & oil filtration & systems
- Hydraulic, lubrication & coolant filters
- Process, chemical, water & microfiltration filters
- Nitrogen, hydrogen & zero air generators



## FLUID & GAS HANDLING

### Key Markets

- Aerospace
- Agriculture
- Bulk chemical handling
- Construction machinery
- Food & beverage
- Fuel & gas delivery
- Industrial machinery
- Mobile
- Oil & gas
- Transportation
- Welding

### Key Products

- Brass fittings & valves
- Diagnostic equipment
- Fluid conveyance systems
- Industrial hose
- PTFE & PFA hose, tubing & plastic fittings
- Rubber & thermoplastic hose & couplings
- Tube fittings & adapters
- Quick disconnects



## HYDRAULICS

### Key Markets

- Aerospace
- Aerial lift
- Agriculture
- Construction machinery
- Forestry
- Industrial machinery
- Mining
- Oil & gas
- Power generation & energy
- Truck hydraulics

### Key Products

- Diagnostic equipment
- Hydraulic cylinders & accumulators
- Hydraulic motors & pumps
- Hydraulic systems
- Hydraulic valves & controls
- Power take-offs
- Rubber & thermoplastic hose & couplings
- Tube fittings & adapters
- Quick disconnects

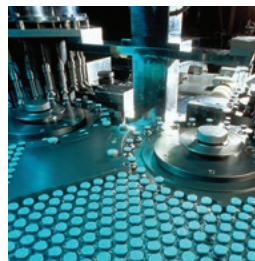

## PNEUMATICS

### Key Markets

- Aerospace
- Conveyor & material handling
- Factory automation
- Life science & medical
- Machine tools
- Packaging machinery
- Transportation & automotive

### Key Products

- Air preparation
- Brass fittings & valves
- Manifolds
- Pneumatic accessories
- Pneumatic actuators & grippers
- Pneumatic valves & controls
- Quick disconnects
- Rotary actuators
- Rubber & thermoplastic hose & couplings
- Structural extrusions
- Thermoplastic tubing & fittings
- Vacuum generators, cups & sensors



## PROCESS CONTROL

### Key Markets

- Chemical & refining
- Food, beverage & dairy
- Medical & dental
- Microelectronics
- Oil & gas
- Power generation

### Key Products

- Analytical sample conditioning products & systems
- Fluoropolymer chemical delivery fittings, valves & pumps
- High purity gas delivery fittings, valves & regulators
- Instrumentation fittings, valves & regulators
- Medium pressure fittings & valves
- Process control manifolds



## SEALING & SHIELDING

### Key Markets

- Aerospace
- Chemical processing
- Consumer
- Energy, oil & gas
- Fluid power
- General industrial
- Information technology
- Life sciences
- Military
- Semiconductor
- Telecommunications
- Transportation

### Key Products

- Dynamic seals
- Elastomeric o-rings
- EMI shielding
- Extruded & precision-cut, fabricated elastomeric seals
- Homogeneous & inserted elastomeric shapes
- High temperature metal seals
- Metal & plastic retained composite seals
- Thermal management



ENGINEERING YOUR SUCCESS.

# Parker Worldwide

## Europe, Middle East, Africa

**AE – United Arab Emirates,**  
Dubai  
Tel: +971 4 8127100  
parker.me@parker.com

**AT – Austria,** Wiener Neustadt  
Tel: +43 (0)2622 23501-0  
parker.austria@parker.com

**AT – Eastern Europe,** Wiener  
Neustadt  
Tel: +43 (0)2622 23501 900  
parker.easteurope@parker.com

**AZ – Azerbaijan,** Baku  
Tel: +994 50 2233 458  
parker.azerbaijan@parker.com

**BE/LU – Belgium,** Nivelles  
Tel: +32 (0)67 280 900  
parker.belgium@parker.com

**BG – Bulgaria,** Sofia  
Tel: +359 2 980 1344  
parker.bulgaria@parker.com

**BY – Belarus,** Minsk  
Tel: +375 17 209 9399  
parker.belarus@parker.com

**CH – Switzerland,** Etoy  
Tel: +41 (0)21 821 87 00  
parker.switzerland@parker.com

**CZ – Czech Republic,** Klecany  
Tel: +420 284 083 111  
parker.czechrepublic@parker.com

**DE – Germany,** Kaarst  
Tel: +49 (0)2131 4016 0  
parker.germany@parker.com

**DK – Denmark,** Ballerup  
Tel: +45 43 56 04 00  
parker.denmark@parker.com

**ES – Spain,** Madrid  
Tel: +34 902 330 001  
parker.spain@parker.com

**FI – Finland,** Vantaa  
Tel: +358 (0)20 753 2500  
parker.finland@parker.com

**FR – France,** Contamine s/Arve  
Tel: +33 (0)4 50 25 80 25  
parker.france@parker.com

**GR – Greece,** Athens  
Tel: +30 210 933 6450  
parker.greece@parker.com

**HU – Hungary,** Budaörs  
Tel: +36 23 885 470  
parker.hungary@parker.com

**IE – Ireland,** Dublin  
Tel: +353 (0)1 466 6370  
parker.ireland@parker.com

**IT – Italy,** Corsico (MI)  
Tel: +39 02 45 19 21  
parker.italy@parker.com

**KZ – Kazakhstan,** Almaty  
Tel: +7 7273 561 000  
parker.easteurope@parker.com

**NL – The Netherlands,** Oldenzaal  
Tel: +31 (0)541 585 000  
parker.nl@parker.com

**NO – Norway,** Asker  
Tel: +47 66 75 34 00  
parker.norway@parker.com

**PL – Poland,** Warsaw  
Tel: +48 (0)22 573 24 00  
parker.poland@parker.com

**PT – Portugal,** Leca da Palmeira  
Tel: +351 22 999 7360  
parker.portugal@parker.com

**RO – Romania,** Bucharest  
Tel: +40 21 252 1382  
parker.romania@parker.com

**RU – Russia,** Moscow  
Tel: +7 495 645-2156  
parker.russia@parker.com

**SE – Sweden,** Spånga  
Tel: +46 (0)8 59 79 50 00  
parker.sweden@parker.com

**SK – Slovakia,** Banská Bystrica  
Tel: +421 484 162 252  
parker.slovakia@parker.com

**SL – Slovenia,** Novo Mesto  
Tel: +386 7 337 6650  
parker.slovenia@parker.com

**TR – Turkey,** Istanbul  
Tel: +90 216 4997081  
parker.turkey@parker.com

**UA – Ukraine,** Kiev  
Tel: +380 44 494 2731  
parker.ukraine@parker.com

**UK – United Kingdom,** Warwick  
Tel: +44 (0)1926 317 878  
parker.uk@parker.com

**ZA – South Africa,** Kempton Park  
Tel: +27 (0)11 961 0700  
parker.southafrica@parker.com

## North America

**CA – Canada,** Milton, Ontario  
Tel: +1 905 693 3000

**US – USA,** Cleveland  
Tel: +1 216 896 3000

## Asia Pacific

**AU – Australia,** Castle Hill  
Tel: +61 (0)2-9634 7777

**CN – China,** Shanghai  
Tel: +86 21 2899 5000

**HK – Hong Kong**  
Tel: +852 2428 8008

**IN – India,** Mumbai  
Tel: +91 22 6513 7081-85

**JP – Japan,** Tokyo  
Tel: +81 (0)3 6408 3901

**KR – South Korea,** Seoul  
Tel: +82 2 559 0400

**MY – Malaysia,** Shah Alam  
Tel: +60 3 7849 0800

**NZ – New Zealand,** Mt Wellington  
Tel: +64 9 574 1744

**SG – Singapore**  
Tel: +65 6887 6300

**TH – Thailand,** Bangkok  
Tel: +662 186 7000-99

**TW – Taiwan,** Taipei  
Tel: +886 2 2298 8987

## South America

**AR – Argentina,** Buenos Aires  
Tel: +54 3327 44 4129

**BR – Brazil,** Sao Jose dos Campos  
Tel: +55 800 727 5374

**CL – Chile,** Santiago  
Tel: +56 2 623 1216

**MX – Mexico,** Toluca  
Tel: +52 72 2275 4200

