



EN Operating instructions. pages 1 to 8
Original

Content

1 About this document

1.1 Function 1

1.2 Target group: authorised qualified personnel. 1

1.3 Explanation of the symbols used 1

1.4 Appropriate use 1

1.5 General safety instructions 1

1.6 Warning about misuse 2

1.7 Exclusion of liability 2

2 Product description

2.1 Ordering code 2

2.2 Special versions. 2

2.3 Purpose 2

2.4 Technical data 3

2.5 Safety classification of the interlocking function. 3

2.6 Safety classification of the guard locking function 4

3 Mounting

3.1 General mounting instructions 4

3.2 Dimensions 4

4 Electrical connection

4.1 General information for electrical connection. 4

5 Functions and configuration

5.1 Mode of operation of the safety outputs. 5

5.2 Magnet control 5

5.3 Programming the slave address 5

5.4 Configuration of the safety monitor 5

5.5 Status signal "safety release" 5

5.6 Read-out of the parameter port 5

6 Set-up and maintenance

6.1 Functional testing. 7

6.2 Maintenance 7

7 Disassembly and disposal

7.1 Disassembly. 7

7.2 Disposal 7

8 EU Declaration of conformity

1. About this document

1.1 Function

This operating instructions manual provides all the information you need for the mounting, set-up and commissioning to ensure the safe operation and disassembly of the safety switchgear. The operating instructions must be available in a legible condition and a complete version in the vicinity of the device.

1.2 Target group: authorised qualified personnel

All operations described in this operating instructions manual must be carried out by trained specialist personnel, authorised by the plant operator only.

Please make sure that you have read and understood these operating instructions and that you know all applicable legislations regarding occupational safety and accident prevention prior to installation and putting the component into operation.

The machine builder must carefully select the harmonised standards to be complied with as well as other technical specifications for the selection, mounting and integration of the components.

1.3 Explanation of the symbols used



Information, hint, note:

This symbol is used for identifying useful additional information.



Caution: Failure to comply with this warning notice could lead to failures or malfunctions.

Warning: Failure to comply with this warning notice could lead to physical injury and/or damage to the machine.

1.4 Appropriate use

The products described in these operating instructions are developed to execute safety-related functions as part of an entire plant or machine. It is the responsibility of the manufacturer of a machine or plant to ensure the correct functionality of the entire machine or plant.

The safety switchgear must be exclusively used in accordance with the versions listed below or for the applications authorised by the manufacturer. Detailed information regarding the range of applications can be found in the chapter "Product description".

1.5 General safety instructions

The user must observe the safety instructions in this operating instructions manual, the country specific installation standards as well as all prevailing safety regulations and accident prevention rules.



Further technical information can be found in the Schmersal catalogues or in the online catalogue on the Internet: products.schmersal.com.

The information contained in this operating instructions manual is provided without liability and is subject to technical modifications.

There are no residual risks, provided that the safety instructions as well as the instructions regarding mounting, commissioning, operation and maintenance are observed.

1.6 Warning about misuse



In case of improper use or manipulation of the safety switch-gear, personal hazards or damages to machinery or plant components cannot be excluded. The relevant requirements of the standard EN ISO 14119 must be observed.

1.7 Exclusion of liability

We shall accept no liability for damages and malfunctions resulting from defective mounting or failure to comply with this operating instructions manual. The manufacturer shall accept no liability for damages resulting from the use of unauthorised spare parts or accessories.

For safety reasons, invasive work on the device as well as arbitrary repairs, conversions and modifications to the device are strictly forbidden, the manufacturer shall accept no liability for damages resulting from such invasive work, arbitrary repairs, conversions and/or modifications to the device.

2. Product description

2.1 Ordering code

This operating instructions manual applies to the following types:

AZM 161 ① ②-AS ③④⑤⑥

No.	Option	Description
①	Z	Solenoid interlock monitored
	B	Actuator monitored
	BZ	Combined actuator/solenoid interlock monitoring
②	ST1	Connector in the middle
	ST2	Connector at the right-hand side
③		Latching force 5 N
	R	Latching force 30 N
④		Power to unlock
	A	Power to lock
⑤		Magnet supply from AS-Interface
	P	Magnet supply 24 VDC (AUX)
⑥		Manual release
	N	Emergency release
	T	Emergency exit



Only if the information described in this operating instructions manual are realised correctly, the safety function and therefore the compliance with the Machinery Directive is maintained.

2.2 Special versions

For special versions, which are not listed in the order code below 2.1, these specifications apply accordingly, provided that they correspond to the standard version.

2.3 Purpose

The AZM 161 AS is designed for use with AS-Interface Safety at Work.



The safety switchgears are classified according to EN ISO 14119 as type 2 interlocking devices.

The different variants can be used as safety switch with interlocking function either as solenoid interlock for the position monitoring and locking of movable safety guards.



Interlocks with power to lock principle may only be used in special cases after a thorough evaluation of the accident risk, since the safety guard can be opened immediately on failure of the power supply or upon activation of the main switch.



If the risk analysis indicates the use of a monitored interlock then a variant with the monitored interlock is to be used, marked with the symbol in the ordering code. The actuator monitoring variant (B) is a safety switch with an interlock function for process protection.

The safety function of the safety switchgear consists of safely switching off the code transfer when the guard system is unlocked or opened and maintaining the safe switched off condition for as long as the guard system is unlocked or open.

An AS-Interface Safety at Work component functions on the basis of an individual code generator (8 x 4 bit). This safety code is cyclically transmitted over the AS-i network and monitored by the safety monitor.

The component status can be evaluated through a PLC with AS-Interface master. The safety-related functions are enabled by means of the AS-i safety monitor.

LED display

The LEDs have the following meaning (to EN 62026-2):

- Yellow LED:** Channel 1 / AS-i SaW bit 0,1
- Green-red LED:** AS-Interface supply voltage/
(AS-i duo LED) AS-Interface communication error or
slave address = 0 or periphery error
- Yellow LED:** Channel 2 / AS-i SaW bit 2,3

Manual release

A manual release is available as a mounting tool and in the event of a power failure in case the power to unlock principle is used. The manual release is realised by turning the triangular key by 180°, so that the locking bolt is pulled into the unlocking position. Please ensure that jamming by external influence on the actuator is avoided. The normal locking function is only restored after the triangular key has been returned to its original position. After being put into operation, the manual release must be secured by installing the plastic cover, which is included in delivery.

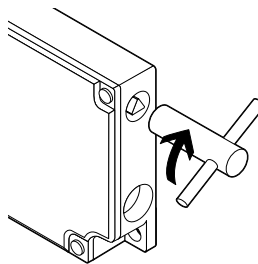

Triangular key TK-M5 (101100887) available as accessory.

Emergency release (ordering suffix -N)

(Fitting and actuation only from outside the hazardous area)



The emergency release should only be used in an emergency. The solenoid interlock should be installed and/or protected so that an inadvertent opening of the interlock by an emergency release can be prevented. The solenoid interlock should be installed and/or protected so that an inadvertent opening of the interlock by an emergency release can be prevented. The emergency release must be clearly labelled that it should only be used in an emergency. The label can be used that was included in the delivery.

To realise an emergency release, turn the orange lever by 180° in the direction shown by the arrow until it hits the end stop. In this position, the safety guard can be opened. The lever is latched and cannot be turned back. To cancel the blocking condition, the central mounting screw must be loosened to such extent that the lever can be turned back into its original position. Return the lever to its original position and firmly retighten the screw.

Emergency exit (Ordering suffix -T)

(Fitting and actuation only from within the hazardous area)

To realise an emergency exit, turn the orange lever by 180° in the direction shown by the arrow until it hits the end stop. In this position, the safety guard can be opened. The blocked position is cancelled by turning the lever in the opposite direction. In unlocked position, the safety guard is protected against unintentional closing.

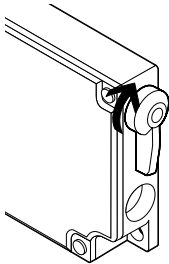

Emergency release (N)

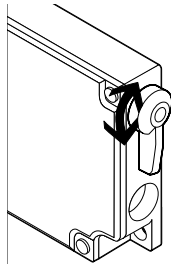

Emergency exit (T)



The user must evaluate and design the safety chain in accordance with the relevant standards and the required safety level.



The entire concept of the control system, in which the safety component is integrated, must be validated to the relevant standards.

2.4 Technical data

Standards:	EN 60947-5-1, EN ISO 14119, EN 62026-2, EN ISO 13849-1, EN 61508
Enclosure:	glass-fibre reinforced thermoplastic, self-extinguishing
Actuator and locking bolt:	stainless steel 1.4301
Coding level according to EN ISO 14119:	low
Switching frequency:	≤ 1 Hz
Response time:	≤ 100 ms
Duration of risk:	≤ 200 ms
Time to readiness:	≤ 2 s
Mechanical data	
Connection:	Connector plug M12, 4-pole, A-coded
Mechanical life:	> 1 million operations
Actuating speed:	≤ 2 m/s
Holding force F_{max} :	2,600 N
Holding force F_{Zh} :	2,000 N
Latching force:	30 N, only for option R
Ambient conditions	
Ambient temperature:	-25 °C ... +60 °C
Storage and transport temperature:	-25 °C ... +85 °C
Relative humidity:	30 % ... 95 %, non condensing
Resistance to vibration:	10 ... 150 Hz, Amplitude 0.35 mm

Resistance to shock:	30 g / 11 ms
Protection class:	IP67 to EN 60529
Installation altitude above sea level:	≤ 2,000 m
Protection rating:	II,
Insulation values to EN 60664-1:	
- Rated insulation voltage U_i :	32 VDC
- Rated impulse withstand voltage U_{imp} :	0.8 kV
- Over-voltage category:	III
- Degree of pollution:	3

Electrical data – AS-Interface

AS-i operating voltage:	18.0 - 31.6 V DC, protection against polarity reversal
AS-interface power consumption:	≤ 0.25 A
- ordering suffix "P":	≤ 0.1 A
AS-i device insulation:	internal short-circuit proof
AS-i specification:	
- Version:	V 2.1
- Profile:	S-7.B.F.E
AS-i inputs:	
- Channel 1:	Data bits DI 0/DI 1
- Channel 2:	Data bits DI 2/DI 3
	Databits condition static 0 or dynamic code transmission

AS-i outputs:

- DO 0:	Magnetically controlled locking
- DO 1 ... DO 3:	No function

AS-i parameter bits:

- P0:	Door and actuator detected
- P1:	Interlock locked
- P2:	Auxiliary voltage U_{AUX} in tolerance range
- P3:	Error message "locking/unlocking of the solenoid interlock blocked"

Parameter request: default value parameter request "1111" (0xF)

AS-i Input module address: 0

- preset to address 0, can be changed through AS-interface bus master or hand-held programming device

Electrical data – auxiliary voltage (AUX) order index "p"

Operating voltage U_B :	24 VDC -15 % / +10 %, protection against polarity reversal (stabilised PELV units)
---------------------------	--

Power consumption AUX: ≤ 0.5 A

Magnet switch-on time: 100 %

Device fuse rating AUX: 4 A gG when used to UL 508

LED status display

LED yellow:	Channel 1 / AS-i SaW Bit 0, 1
LED green/red (AS-i Duo LED):	Supply voltage / Kommunikationsfehler / Slave address = 0 / Peripheral error set
LED yellow:	Channel 2 / AS-i SaW Bit 2, 3

Use Type 4X (Indoor Use) and 12 connector fittings.

2.5 Safety classification of the interlocking function

Standards: EN ISO 13849-1, EN 61508

Intended structure:

- If a fault exclusion of a hazardous damage to the 1-channel mechanics is authorised and sufficient protection against tampering is ensured:	applicable up to cat. 3 / PL d / SIL 2
- PFH:	1.01×10^{-7} / h for ≤ 100,000 operations / year
- Basically:	applicable up to cat. 1 / PL c / SIL 1
- PFH:	1.14×10^{-6} / h for ≤ 100,000 operations / year
Mission time:	20 years

2.6 Safety classification of the guard locking function

If the device is used as an interlock for personal safety, a safety classification of the guard locking function is required.

When classifying the interlock function, a distinction must be made between monitoring of the interlock function (locking function) and controlling the unlocking function.

The following safety classification of the unlocking function is based on the application of the principle of safety energy disconnection for the solenoid supply



The safety classification for the release function only applies to devices with monitored interlock function, in power to unlock version and with solenoid supply from 24 VDC (AUX) (see ordering code).

By reliably isolating the power externally, it can be assumed that no errors can occur with regard to the locking device of the interlock.

In this case, the locking device of the solenoid interlock does not have an effect on the failure probability of the unlock function.

The safety level of the unlock function is determined exclusively by the external safety power shutdown.

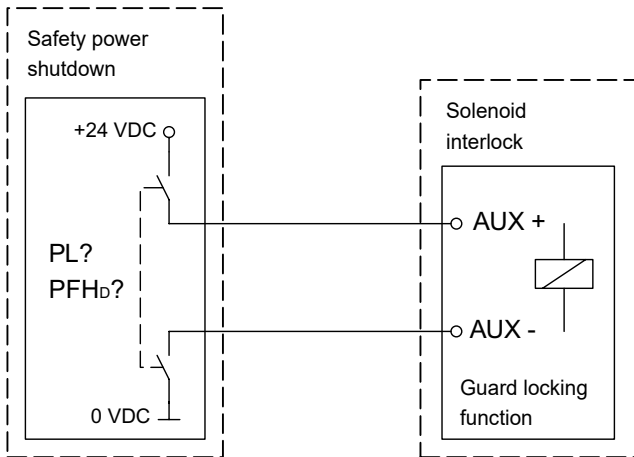

Fault exclusion with regard to wiring routing must be observed.



If for a certain application the power to unlock version of a solenoid interlock cannot be used, for this exception an interlock with power to lock can be used if additional safety measure need to be realised that have an equivalent safety level.

3. Mounting

3.1 General mounting instructions

Three mounting holes are provided for fixing the enclosure. The solenoid interlock is double insulated. The use of an earth wire is not authorised. The solenoid interlock must not be used as an end stop. Any mounting position. The mounting position however must be chosen so that the ingress of dirt and soiling in the used opening is avoided. Unused actuator openings must be sealed with slot sealing plugs.



The actuator must be permanently fitted to the safety guards and protected against displacement by suitable measures (tamperproof screws, gluing, drilling of the screw heads).



Please observe the remarks of the standards EN ISO 12100, EN ISO 14119 and EN ISO 14120.

3.2 Dimensions

All measurements in mm.

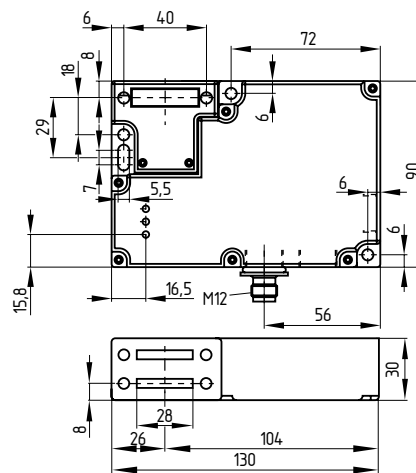

4. Electrical connection

4.1 General information for electrical connection



The electrical connection may only be carried out by authorised personnel in a de-energised condition.

The AZM 161 AS is supplied from the AS-Interface cable. The energy for the locking magnets is either supplied separately (AUX) (ordering suffix P) or through the AS-Interface cable. Both voltage supplies of the solenoid interlock must be equipped with a protection against permanent overvoltage. To that effect, stabilised PELV supply units must be used.

The connection to the AS-Interface system is realised through an M12 connector. The M12 connector is A-coded. The wiring configuration is defined as follows (to EN 62026-2):

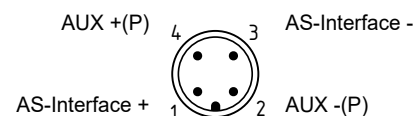

5. Functions and configuration

5.1 Mode of operation of the safety outputs

AZM 161 Z ST-AS

The safety outputs of the AS-i safety monitor are enabled, when the following conditions are met:

- the actuator is inserted
- the solenoid interlock is locked

AZM 161 B ST-AS

The safety outputs of the AS-i safety monitor are enabled, when the following conditions are met:

- the actuator is inserted

AZM 161 BZ ST-AS

The safety outputs of the AS-i safety monitor are only activated, when both AS-i half-codes are enabled.

Half-code 1 (AS-i SaW bit 0,1) is enabled, when:

- the actuator is inserted

The solenoid interlock now can be locked.

Half-code 2 (AS-i SaW bit 2,3) is enabled, when:

- the solenoid interlock is additionally locked.

5.2 Magnet control

The control system with the AS-Interface Master can lock and unlock the solenoid interlock through the output bit 0 of the addressed AS-i slave AZM 161 AS. In the power to lock variant of the AZM 161 AS, the functional set of output bit 0 will cause the solenoid interlock to be locked. In the power to unlock variant of the AZM 161 AS, the functional set of output bit 0 will cause the solenoid interlock to be unlocked.

5.3 Programming the slave address

The slave address is programmed through the M12 connector.

Any address from 1 to 31 can be set by means of the AS-i bus master or a hand-held programming device.

5.4 Configuration of the safety monitor

Depending on the component used, the AZM 161 AS can be configured in the ASIMON configuration software with the following monitoring devices (also refer to the ASIMON manual).

Double channel dependent with filtering

Suitable for: AZM 161 B ST-AS

The use of this monitoring device is especially advantageous on safety guards where bounce or vibration against the mechanical stop upon closing is a problem.

- Optionally with startup test
- Stabilisation time typically 0.5 up to 1.0 s
- Synchronisation time typically 5.0 up to 10 s

The safety-monitoring module is only released after expiration of the stabilising time; the synchronization time always must exceed the stabilising time.

Double channel conditionally dependent

Suitable for: AZM 161 BZ ST-AS

- Independent: In - 1

As long as the actuator remains inserted, the safety guard can be relocked at any time, in which case the safety outputs are reactivated. The safety guard must not be opened.



The redundancy and the "Safety guard closed" signal are not tested in this configuration. To test these conditions, additional measures must be taken beyond the safety monitor.

Double channel dependent

Suitable for: AZM 161 Z ST-AS, AZM 161 B ST-AS, AZM 161 BZ ST-AS

- Synchronisation time typically: 0.1 s, for AZM 161 BZ ST-AS infinite (∞)
- Optionally with startup test
- Optional with local acknowledge

When the AZM 161 BZ ST-AS is used together with this monitoring device for conducting the start-up test prior to every restart, the safety guard must be opened.



The configuration of the safety monitor must be tested and confirmed by a qualified and authorised safety expert/safety engineer.

5.5 Status signal "safety release"

The "safety release" status signal from a Safety at Work slave can be cyclically queried by the control system through the AS-i master. To that effect, the 4 input bits with the varying SaW code of a Safety at Work slave are evaluated through an OR operation with 4 inputs in the control system.

5.6 Read-out of the parameter port

The parameter port P0 to P3 of a solenoid interlock can be read out through the control interface of the AS-i master (see component description) by means of the "Write parameter" instruction (with hexadecimal value F). This non-safe diagnostic information from the reflected parameters or the answer to a "Write parameter instruction" can be used by the user for diagnostic purposes or for the control programme.

Parameter bit	Condition = 1	Condition = 0
0	Actuator inserted. The actuator can now be locked.	No actuator detected
1	Actuator inserted and locked	Actuator not locked
2	Magnet voltage available	Magnet voltage not available
3	Locking/unlocking of the solenoid interlock blocked	Locking/unlocking of the solenoid interlock not blocked

Error message "locking/unlocking of the solenoid interlock blocked"

This error is transmitted, when the solenoid interlock no longer can be correctly locked or unlocked. The causes for this error can be: the safety guard is not correctly closed, the actuator is deformed, the manual release is not correctly reset or the auxiliary voltage is missing. This error is transmitted as "periphery error" to the control system through the AS-i Master. A "periphery error" is shown on the AS-i device by the alternating red/green flashing of the AS-i Duo LED.

AZM 161 Z ST-AS . A. Z-variant, power to lock (magnet-operated locking)

System condition	Magnet input AS-i D Out: 0	Channel 1 Yellow LED	Channel 2 Yellow LED	SaW code Reset				AS-i FID Red LED	Parameter port			
				P0	P1	P2	P3					
Safety guard open	0	---	---	0	0	0	0	---	0	0	1	0
Safety guard closed	0	---	---	0	0	0	0	---	1	0	1	0
Safety guard locked	1	ON	ON	SaW code				---	1	1	1	0
Locking blocked	1	---	---	0	0	0	0	Flashes	1	0	1	1
Unlocking blocked	0	ON	ON	SaW code				Flashes	1	1	1	1

AZM 161 B ST-AS . A. B-variant, power to lock (magnet-operated locking)

System condition	Magnet input AS-i D Out: 0	Channel 1 Yellow LED	Channel 2 Yellow LED	SaW code Reset				AS-i FID Red LED	Parameter port			
				P0	P1	P2	P3					
Safety guard open	0	---	---	0	0	0	0	---	0	0	1	0
Safety guard closed	0	ON	ON	SaW code				---	1	0	1	0
Safety guard locked	1	ON	ON	SaW code				---	1	1	1	0
Locking blocked	1	ON	ON	SaW code				Flashes	1	0	1	1
Unlocking blocked	0	ON	ON	SaW code				Flashes	1	1	1	1

AZM 161 BZ ST-AS . A. BZ-variant, power to lock (magnet-operated locking)

System condition	Magnet input AS-i D Out: 0	Channel 1 Yellow LED	Channel 2 Yellow LED	SaW code Reset				AS-i FID Red LED	Parameter port			
				P0	P1	P2	P3					
Safety guard open	0	---	---	0	0	0	0	---	0	0	1	0
Safety guard closed	0	ON	---	HC1*	0	0	---	---	1	0	1	0
Safety guard locked	1	ON	ON	SaW code				---	1	1	1	0
Locking blocked	1	ON	---	HC1*	0	0	Flashes	Flashes	1	0	1	1
Unlocking blocked	0	ON	ON	SaW code				Flashes	1	1	1	1

HC1* AS-i half code 1 (AS-i SaW bit 0.1)

AZM 161 Z ST-AS Z-variant, power to unlock (spring-operated locking)

System condition	Magnet input AS-i D Out: 0	Channel 1 Yellow LED	Channel 2 Yellow LED	SaW code Reset				AS-i FID Red LED	Parameter port			
				P0	P1	P2	P3					
Safety guard open	1	---	---	0	0	0	0	---	0	0	1	0
Safety guard closed	1	---	---	0	0	0	0	---	1	0	1	0
Safety guard locked	0	ON	ON	SaW code				---	1	1	1	0
Locking blocked	0	---	---	0	0	0	0	Flashes	1	0	1	1
Unlocking blocked	1	ON	ON	SaW code				Flashes	1	1	1	1

AZM 161 B ST-AS B-variant, power to unlock (spring-operated locking)

System condition	Magnet input AS-i D Out: 0	Channel 1 Yellow LED	Channel 2 Yellow LED	SaW code Reset				AS-i FID Red LED	Parameter port			
				P0	P1	P2	P3					
Safety guard open	1	---	---	0	0	0	0	---	0	0	1	0
Safety guard closed	1	ON	ON	SaW code				---	1	0	1	0
Safety guard locked	0	ON	ON	SaW code				---	1	1	1	0
Locking blocked	0	ON	ON	SaW code				Flashes	1	0	1	1
Unlocking blocked	1	ON	ON	SaW code				Flashes	1	1	1	1

AZM 161 BZ ST-AS BZ-variant, power to unlock (spring-operated locking)

System condition	Magnet input AS-i D Out: 0	Channel 1 Yellow LED	Channel 2 Yellow LED	SaW code Reset				AS-i FID Red LED	Parameter port			
				P0	P1	P2	P3					
Safety guard open	1	---	---	0	0	0	0	---	0	0	1	0
Safety guard closed	1	ON	---	HC1*	0	0	---	---	1	0	1	0
Safety guard locked	0	ON	ON	SaW code				---	1	1	1	0
Locking blocked	0	ON	---	HC1*	0	0	Flashes	Flashes	1	0	1	1
Unlocking blocked	1	ON	ON	SaW code				Flashes	1	1	1	1

HC1* AS-i half code 1 (AS-i SaW bit 0.1)

6. Set-up and maintenance

6.1 Functional testing

The safety function of the safety components must be tested. The following conditions must be previously checked and met:

1. Check the switch enclosure for damage
2. Check for a secure installation of the actuator and the switch
3. Check the integrity of the cable entry and connections

6.2 Maintenance

A regular visual inspection and functional test, including the following steps, is recommended:

1. Check for a secure installation of the actuator and the switch
2. Remove particles of dust and soiling
3. Check cable entry and connections



Adequate measures must be taken to ensure protection against tampering either to prevent tampering of the safety guard, for instance by means of replacement actuators.

Damaged or defective components must be replaced.

7. Disassembly and disposal

7.1 Disassembly

The safety switchgear must be disassembled in a de-energised condition only.

7.2 Disposal

The safety switchgear must be disposed of in an appropriate manner in accordance with the national prescriptions and legislations.

8. EU Declaration of conformity

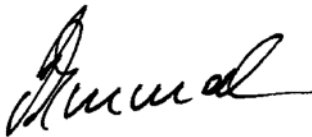
EU Declaration of conformity		
Original	K.A. Schmersal GmbH & Co. KG Möddinghofe 30 42279 Wuppertal, Germany Germany Internet: www.schmersal.com	
We hereby certify that the hereafter described components both in their basic design and construction conform to the applicable European Directives.		
Name of the component:	AZM 161 AS	
Type:	See ordering code	
Description of the component:	Interlocking device with electromagnetic interlock for safety functions with integrated AS-i Safety at Work	
Relevant Directives:	Machinery Directive	2006/42/EC
	EMC-Directive	2014/30/EU
	RoHS-Directive	2011/65/EU
Applied standards:	EN 60947-5-1:2017 EN ISO 14119:2013 EN ISO 13849-1:2015 EN 61508 parts 1-7:2010	
Person authorised for the compilation of the technical documentation:	Oliver Wacker Möddinghofe 30 42279 Wuppertal, Germany	
Place and date of issue:	Wuppertal, August 3, 2020	
		
	Authorised signature Philip Schmersal Managing Director	

AZM161AS-D-EN



The currently valid declaration of conformity can be downloaded from the internet at products.schmersal.com.

