



Servo motors

MCS synchronous servo motor

Contents

About this document	5
Document description	5
Further documents.....	5
Notations and conventions	6
Product information	7
Product description	7
Identification of the products.....	8
Features.....	8
The modular system	9
Information on project planning	10
Safety instructions	10
Basic safety instructions	10
Application as directed.....	10
Residual hazards.....	11
Drive dimensioning.....	12
Final configuration.....	17
Surface and corrosion protection.....	17
Mechanical installation	18
Important notes.....	18
Transport.....	18
Installation.....	18
Electrical installation	19
Important notes.....	19
Preparation.....	19
Technical data	20
Notes regarding the given data	20
Standards and operating conditions.....	21
Conformities and approvals.....	21
Protection of persons and device protection	21
EMC data.....	22
Environmental conditions.....	22
Radial forces and axial forces	23
Rated data	25
Inverter mains connection 400 V, Self-ventilated motors.....	25
Inverter mains connection 400 V, Forced ventilated motors	31
Inverter mains connection 230 V, Self-ventilated motors.....	35
Selection tables.....	38
Torque characteristics	64
Dimensions.....	100
Basic dimensions.....	101
Additional lengths	109
Weights	110
Basic weights.....	110
Additional weights.....	110

Contents

Product extensions	111
Motor connection.....	111
Connection via terminal box.....	111
Connection via ICN connector.....	115
Brakes.....	124
Permanent magnet brakes.....	126
Feedback.....	129
Resolver.....	130
Absolute value encoder.....	131
Blower.....	133
Temperature monitoring.....	134
Thermal detectors PT1000.....	134
Product codes	136
Environmental notes and recycling	137
Appendix	138
Good to know.....	138
Operating modes of the motor.....	138
Enclosures.....	139



About this document

Document description

This document addresses to all persons who want to carry out any configurations with the products described.

The data and information compiled in this document serve to support you in the dimensioning and selection processes and in carrying out the electrical and mechanical installation. You will receive information regarding product extensions and accessories.

- The document includes safety instructions which must be observed.
- All persons working on and with the drives must have the documentation at hand during work and observe the information and notes relevant for it.
- The documentation must always be complete and in a perfectly readable state.

Further documents



Information and tools with regard to the Lenze products can be found on the Internet:

www.Lenze.com → Downloads

About this document

Notations and conventions



Notations and conventions

This document uses the following conventions to distinguish different types of information:

Numbers			
	Decimal separator	Point	In general, the decimal point is used. Example: 1 234.56
Warning			
	UL warning	UL	Are used in English and French.
	UR warning	UR	
Text			
	Programs	» «	Software Example: »Engineer«, »EASY Starter«
Icons			
	Page reference		Reference to another page with additional information Example: 16 = see page 16
	Documentation reference		Reference to another documentation with additional information Example: EDKxxx = see documentation EDKxxx

Layout of the safety instructions

DANGER!

Indicates an extremely hazardous situation. Failure to comply with this instruction will result in severe irreparable injury and even death.

WARNING!

Indicates an extremely hazardous situation. Failure to comply with this instruction may result in severe irreparable injury and even death.

CAUTION!

Indicates a hazardous situation. Failure to comply with this instruction may result in slight to medium injury.

NOTICE

Indicates a material hazard. Failure to comply with this instruction may result in material damage.



Product information

Product description

The MCS synchronous servo motor for precisely controlled motion.

The compact synchronous servo motor for applications that require high dynamic performance, precision and compact dimensions. It can be used in the fields of positioning, robotics, and packaging technology as well as for handling systems.

In connection with the i700 and i950 servo inverters, Servo Drives 9400, and Inverter Drives 8400 TopLine, high-performance drive solutions in the torque range from 0.5 to 190 Nm can be obtained.

Customer benefit

- Compact design
- Optimum controllability and high dynamic performance thanks to low moments of inertia
- Optimal smooth running characteristics for exact work results
- The smooth housing surface makes it perfect for the use in the food industry
- Robust resolvers are included as a standard, and incremental encoders or absolute value encoders ensure a high precision
- Easy assembly and easy servicing by connectors with bayonet lock and swivel connector boxes
- Reduced cabling by One Cable Technology (OCT) in connection with digital absolute value encoders



Synchronous servo motor MCS12L20-

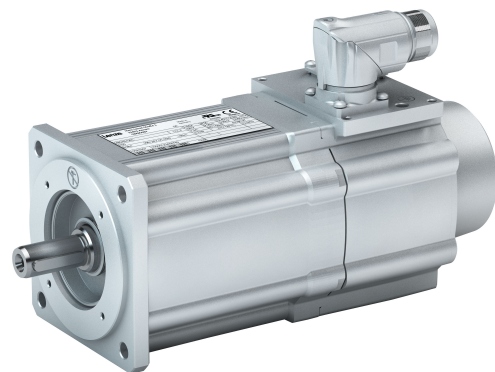

MCS09 synchronous servo motor with One Cable Technology (OCT) in connection with a digital absolute value encoder

Product information

Identification of the products



Identification of the products

Product name: MCS synchronous servo motor

Meaning	Variant					
Product family		MCS				
Size			06 09 12 14 19			
Overall length				C ... P		
Rated speed	rpm x 100				11 ... 60	
Inverter mains connection	3 x 400 V					-
	3 x 230 V					L

Features

The following figure provides an overview of the elements and connections on the product. Their position, size and appearance may vary.

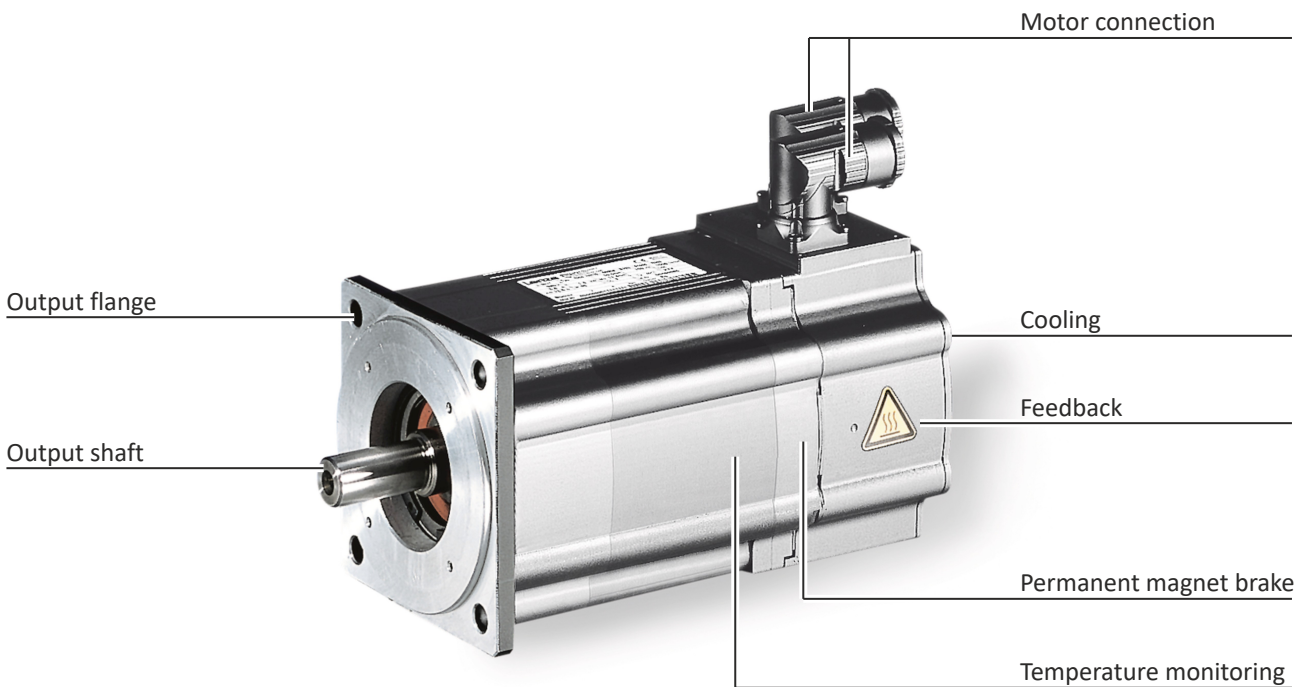



The modular system



Values printed in bold are standard designs. Values that are not printed in bold are potential extensions, some of them including a surcharge.

Motor		MCS06	MCS09	MCS12	MCS14	MCS19
Technical data						
Rated power	kW	0.25 ... 0.75	1.0 ... 1.9	1.1 ... 5.7	1.45 ... 9.1	4.0 ... 15.8
Rated torque	Nm	0.6 ... 1.5	1.8 ... 4.5	4.3 ... 17	7.5 ... 42	21 ... 72
Max. torque	Nm	2.4 ... 6.2	9.5 ... 32	18 ... 56	29 ... 105	86 ... 190
Rated speed	rpm	4050 ... 6000	3750 ... 6000	1350 ... 4050	1050 ... 3600	1200 ... 3000
Color		Primed RAL9005 matt jet black RAL color				
Surface and corrosion protection		OKS-G Different types of OKS				
Output shaft						
Solid shaft with featherkey	mm	11 x 23	14 x 30	19 x 40	24 x 50	28 x 60
Solid shaft without keyway	mm	11 x 23	14 x 30	19 x 40	24 x 50	28 x 60
Shaft material		Steel				
Shaft sealing ring material		FKM				
Shaft seal		Standard Oil-proof				
Design		With flange (B5)				
Output flange	mm	FF75	FF100	FF130	FF165	FF215
Cooling		Self-ventilated IP54 Self-ventilated IP65 - Forced ventilated IP54				
Motor connection		ICN connector ICN hybrid connector for One Cable Technology (OCT) - Terminal box				
Permanent magnet holding brake		Without With				
Standard braking torque	Nm	2.0	6.0	10	18	32
Increased braking torque	Nm	-	10	19	32	80
DC brake voltage	V	24				
Feedback						
Without functional safety		Resolver Absolute value encoder Digital absolute value encoder for One Cable Technology (OCT)				
With functional safety		Resolver Absolute value encoder Digital absolute value encoder for One Cable Technology (OCT)				
Temperature monitoring		PT1000 temperature sensor	PT1000 temperature sensor and 2x PTC thermistor			

Information on project planning

Safety instructions
Basic safety instructions



Information on project planning

Safety instructions

Basic safety instructions

Disregarding the following basic safety instructions and safety information may lead to severe personal injury and damage to property!

- Only use the product as directed.
- Never commission the product in the event of visible damage.
- Never modify the product technically.
- Never commission the product before assembly has been completed.
- Never operate the product without the required covers.
- Connect/disconnect all pluggable connections only in deenergized condition!
- Only remove the product from the installation in the deenergized state.
- The product can – depending on their degree of protection – have live, movable or rotating parts during or after operation. Surfaces can be hot.
- Observe all specifications of the corresponding documentation supplied. This is the condition for safe and trouble-free operation and the achievement of the specified product features.
- The procedural notes and circuit details given in the associated documentation are suggestions and their transferability to the respective application has to be checked. The manufacturer of the product does not take responsibility for the suitability of the process and circuit proposals.
- All work with and on the product may only be carried out by qualified personnel. IEC 60364 and CENELEC HD 384 define the qualifications of these persons:
 - They are familiar with installing, mounting, commissioning, and operating the product.
 - They have the corresponding qualifications for their work.
 - They know and can apply all regulations for the prevention of accidents, directives, and laws applicable at the place of use.

Application as directed

- The product is a professional equipment intended for use by trades, specific professions or industry and not for sale to the general public. IEC 60050 [IEV 161-05-05]
- To prevent personal injury and damage to property, higher-level safety and protection systems must be used!
- All transport locks must be removed.
- Mounted eye bolts on the motor are not suitable for transporting geared motors.
- The product may only be operated under the specified operating conditions and in the specified mounting positions.
- The product may only be operated on the inverter.
- Built-in brakes must not be used as safety brakes.
- The product must not be operated in private areas, in potentially explosive atmospheres and in areas with harmful gases, oils, acids and radiation.



Residual hazards

Even if notes given are taken into consideration and protective measures are implemented, the occurrence of residual risks cannot be fully prevented.

The user must take the residual hazards mentioned into consideration in the risk assessment for his/her machine/system.

If the above is disregarded, this can lead to severe injuries to persons and damage to property!

Product

Observe the warning labels on the product!



Dangerous electrical voltage:

Before working on the product, make sure there is no voltage applied to the power terminals!
After mains disconnection, the power terminals will still carry the hazardous electrical voltage for the time given next to the symbol!



Electrostatic sensitive devices:

Before working on the product, the staff must ensure to be free of electrostatic charge!



High leakage current:

Carry out fixed installation and PE connection in compliance with:
EN 61800-5-1 / EN 60204-1



Hot surface:

Use personal protective equipment or wait until the device has cooled down!

Protection of persons

- The power terminals may carry voltage in the switched-off state or when the motor is stopped.
 - Before working, check whether all power terminals are deenergized.
- Voltages may occur on the drive components (e.g. capacitive, caused by inverter supply).
 - Careful earthing in the marked positions of the components must be carried out.
- There is a risk of burns from hot surfaces.
 - Provide protection against accidental contact.
 - Use personal protective equipment or wait until the device has cooled down.
 - Prevent contact with flammable substances.
- There is a risk of injury due to rotating parts.
 - Before working on the drive system, ensure that the motor is at a standstill.
- There is a risk of accidental start-up or electric shock.

Motor protection

- Installed temperature sensors are no full protection for the machine.
 - If necessary, limit the maximum current. Parameterize the inverter so that it will be switched off after some seconds of operation with $I > I_{rated}$, especially if there is a risk of blocking.
 - Integrated overload protection does not prevent overloading under all conditions.
- The fuses are no motor protection.
 - Use a current-dependent motor protection switch.
 - Use the built-in temperature sensors.
- Too high torques cause a fraction of the motor shaft.
 - Do not exceed the maximum torques according to the technical data on the nameplate.
- Lateral forces on the motor shaft are possible.
 - Align the shafts of motor and driven machine exactly to each other.



Drive dimensioning

In order to carry out an accurate drive dimensioning process, you can use our configuring software, the »Drive Solution Designer«.

With the «Drive Solution Designer», you can design the drive both quickly and to a high quality. The software contains profound and proven expertise with regard to drive applications and mechatronic drive components.

Please get in touch with your Lenze representative.

The dimensioning is suitable for:

- kinematic profiles
- operating modes S1, S2, S3, S6 [138](#)
- simple linear speed profiles, not for S-curves or similar

The following 3 elements are taken into consideration in the dimensioning process:

Drive function

On the basis of the values required for the process that are specified, a drive is selected, for which all operating points are within the speed-torque characteristic curve of the motor.

As a result, a motor with a suitable speed and an inverter with a sufficient maximum current are selected. Further limits (maximum speed, installation height...) are specified in tables.

Mechanical strength

On the basis of the occurring forces and torques, a drive is selected that has a sufficient mechanical strength (endurance strength for the periodically occurring torques and fatigue strength for the sporadically occurring torques).

Thermal dimensioning

For the inverter, the thermal dimensioning process is carried out on the basis of the continuous inverter current or on the basis of the continuous torque from the motor-inverter combination, which can be reached.

The motor is thermally dimensioned on the basis of the mean speed and the effective torque.

The mean speed of the drive should not exceed the values specified.



If dimensioning processes are complex or reach limit loads, please refer to your Lenze representative.



Operation chart

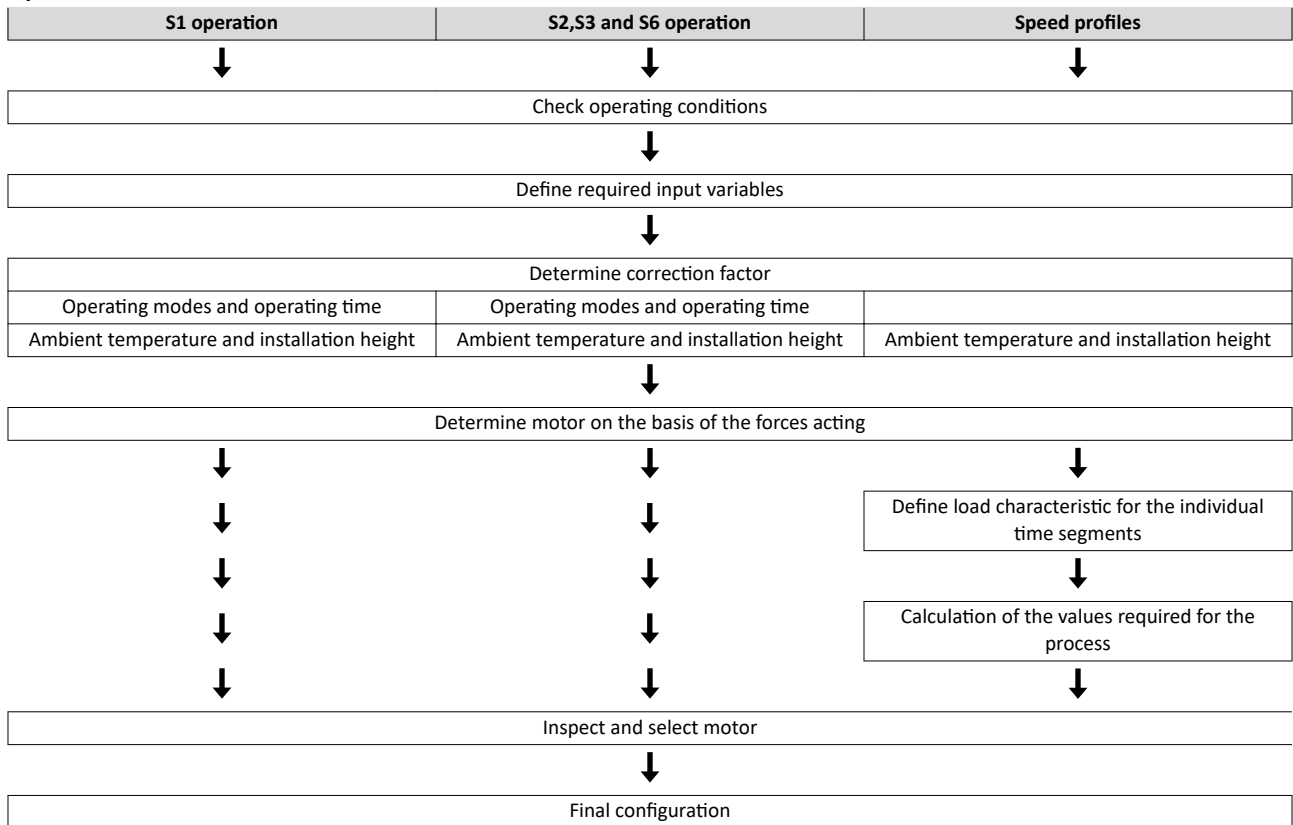

Check operating conditions

Check
Approvals
Conformities
Supply voltage
Degree of protection
Ambient temperature
Surface protection

▶ [Standards and operating conditions](#) 21

▶ [Surface and corrosion protection](#) 17

Define required input variables

Necessary input variables	Note	Symbol	Unit
Mean speed utilisation	Relating to the load speed n_L		%
Ambient temperature		T_U	°C
Site altitude Amsl		H	m
Radial force		F_{rad}	N
Axial force		F_{ax}	N
Transmission element at the output	Gear wheels, sprockets ...		
Effective diameter of the transmission element		d_w	mm
Load torque	Only with S1, S2, S3, and S6 operating modes	M_L	Nm
Load speed	Only with S1, S2, S3, and S6 operating modes	n_L	rpm
Short-time maximum torque	Emergency off, quick stop, occasional high starting duty	$M_{L,max}$	Nm
Runtime with maximum torque		t_L	%



Determine correction factor

Operating modes S1, S2, S3, S6, and operating time							
Operating mode S1		Operating mode S2		Operating mode S3		Operating mode S6	
ED	k_L	ED	k_L	ED	k_L	ED	k_L
%		min		%		%	
100	1.0	10	1.4 - 1.5	15	1.4 - 1.5	15	1.5 - 1.6
		30	1.15 - 1.2	25	1.3 - 1.4	25	1.4 - 1.5
		60	1.07 - 1.1	40	1.15 - 1.2	40	1.3 - 1.4
		90	1.0 - 1.05	60	1.05 - 1.1	60	1.15 - 1.2

► Operating modes of the motor [138](#)

Ambient temperature and installation height				
Ambient temperature	Installation height amsl			
	≤ 1000 m	≤ 2000 m	≤ 3000 m	≤ 4000 m
T_U	Correction factor			
	k_H	k_H	k_H	k_H
≤ 20 °C	1.10	1.01	0.92	0.84
30 °C	1.05	0.97	0.88	0.80
40 °C	1.00	0.92	0.83	0.77
50 °C	0.92	0.85	0.76	0.70
60 °C	0.84	0.78	0.69	0.64

Determine product on the basis of the forces

Transmission element			Gear wheels	Sprockets	Toothed belt pulleys (depending on the preloading)	Narrow V-belt (depending on the preloading)
Additional radial force factor	f_z		≥ 17 teeth = 1.0	≥ 20 teeth = 1.0	With belt tightener= 2.0 - 2.5 Without belt tightener= 2.5 - 3.0	1.5 - 2.0
			< 17 teeth = 1.15	< 20 teeth = 1.25 < 13 teeth = 1.4		
			Calculation		Check	
Radial force	F_{rad}	N	$F_{rad} = 2000 \times \frac{M_{L,max} \times f_z}{dw}$		$F_{rad} \leq F_{rad,max}$	
Axial force	F_{ax}	N			$F_{ax} \leq F_{ax,max}$	

dw Effective diameter of transmission element

► Radial forces and axial forces [23](#)

Operating mode S1

Check and select servo motor/inverter combination			
	Check	Selection	Unit
Output torque	$M_{rated} \geq M_L / (k_L \times k_H)$	M_{rated}	Nm
Output speed	$n_{rated} \geq n_L$	n_{rated}	rpm

► Rated data [25](#)



Operating modes S2, S3, and S6

Check and select servo motor/inverter combination			
	Check	Selection	Unit
Output torque	$M_{rated} \geq M_L / (k_L \times k_H)$	M_{rated}	Nm
Output speed (recommendation)	$n_{rated} \geq n_L$	n_{rated}	rpm
Max. output torque.	$M_{max} \geq M_L$	M_{max}	Nm
Max. output speed	$n_{max} \geq n_L$	n_{max}	rpm
All operating points (●)		n_L	
below the maximum torque characteristic of the servo motor/inverter combination here, $M_{L,max}$ must be considered		M_L	
Thermally effective operating point (○)		n_L	
below the S1 torque characteristic of the servo motor		$M_L / (k_L \times k_H)$	

▶ [Rated data](#) 25

▶ [Torque characteristics](#) 64

Speed profiles

Temporal load characteristic for the individual time segments z							
Total time	Individual time segments	Load speed	Load speed variation	Steady-state load torque	Torque	Acceleration torque	Moment of inertia
t	Δt_z	$n_{L,z}$	$\Delta n_{L,z}$	$M_{L,z}$	M_z	$M_{s,z}$	J_L
s	s	rpm	rpm	Nm	Nm	Nm	kgcm ²

	Calculation	Symbol	Unit
Load cycle duration	$T = \sum \Delta t_z$	T	s

Calculation of the values required for the process			
	Calculation	Symbol	Unit
Torque per time segment	$M_z = M_{L,z} + J_L \frac{2\pi \times \Delta n_{L,z}}{60 \times \Delta t_z}$	M_z	Nm
Maximum torque of the profile	$M_{p,max} = \max(M_z)$	$M_{p,max}$	Nm
Effective torque	$M_{eff} = \sqrt{\frac{1}{T} \sum_z M_z^2 \times \Delta t_z}, T \leq 1\text{min}$	M_{eff}	Nm
Mean speed	$n_m = \overline{n_{L,z}} = \frac{1}{T} \sum_z n_{L,z} \times \Delta t_z$	n_m	rpm
Maximum load speed	$n_{L,max} = \max(n_{L,z})$	$n_{L,max}$	rpm

Information on project planning

Drive dimensioning



Check and select servo motor/inverter combination			
	Check	Preselection	Unit
Output torque	$M_{\text{rated}} > M_{\text{eff}} / k_H$	M_{rated}	Nm
Output speed	$n_{\text{rated}} \geq n_m$	n_{rated}	rpm
Load-matching factor			
for an optimum dynamic performance/ control properties	Requirement $k_j = 0.5 \dots 10$ Optimum $k_j = 1$	$k_j = J_L / (J_M + J_B)$	
Checking the motor torques			
Acceleration torque	$M_{S,z} = M_z + (J_M + J_B) \times \frac{2\pi \times \Delta n_{L,z}}{60 \times \Delta t_z}$	$M_{S,z}$	Nm
Effective torque	$M_{S,\text{eff}} = \sqrt{\frac{1}{T} \sum_z M_{S,z}^2 \times \Delta t_z}$	$M_{S,\text{eff}}$	
All operating points (●)		$n_{L,z}$	
below the maximum torque characteristic of the servo motor/ inverter combination here, $M_{L,\text{max}}$ must be considered		$M_{S,z}$	
Thermally effective operating point (○)		n_m	
below the S1 torque characteristic of the servo motor		$M_{S,\text{eff}} / k_H$	

▶ [Rated data](#) 25

▶ [Torque characteristics](#) 64



Final configuration

	Check
Connection dimensions	Output shaft Output flange
Product extensions	Motor connection (connector/terminal box) Brake Feedback Blower

More information about the final configuration:

▶ [The modular system](#) 9

▶ [Product extensions](#) 111

Surface and corrosion protection

Depending on the ambient conditions, the surface and corrosion protection system (called OKS) offers solutions for optimum protection.

Various surface coatings ensure that the motors operate reliably at high air humidity, in outdoor installation or in the presence of atmospheric impurities. Any color from the "RAL Classic" collection can be chosen for the top coat.

Surface and corrosion protection	Applications	Type
OKS-G (primed)	<ul style="list-style-type: none"> Dependent on subsequent top coat applied 	Standard
OKS-S (small)	<ul style="list-style-type: none"> Standard applications Internal installation in heated buildings Air humidity up to 90 % 	Optional
OKS-M (medium)	<ul style="list-style-type: none"> Internal installation in non-heated buildings Covered, protected external installation Air humidity up to 95 % 	
OKS-L (large)	<ul style="list-style-type: none"> External installation Air humidity above 95 % Chemical industrial plants Food industry 	

Surface and corrosion protection	Corrosivity category	Surface coating	Color	Coating thickness
	DIN EN ISO 12944-2	Design		
OKS-G (primed)		<ul style="list-style-type: none"> 2K PUR priming coat 	<ul style="list-style-type: none"> RAL 9005 matt jet black 	30 ... 40 µm
OKS-S (small)	Comparable to C1	<ul style="list-style-type: none"> 2K-PUR top coat 	<ul style="list-style-type: none"> According to RAL Classic 	50 ... 70 µm
OKS-M (medium)	Comparable to C2	<ul style="list-style-type: none"> 2K PUR priming coat 		80 ... 110 µm
OKS-L (large)	Comparable to C3	<ul style="list-style-type: none"> 2K-PUR top coat 		110 ... 150 µm



Mechanical installation

Important notes

- Install the product according to the information in the chapter "Standards and operating conditions".
 - ▶ [Standards and operating conditions](#) 21
- The technical data and the data regarding the supply conditions can be found on the nameplate and in this documentation.
- Ambient media – especially chemically aggressive ones – may damage shaft sealing rings, lacquers and plastics.
- Lenze offers special surface and corrosion protection in this case.

NOTICE

Bearing damage caused by unbalance!

Shafts with keyway are balanced with a half featherkey!

- ▶ Balance transmission elements with a half featherkey!
-

Transport

- Ensure appropriate handling.
- Make sure that all component parts are securely mounted. Secure or remove loose component parts.
- Only use safely fixed transport aids (e.g., eye bolts or support plates).
- Do not damage any components during transport.
- Avoid electrostatic discharges on electronic components and contacts.
- Avoid impacts.
- Check the carrying capacity of the hoists and load handling devices. The weights can be found in the shipping documents.
- Secure the load against tipping and falling down.
- Standing beneath suspended loads is prohibited.

Installation

- The mounting surfaces must be plane, torsionally rigid and free from vibrations.
- The mounting areas must be suited to absorb the forces and torques generated during operation.
- Ensure an unhindered ventilation.
- For versions with a fan, keep a minimum distance of 10 % from the outside diameter of the fan cover in intake direction.



Electrical installation

Important notes

DANGER!

Risk of injury and risk of burns from dangerous voltage

Power terminals may also carry voltage in the switched-off state or when the motor is stopped and may cause life-threatening cardiac arrhythmia and serious burns.

- ▶ Disconnect the product from the mains.
- ▶ Check that the power terminals are deenergized before starting work.

-
- When working on energized products, comply with the applicable national accident prevention regulations.
 - The electrical installation must be carried out according to the appropriate regulations (e.g. cable cross-sections, fuses, PE connection).
 - The manufacturer of the system or machine is responsible for adherence to the limits required in connection with EMC legislation.

Operation on an external inverter

A max. pulse voltage amplitude of $U_{pk} = 1560 \text{ V}$ at the motor terminals must not be exceeded. Here, the minimum pulse rise time must be $t_R = 0.1 \mu\text{s}$.

If it cannot be ruled out that the permissible voltage peaks will be exceeded or that the minimum pulse rise time will not be reached, the following measures must be initiated:

- Reduction of the DC-bus voltage (threshold for brake chopper voltage)
- Use of filters, chokes
- Use of special motor cables

Preparation



The notes for the electrical connection can be found in the enclosed mounting instructions.

EMC-compliant wiring



The EMC-compliant wiring is described in detail in the documentation of the Lenze inverters.

Technical data

Notes regarding the given data



Technical data

Notes regarding the given data

The power values, torques and speeds specified in the configuration are rounded values and apply to:

- ambient temperature $T_U = 40\text{ °C}$ for motors (in compliance with EN 60034)
- Site altitude $\leq 1000\text{ m}$ above mean sea level

The selection tables specify the inverter/ motor combination with the achievable torques.

The rated data applies to the S1 operating mode S1 (in accordance with EN 60034-1) and the operation on a servo inverter with a switching frequency of at least 4 kHz.

NOTICE

In case of other operating conditions, the achievable values can differ for those mentioned.

► In case of extreme operating conditions, please get in touch with your Lenze representative.

Cooling effect of mounting flange

Mounting on a thermally conducting / insulating plate or machine chassis has an influence on heating up the motor, particularly when using naturally ventilated motors.

The motor rating data specified in the catalogue applies when mounting on a steel plate with free convection with the following dimensions:

Motor	Width	Height
	mm	mm
MCS06...	270	270
MCS09...	330	330
MCS12 ... 19	450	450



Standards and operating conditions

Conformities and approvals

More information and certificates of approval can be found under

[MCS synchronous servo motors \(Lenze.com\)](https://www.lenze.com)

Europe					
Country	Conformity/ approval	Law/standard	Description	Special feature	Product representation
European Union	CE	2006/42/EC	Machinery Directive	Only for safety-relevant components	CE mark
		2014/35/EU	Low-Voltage Directive		
		2014/30/EU	EMC Directive		
		2011/65/EU	RoHS		
Eurasian Economic Union (EAC)	EAC	TP TC 004/2011	Eurasian conformity: safety of low voltage equipment	-	EAC mark
		TP TC 020/2011	Eurasian conformity: electromagnetic compatibility		
Great Britain	UKCA	S.I. 2008/1597	The Supply of Machinery (Safety) Regulations 2008	Only for safety-relevant components	UKCA mark
		S.I. 2016/1091	The Electromagnetic Compatibility Regulations 2016		
		S.I. 2016/1101	The Electrical Equipment (Safety) Regulations 2016		
		S.I. 2012/3032	The Restriction of the Use of Certain Hazardous Substances in Electrical and Electronic Equipment Regulations 2012		

America					
Country	Conformity/ approval	Law/standard	Description	Special feature	Product representation
Canada	CSA	CSA 22.1 No. 100	CSA Standard for Motors and Generators	-	cURus mark
USA	UL	UL 1004-1	UL Standard for Rotating Electrical Machines		

Asia					
Country	Conformity/ approval	Law/standard	Description	Special feature	Product representation
China	-	GB 30253	Minimum allowable values of energy efficiency and energy efficiency grades for permanent magnet synchronous motors	-	CEL mark
		GB/T 26572	Requirements on concentration limits for certain restricted substances in electrical and electronic products		EFUP mark

Protection of persons and device protection

Degree of protection			
-	EN IEC 60529, EN IEC 60034-5	IP54	Self-ventilated: MCS06 ... MCS19
		IP65	Forced ventilated: MCS12 ... MCS19
Temperature class			
-	EN IEC 60034-1	F (155 °C)	Insulation system
Permissible voltage			
-	IEC 60034-18-41	IVIC C	At 500 V
	IEC/TS 60034-25:2007	Limit curve A	Of the pulse voltage

Technical data

Standards and operating conditions
EMC data



EMC data

Noise emission		
-	EN IEC 60034-1	A final overall assessment of the drive system is indispensable
Noise immunity		
-	EN IEC 60034-1	A final overall assessment of the drive system is indispensable

Environmental conditions

Climate			
Storage	EN 60721-3-1:1997	1K3 (-20 ... +40 °C)	>3 months
		1K3 (-20 ... +60 °C)	<3 months
Transport	EN 60721-3-2:1997	2K3 (-20 ... +70 °C)	
Operation	EN 60721-3-3:1995 + A2:1997	3K3 (-10 ... +40 °C)	Operation with brake
		3K3 (-15 ... +40 °C)	Operation without brake, forced ventilated
		3K3 (-20 ... +40 °C)	Operation without brake, self-ventilated
Site altitude			
0 ... 1000 m amsl	-	Without current derating	
1000 ... 4000 m amsl	-	Reduce rated output current by 5 %/1000 m	
Air humidity			
-	-	Average relative humidity 85 %	Without condensation
Vibration resistance			
Operation	EN 60721-3-3:1995 + A2:1997	3M5	Only in operation with feedback AM20-8V-D or AM20-8V-D2
		3M6	
Vibration severity			
-	EN IEC 60034-14	A	
Vibration velocity			
Free suspension	-	1.6 mm/s	
Radial runout, axial runout, concentricity			
-	EN 50347 / IEC 60072-1	Normal Class	



Radial forces and axial forces



The values of the bearing service life L_{10h} refer to an average motor speed of 4000 rpm. Depending on the ambient temperatures, they are additionally limited by the grease lifetime.

► Rated data [25](#)

Application of forces

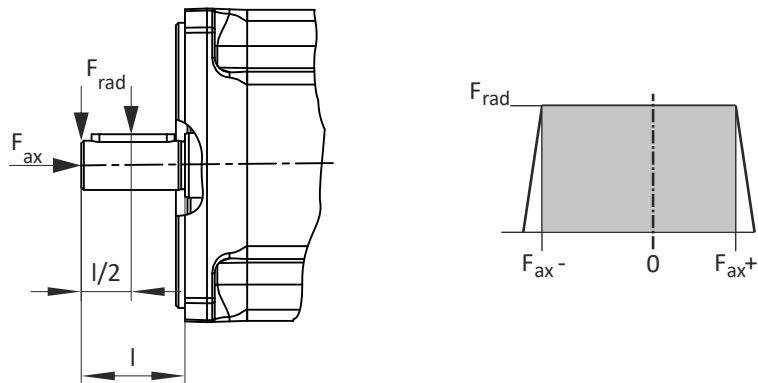

Application of force at $l/2$

Motor			MCS 06	MCS 09	MCS 12	MCS 14	MCS 19
Bearing service life 5000							
Radial force	F_{rad}	rated	740	1040	1030	1830	3840
Min. axial force	$F_{ax,-}$	rated	-260	-700	-880	-1150	-1550
Max. axial force	$F_{Fax,+}$	rated	140	470	560	720	950
Bearing service life 10000							
Radial force	F_{rad}	rated	590	830	820	1450	3050
Min. axial force	$F_{ax,-}$	rated	-210	-550	-690	-900	-1210
Max. axial force	$F_{Fax,+}$	rated	80	310	370	470	620
Bearing service life 20000							
Radial force	F_{rad}	rated	470	660	650	1150	2430
Min. axial force	$F_{ax,-}$	rated	-170	-440	-550	-720	-960
Max. axial force	$F_{Fax,+}$	rated	40	200	230	290	360
Bearing service life 30000							
Radial force	F_{rad}	rated	410	580	570	1010	2120
Min. axial force	$F_{ax,-}$	rated	-150	-380	-490	-640	-840
Max. axial force	$F_{Fax,+}$	rated	30	150	160	200	250
Bearing service life 50000							
Radial force	F_{rad}	rated	340	490	480	850	1790
Min. axial force	$F_{ax,-}$	rated	-140	-330	-420	-550	-730
Max. axial force	$F_{Fax,+}$	rated	10	90	100	120	130

Technical data

Radial forces and axial forces



Application of force at I

Motor			MCS 06	MCS 09	MCS 12	MCS 14	MCS 19
Bearing service life 5000							
Radial force	F_{rad}	rated	630	900	890	1590	3330
Min. axial force	$F_{ax,-}$	rated	-210	-630	-820	-1040	-1320
Max. axial force	$F_{Fax,+}$	rated	90	400	490	610	730
Bearing service life 10000							
Radial force	F_{rad}	rated	500	710	710	1260	2650
Min. axial force	$F_{ax,-}$	rated	-170	-500	-640	-820	-1040
Max. axial force	$F_{Fax,+}$	rated	50	260	320	390	450
Bearing service life 20000							
Radial force	F_{rad}	rated	400	570	560	1000	2100
Min. axial force	$F_{ax,-}$	rated	-140	-400	-520	-660	-830
Max. axial force	$F_{Fax,+}$	rated	20	160	190	230	240
Bearing service life 30000							
Radial force	F_{rad}	rated	350	500	490	880	1840
Min. axial force	$F_{ax,-}$	rated	-130	-350	-460	-580	-740
Max. axial force	$F_{Fax,+}$	rated	0	120	130	150	140
Bearing service life 50000							
Radial force	F_{rad}	rated	290	420	420	740	1550
Min. axial force	$F_{ax,-}$	rated	-120	-300	-400	-510	-640
Max. axial force	$F_{Fax,+}$	rated	-10	70	70	70	40



Technical data

Rated data

Inverter mains connection 400 V, Self-ventilated motors

Rated data

Inverter mains connection 400 V, Self-ventilated motors

Motor			MCS 06C60-	MCS 06C41-	MCS 06F60-	MCS 06F41-	MCS 06I60-	MCS 06I41-
Standstill torque	M_0	Nm	0.800	0.800	1.50	1.50	2.00	2.00
Rated torque	M_{rated}	Nm	0.500	0.600	0.900	1.20	1.20	1.50
Max. torque	M_{max}	Nm	2.40	2.40	4.40	4.40	6.20	6.20
Rated speed	n_{rated}	rpm	6000	4050	6000	4050	6000	4050
Max. speed	n_{max}	rpm	8000	8000	8000	8000	8000	8000
Rated power	P_{rated}	kW	0.31	0.25	0.57	0.51	0.75	0.64
Standstill current	I_0	A	2.50	1.30	2.90	1.50	3.40	1.70
Rated current	I_{rated}	A	2.40	1.30	2.50	1.50	2.90	1.60
Max. current	I_{max}	A	10.8	5.40	10.5	5.30	11.8	5.90
Rated voltage	V_{rated}	V	135	225	180	320	190	325
Rated frequency	f_{rated}	Hz	400	270	400	270	400	270
Moment of inertia	J	kgcm ²	0.140	0.140	0.220	0.220	0.300	0.300
Efficiency	η		0.7	0.65	0.81	0.77	0.84	0.81
Torque constant	$K_{t0.150}$ °C	Nm/A	0.320	0.615	0.517	1.00	0.588	1.18
Voltage constant	$K_{E_{LL150}}$ °C	V/ (1000/ min)	17.89	35.79	29.33	58.76	35.88	71.77
Stator terminal resistance	R_{UV20} °C	Ω	6.8	27	5.4	21.8	4.6	18.8
Stator terminal resistance	R_{UV150} °C	Ω	10.248	40.689	8.138	32.853	6.932	28.332
Stator inductance	L	mH	12.8	51.0	15.9	63.5	15.1	60.2
Weight	m	kg	2.30	2.30	2.70	2.70	3.40	3.40

Technical data

Rated data

Inverter mains connection 400 V, Self-ventilated motors



Motor			MCS 09D60-	MCS 09D41-	MCS 09F60-	MCS 09H60-	MCS 09F38-	MCS 09L51-
Standstill torque	M_0	Nm	3.30	3.30	4.20	5.50	4.20	7.50
Rated torque	M_{rated}	Nm	1.80	2.30	2.40	3.00	3.10	3.60
Max. torque	M_{max}	Nm	9.50	9.50	15.0	20.0	15.0	32.0
Rated speed	n_{rated}	rpm	6000	4050	6000	6000	3750	5100
Max. speed	n_{max}	rpm	7000	7000	7000	7000	7000	7000
Rated power	P_{rated}	kW	1.1	1	1.5	1.9	1.2	1.9
Standstill current	I_0	A	5.30	2.60	6.00	8.50	3.00	12.4
Rated current	I_{rated}	A	3.80	2.30	4.50	6.00	2.50	6.90
Max. current	I_{max}	A	20.0	10.0	30.0	40.0	15.0	64.0
Rated voltage	V_{rated}	V	210	320	230	190	330	180
Rated frequency	f_{rated}	Hz	400	270	400	400	250	340
Moment of inertia	J	kgcm ²	1.10	1.10	1.50	1.90	1.50	2.80
Efficiency	η		0.87	0.82	0.9	0.91	0.9	0.91
Torque constant	$K_{t_{0.150}}$ °C	Nm/A	0.623	1.27	0.700	0.647	1.40	0.605
Voltage constant	$K_{E_{LL150}}$ °C	V/ (1000/ min)	34.81	69.62	39.01	36.96	78.02	35.1
Stator terminal resistance	R_{UV20} °C	Ω	1.8	7	1.2	0.8	5.2	0.44
Stator terminal resistance	R_{UV150} °C	Ω	2.713	10.549	1.808	1.206	7.836	0.663
Stator inductance	L	mH	6.30	25.1	6.15	4.02	24.6	2.50
Weight	m	kg	4.80	4.80	5.70	6.60	5.70	8.40



Technical data

Rated data

Inverter mains connection 400 V, Self-ventilated motors

Motor			MCS 09H41-	MCS 09L41-	MCS 12D41-	MCS 12D20-	MCS 12H35-	MCS 12H15-
Standstill torque	M_0	Nm	5.50	7.50	6.40	6.40	11.4	11.4
Rated torque	M_{rated}	Nm	3.80	4.50	4.30	5.50	7.50	10.0
Max. torque	M_{max}	Nm	20.0	32.0	18.0	18.0	29.0	29.0
Rated speed	n_{rated}	rpm	4050	4050	4050	1950	3525	1500
Max. speed	n_{max}	rpm	7000	7000	6000	6000	6000	6000
Rated power	P_{rated}	kW	1.6	1.9	1.8	1.1	2.8	1.6
Standstill current	I_0	A	4.30	6.20	5.50	2.70	8.20	4.10
Rated current	I_{rated}	A	3.40	4.20	4.50	2.60	5.70	3.80
Max. current	I_{max}	A	20.0	32.0	20.0	10.0	24.0	12.0
Rated voltage	V_{rated}	V	300	295	310	345	325	300
Rated frequency	f_{rated}	Hz	270	270	270	130	235	100
Moment of inertia	J	kgcm ²	1.90	2.80	4.00	4.00	7.30	7.30
Efficiency	η		0.91	0.91	0.84	0.85	0.91	0.88
Torque constant	$K_{t0\ 150}$ °C	Nm/A	1.28	1.21	1.16	2.37	1.39	2.78
Voltage constant	$K_{E_{LL\ 150}}$ °C	V/ (1000/ min)	74.02	70.1	67.07	133.95	84.58	169.15
Stator terminal resistance	$R_{UV\ 20}$ °C	Ω	3.2	1.8	2.2	8.7	1.4	5.8
Stator terminal resistance	$R_{UV\ 150}$ °C	Ω	4.822	2.713	3.315	13.111	2.11	8.741
Stator inductance	L	mH	16.1	9.90	13.0	52.2	10.5	42.1
Weight	m	kg	6.60	8.40	7	7	10.1	10.1

Technical data

Rated data

Inverter mains connection 400 V, Self-ventilated motors



Motor			MCS 12L41-	MCS 12L20-	MCS 14D36-	MCS 14D15-	MCS 14H32-	MCS 14H15-
Standstill torque	M_0	Nm	15.0	15.0	11.0	11.0	21.0	21.0
Rated torque	M_{rated}	Nm	11.0	13.5	7.50	9.20	14.0	16.0
Max. torque	M_{max}	Nm	56.0	56.0	29.0	29.0	55.0	55.0
Rated speed	n_{rated}	rpm	4050	1950	3600	1500	3225	1500
Max. speed	n_{max}	rpm	6000	6000	6000	6000	6000	6000
Rated power	P_{rated}	kW	4.7	2.8	2.8	1.45	4.7	2.5
Standstill current	I_0	A	12.4	6.20	10.0	5.00	16.9	8.50
Rated current	I_{rated}	A	10.2	5.90	7.50	4.50	11.9	6.60
Max. current	I_{max}	A	56.0	28.0	33.0	16.5	51.5	25.8
Rated voltage	V_{rated}	V	300	330	295	305	295	325
Rated frequency	f_{rated}	Hz	270	130	240	100	215	100
Moment of inertia	J	kgcm ²	10.6	10.6	8.10	8.10	14.2	14.2
Efficiency	η		0.91	0.9	0.92	0.88	0.93	0.92
Torque constant	$K_{t_{0.150}}$ °C	Nm/A	1.21	2.42	1.10	2.20	1.24	2.47
Voltage constant	$K_{E_{LL150}}$ °C	V/ (1000/ min)	72.94	145.69	62.77	126.13	74.6	149.6
Stator terminal resistance	R_{UV20} °C	Ω	0.6	2.2	1	4	0.52	2.08
Stator terminal resistance	R_{UV150} °C	Ω	0.904	3.315	1.507	6.028	0.784	3.135
Stator inductance	L	mH	5.45	21.8	12.5	49.8	8.53	34.1
Weight	m	kg	13.2	13.2	11.4	11.4	16.2	16.2



Technical data

Rated data

Inverter mains connection 400 V, Self-ventilated motors

Motor			MCS 14L32-	MCS 14P32-	MCS 14L15-	MCS 14P14-	MCS 19F30-	MCS 19F14-
Standstill torque	M_0	Nm	28.0	37.0	28.0	37.0	32.0	32.0
Rated torque	M_{rated}	Nm	17.2	21.0	23.0	30.0	21.0	27.0
Max. torque	M_{max}	Nm	77.0	105	77.0	105	86.0	86.0
Rated speed	n_{rated}	rpm	3225	3225	1500	1350	3000	1425
Max. speed	n_{max}	rpm	6000	6000	6000	6000	4000	4000
Rated power	P_{rated}	kW	5.8	7.1	3.6	4.2	6.6	4
Standstill current	I_0	A	24.0	24.3	12.0	12.2	19.8	9.90
Rated current	I_{rated}	A	15.0	15.6	9.70	10.8	14.0	8.60
Max. current	I_{max}	A	74.5	92.0	37.3	46.0	62.5	31.3
Rated voltage	V_{rated}	V	275	315	315	340	300	335
Rated frequency	f_{rated}	Hz	215	215	100	90	200	95
Moment of inertia	J	kgcm ²	23.4	34.7	23.4	34.7	65.0	65.0
Efficiency	η		0.93	0.93	0.9	0.9	0.93	0.92
Torque constant	$K_{t_{0.150}}$ °C	Nm/A	1.17	1.52	2.33	3.03	1.62	3.23
Voltage constant	$K_{E_{LL150}}$ °C	V/ (1000/ min)	74.5	87.41	148.62	175.02	95.04	190.66
Stator terminal resistance	R_{UV20} °C	Ω	0.4	0.28	1.2	1.2	0.32	1.3
Stator terminal resistance	R_{UV150} °C	Ω	0.603	0.422	1.808	1.808	0.482	1.959
Stator inductance	L	mH	5.51	5.99	22.0	23.9	5.20	20.8
Weight	m	kg	20.8	25.6	20.8	25.6	24	24

Technical data

Rated data

Inverter mains connection 400 V, Self-ventilated motors



Motor			MCS 19J30-	MCS 19P30-	MCS 19J14-	MCS 19P14-
Standstill torque	M_0	Nm	51.0	64.0	51.0	64.0
Rated torque	M_{rated}	Nm	29.0	32.0	40.0	51.0
Max. torque	M_{max}	Nm	129	190	129	190
Rated speed	n_{rated}	rpm	3000	3000	1425	1350
Max. speed	n_{max}	rpm	4000	4000	4000	4000
Rated power	P_{rated}	kW	9.1	10	6	7.2
Standstill current	I_0	A	30.5	34.9	15.2	17.5
Rated current	I_{rated}	A	18.5	19.0	12.3	14.3
Max. current	I_{max}	A	89.6	120	44.8	60.0
Rated voltage	V_{rated}	V	300	320	330	330
Rated frequency	f_{rated}	Hz	200	200	95	90
Moment of inertia	J	kgcm ²	105	160	105	160
Efficiency	η		0.93	0.93	0.92	0.92
Torque constant	$K_{t_{0.150}}$ °C	Nm/A	1.67	1.83	3.36	3.66
Voltage constant	$K_{E_{LL150}}$ °C	V/ (1000/ min)	97.29	105.6	194.57	211.19
Stator terminal resistance	R_{UV20} °C	Ω	0.16	0.14	0.66	0.54
Stator terminal resistance	R_{UV150} °C	Ω	0.241	0.211	0.995	0.814
Stator inductance	L	mH	3.20	2.40	12.8	9.60
Weight	m	kg	31	41	31	41



Technical data

Rated data

Inverter mains connection 400 V, Forced ventilated motors

Inverter mains connection 400 V, Forced ventilated motors

Motor			MCS 12H34-	MCS 12H14-	MCS 12L39-	MCS 12L17-	MCS 12D35-	MCS 12D17-
Standstill torque	M_0	Nm	12.8	12.8	19.0	19.0	7.50	7.50
Rated torque	M_{rated}	Nm	10.5	12.0	14.0	17.0	6.00	7.00
Max. torque	M_{max}	Nm	29.0	29.0	56.4	56.4	17.7	17.7
Rated speed	n_{rated}	rpm	3375	1350	3900	1650	3525	1650
Max. speed	n_{max}	rpm	6000	6000	6000	6000	6000	6000
Rated power	P_{rated}	kW	3.7	1.7	5.7	2.9	2.2	1.2
Standstill current	I_0	A	8.50	4.60	14.4	7.20	6.40	3.20
Rated current	I_{rated}	A	7.50	4.10	11.7	6.70	5.60	3.00
Max. current	I_{max}	A	24.0	12.0	57.0	28.0	20.0	10.0
Rated voltage	V_{rated}	V	320	310	295	300	300	330
Rated frequency	f_{rated}	Hz	225	90	260	110	235	110
Moment of inertia	J	kgcm ²	7.30	7.30	10.6	10.6	4.00	4.00
Efficiency	η		0.86	0.8	0.94	0.9	0.85	0.75
Torque constant	$K_{t0\ 150}$	Nm/A °C	1.51	2.78	1.32	2.64	1.17	2.34
Voltage constant	$K_{E_{LL\ 150}}$	V/ (1000/ min) °C	84.58	169.15	72.94	145.69	67.07	133.95
Stator terminal resistance	$R_{UV\ 20}$	Ω °C	1.4	5.8	0.6	2.2	4.4	17.4
Stator terminal resistance	$R_{UV\ 150}$	Ω °C	2.11	8.741	0.904	3.315	6.631	26.222
Stator inductance	L	mH	10.5	42.1	5.45	21.8	13.0	52.2
Weight	m	kg	12.2	12.2	15.3	15.3	9.1	9.1

Technical data

Rated data

Inverter mains connection 400 V, Forced ventilated motors



Motor			MCS 14D30-	MCS 14D14-	MCS 14H28-	MCS 14H12-	MCS 14L30-	MCS 14L14-
Standstill torque	M_0	Nm	12.5	12.5	25.5	25.5	34.5	34.5
Rated torque	M_{rated}	Nm	10.5	12.0	20.5	23.5	25.5	30.5
Max. torque	M_{max}	Nm	29.0	29.0	54.8	54.8	77.1	77.1
Rated speed	n_{rated}	rpm	3000	1350	2775	1200	3000	1350
Max. speed	n_{max}	rpm	6000	6000	6000	6000	6000	6000
Rated power	P_{rated}	kW	3.3	1.7	6	3	8	4.3
Standstill current	I_0	A	11.4	5.70	18.4	9.30	26.7	13.4
Rated current	I_{rated}	A	9.70	5.40	15.0	8.30	20.8	11.8
Max. current	I_{max}	A	33.0	16.5	51.5	25.8	74.5	37.3
Rated voltage	V_{rated}	V	325	345	325	335	310	335
Rated frequency	f_{rated}	Hz	200	90	185	80	200	90
Moment of inertia	J	kgcm ²	8.10	8.10	14.2	14.2	23.4	23.4
Efficiency	η		0.92	0.84	0.93	0.87	0.92	0.88
Torque constant	$K_{t_{0\ 150}}$ °C	Nm/A	1.10	2.19	1.39	2.74	1.29	2.57
Voltage constant	$K_{E_{LL\ 150}}$ °C	V/ (1000/ min)	62.77	126.13	74.6	149.6	74.5	148.62
Stator terminal resistance	$R_{UV\ 20}$ °C	Ω	1	4	0.52	2.08	0.4	1.2
Stator terminal resistance	$R_{UV\ 150}$ °C	Ω	1.507	6.028	0.784	3.135	0.603	1.808
Stator inductance	L	mH	12.5	49.8	8.53	34.1	5.51	22.0
Weight	m	kg	15.2	15.2	20.2	20.2	24.7	24.7



Technical data

Rated data

Inverter mains connection 400 V, Forced ventilated motors

Motor			MCS 14P26-	MCS 14P11-	MCS 19F29-	MCS 19F12-	MCS 19J29-	MCS 19P29-
Standstill torque	M_0	Nm	43.5	43.5	41.5	41.5	70.5	86.0
Rated torque	M_{rated}	Nm	33.0	42.0	32.5	38.0	50.5	53.0
Max. torque	M_{max}	Nm	105	105	86.0	86.0	129	190
Rated speed	n_{rated}	rpm	2625	1050	2850	1200	2850	2850
Max. speed	n_{max}	rpm	6000	6000	4000	4000	4000	4000
Rated power	P_{rated}	kW	9.1	4.6	9.7	4.8	15.1	15.8
Standstill current	I_0	A	28.3	14.1	24.5	12.2	40.6	44.7
Rated current	I_{rated}	A	21.9	13.4	20.1	11.3	31.0	29.5
Max. current	I_{max}	A	92.0	46.0	62.5	31.3	89.6	120
Rated voltage	V_{rated}	V	325	330	320	320	315	315
Rated frequency	f_{rated}	Hz	175	70	190	80	190	190
Moment of inertia	J	kgcm ²	34.7	34.7	65.0	65.0	105	160
Efficiency	η		0.92	0.86	0.95	0.9	0.93	0.93
Torque constant	$K_{t_{0.150}}$ °C	Nm/A	1.54	3.09	1.69	3.40	1.74	1.92
Voltage constant	$K_{E_{LL150}}$ °C	V/ (1000/ min)	87.41	175.02	95.04	190.66	97.29	105.6
Stator terminal resistance	R_{UV20} °C	Ω	0.28	1.2	0.32	1.3	0.16	0.14
Stator terminal resistance	R_{UV150} °C	Ω	0.422	1.808	0.482	1.959	0.241	0.211
Stator inductance	L	mH	5.99	23.9	5.20	20.8	3.20	2.40
Weight	m	kg	29.7	29.7	30	30	37	47

Technical data

Rated data

Inverter mains connection 400 V, Forced ventilated motors



Motor			MCS 19J12-	MCS 19P12-
Standstill torque	M_0	Nm	70.5	86.0
Rated torque	M_{rated}	Nm	62.5	72.0
Max. torque	M_{max}	Nm	129	190
Rated speed	n_{rated}	rpm	1200	1200
Max. speed	n_{max}	rpm	4000	4000
Rated power	P_{rated}	kW	7.9	9
Standstill current	I_0	A	20.3	22.4
Rated current	I_{rated}	A	18.3	21.3
Max. current	I_{max}	A	44.8	60.0
Rated voltage	V_{rated}	V	320	310
Rated frequency	f_{rated}	Hz	80	80
Moment of inertia	J	kgcm ²	105	160
Efficiency	η		0.89	0.9
Torque constant	$K_{t_{0.150}}$ °C	Nm/A	3.47	3.84
Voltage constant	$K_{E_{LL150}}$ °C	V/ (1000/ min)	194.57	211.19
Stator terminal resistance	R_{UV20} °C	Ω	0.66	0.54
Stator terminal resistance	R_{UV150} °C	Ω	0.995	0.814
Stator inductance	L	mH	12.8	9.60
Weight	m	kg	37	47



Technical data

Rated data

Inverter mains connection 230 V, Self-ventilated motors

Inverter mains connection 230 V, Self-ventilated motors

Motor			MCS 06C60L	MCS 06C41L	MCS 06F60L	MCS 06F41L	MCS 06I60L	MCS 06I41L
Standstill torque	M_0	Nm	0.800	0.800	1.50	1.50	2.00	2.00
Rated torque	M_{rated}	Nm	0.500	0.600	0.900	1.20	1.20	1.50
Max. torque	M_{max}	Nm	2.40	2.40	4.40	4.40	6.20	6.20
Rated speed	n_{rated}	rpm	6000	4050	6000	4050	6000	4050
Max. speed	n_{max}	rpm	8000	8000	8000	8000	8000	8000
Rated power	P_{rated}	kW	0.31	0.25	0.57	0.51	0.75	0.64
Standstill current	I_0	A	4.30	2.50	3.80	2.90	4.20	3.10
Rated current	I_{rated}	A	4.00	2.50	3.40	2.90	3.60	2.90
Max. current	I_{max}	A	18.5	10.8	16.5	10.5	16.0	11.8
Rated voltage	V_{rated}	V	85	125	125	165	150	175
Rated frequency	f_{rated}	Hz	400	270	400	270	400	270
Moment of inertia	J	kgcm ²	0.140	0.140	0.220	0.220	0.300	0.300
Efficiency	η		0.7	0.65	0.82	0.81	0.84	0.81
Torque constant	$K_{t0\ 150}$ °C	Nm/A	0.186	0.320	0.395	0.517	0.476	0.645
Voltage constant	$K_{E\ LL\ 150}$ °C	V/ (1000/ min)	12.22	21.02	21.71	33.73	27.87	37.15
Stator terminal resistance	$R_{UV\ 20}$ °C	Ω	2.148	5.926	2.222	5.481	2.519	4.593
Stator terminal resistance	$R_{UV\ 150}$ °C	Ω	3.237	8.93	3.349	8.26	3.796	6.922
Stator inductance	L	mH	4.30	12.8	6.90	15.9	9.30	15.1
Weight	m	kg	2.30	2.30	2.70	2.70	3.40	3.40

Technical data

Rated data

Inverter mains connection 230 V, Self-ventilated motors



Motor			MCS 09D60L	MCS 09D41L	MCS 09F60L	MCS 09H60L	MCS 09F38L	MCS 09H41L
Standstill torque	M_0	Nm	3.30	3.30	4.20	5.50	4.20	5.50
Rated torque	M_{rated}	Nm	1.80	2.30	2.40	3.00	3.10	3.80
Max. torque	M_{max}	Nm	9.50	9.50	15.0	20.0	15.0	20.0
Rated speed	n_{rated}	rpm	6000	4050	6000	6000	3750	4050
Max. speed	n_{max}	rpm	7000	7000	7000	7000	7000	7000
Rated power	P_{rated}	kW	1.1	1	1.5	1.9	1.2	1.6
Standstill current	I_0	A	10.3	5.30	10.5	12.0	6.00	8.50
Rated current	I_{rated}	A	7.00	4.60	7.90	8.00	5.00	6.80
Max. current	I_{max}	A	39.0	20.0	52.5	57.0	30.0	40.0
Rated voltage	V_{rated}	V	110	165	125	145	160	160
Rated frequency	f_{rated}	Hz	400	270	400	400	250	270
Moment of inertia	J	kgcm ²	1.10	1.10	1.50	1.90	1.50	1.90
Efficiency	η		0.87	0.87	0.9	0.91	0.9	0.91
Torque constant	$K_{t_{0\ 150}}^{\circ C}$	Nm/A	0.320	0.623	0.400	0.458	0.700	0.647
Voltage constant	$K_{E_{LL\ 150}}^{\circ C}$	V/ (1000/ min)	17.89	34.81	22.29	26.01	39.01	36.96
Stator terminal resistance	$R_{UV\ 20}^{\circ C}$	Ω	0.45	1.75	0.415	0.356	1.333	0.889
Stator terminal resistance	$R_{UV\ 150}^{\circ C}$	Ω	0.678	2.637	0.625	0.536	2.009	1.34
Stator inductance	L	mH	1.70	6.30	2.00	2.00	6.20	4.00
Weight	m	kg	4.90	4.90	5.80	6.70	5.80	6.70



Technical data

Rated data

Inverter mains connection 230 V, Self-ventilated motors

Motor			MCS 09L41L	MCS 12H15L	MCS 12L20L	MCS 12D41L	MCS 12D20L	MCS 12H30L
Standstill torque	M_0	Nm	7.50	11.4	15.0	6.40	6.40	11.4
Rated torque	M_{rated}	Nm	4.50	10.0	13.5	4.30	5.50	8.00
Max. torque	M_{max}	Nm	32.0	29.0	56.0	18.0	18.0	29.0
Rated speed	n_{rated}	rpm	4050	1500	1950	4050	1950	3000
Max. speed	n_{max}	rpm	7000	6000	6000	6000	6000	6000
Rated power	P_{rated}	kW	1.9	1.6	2.8	1.8	1.1	2.5
Standstill current	I_0	A	12.4	8.20	12.4	10.7	5.50	13.5
Rated current	I_{rated}	A	8.40	7.60	11.8	8.80	5.20	10.5
Max. current	I_{max}	A	64.0	24.0	57.0	40.0	20.0	39.0
Rated voltage	V_{rated}	V	145	158	165	155	175	165
Rated frequency	f_{rated}	Hz	270	100	130	270	130	200
Moment of inertia	J	kgcm ²	2.80	7.30	10.6	4.00	4.00	7.30
Efficiency	η		0.91	0.86	0.9	0.84	0.85	0.87
Torque constant	$K_{t_{0\ 150}}$ °C	Nm/A	0.605	1.39	1.21	0.598	1.16	0.844
Voltage constant	$K_{E_{LL\ 150}}$ °C	V/ (1000/ min)	35.1	84.58	75.19	34.22	67.07	51.82
Stator terminal resistance	$R_{UV\ 20}$ °C	Ω	0.44	1.41	0.548	0.55	2.2	0.489
Stator terminal resistance	$R_{UV\ 150}$ °C	Ω	0.663	2.125	0.826	0.829	3.315	0.737
Stator inductance	L	mH	2.50	10.5	5.50	3.40	13.0	4.00
Weight	m	kg	8.50	10.2	13.3	7.10	7.10	10.2



Selection tables

Notes on the selection tables

The selection tables represent the combinations of servo motors and servo inverters. They serve as a rough overview.

In the case of the servo inverters, the overload capacity depending on the switching frequency in the default setting is taken into consideration. For more information, please refer to the inverter documentation.

Graphical representation of the operating points		Explanation	Notes
	M_0	Standstill torque	With a zero speed rpm, the standstill torque and standstill current are to be reduced by 30 % after 2 % seconds. For applications that require a longer holding of the standstill torque, it is recommended to hold the drive via the holding brake and, for instance, reducing the current by inverter disable.
	$M_{0,max}$	Max. standstill torque	With an active load observe (e. g. vertical drive axes, hoists, test benches, unwinders).
	M_N	Rated torque	
	n_N	Rated speed	
	M_{max}	Max. torque	Can usually be used with a passive load (e. g. horizontal drive axes).
	n_{eto}	Transition speed	
	n_k	Derating speed	Due to a derating of the inverter output current to the derating speed, for some inverters the achievable max. standstill torque is smaller than the max. speed when the value of 5 Hz is not reached.

Derating speed

Motor	Derating speed
	n_k
	rpm
MCS06	75
MCS09	
MCS12	
MCS14	
MCS19	



i950 cabinet servo inverter



The following data apply to a mains voltage 3x 400 V and a switching frequency 4 kHz of the inverter

MCS06 Self-ventilated

Motor	Inverter	Standstill torque	Rated torque	Max. standstill torque	Max. torque
		M_0	M_{rated}	$M_{0, max}$	M_{max}
		Nm	Nm	Nm	Nm
MCS 06C41-	I95AE155F	0.8	0.6	2.0	2.0
	I95AE175F			2.3	2.3
	I95AE222F			2.4	2.4
MCS 06C60-	I95AE155F	0.6	0.4	1.2	1.2
	I95AE175F	0.8	0.5	1.6	1.6
	I95AE222F			2.4	2.4
MCS 06F41-	I95AE155F	1.5	1.2	3.4	3.4
	I95AE175F			4.2	4.2
	I95AE222F			4.4	4.4
MCS 06F60-	I95AE155F	0.9	0.9	2.0	2.0
	I95AE175F	1.2		2.6	2.6
	I95AE222F	1.5		4.4	4.4
MCS 06I41-	I95AE155F	2.0	1.5	4.2	4.2
	I95AE175F			5.3	5.3
	I95AE222F			6.2	6.2
MCS 06I60-	I95AE155F	1.1	0.7	2.3	2.3
	I95AE175F	1.4	1.0	2.9	2.9
	I95AE222F	2.0	1.2	6.0	6.0
	I95AE240F			6.2	6.2



MCS09 Self-ventilated

Motor	Inverter	Standstill torque	Rated torque	Max. standstill torque	Max. torque
		M_0	M_{rated}	$M_{0,max}$	M_{max}
		Nm	Nm	Nm	Nm
MCS 09D41-	I95AE155F	2.3	1.8	4.6	4.6
	I95AE175F	3.0	2.3	5.9	5.9
	I95AE222F	3.3		9.5	9.5
MCS 09D60-	I95AE155F	1.1	0.9	2.4	2.4
	I95AE175F	1.5	1.1	3.2	3.2
	I95AE222F	3.3	1.8	6.5	6.5
	I95AE240F			9.3	9.3
	I95AE275F			9.5	9.5
MCS 09F38-	I95AE155F	2.5	2.2	5.0	5.0
	I95AE175F	3.4	3.0	6.5	6.5
	I95AE222F	4.2	3.1	12.7	12.7
	I95AE240F			15.0	15.0
MCS 09F60-	I95AE175F	1.7	1.3	3.5	3.5
	I95AE222F	3.9	2.4	7.4	7.4
	I95AE240F	4.2		11.3	11.3
	I95AE275F			15.0	15.0
MCS 09H41-	I95AE155F	2.3	2.0	4.7	4.7
	I95AE175F	3.1	2.7	6.2	6.2
	I95AE222F	5.5	3.8	13.0	13.0
	I95AE240F			19.4	19.4
	I95AE275F			20.0	20.0
MCS 09H60-	I95AE175F	1.6	1.2	3.2	3.2
	I95AE222F	3.6	2.8	7.2	7.2
	I95AE240F	5.5	3.0	11.5	11.5
	I95AE275F			17.6	17.6
	I95AE311F			20.0	20.0
MCS 09L41-	I95AE155F	2.2	1.9	4.5	4.5
	I95AE175F	2.9	2.6	6.0	6.0
	I95AE222F	6.8	4.5	13.4	13.4
	I95AE240F	7.5		21.3	21.3
	I95AE275F			32.0	32.0
MCS 09L51-	I95AE222F	3.4	2.9	7.0	7.0
	I95AE240F	5.7	3.6	11.5	11.5
	I95AE275F	7.5		18.9	18.9
	I95AE311F			25.4	25.4
		I95AE315F			32.0



MCS12 Self-ventilated

Motor	Inverter	Standstill torque	Rated torque	Max. standstill torque	Max. torque
		M_0	M_{rated}	$M_{0,max}$	M_{max}
		Nm	Nm	Nm	Nm
MCS 12D20-	I95AE155F	4.3	3.8	9.3	9.3
	I95AE175F	5.7	5.1	11.7	11.7
	I95AE222F	6.4	5.5	18.0	18.0
MCS 12D41-	I95AE175F	2.8	2.3	6.5	6.5
	I95AE222F	6.4	4.3	13.0	13.0
	I95AE240F			17.6	17.6
	I95AE275F			18.0	18.0
MCS 12H15-	I95AE155F	5.0	4.7	10.3	10.3
	I95AE175F	6.7	6.3	13.4	13.4
	I95AE222F	11.4	10.0	27.5	27.5
	I95AE240F			29.0	29.0
MCS 12H35-	I95AE175F	3.3	3.2	7.0	7.0
	I95AE222F	7.8	7.4	15.4	15.4
	I95AE240F	11.4	7.5	24.2	24.2
	I95AE275F			29.0	29.0
MCS 12L20-	I95AE175F	5.8	5.5	11.9	11.9
	I95AE222F	13.5	12.8	26.2	26.2
	I95AE240F	15.0	13.5	41.5	41.5
	I95AE275F			56.0	56.0
MCS 12L41-	I95AE222F	6.8	6.0	13.8	13.8
	I95AE240F	11.5	10.2	22.6	22.6
	I95AE275F	15.0	11.0	36.9	36.9
	I95AE311F			49.2	49.2
	I95AE315F			56.0	56.0



MCS14 Self-ventilated

Motor	Inverter	Standstill torque	Rated torque	Max. standstill torque	Max. torque
		M_0	M_{rated}	$M_{0, max}$	M_{max}
		Nm	Nm	Nm	Nm
MCS 14D15-	I95AE175F	5.3	4.9	10.6	10.6
	I95AE222F	11.0	9.2	22.0	22.0
	I95AE240F			29.0	29.0
MCS 14D36-	I95AE222F	6.2	5.6	12.2	12.2
	I95AE240F	10.5	7.5	19.3	19.3
	I95AE275F	11.0		29.0	29.0
MCS 14H15-	I95AE222F	13.8	13.6	27.1	27.1
	I95AE240F	21.0	16.0	43.1	43.1
	I95AE275F			55.1	55.1
MCS 14H32-	I95AE222F	7.0	6.6	14.2	14.2
	I95AE240F	11.8	11.2	23.4	23.4
	I95AE275F	20.5	14.0	38.3	38.3
	I95AE311F	21.0		51.2	51.2
	I95AE315F			55.0	55.0
MCS 14L15-	I95AE222F	13.1	13.3	26.2	26.2
	I95AE240F	22.2	22.5	42.9	42.9
	I95AE275F	28.0	23.0	69.7	69.7
	I95AE311F			77.1	77.1
MCS 14L32-	I95AE240F	11.1	10.9	22.4	22.4
	I95AE275F	19.3	17.2	37.7	37.7
	I95AE311F	27.4		52.0	52.0
	I95AE315F	28.0		67.9	67.9
	I95AE322F			77.0	77.0
MCS 14P14-	I95AE222F	17.0	15.6	34.2	34.2
	I95AE240F	28.8	26.4	54.8	54.8
	I95AE275F	37.0	30.0	84.9	84.9
	I95AE311F			105	105
MCS 14P32-	I95AE240F	14.5	12.8	29.5	29.5
	I95AE275F	25.1	21.0	48.6	48.6
	I95AE311F	35.8		65.6	65.6
	I95AE315F	37.0		83.2	83.2
	I95AE322F			105	105



MCS19 Self-ventilated

Motor	Inverter	Standstill torque	Rated torque	Max. standstill torque	Max. torque
		M_0	M_{rated}	$M_{0,max}$	M_{max}
		Nm	Nm	Nm	Nm
MCS 19F14-	I95AE222F	18.1	17.6	36.4	36.4
	I95AE240F	30.7	27.0	58.1	58.1
	I95AE275F	32.0		86.1	86.1
MCS 19F30-	I95AE240F	15.4	14.3	31.3	31.3
	I95AE275F	26.7	21.0	51.4	51.4
	I95AE311F	32.0		69.2	69.2
	I95AE315F			86.0	86.0
MCS 19J14-	I95AE222F	18.8	18.2	39.0	39.0
	I95AE240F	31.9	30.9	63.5	63.5
	I95AE275F	51.0	40.0	102	102
	I95AE311F			129	129
MCS 19J30-	I95AE240F	15.9	14.9	33.2	33.2
	I95AE275F	27.6	25.9	55.7	55.7
	I95AE311F	39.3	29.0	76.4	76.4
	I95AE315F	51.0		99.3	99.3
	I95AE322F			129	129
MCS 19P14-	I95AE240F	34.7	33.9	70.0	70.0
	I95AE275F	60.3	51.0	116	116
	I95AE311F	64.0		157	157
	I95AE315F			190	190
MCS 19P30-	I95AE240F	17.4	16.0	36.2	36.2
	I95AE275F	30.3	27.8	61.5	61.5
	I95AE311F	43.1	32.0	85.4	85.4
	I95AE315F	58.7		113	113
	I95AE322F	64.0		157	157
	I95AE330F			190	190



MCS12 Forced-ventilated

Motor	Inverter	Standstill torque	Rated torque	Max. standstill torque	Max. torque
		M_0	M_{rated}	$M_{0,max}$	M_{max}
		Nm	Nm	Nm	Nm
MCS 12D17-	I95AE155F	4.2	4.2	10.0	10.0
	I95AE175F	5.6	5.6	12.5	12.5
	I95AE222F	7.5	7.0	17.7	17.7
MCS 12D35-	I95AE175F	2.8	2.6	7.2	7.2
	I95AE222F	6.6	6.0	13.8	13.8
	I95AE240F	7.5		17.6	17.6
	I95AE275F			17.7	17.7
MCS 12H14-	I95AE155F	5.0	5.3	10.4	10.4
	I95AE175F	6.7	7.0	13.6	13.6
	I95AE222F	12.8	12.0	27.6	27.6
	I95AE240F			29.0	29.0
MCS 12H34-	I95AE222F	8.4	7.8	16.6	16.6
	I95AE240F	12.8	10.5	25.0	25.0
	I95AE275F			29.0	29.0
MCS 12L17-	I95AE222F	14.8	14.2	28.6	28.6
	I95AE240F	19.0	17.0	43.8	43.8
	I95AE275F			56.4	56.4
MCS 12L39-	I95AE222F	7.4	6.7	15.3	15.3
	I95AE240F	12.5	11.4	24.8	24.8
	I95AE275F	19.0	14.0	39.2	39.2
	I95AE311F			50.4	50.4
	I95AE315F			56.4	56.4



MCS14 Forced-ventilated

Motor	Inverter	Standstill torque	Rated torque	Max. standstill torque	Max. torque
		M_0	M_{rated}	$M_{0, max}$	M_{max}
		Nm	Nm	Nm	Nm
MCS 14D14-	I95AE175F	5.3	5.3	10.7	10.7
	I95AE222F	12.3	12.0	22.1	22.1
	I95AE240F	12.5		29.0	29.0
MCS 14D30-	I95AE222F	6.1	6.1	12.3	12.3
	I95AE240F	10.4	10.3	19.4	19.4
	I95AE275F	12.5	10.5	29.0	29.0
MCS 14H12-	I95AE222F	15.4	15.9	29.9	29.9
	I95AE240F	25.5	23.5	45.2	45.2
	I95AE275F			54.9	54.9
MCS 14H28-	I95AE240F	13.2	13.0	26.2	26.2
	I95AE275F	22.9	20.5	41.1	41.1
	I95AE311F	25.5		52.1	52.1
	I95AE315F			54.8	54.8
MCS 14L14-	I95AE222F	14.4	14.5	29.4	29.4
	I95AE240F	24.5	24.6	46.7	46.7
	I95AE275F	34.5	30.5	71.3	71.3
	I95AE311F			77.2	77.2
MCS 14L30-	I95AE240F	12.3	11.6	25.3	25.3
	I95AE275F	21.3	20.2	41.5	41.5
	I95AE311F	30.4	25.5	55.6	55.6
	I95AE315F	34.5		69.9	69.9
	I95AE322F			77.1	77.1
MCS 14P11-	I95AE222F	17.3	17.6	35.4	35.4
	I95AE240F	29.3	29.8	56.3	56.3
	I95AE275F	43.5	42.0	86.1	86.1
	I95AE311F			105	105
MCS 14P26-	I95AE240F	14.6	14.3	30.3	30.3
	I95AE275F	25.4	24.9	49.8	49.8
	I95AE311F	36.1	33.0	66.8	66.8
	I95AE315F	43.5		84.2	84.2
	I95AE322F			105	105

Technical data

Selection tables



MCS19 Forced-ventilated

Motor	Inverter	Standstill torque	Rated torque	Max. standstill torque	Max. torque
		M_0	M_{rated}	$M_{0,max}$	M_{max}
		Nm	Nm	Nm	Nm
MCS 19F12-	I95AE222F	19.0	18.8	39.6	39.6
	I95AE240F	32.3	31.9	61.4	61.4
	I95AE275F	41.5	38.0	86.1	86.1
MCS 19F29-	I95AE240F	16.1	15.4	34.1	34.1
	I95AE275F	27.9	26.7	54.8	54.8
	I95AE311F	39.8	32.5	71.7	71.7
	I95AE315F	41.5		86.0	86.0
MCS 19J12-	I95AE240F	33.0	32.4	68.9	68.9
	I95AE275F	57.3	56.4	106	106
	I95AE311F	70.5	62.5	129	129
MCS 19J29-	I95AE275F	28.7	26.9	61.1	61.1
	I95AE311F	40.8	50.5	82.2	82.2
	I95AE315F	55.6		104	104
	I95AE322F	70.5		129	129
MCS 19P12-	I95AE240F	36.5	32.1	76.0	76.0
	I95AE275F	63.3	55.8	123	123
	I95AE311F	86.0	72.0	161	161
	I95AE315F			190	190
MCS 19P29-	I95AE275F	31.7	29.6	67.0	67.0
	I95AE311F	45.2	42.2	92.0	92.0
	I95AE315F	61.6	53.0	120	120
	I95AE322F	86.0		161	161
	I95AE330F			190	190



The following data apply to a mains voltage 3x 230 V and a switching frequency 4 kHz of the inverter.

MCS06 Self-ventilated

Motor	Inverter	Standstill torque	Rated torque	Max. standstill torque	Max. torque
		M_0	M_{rated}	$M_{0,max}$	M_{max}
		Nm	Nm	Nm	Nm
MCS 06C41L	I95AE137D	0.8	0.6	1.6	1.6
	I95AE155D			1.9	1.9
	I95AE175D			2.2	2.2
	I95AE215D			2.4	2.4
MCS 06C60L	I95AE137D	0.4	0.3	1.0	1.0
	I95AE155D	0.6	0.4	1.3	1.3
	I95AE175D	0.8	0.5	1.6	1.6
	I95AE215D			2.2	2.2
	I95AE222C			2.4	2.4
MCS 06F41L	I95AE137D	1.2	1.0	2.6	2.6
	I95AE155D	1.5	1.2	3.2	3.2
	I95AE175D			3.9	3.9
	I95AE215D			4.4	4.4
MCS 06F60L	I95AE137D	0.9	0.6	2.1	2.1
	I95AE155D	1.3	0.8	2.6	2.6
	I95AE175D	1.5	0.9	3.2	3.2
	I95AE215D			4.2	4.2
	I95AE222C			4.4	4.4
MCS 06I41L	I95AE137D	2.0	1.2	3.2	3.2
	I95AE155D		1.5	4.1	4.1
	I95AE175D			5.0	5.0
	I95AE215D			6.2	6.2
MCS 06I60L	I95AE137D	1.1	0.8	2.5	2.5
	I95AE155D	1.5	1.1	3.2	3.2
	I95AE175D	2.0	1.2	4.0	4.0
	I95AE215D			5.8	5.8
	I95AE222C			6.2	6.2



MCS09 Self-ventilated

Motor	Inverter	Standstill torque	Rated torque	Max. standstill torque	Max. torque
		M_0	M_{rated}	$M_{0, max}$	M_{max}
		Nm	Nm	Nm	Nm
MCS 09D41L	I95AE137D	1.5	1.2	3.2	3.2
	I95AE155D	2.0	1.6	4.1	4.1
	I95AE175D	2.6	2.1	5.2	5.2
	I95AE215D	3.3	2.3	7.7	7.7
	I95AE222C			9.3	9.3
	I95AE240C			9.5	9.5
MCS 09D60L	I95AE155D	1.0	0.8	2.2	2.2
	I95AE175D	1.3	1.1	2.9	2.9
	I95AE215D	2.2	1.8	4.6	4.6
	I95AE222C	3.1		5.9	5.9
	I95AE240C	3.3		8.7	8.7
	I95AE255C			9.5	9.5
MCS 09F38L	I95AE137D	1.7	1.5	3.5	3.5
	I95AE155D	2.2	2.0	4.5	4.5
	I95AE175D	2.9	2.6	5.8	5.8
	I95AE215D	4.2	3.1	8.9	8.9
	I95AE222C			11.4	11.4
	I95AE240C			15.0	15.0
MCS 09F60L	I95AE155D	1.3	1.0	2.7	2.7
	I95AE175D	1.7	1.3	3.5	3.5
	I95AE215D	2.8	2.1	5.5	5.5
	I95AE222C	3.8	2.4	7.3	7.3
	I95AE240C	4.2		11.3	11.3
	I95AE255C			14.0	14.0
MCS 09H41L	I95AE155D	2.1	1.8	4.3	4.3
	I95AE175D	2.7	2.3	5.5	5.5
	I95AE215D	4.5	3.8	8.8	8.8
	I95AE222C	5.5		11.6	11.6
	I95AE240C			17.6	17.6
	I95AE255C			20.0	20.0
MCS 09H60L	I95AE155D	1.5	1.2	3.1	3.1
	I95AE175D	1.9	1.6	4.0	4.0
	I95AE215D	3.2	2.6	6.4	6.4
	I95AE222C	4.4	3.0	8.6	8.6
	I95AE240C	5.5		13.6	13.6
	I95AE255C			17.4	17.4
MCS 09L41L	I95AE175D	2.5	2.3	5.3	5.3
	I95AE215D	4.2	3.8	8.6	8.6
	I95AE222C	5.8	4.5	11.6	11.6
	I95AE240C	7.5		18.9	18.9
	I95AE255C			24.9	24.9



MCS12 Self-ventilated

Motor	Inverter	Standstill torque	Rated torque	Max. standstill torque	Max. torque
		M_0	M_{rated}	$M_{0,max}$	M_{max}
		Nm	Nm	Nm	Nm
MCS 12D20L	I95AE137D	2.8	2.5	6.5	6.5
	I95AE155D	3.7	3.4	8.3	8.3
	I95AE175D	4.9	4.4	10.4	10.4
	I95AE215D	6.4	5.5	15.1	15.1
	I95AE222C			17.7	17.7
I95AE240C			18.0	18.0	
MCS 12D41L	I95AE175D	2.5	2.1	5.9	5.9
	I95AE215D	4.2	3.4	9.2	9.2
	I95AE222C	5.7	4.3	11.8	11.8
	I95AE240C	6.4		16.7	16.7
	I95AE255C			18.0	18.0
MCS 12H15L	I95AE155D	4.4	4.2	9.2	9.2
	I95AE175D	5.8	5.5	11.8	11.8
	I95AE215D	9.7	9.2	18.7	18.7
	I95AE222C	11.4	10.0	24.4	24.4
	I95AE240C			29.0	29.0
MCS 12H30L	I95AE215D	5.9	5.3	12.0	12.0
	I95AE222C	8.1	7.3	16.0	16.0
	I95AE240C	11.4	8.0	25.4	25.4
	I95AE255C			29.0	29.0
MCS 12L20L	I95AE215D	8.5	11.0	17.0	17.0
	I95AE222C	11.6		22.8	22.8
	I95AE240C	15.0	13.5	36.7	36.7
	I95AE255C			47.9	47.9



9400 HighLine servo drives



The following data apply to a mains voltage 3x 400 V and a switching frequency 4 kHz of the inverter.

MCS06 Self-ventilated

Motor	Inverter	Standstill torque	Rated torque	Max. standstill torque	Max. torque
		M_0	M_{rated}	$M_{0, max}$	M_{max}
		Nm	Nm	Nm	Nm
MCS 06C41-	E94AXXE0024	0.8	0.6	2.4	2.4
MCS 06C60-		0.6	0.4	1.5	1.5
MCS 06F41-	E94AXXE0034	0.8	0.5	2.3	2.3
MCS 06F60-		1.5	1.2	4.4	4.4
MCS 06I41-	E94AXXE0024	1.0	0.7	3.0	3.0
MCS 06I60-		1.5	0.9	4.3	4.3
MCS 06I41-	E94AXXE0024	2.0	1.5	6.2	6.2
MCS 06I60-		1.1	0.8	3.3	3.3
MCS 06I60-	E94AXXE0034	1.8	1.2	5.5	5.5
MCS 06I60-	E94AXXE0044	2.0		6.2	6.2

MCS09 Self-ventilated

Motor	Inverter	Standstill torque	Rated torque	Max. standstill torque	Max. torque
		M_0	M_{rated}	$M_{0, max}$	M_{max}
		Nm	Nm	Nm	Nm
MCS 09D41-	E94AXXE0024	2.4	1.9	6.3	6.3
	E94AXXE0034	3.3	2.3	9.5	9.5
MCS 09D60-	E94AXXE0044	3.1	1.8	8.0	8.0
	E94AXXE0074	3.3		9.5	9.5
MCS 09F38-	E94AXXE0034	4.2	3.1	11.6	11.6
	E94AXXE0044			14.9	14.9
MCS 09F60-	E94AXXE0074	3.5	2.4	9.8	9.8
	E94AXXE0094			12.0	12.0
	E94AXXE0134	4.2		14.4	14.4
	E94AXXE0174			14.9	14.9
MCS 09H41-	E94AXXE0034	4.0	3.5	12.0	12.0
	E94AXXE0044	5.5	3.8	17.5	17.5
	E94AXXE0074			20.4	20.4
MCS 09H60-	E94AXXE0094	5.5		3.0	12.5
	E94AXXE0134		15.8		15.8
	E94AXXE0174		20.1		20.1
	E94AXXE0244		20.4		20.4
MCS 09L41-	E94AXXE0044	6.0	4.5	17.4	17.4
	E94AXXE0074	7.5		22.2	22.2
	E94AXXE0094			28.5	28.5
MCS 09L51-	E94AXXE0074	5.3	3.6	11.9	11.9
	E94AXXE0094	7.0		15.5	15.5
	E94AXXE0134	7.5		20.9	20.9
	E94AXXE0174			25.8	25.8
	E94AXXE0244			29.7	29.7



MCS12 Self-ventilated

Motor	Inverter	Standstill torque	Rated torque	Max. standstill torque	Max. torque
		M_0	M_{rated}	$M_{0,max}$	M_{max}
		Nm	Nm	Nm	Nm
MCS 12D20-	E94AXXE0024	4.4	4.0	11.8	11.8
	E94AXXE0034	6.4	5.5	17.7	17.7
MCS 12D41-	E94AXXE0044	5.9	4.3	14.7	14.7
	E94AXXE0074	6.4		17.7	17.7
MCS 12H15-	E94AXXE0034	8.7	8.2	24.6	24.6
	E94AXXE0044	11.4	10.0	29.0	29.0
MCS 12H35-	E94AXXE0074	7.0	6.6	20.1	20.1
	E94AXXE0094	11.4	7.5	25.8	25.8
	E94AXXE0134			29.0	29.0
	E94AXXE0044	12.1	11.4	35.5	35.5
MCS 12L20-	E94AXXE0074	15.0	13.5	44.6	44.6
	E94AXXE0094			55.7	55.7
	E94AXXE0134	56.4	56.4		
	E94AXXE0074	10.6	9.5	24.4	24.4
MCS 12L41-	E94AXXE0094	14.0	11.0	31.6	31.6
	E94AXXE0134	15.0		41.9	41.9
	E94AXXE0174			50.8	50.8
	E94AXXE0244			56.4	56.4



MCS14 Self-ventilated

Motor	Inverter	Standstill torque	Rated torque	Max. standstill torque	Max. torque
		M_0	M_{rated}	$M_{0, max}$	M_{max}
		Nm	Nm	Nm	Nm
MCS 14D15-	E94AXXE0044	11.0	9.2	28.3	28.3
	E94AXXE0074			29.0	29.0
MCS 14D36-	E94AXXE0094	9.6	7.5	20.2	20.2
	E94AXXE0134	11.0		25.6	25.6
				29.0	29.0
MCS 14H15-	E94AXXE0044	12.4	12.1	37.1	37.1
	E94AXXE0074	21.0	16.0	46.6	46.6
	E94AXXE0094			54.8	54.8
	E94AXXE0134				
E94AXXE0094	14.4			13.6	33.0
MCS 14H32-	E94AXXE0134	20.3	14.0	43.9	43.9
	E94AXXE0174	21.0		53.2	53.2
	E94AXXE0244			54.8	54.8
MCS 14L15-	E94AXXE0074	20.5	20.9	48.0	48.0
	E94AXXE0094	27.1	23.0	61.4	61.4
		28.0		77.1	77.1
E94AXXE0134	19.0	45.0		45.0	
MCS 14L32-	E94AXXE0174	24.0	17.2	55.3	55.3
	E94AXXE0244	28.0		63.9	63.9
	E94AXXE0324			77.1	77.1
	E94AXXE0474				
MCS 14P14-	E94AXXE0044	11.0	11.0	28.3	28.3
	E94AXXE0074	26.7	24.4	56.1	56.1
	E94AXXE0094	35.2	30.0	71.7	71.7
	E94AXXE0134	37.0		93.3	93.3
	E94AXXE0174			105	105
MCS 14P32-	E94AXXE0134	24.8	21.0	52.5	52.5
	E94AXXE0174	31.4		64.6	64.6
	E94AXXE0244	37.0		74.7	74.7
	E94AXXE0324			92.2	92.2
	E94AXXE0474			105	105



MCS19 Self-ventilated

Motor	Inverter	Standstill torque	Rated torque	Max. standstill torque	Max. torque
		M_0	M_{rated}	$M_{0,max}$	M_{max}
		Nm	Nm	Nm	Nm
MCS 19F14-	E94AXXE0074	28.4	27.0	62.1	62.1
	E94AXXE0094	32.0		78.9	78.9
	E94AXXE0134			86.0	86.0
MCS 19F30-	E94AXXE0174	26.3	21.0	56.6	56.6
	E94AXXE0244	32.0		70.2	70.2
	E94AXXE0324			81.6	81.6
				86.0	86.0
MCS 19J14-	E94AXXE0094	38.9	37.7	85.0	85.0
	E94AXXE0134	51.0	40.0	114	114
	E94AXXE0174			129	129
MCS 19J30-	E94AXXE0134	27.3		25.6	60.8
	E94AXXE0174	34.4	29.0	75.9	75.9
	E94AXXE0244	49.2		88.9	88.9
	E94AXXE0324	51.0		113	113
	E94AXXE0474			129	129
	128			128	
MCS 19P14-	E94AXXE0134	59.6	51.0	160	160
	E94AXXE0174	64.0		187	187
	E94AXXE0244			190	190
	E94AXXE0324				
MCS 19P30-	E94AXXE0134	29.9	27.5	65.7	65.7
	E94AXXE0174	37.8	32.0	83.6	83.6
	E94AXXE0244	53.9		98.5	98.5
	E94AXXE0324	64.0		127	127
	E94AXXE0474			153	153
	E94AXXE0594			187	187

MCS12 Forced-ventilated

Motor	Inverter	Standstill torque	Rated torque	Max. standstill torque	Max. torque
		M_0	M_{rated}	$M_{0,max}$	M_{max}
		Nm	Nm	Nm	Nm
MCS 12D17-	E94AXXE0024	4.4	4.0	11.8	11.8
	E94AXXE0034	7.3	7.0	17.7	17.7
MCS 12D35-	E94AXXE0044	5.9	5.4	14.7	14.7
	E94AXXE0074	7.5	6.0	17.7	17.7
MCS 12H14-	E94AXXE0034	8.7	8.2	24.6	24.6
	E94AXXE0044	12.8	12.0	29.0	29.0
MCS 12H34-		7.0	6.6	20.1	20.1
	E94AXXE0074	12.8	10.5	25.8	25.8
	E94AXXE0094			29.0	29.0
	E94AXXE0134				
MCS 12L17-	E94AXXE0044	12.1		11.4	35.5
	E94AXXE0074	19.0	17.0	44.6	44.6
	E94AXXE0094			55.7	55.7
	E94AXXE0134			56.4	56.4
MCS 12L39-	E94AXXE0074	10.6	9.5	24.4	24.4
	E94AXXE0094	15.3	13.9	31.6	31.6
	E94AXXE0134	19.0	14.0	41.9	41.9
	E94AXXE0174			50.8	50.8
	E94AXXE0244			56.4	56.4

Technical data

Selection tables



MCS14 Forced-ventilated

Motor	Inverter	Standstill torque	Rated torque	Max. standstill torque	Max. torque
		M_0	M_{rated}	$M_{0,max}$	M_{max}
		Nm	Nm	Nm	Nm
MCS 14D30-	E94AXXE0074	9.6	9.5	20.2	20.2
	E94AXXE0094	12.5	10.5	25.6	25.6
	E94AXXE0134			29.0	29.0
MCS 14H12-	E94AXXE0044	12.4	12.1	37.1	37.1
	E94AXXE0074	24.1	23.5	46.6	46.6
	E94AXXE0094	25.5		54.8	54.8
	E94AXXE0134				
MCS 14H28-	E94AXXE0094	16.1	15.9	33.0	33.0
	E94AXXE0134	20.5	20.5	43.9	43.9
	E94AXXE0174	25.5		53.2	53.2
	E94AXXE0244			54.8	54.8
MCS 14L14-	E94AXXE0074	20.5			48.0
	E94AXXE0094	30.0	30.0	61.4	61.4
	E94AXXE0134	34.5	30.5	77.1	77.1
MCS 14L30-	E94AXXE0174	21.0	20.0	45.0	45.0
MCS 14P11-	E94AXXE0074	26.7	24.4	56.1	56.1
	E94AXXE0094	36.4	36.4	71.7	71.7
	E94AXXE0134	43.5	42.0	93.3	93.3
	E94AXXE0174			105	105
MCS 14P26-	E94AXXE0134	24.8	24.6	52.5	52.5
	E94AXXE0174	31.4	31.0	64.6	64.6
	E94AXXE0244	43.5	33.0	74.7	74.7
	E94AXXE0324			92.2	92.2
	E94AXXE0474			105	105

MCS19 Forced-ventilated

Motor	Inverter	Standstill torque	Rated torque	Max. standstill torque	Max. torque
		M_0	M_{rated}	$M_{0,max}$	M_{max}
		Nm	Nm	Nm	Nm
MCS 19F12-	E94AXXE0074	29.9	29.3	62.1	62.1
	E94AXXE0094	39.5	38.0	78.9	78.9
	E94AXXE0134	41.5		86.0	86.0
MCS 19F29-		26.3	26.0	56.6	56.6
	E94AXXE0174	34.9	32.5	70.2	70.2
	E94AXXE0244	41.5		81.6	81.6
	E94AXXE0324			86.0	86.0
MCS 19J12-	E94AXXE0134	56.6	55.7	114	114
	E94AXXE0174	70.5	62.5	129	129
MCS 19J29-	E94AXXE0244	49.2	47.9	88.9	88.9
	E94AXXE0324	66.7	50.5	113	113
	E94AXXE0474	70.5		129	129
MCS 19P12-	E94AXXE0174	79.1	69.6	160	160
	E94AXXE0244	86.0	72.0	187	187
	E94AXXE0324			190	190
MCS 19P29-	E94AXXE0244	56.5		52.8	98.5
	E94AXXE0324	73.9	53.0	127	127
	E94AXXE0474	86.0		153	153
	E94AXXE0594			187	187



The following data apply to a mains voltage 3x 230 V and a switching frequency 4 kHz of the inverter

MCS06 Self-ventilated

Motor	Inverter	Standstill torque	Rated torque	Max. standstill torque	Max. torque
		M_0	M_{rated}	$M_{0, max}$	M_{max}
		Nm	Nm	Nm	Nm
MCS 06C41L	E94AXXE0024	0.6	0.5	1.5	1.5
	E94AXXE0034	0.8	0.6	2.3	2.3
MCS 06C60L	E94AXXE0034	0.6	0.4	1.5	1.5
	E94AXXE0044	0.8	0.5	2.2	2.2
	E94AXXE0074			2.4	2.4
MCS 06F41L	E94AXXE0024	1.0	0.8	2.7	2.7
	E94AXXE0034	1.5	1.2	4.2	4.2
	E94AXXE0044			4.4	4.4
MCS 06F60L	E94AXXE0034	1.2	0.8	3.1	3.1
	E94AXXE0044	1.5	0.9	4.3	4.3
	E94AXXE0074			4.4	4.4
MCS 06I41L	E94AXXE0034	2.0	1.5	5.4	6.2
	E94AXXE0044				
MCS 06I60L	E94AXXE0034	1.5	1.0	4.4	4.4
	E94AXXE0044	2.0	1.2	6.2	6.2



MCS09 Self-ventilated

Motor	Inverter	Standstill torque	Rated torque	Max. standstill torque	Max. torque
		M_0	M_{rated}	$M_{0,max}$	M_{max}
		Nm	Nm	Nm	Nm
MCS 09D41L	E94AXXE0044	3.1	2.3	8.0	8.0
	E94AXXE0074	3.3		9.5	9.5
MCS 09D60L	E94AXXE0094	2.8	1.8	5.7	5.7
	E94AXXE0134	3.3		7.3	7.3
				9.5	9.5
MCS 09F38L	E94AXXE0044	3.5	3.1	9.8	9.8
	E94AXXE0074	4.2		12.0	12.0
	E94AXXE0094			13.8	13.8
	E94AXXE0134			15.0	15.0
MCS 09F60L	E94AXXE0074	3.5	2.4	7.8	7.8
	E94AXXE0094	4.2		9.8	9.8
	E94AXXE0134			12.6	12.6
	E94AXXE0174			14.5	14.5
	E94AXXE0244			15.0	15.0
MCS 09H41L	E94AXXE0074	5.5	3.8	12.4	12.4
	E94AXXE0094	5.3	3.0	11.8	11.8
	E94AXXE0134	5.5	3.8	19.7	19.7
	E94AXXE0174			20.0	20.0
MCS 09H60L	E94AXXE0074	4.0	3.0	9.2	9.2
	E94AXXE0094	5.5	3.8	15.6	15.6
	E94AXXE0134		3.0	15.4	15.4
	E94AXXE0174			18.3	18.3
	E94AXXE0244			20.0	20.0
MCS 09L41L	E94AXXE0074	5.3	4.5	11.9	11.9
	E94AXXE0094	7.0		15.5	15.5
	E94AXXE0134	7.5		20.9	20.9
	E94AXXE0174			25.8	25.8
	E94AXXE0244			29.7	29.7
	E94AXXE0324			31.9	31.9

MCS12 Self-ventilated

Motor	Inverter	Standstill torque	Rated torque	Max. standstill torque	Max. torque
		M_0	M_{rated}	$M_{0,max}$	M_{max}
		Nm	Nm	Nm	Nm
MCS 12D20L	E94AXXE0044	5.9	5.3	14.9	14.9
	E94AXXE0074	6.4	5.5	17.7	17.7
MCS 12D41L	E94AXXE0094	5.3	4.3	10.6	10.6
	E94AXXE0134	6.4		13.6	13.6
	E94AXXE0174			17.7	17.7
				17.9	17.9
MCS 12H15L	E94AXXE0074	11.4	10.0	25.8	25.8
	E94AXXE0094			29.0	29.0
	E94AXXE0134	10.0			11.4
MCS 12H30L	E94AXXE0074	7.4	6.7	16.4	16.4
	E94AXXE0094	9.8	8.0	21.5	21.5
	E94AXXE0134	11.4		29.0	29.0
MCS 12L20L	E94AXXE0074	10.6	10.1	24.4	24.4
	E94AXXE0094	14.0	13.3	31.5	31.5
	E94AXXE0134	15.0	13.5	41.8	41.8
	E94AXXE0174			50.5	50.5
	E94AXXE0244			56.0	56.0



8400 TopLine inverter drives



The following data apply to a mains voltage 3x 400 V and a switching frequency 8 kHz of the inverter.

MCS06 Self-ventilated

Motor	Inverter	Standstill torque	Rated torque	Max. standstill torque	Max. torque
		M_0	M_{rated}	$M_{0, max}$	M_{max}
		Nm	Nm	Nm	Nm
MCS 06C41-	E84AVTCX3714	0.8	0.6	1.4	1.4
	E84AVTCX5514			1.7	1.7
	E84AVTCX7514			2.3	2.3
	E84AVTCX1124			2.4	2.4
	E84AVTCX1524				
MCS 06C60-	E84AVTCX7514	0.5	0.5	1.3	1.3
	E84AVTCX1124			1.6	1.6
	E84AVTCX1524			2.0	2.0
	E84AVTCX2224			2.4	2.4
	E84AVTCX3024				
MCS 06F41-	E84AVTCX3714	1.3	1.0	2.3	2.3
	E84AVTCX5514	1.5	1.2	3.2	3.2
	E84AVTCX7514			4.3	4.3
	E84AVTCX1124			4.4	4.4
	E84AVTCX1524				
MCS 06F60-	E84AVTCX7514	1.2	0.9	2.1	2.1
	E84AVTCX1124	1.5		3.3	2.0
	E84AVTCX1524			4.0	2.4
	E84AVTCX2224			4.4	3.3
	E84AVTCX3024				
MCS 06I41-	E84AVTCX3714	1.6	1.2	2.9	2.9
	E84AVTCX5514	2.0	1.5	4.0	4.0
	E84AVTCX7514			5.3	5.3
	E84AVTCX1124			6.2	6.2
	E84AVTCX1524				
MCS 06I60-	E84AVTCX1124	2.0	1.2	3.6	3.6
	E84AVTCX1524			4.4	4.4
	E84AVTCX2224			5.7	5.7
	E84AVTCX3024				



MCS09 Self-ventilated

Motor	Inverter	Standstill torque	Rated torque	Max. standstill torque	Max. torque	
		M_0	M_{rated}	$M_{0,max}$	M_{max}	
		Nm	Nm	Nm	Nm	
MCS 09D41-	E84AVTCX5514	2.2	1.7	4.0	4.0	
	E84AVTCX7514	3.1	2.3	5.3	5.3	
	E84AVTCX1124	3.3		6.7	6.7	
	E84AVTCX1524			8.2	8.2	
	E84AVTCX2224			9.4	9.4	9.4
	E84AVTCX3024					
MCS 09D60-	E84AVTCX1124	2.0	1.5	3.5	3.5	
	E84AVTCX1524	2.4	1.8	4.2	4.2	
	E84AVTCX2224	3.3		6.3	6.3	
	E84AVTCX3024			7.8	7.8	
	E84AVTCX4024	1.8	3.3	9.1	9.1	
	E84AVTCX5524		9.3	9.3		
MCS 09F38-	E84AVTCX7514	3.4	3.0	6.6	6.6	
	E84AVTCX1124	4.2	3.1	8.4	8.4	
	E84AVTCX1524			10.2	10.2	
	E84AVTCX2224			12.0	12.0	12.0
	E84AVTCX3024					
MCS 09F60-	E84AVTCX2224	4.2	2.4	7.8	7.8	
	E84AVTCX3024			9.6	9.6	
	E84AVTCX4024			11.1	11.1	
	E84AVTCX5524			11.4	11.4	
MCS 09H41-	E84AVTCX1124	4.7	3.6	8.1	8.1	
	E84AVTCX1524	5.0	3.8	9.9	9.9	
	E84AVTCX2224	5.5		14.0	14.0	
	E84AVTCX3024			17.4	17.4	
	E84AVTCX4024			19.6	19.6	
	E84AVTCX5524			20.1	20.1	
MCS 09H60-	E84AVTCX2224	4.4	3.0	7.5	7.5	
	E84AVTCX3024	4.5		9.3	9.3	
	E84AVTCX4024	5.5		11.4	11.4	
	E84AVTCX5524			11.7	11.7	
MCS 09L41-	E84AVTCX1124	3.9	3.4	7.3	7.3	
	E84AVTCX1524	4.7	4.2	8.9	8.9	
	E84AVTCX2224	7.5	4.5	13.1	13.1	
	E84AVTCX3024			16.3	16.3	
	E84AVTCX4024			20.3	20.3	
	E84AVTCX5524			20.8	20.8	
MCS 09L51-	E84AVTCX3024	4.2	3.6	8.3	8.3	
	E84AVTCX4024	7.5		10.8	10.8	
	E84AVTCX5524			19.1	19.1	19.1
	E84AVTCX7524					
	E84AVTCX1134					



MCS12 Self-ventilated

Motor	Inverter	Standstill torque	Rated torque	Max. standstill torque	Max. torque
		M_0	M_{rated}	$M_{0, max}$	M_{max}
		Nm	Nm	Nm	Nm
MCS 12D20-	E84AVTCX7514	5.7	5.1	9.6	9.6
	E84AVTCX1124	6.4	5.5	12.6	12.6
	E84AVTCX1524			15.3	15.3
	E84AVTCX2224			17.7	17.7
	E84AVTCX3024				
MCS 12D41-	E84AVTCX1124	3.8	3.0	6.4	6.4
	E84AVTCX1524	4.6	3.7	7.8	7.8
	E84AVTCX2224	6.4	4.3	11.4	11.4
	E84AVTCX3024			14.0	14.0
	E84AVTCX4024			16.9	16.9
	E84AVTCX5524			17.3	17.3
MCS 12H15-	E84AVTCX1124	9.2	8.4	16.4	16.4
	E84AVTCX1524	10.9	10.0	20.0	20.0
	E84AVTCX2224	11.4		29.0	29.0
	E84AVTCX3024			28.3	28.3
	E84AVTCX4024			29.0	29.0
	E84AVTCX5524				
MCS 12H35-	E84AVTCX2224	9.8	7.5	15.2	15.2
	E84AVTCX3024	11.4		18.8	18.8
	E84AVTCX4024			23.5	23.5
	E84AVTCX5524			24.1	24.1
MCS 12L20-	E84AVTCX2224	15.0	13.5	27.4	27.4
	E84AVTCX3024			33.9	33.9
	E84AVTCX4024			40.8	40.8
	E84AVTCX5524			41.9	41.9
MCS 12L41-	E84AVTCX4024	14.0	10.2	22.2	22.2
	E84AVTCX5524	15.0	11.0	30.4	30.4
	E84AVTCX7524			35.5	49.6
	E84AVTCX1134				
	E84AVTCX1534				



MCS14 Self-ventilated

Motor	Inverter	Standstill torque	Rated torque	Max. standstill torque	Max. torque
		M_0	M_{rated}	$M_{0, max}$	M_{max}
		Nm	Nm	Nm	Nm
MCS 14D15-	E84AVTCX1124	7.0	6.6	13.1	13.1
	E84AVTCX1524	8.5	8.0	16.0	16.0
	E84AVTCX2224	11.0	9.2	22.7	22.7
	E84AVTCX3024			28.1	28.1
	E84AVTCX4024			28.3	28.3
	E84AVTCX5524			29.0	29.0
MCS 14D36-	E84AVTCX3024	8.0	7.3	15.2	15.2
	E84AVTCX4024	11.0	7.5	18.5	18.5
	E84AVTCX5524			25.3	22.2
	E84AVTCX7524			29.0	22.0
	E84AVTCX1134				
MCS 14H15-	E84AVTCX3024	17.3	16.0	35.3	35.3
	E84AVTCX4024	21.0		42.8	42.8
	E84AVTCX5524			43.9	43.9
MCS 14H32-	E84AVTCX4024	12.9	11.2	23.2	23.2
	E84AVTCX5524	16.2	14.0	31.7	31.7
	E84AVTCX7524	21.0		37.1	51.9
	E84AVTCX1134				
	E84AVTCX1534				
MCS 14L15-	E84AVTCX4024	27.4	22.5	43.8	43.8
	E84AVTCX5524	28.0	23.0	52.9	60.0
	E84AVTCX7524			73.8	
	E84AVTCX1134				
MCS 14L32-	E84AVTCX5524	15.2	14.9	31.3	31.3
	E84AVTCX7524	27.4	17.2	39.7	57.6
	E84AVTCX1134				
	E84AVTCX1534	28.0	52.9	73.9	
	E84AVTCX1834				
	E84AVTCX2234				
MCS 14P14-	E84AVTCX4024	32.5	26.4	51.2	51.2
	E84AVTCX5524	37.0	30.0	70.0	70.0
	E84AVTCX7524			80.0	105
	E84AVTCX1134				
	E84AVTCX1534				
MCS 14P32-	E84AVTCX5524	19.8	17.5	36.5	36.5
	E84AVTCX7524	35.8	21.0	46.3	67.3
	E84AVTCX1134				
	E84AVTCX1534	37.0	61.8	86.4	
	E84AVTCX1834				
	E84AVTCX2234				



MCS19 Self-ventilated

Motor	Inverter	Standstill torque	Rated torque	Max. standstill torque	Max. torque
		M_0	M_{rated}	$M_{0, max}$	M_{max}
		Nm	Nm	Nm	Nm
MCS 19F14-	E84AVTCX3024	23.6	22.9	45.9	45.9
	E84AVTCX4024	32.0	27.0	56.7	56.7
	E84AVTCX5524			68.3	77.6
	E84AVTCX7524				86.0
	E84AVTCX1134				
MCS 19F30-	E84AVTCX5524	21.0	19.5	47.2	38.9
	E84AVTCX7524	32.0	21.0		68.3
	E84AVTCX1134				
	E84AVTCX1534				
MCS 19J14-	E84AVTCX5524	43.6	40.0	81.1	81.1
	E84AVTCX7524	51.0		96.0	129
	E84AVTCX1134				
	E84AVTCX1534				
MCS 19J30-	E84AVTCX1134	39.3	29.0	73.6	110
	E84AVTCX1534	51.0		79.5	128
	E84AVTCX1834				
	E84AVTCX2234				
	E84AVTCX3034				
MCS 19P14-	E84AVTCX5524	47.5	46.4	92.7	92.7
	E84AVTCX7524	64.0	51.0	107	156
	E84AVTCX1134				
	E84AVTCX1534				
MCS 19P30-	E84AVTCX1134	43.1	32.0	79.2	119
	E84AVTCX1534	58.7		87.6	144
	E84AVTCX1834	64.0			
	E84AVTCX2234				
	E84AVTCX3034				

Technical data

Selection tables



MCS12 Forced-ventilated

Motor	Inverter	Standstill torque	Rated torque	Max. standstill torque	Max. torque
		M_0	M_{rated}	$M_{0,max}$	M_{max}
		Nm	Nm	Nm	Nm
MCS 12D17-	E84AVTCX1124	7.5	7.0	12.6	12.6
	E84AVTCX1524			15.3	15.3
	E84AVTCX2224			17.7	17.7
	E84AVTCX3024				
MCS 12D35-	E84AVTCX1524	4.6	3.7	7.8	7.8
	E84AVTCX2224	7.5	6.0	11.4	11.4
	E84AVTCX3024			14.0	14.0
	E84AVTCX4024			16.9	16.9
	E84AVTCX5524			17.3	17.3
MCS 12H14-	E84AVTCX1124	8.9	8.5	16.4	16.4
	E84AVTCX1524	10.9	10.3	20.0	20.0
	E84AVTCX2224	12.8	12.0	29.0	29.0
	E84AVTCX3024			28.3	28.3
	E84AVTCX4024				
	E84AVTCX5524				
MCS 12H34-	E84AVTCX3024	10.2	10.0	18.8	18.8
	E84AVTCX4024	12.8	10.5	23.5	23.5
	E84AVTCX5524			24.1	24.1
MCS 12L17-	E84AVTCX3024	18.5	17.0	33.9	33.9
	E84AVTCX4024	19.0		40.8	40.8
	E84AVTCX5524			41.9	41.9
MCS 12L39-	E84AVTCX4024	17.2	14.0	22.2	22.2
	E84AVTCX5524			30.4	30.4
	E84AVTCX7524	19.0		35.5	49.6
	E84AVTCX1134				
	E84AVTCX1534				



MCS14 Forced-ventilated

Motor	Inverter	Standstill torque	Rated torque	Max. standstill torque	Max. torque
		M_0	M_{rated}	$M_{0, max}$	M_{max}
		Nm	Nm	Nm	Nm
MCS 14D14-	E84AVTCX1524	8.5	8.0	16.0	16.0
	E84AVTCX2224	12.5	12.0	22.7	22.7
	E84AVTCX3024			28.1	28.1
	E84AVTCX4024			28.3	28.3
	E84AVTCX5524			29.0	29.0
MCS 14D30-	E84AVTCX3024	7.7	7.0	15.2	15.2
	E84AVTCX4024	12.2	9.8	18.5	18.5
	E84AVTCX5524	12.5	10.0	25.3	22.2
	E84AVTCX7524			29.0	
	E84AVTCX1134				
MCS 14H12-	E84AVTCX3024	18.0	17.9	35.3	35.3
	E84AVTCX4024	25.5	23.5	42.8	42.8
	E84AVTCX5524			43.9	43.9
MCS 14H28-	E84AVTCX5524	16.2	16.1	31.7	31.7
	E84AVTCX7524	25.5	20.5	37.1	51.9
	E84AVTCX1134				
	E84AVTCX1534				
MCS 14L14-	E84AVTCX4024	26.9	24.6	43.8	43.8
	E84AVTCX5524	33.4	30.5	52.9	60.0
	E84AVTCX7524	34.5			73.8
MCS 14L30-	E84AVTCX1134	27.4	25.5		52.9
	E84AVTCX1534	34.5			
	E84AVTCX1834				
	E84AVTCX2234				
MCS 14P11-	E84AVTCX5524	38.9	38.8	70.0	70.0
	E84AVTCX7524	43.5	42.0	80.0	105
	E84AVTCX1134				
	E84AVTCX1534				

MCS19 Forced-ventilated

Motor	Inverter	Standstill torque	Rated torque	Max. standstill torque	Max. torque
		M_0	M_{rated}	$M_{0, max}$	M_{max}
		Nm	Nm	Nm	Nm
MCS 19F12-	E84AVTCX3024	23.6	22.9	45.9	45.9
	E84AVTCX4024	34.9	31.9	56.7	56.7
	E84AVTCX5524	41.5	38.0	68.3	77.6
	E84AVTCX7524				86.0
MCS 19F29-	E84AVTCX1134	39.9	32.5	47.2	68.3
	E84AVTCX1534				
MCS 19J12-	E84AVTCX5524	43.6	43.4	81.1	81.1
	E84AVTCX1134	70.5	62.5	96.0	129
MCS 19J29-	E84AVTCX1534	55.5	50.5	87.6	128
	E84AVTCX1834	70.5			
	E84AVTCX2234				
	E84AVTCX3034				
MCS 19P12-	E84AVTCX5524	47.5	46.4	92.7	92.7
	E84AVTCX1134	86.0	72.0	107	156
MCS 19P29-	E84AVTCX1534	58.7	53.0	87.6	144
	E84AVTCX1834	86.0			
	E84AVTCX2234				
	E84AVTCX3034				

Technical data

Torque characteristics



Torque characteristics



The torque/speed characteristic for your motor/inverter combination can be found on the Internet:

<http://www.lenze.com> → Product Finder → M-n characteristics



The following data apply to a mains voltage 3 x 400 V of the inverter.

MCS06C41- (self-ventilated)

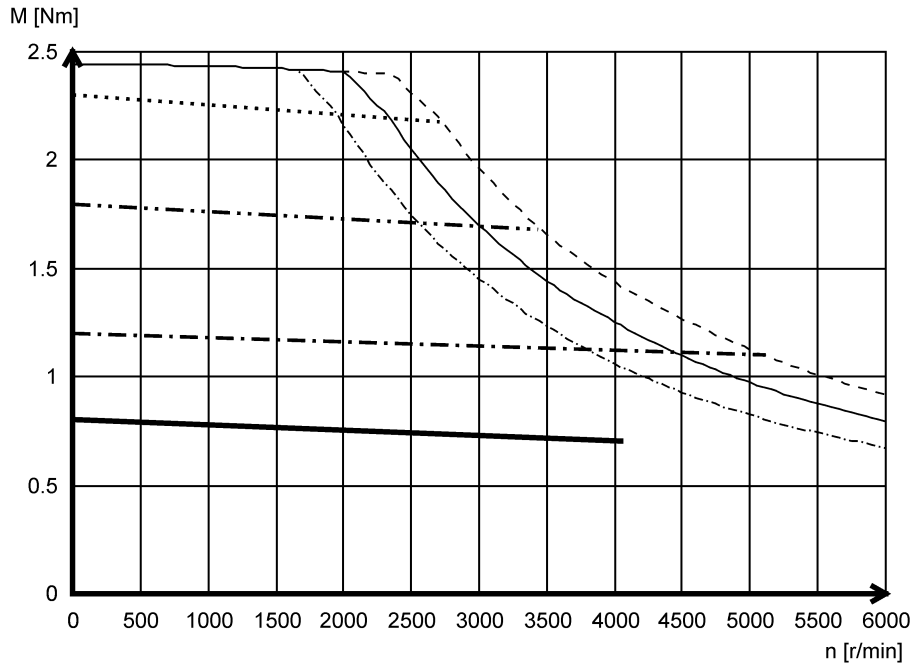

- Mmax 440 V
- Mmax 400 V
- - - - Mmax 360 V
- Mmax @ I_{max}= 4x I₀
- · - · Mmax @ I_{max}= 3x I₀
- · - · Mmax @ I_{max}= 2x I₀
- S1

MCS06C60- (self-ventilated)

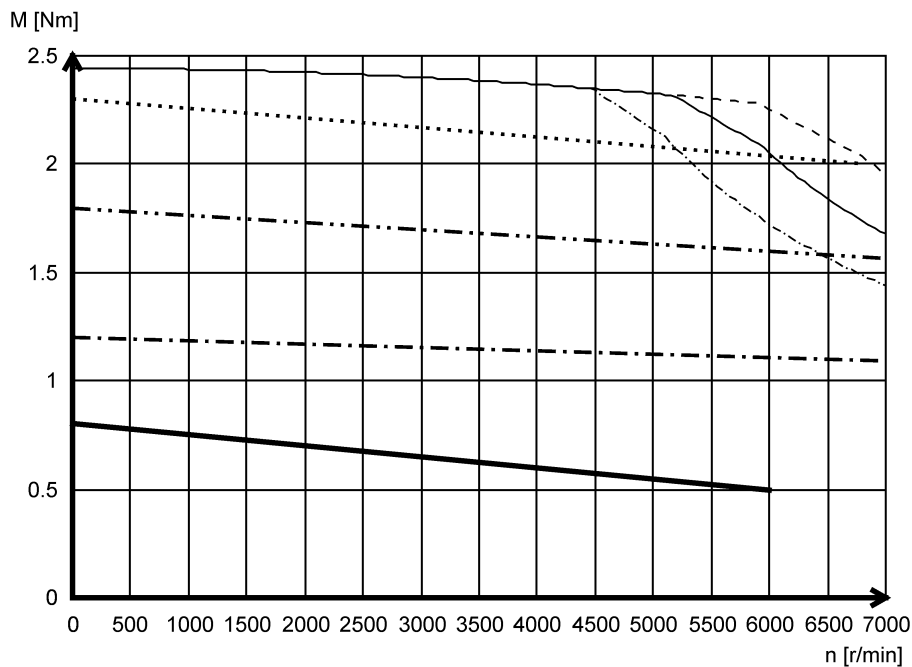

- Mmax 440 V
- Mmax 400 V
- - - - Mmax 360 V
- Mmax @ I_{max}= 4x I₀
- · - · Mmax @ I_{max}= 3x I₀
- · - · Mmax @ I_{max}= 2x I₀
- S1



MCS06F41- (self-ventilated)

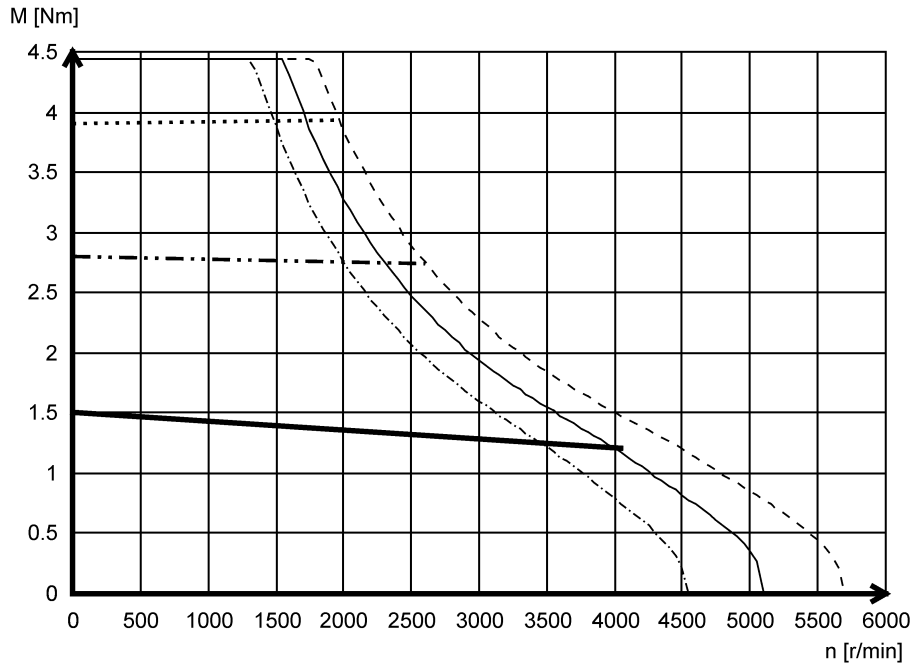

- Mmax 440 V
- Mmax 400 V
- - - - Mmax 360 V
- Mmax @ I_{max}= 3x I₀
- · - · Mmax @ I_{max}= 2x I₀
- S1

MCS06F60- (self-ventilated)

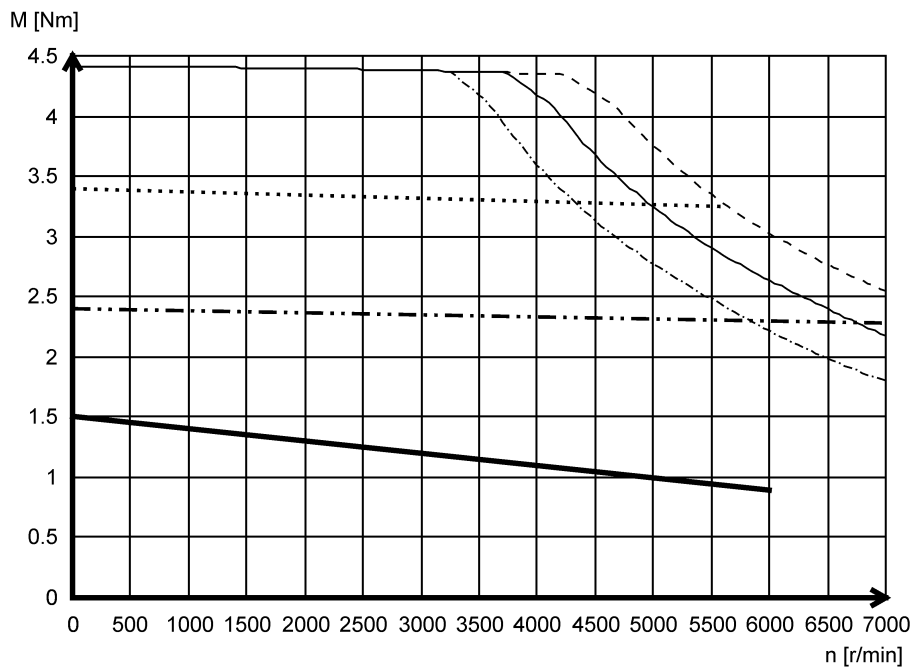

- Mmax 440 V
- Mmax 400 V
- - - - Mmax 360 V
- Mmax @ I_{max}= 3x I₀
- · - · Mmax @ I_{max}= 2x I₀
- S1

Technical data

Torque characteristics



MCS06I41- (self-ventilated)

M [Nm]

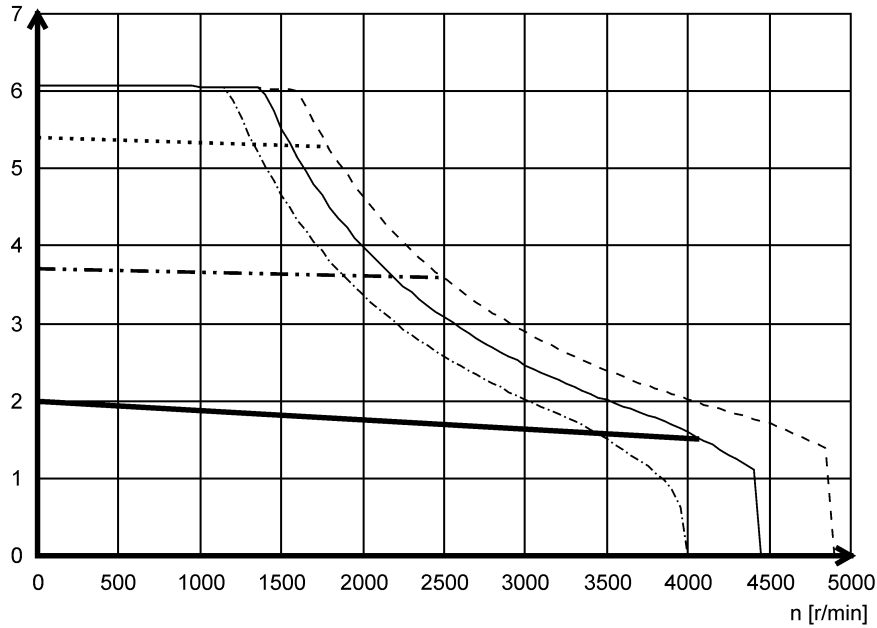

- Mmax 440 V
- Mmax 400 V
- - - - Mmax 360 V
- Mmax @ Imax= 3x I0
- · - · Mmax @ Imax= 2x I0
- S1

MCS06I60- (self-ventilated)

M [Nm]

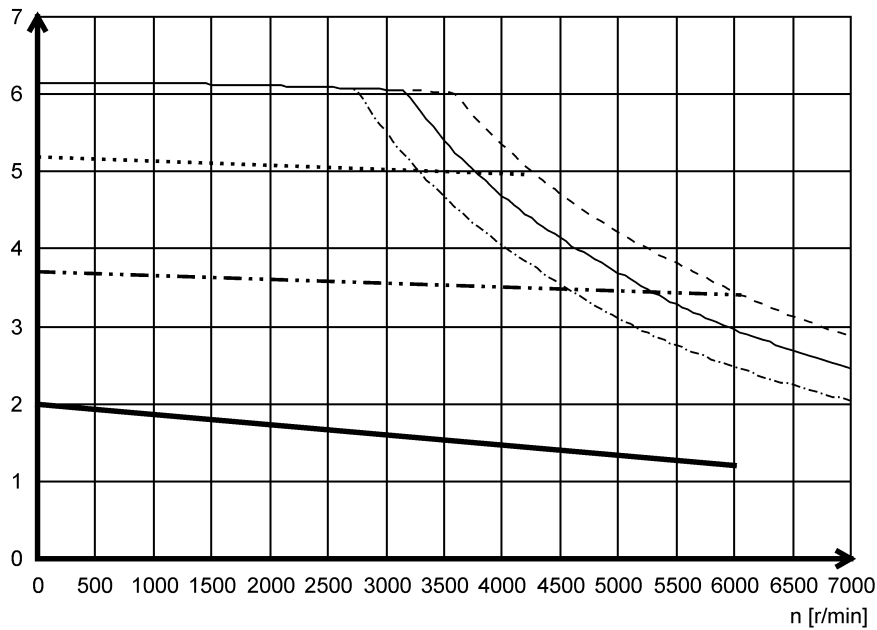

- Mmax 440 V
- Mmax 400 V
- - - - Mmax 360 V
- Mmax @ Imax= 3x I0
- · - · Mmax @ Imax= 2x I0
- S1



Technical data

Torque characteristics

MCS09D41- (self-ventilated)

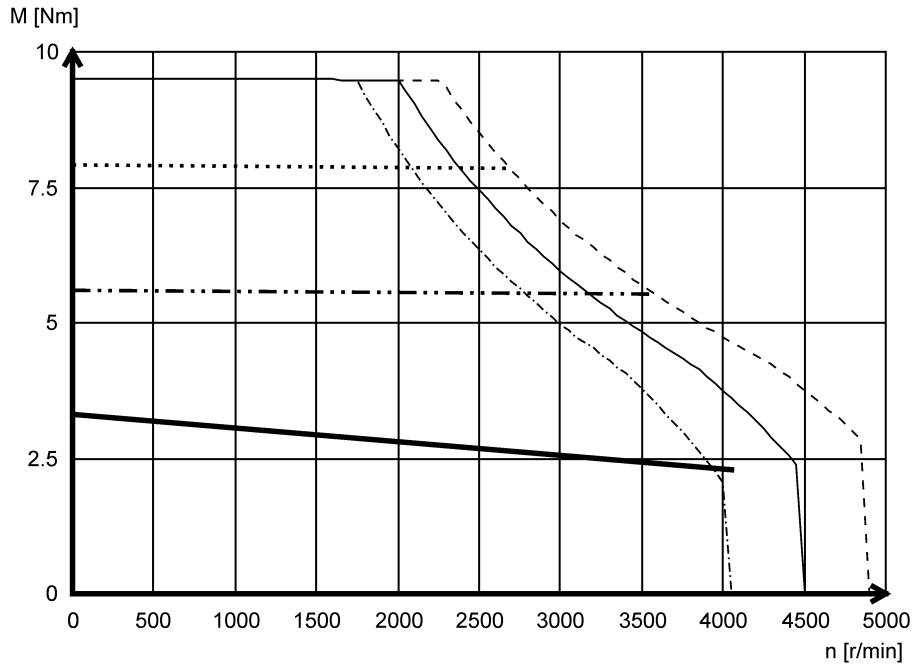

- Mmax 440 V
- Mmax 400 V
- · - · Mmax 360 V
- Mmax @ Imax= 3x I0
- · · - Mmax @ Imax= 2x I0
- S1

MCS09D60- (self-ventilated)

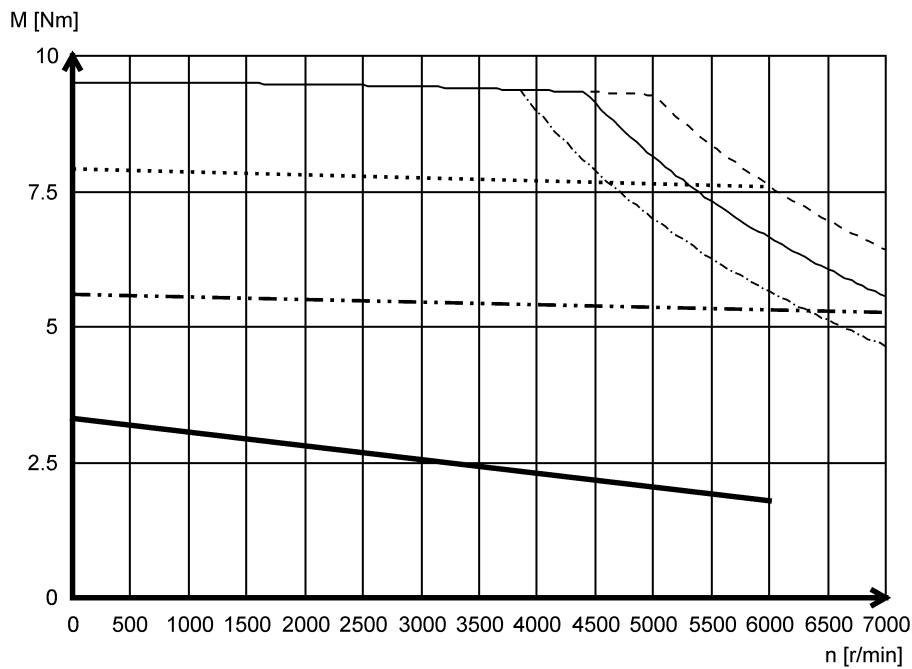

- Mmax 440 V
- Mmax 400 V
- · - · Mmax 360 V
- Mmax @ Imax= 3x I0
- · · - Mmax @ Imax= 2x I0
- S1

Technical data

Torque characteristics



MCS09F38- (self-ventilated)

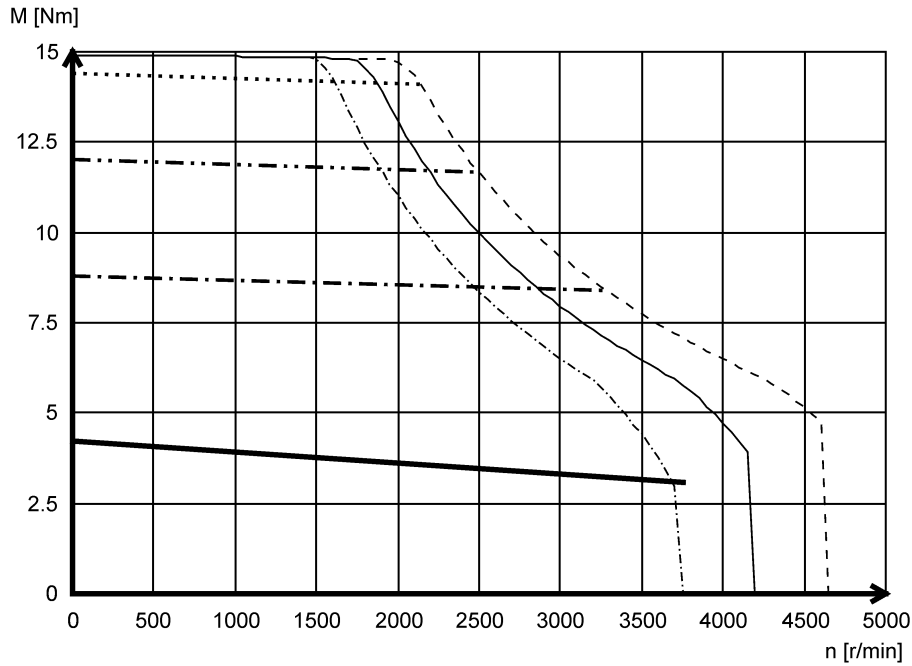

- Mmax 440 V
- Mmax 400 V
- · - · Mmax 360 V
- Mmax @ Imax= 4x I₀
- · · - Mmax @ Imax= 3x I₀
- · - · Mmax @ Imax= 2x I₀
- S1

MCS09F60- (self-ventilated)

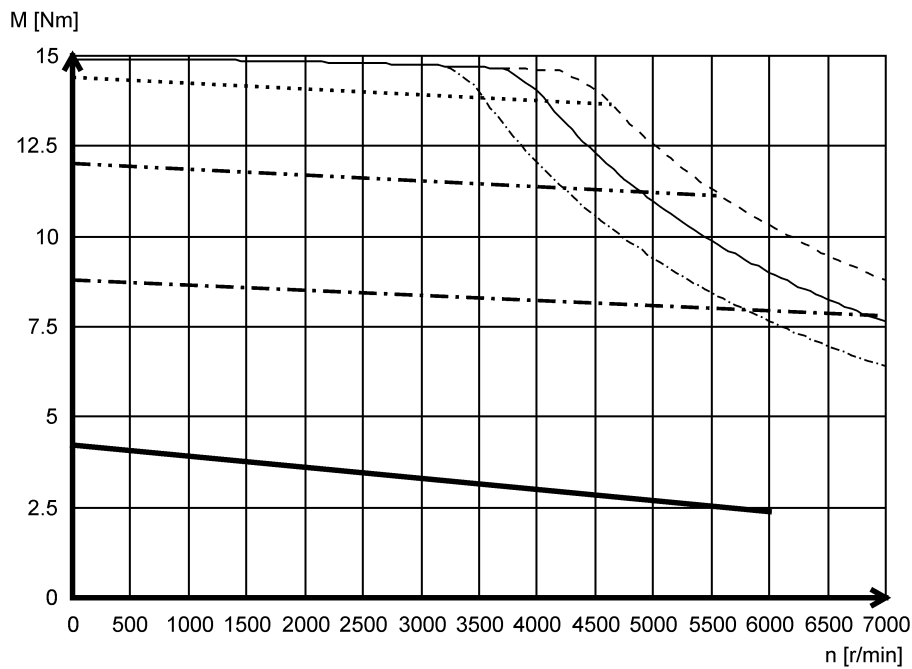

- Mmax 440 V
- Mmax 400 V
- · - · Mmax 360 V
- Mmax @ Imax= 4x I₀
- · · - Mmax @ Imax= 3x I₀
- · - · Mmax @ Imax= 2x I₀
- S1



MCS09H41- (self-ventilated)

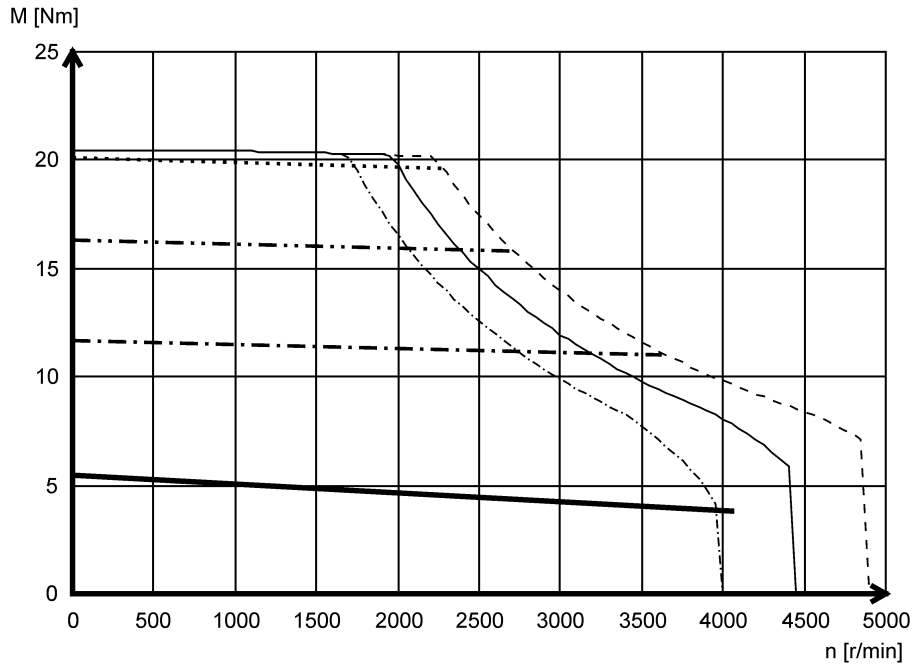

- Mmax 440 V
- Mmax 400 V
- - - - Mmax 360 V
- Mmax @ I_{max}= 4x I₀
- · - · Mmax @ I_{max}= 3x I₀
- · - · Mmax @ I_{max}= 2x I₀
- S1

MCS09H60- (self-ventilated)

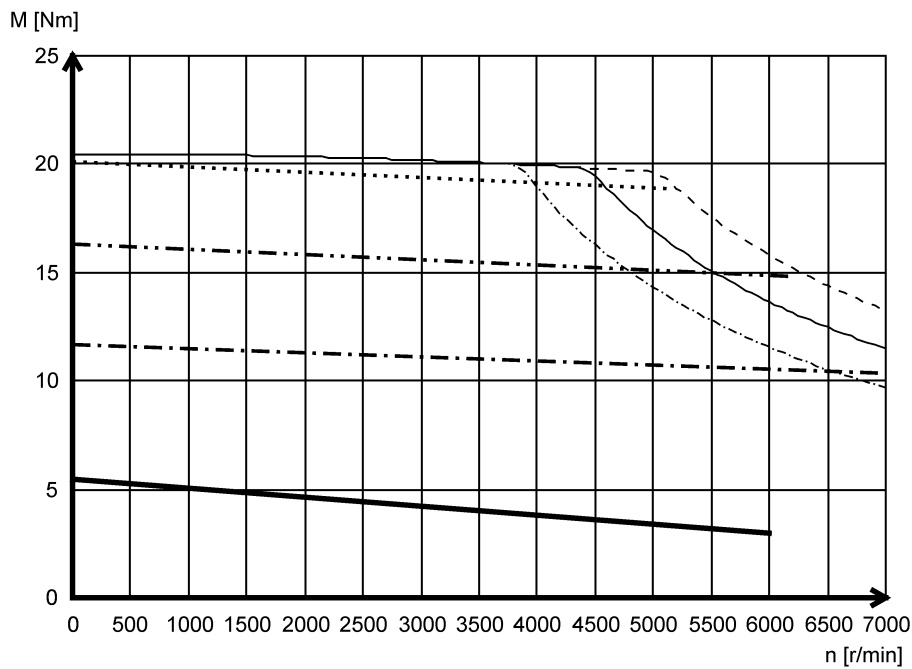

- Mmax 440 V
- Mmax 400 V
- - - - Mmax 360 V
- Mmax @ I_{max}= 4x I₀
- · - · Mmax @ I_{max}= 3x I₀
- · - · Mmax @ I_{max}= 2x I₀
- S1

Technical data

Torque characteristics



MCS09L41- (self-ventilated)

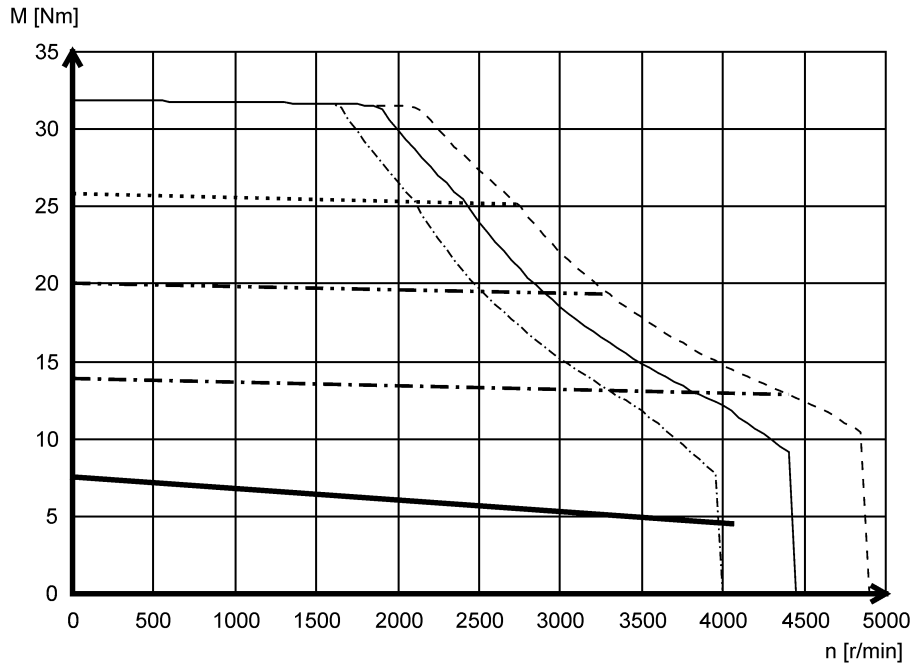

- Mmax 440 V
- _____ Mmax 400 V
- - - - - Mmax 360 V
- Mmax @ I_{max}= 4x I₀
- · - · - Mmax @ I_{max}= 3x I₀
- · - · - Mmax @ I_{max}= 2x I₀
- _____ S1

MCS09L51- (self-ventilated)

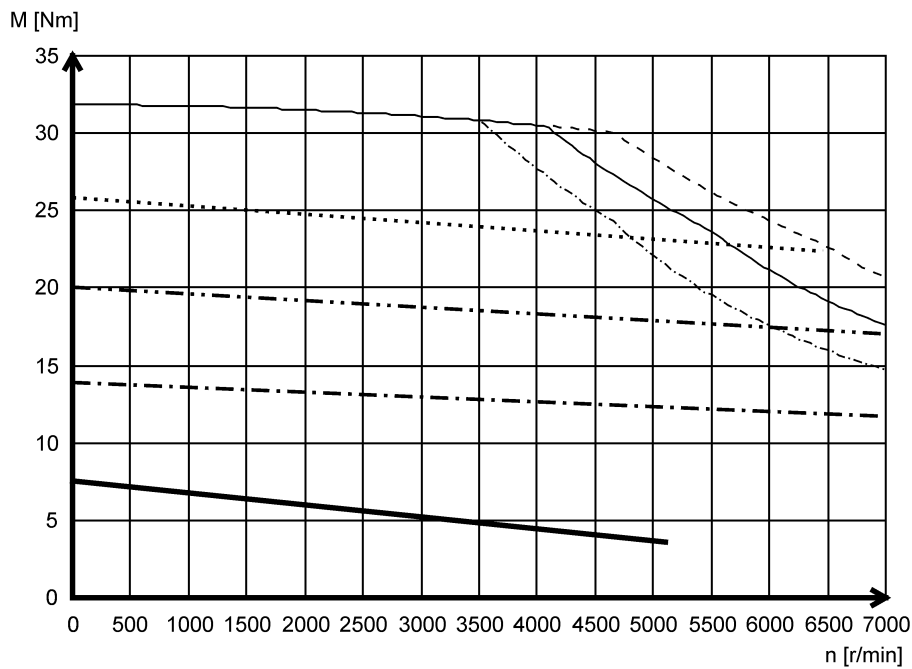

- Mmax 440 V
- _____ Mmax 400 V
- - - - - Mmax 360 V
- Mmax @ I_{max}= 4x I₀
- · - · - Mmax @ I_{max}= 3x I₀
- · - · - Mmax @ I_{max}= 2x I₀
- _____ S1



MCS12D17- (forced ventilated)

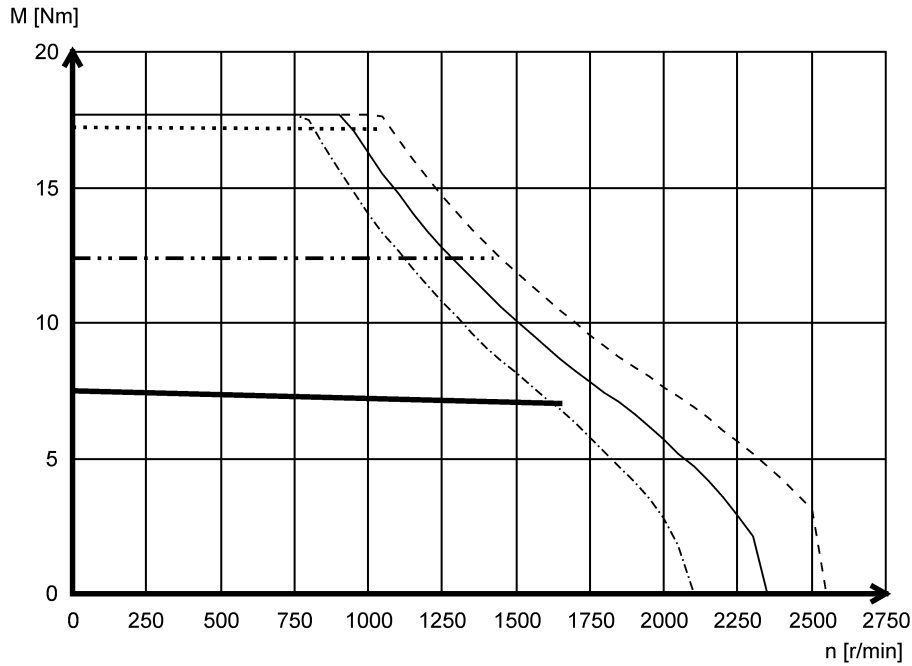

- Mmax 440 V
- Mmax 400 V
- · - · - Mmax 360 V
- Mmax @ I_{max}= 3x I₀
- · · - Mmax @ I_{max}= 2x I₀
- S1

MCS12D20- (self-ventilated)

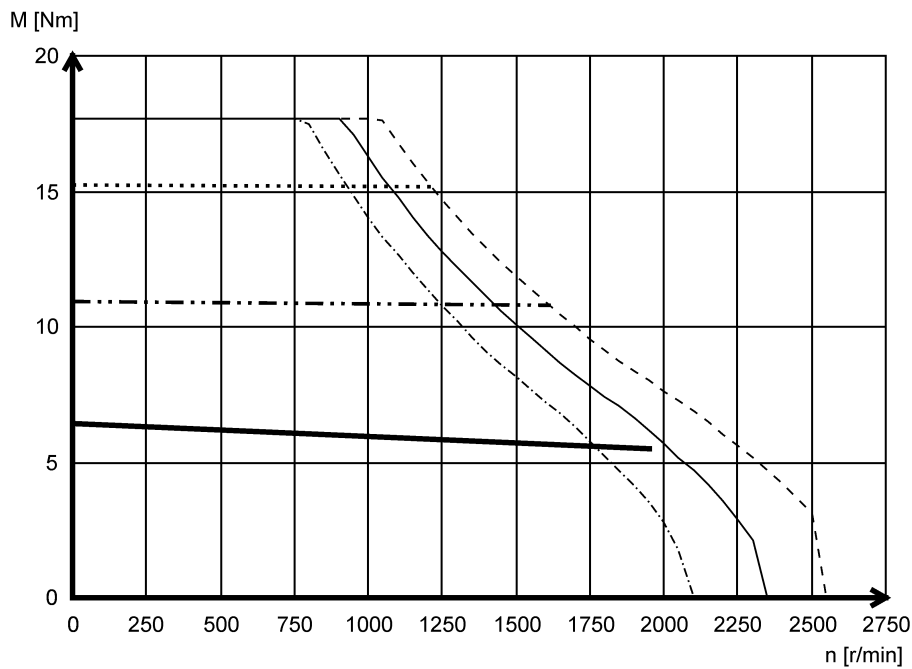

- Mmax 440 V
- Mmax 400 V
- · - · - Mmax 360 V
- Mmax @ I_{max}= 3x I₀
- · · - Mmax @ I_{max}= 2x I₀
- S1

Technical data

Torque characteristics



MCS12D35- (forced ventilated)

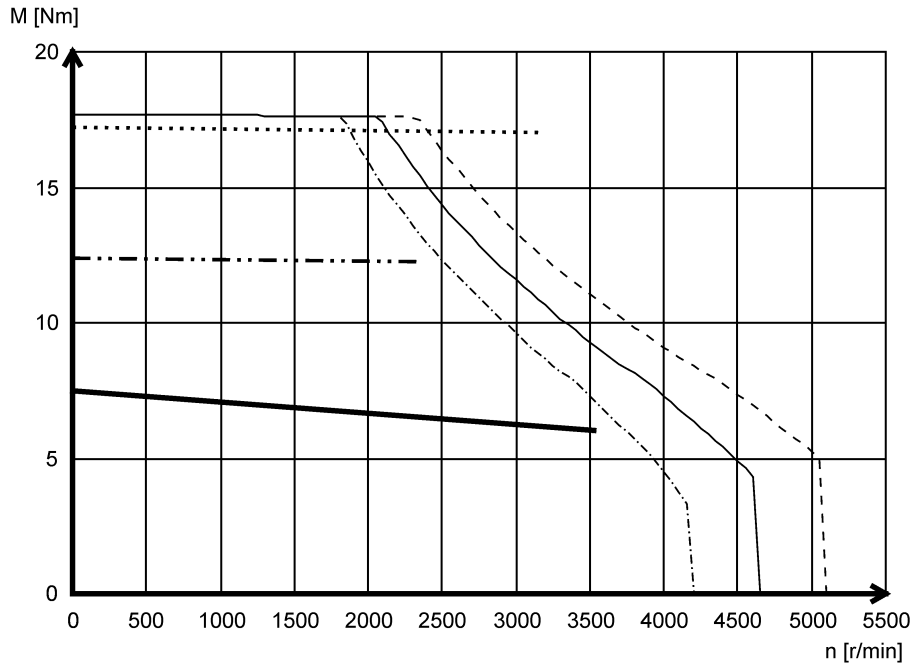

- Mmax 440 V
- Mmax 400 V
- · - · Mmax 360 V
- Mmax @ Imax= 3x I0
- · · - Mmax @ Imax= 2x I0
- S1

MCS12D41- (self-ventilated)

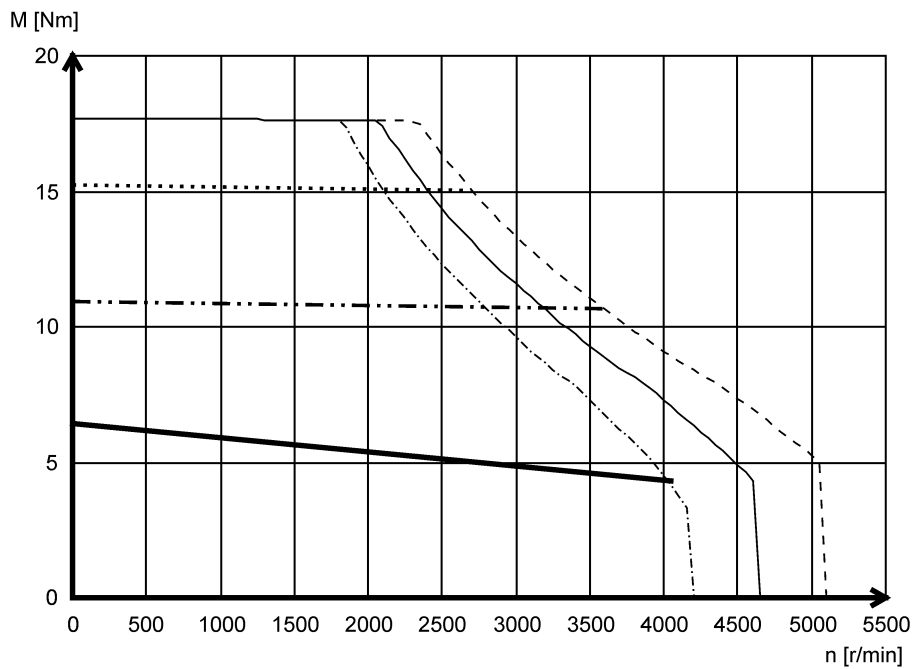

- Mmax 440 V
- Mmax 400 V
- · - · Mmax 360 V
- Mmax @ Imax= 3x I0
- · · - Mmax @ Imax= 2x I0
- S1



MCS12H14- (forced ventilated)

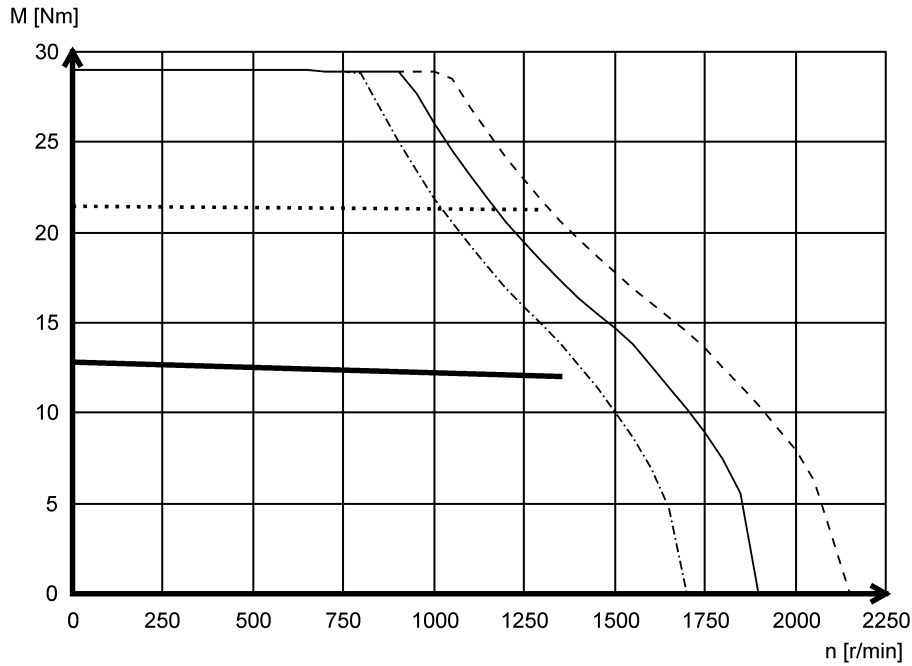

- Mmax 440 V
- Mmax 400 V
- · - · Mmax 360 V
- Mmax @ Imax= 2x I0
- S1

MCS12H15- (self-ventilated)

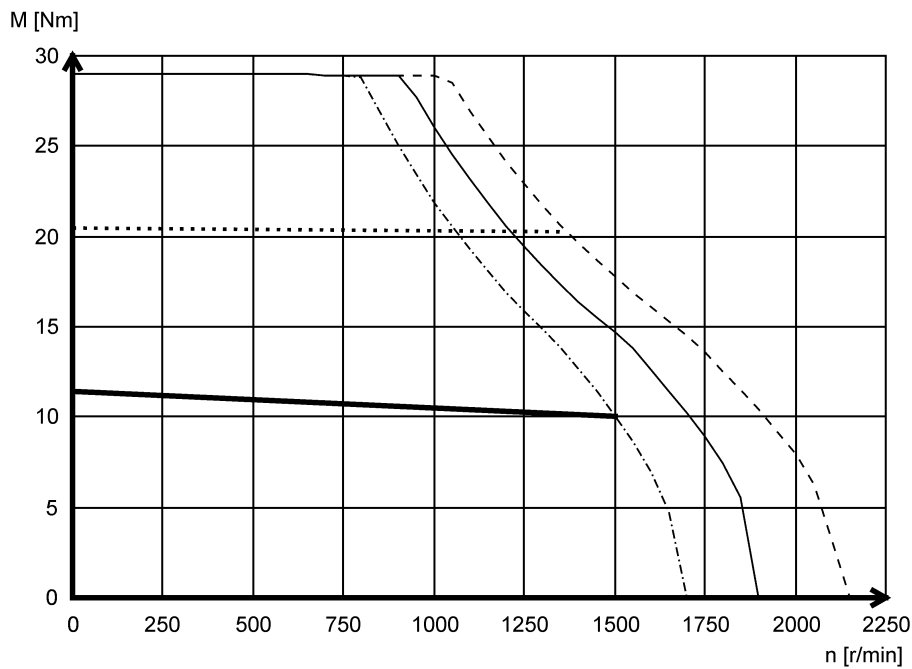

- Mmax 440 V
- Mmax 400 V
- · - · Mmax 360 V
- Mmax @ Imax= 2x I0
- S1

Technical data

Torque characteristics



MCS12H34- (forced ventilated)

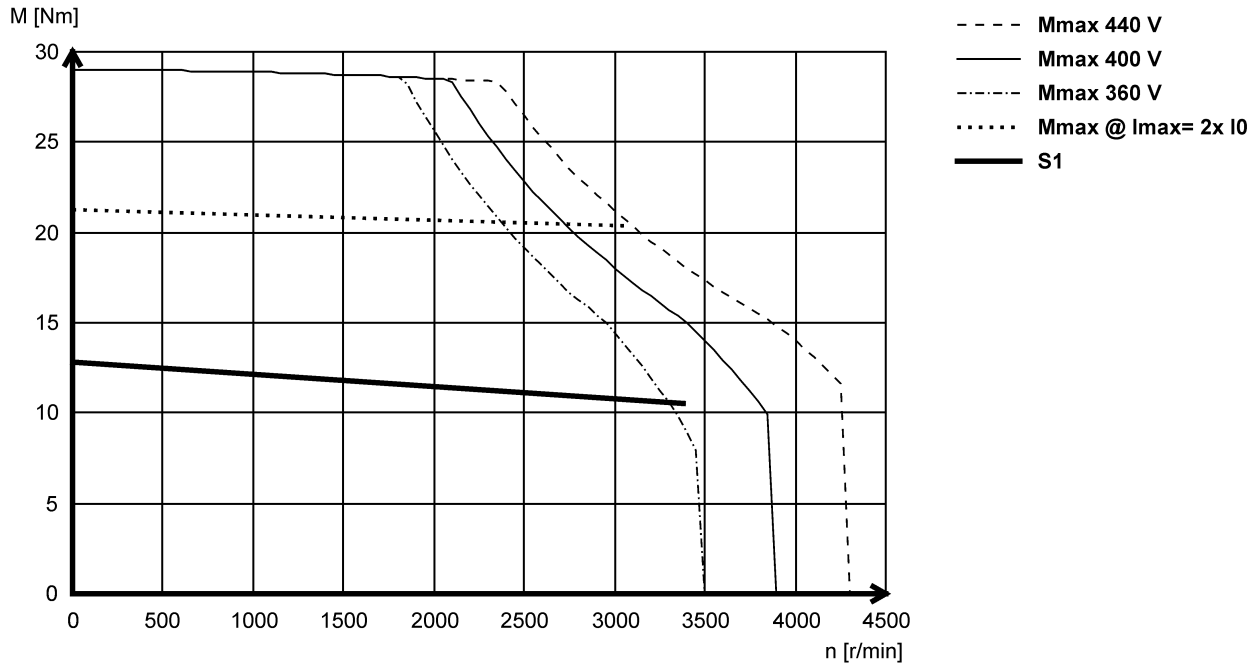

MCS12H35- (self-ventilated)

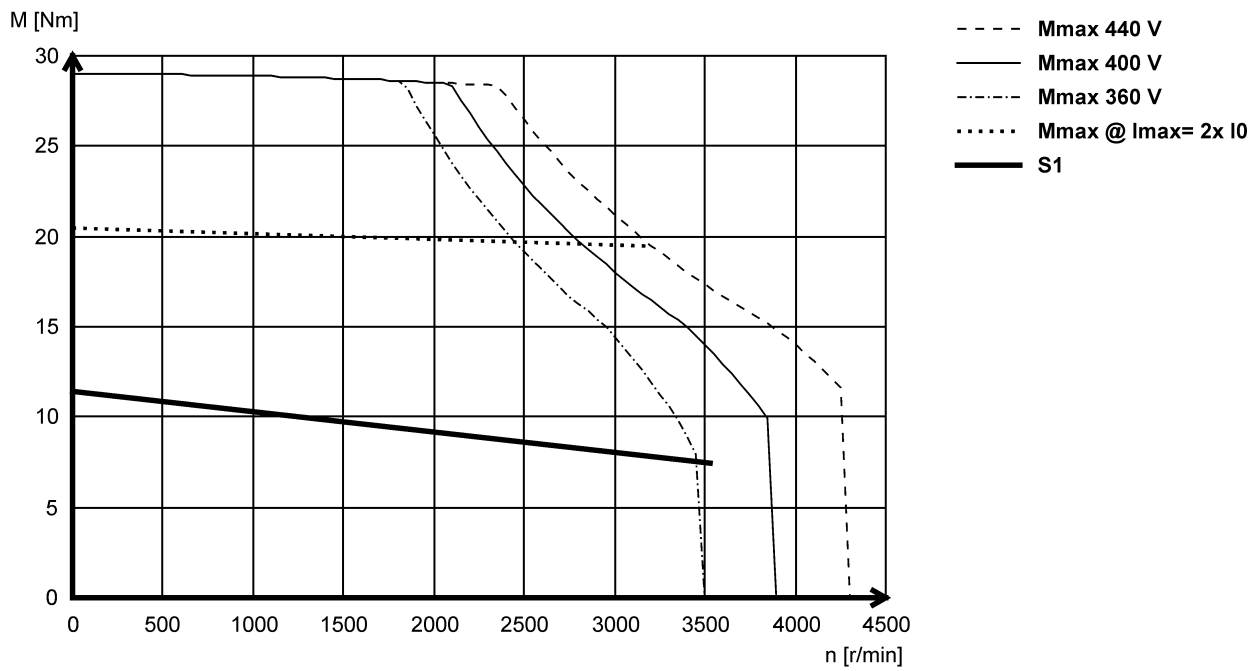



MCS12L17- (forced ventilated)

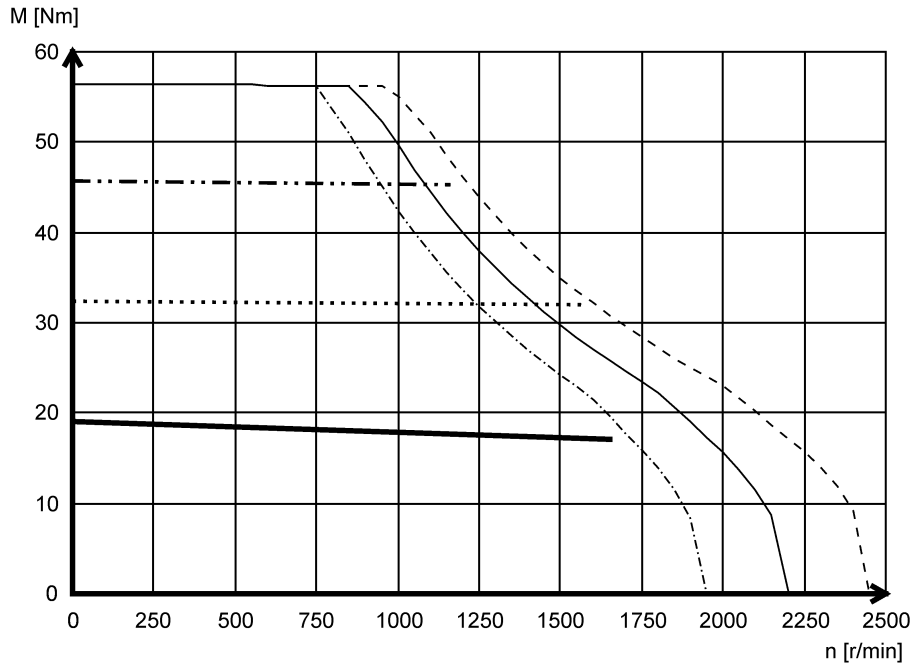

- Mmax 440 V
- Mmax 400 V
- · - · Mmax 360 V
- Mmax @ Imax= 3x I0
- · · - Mmax @ Imax= 2x I0
- S1

MCS12L20- (self-ventilated)

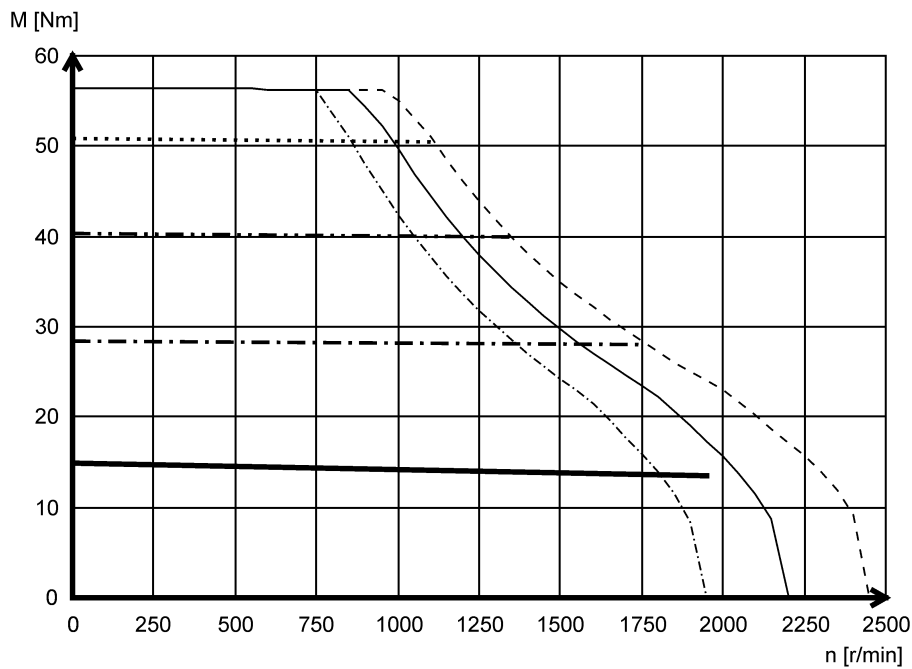

- Mmax 440 V
- Mmax 400 V
- · - · Mmax 360 V
- Mmax @ Imax= 4x I0
- · · - Mmax @ Imax= 3x I0
- · - Mmax @ Imax= 2x I0
- S1

Technical data

Torque characteristics



MCS12L39- (forced ventilated)

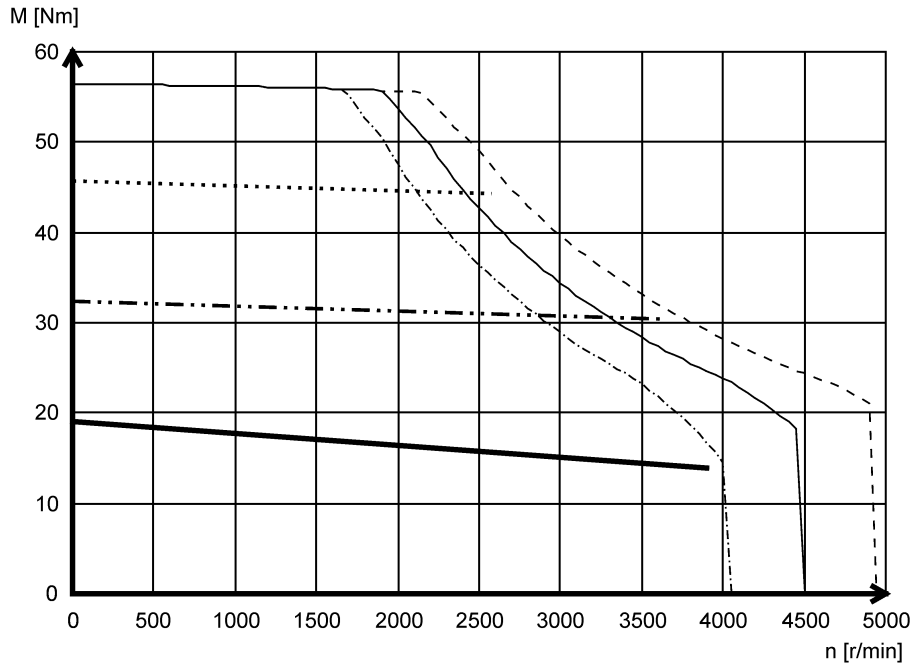

- Mmax 440 V
- Mmax 400 V
- · - · Mmax 360 V
- Mmax @ Imax= 3x I0
- · · - Mmax @ Imax= 2x I0
- S1

MCS12L41- (self-ventilated)

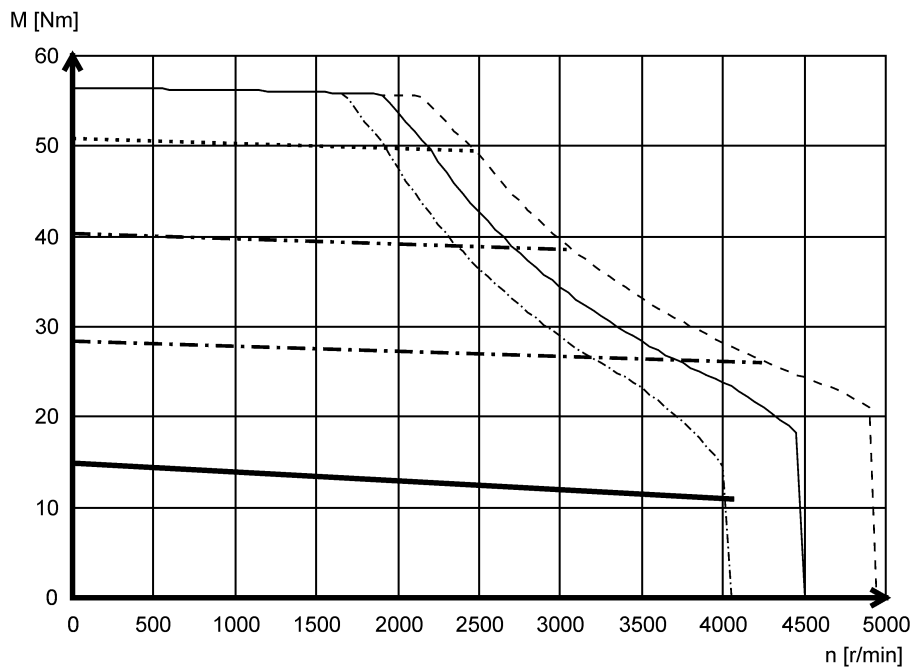

- Mmax 440 V
- Mmax 400 V
- · - · Mmax 360 V
- Mmax @ Imax= 4x I0
- · · - Mmax @ Imax= 3x I0
- · - · Mmax @ Imax= 2x I0
- S1



MCS14D14- (forced ventilated)

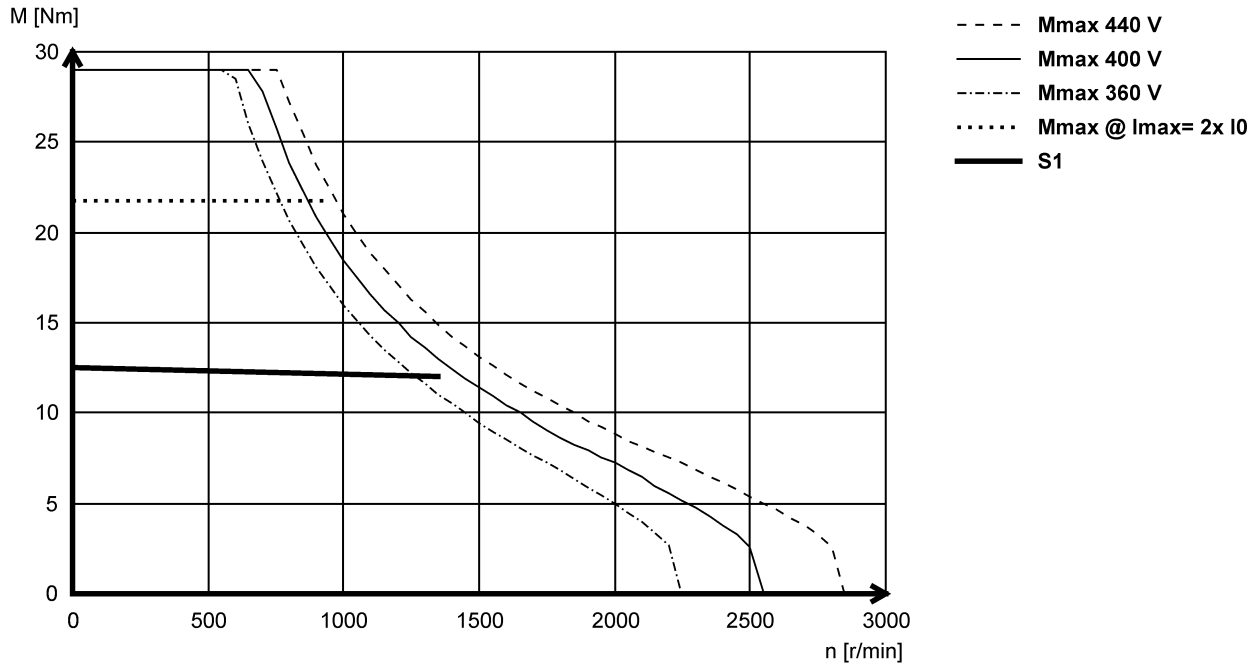

MCS14D15- (self-ventilated)

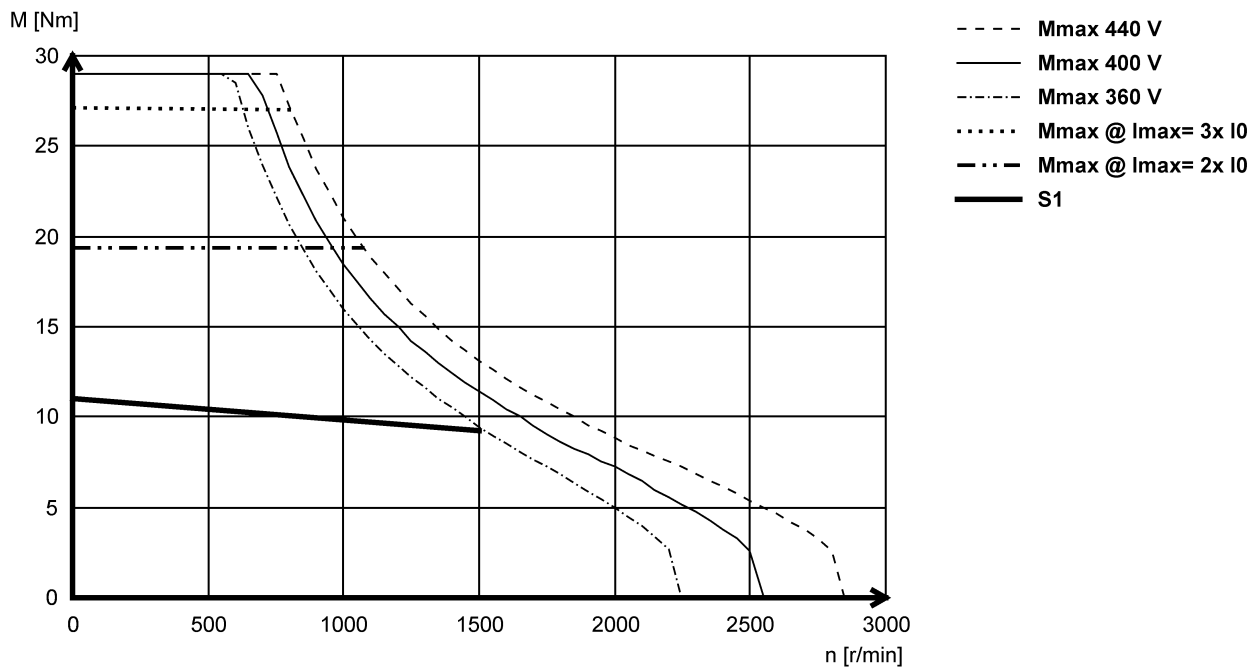

Technical data

Torque characteristics



MCS14D30- (forced ventilated)

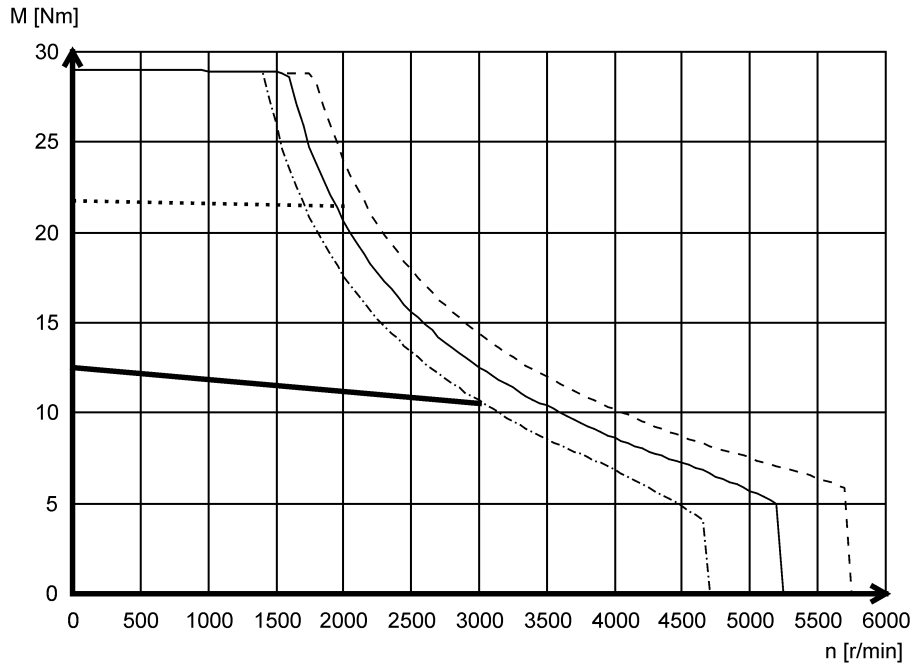

- Mmax 440 V
- _____ Mmax 400 V
- - - - - Mmax 360 V
- Mmax @ Imax= 2x I0
- S1

MCS14D36- (self-ventilated)

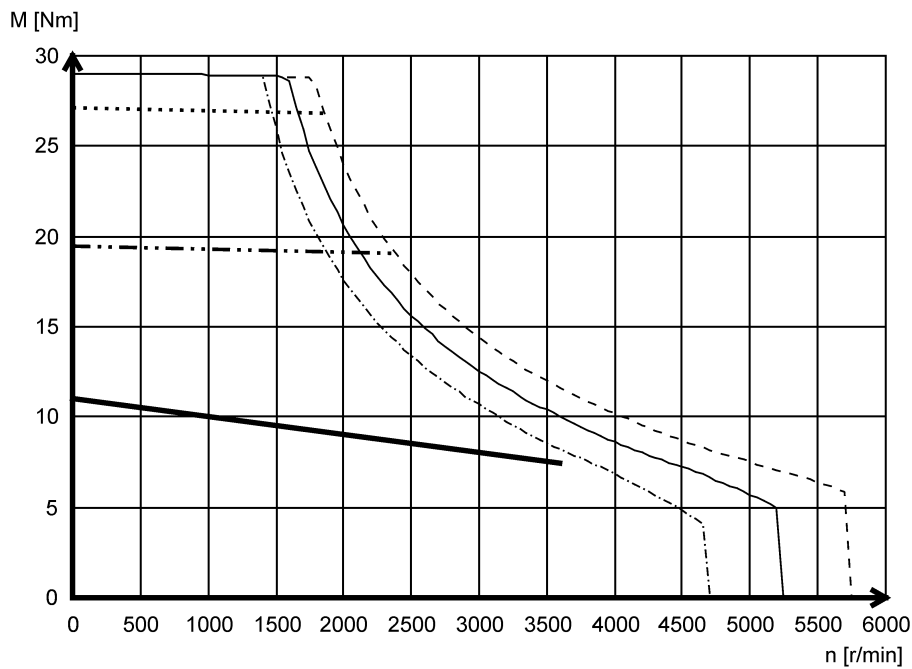

- Mmax 440 V
- _____ Mmax 400 V
- - - - - Mmax 360 V
- Mmax @ Imax= 3x I0
- . - . - Mmax @ Imax= 2x I0
- S1



MCS14H12- (forced ventilated)

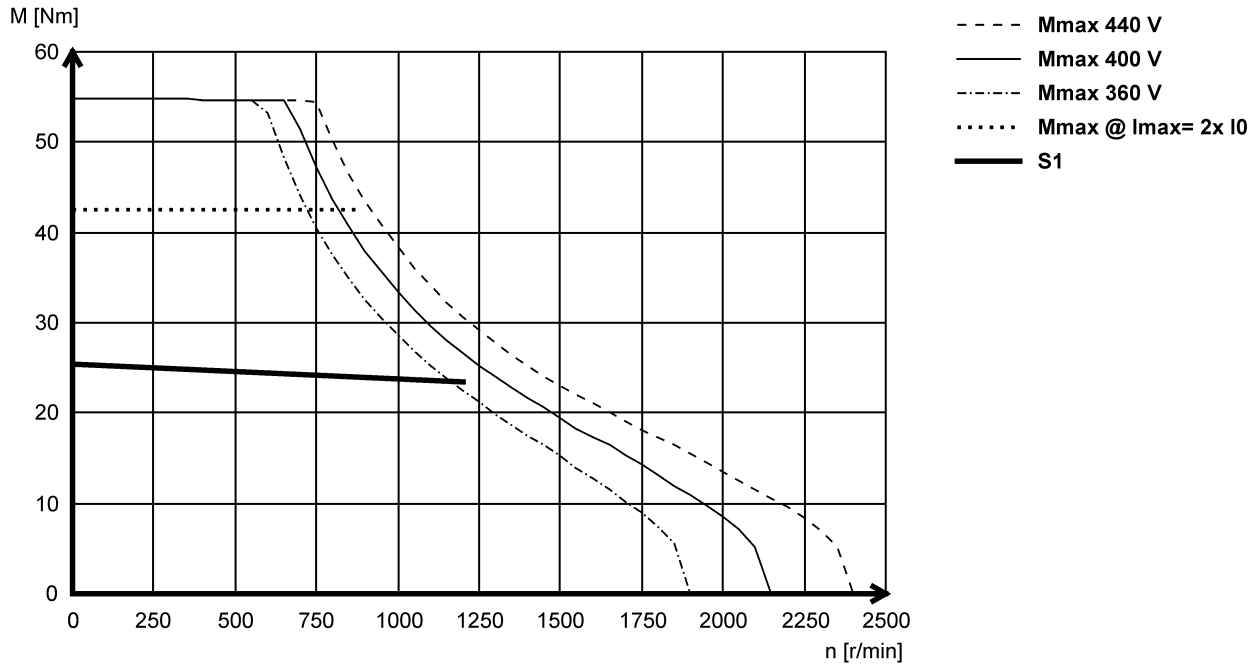

MCS14H15- (self-ventilated)

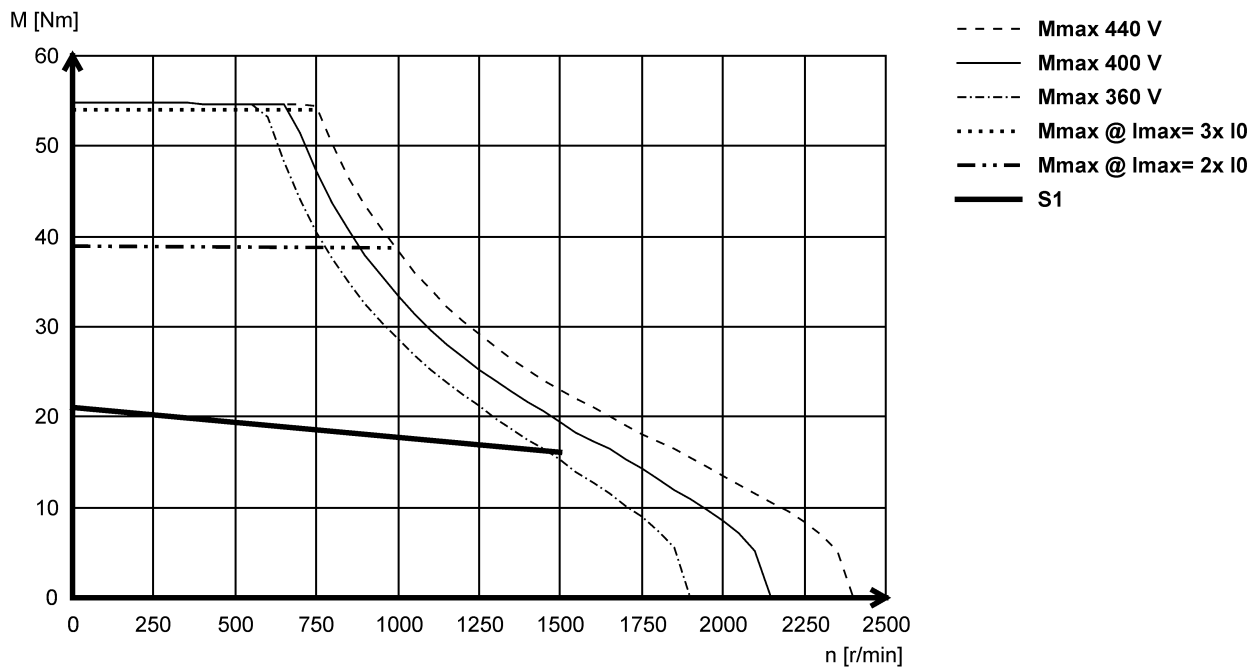

Technical data

Torque characteristics



MCS14H28- (forced ventilated)

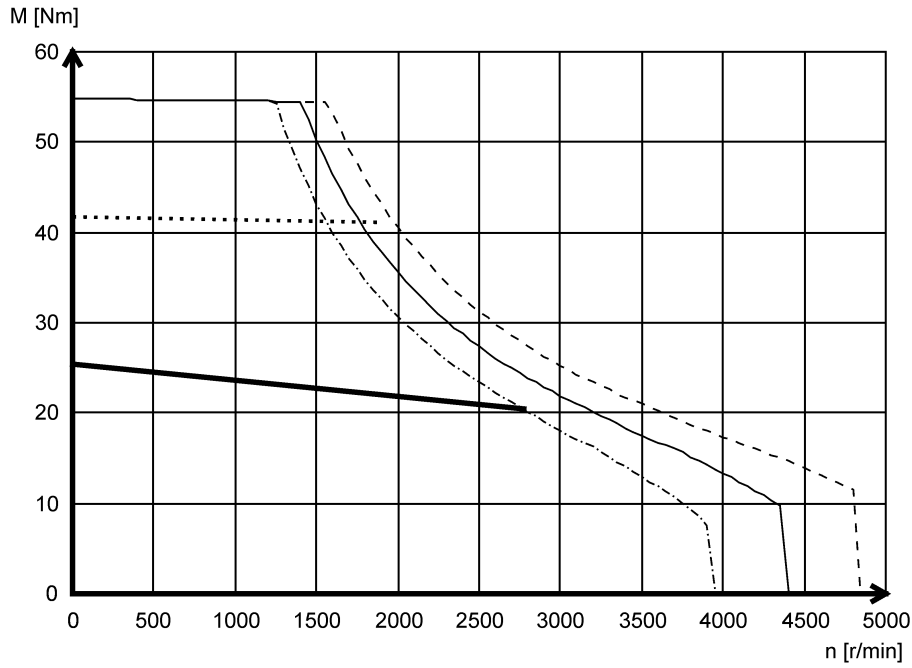

- Mmax 440 V
- Mmax 400 V
- · - · Mmax 360 V
- Mmax @ Imax= 2x I0
- S1

MCS14H32- (self-ventilated)

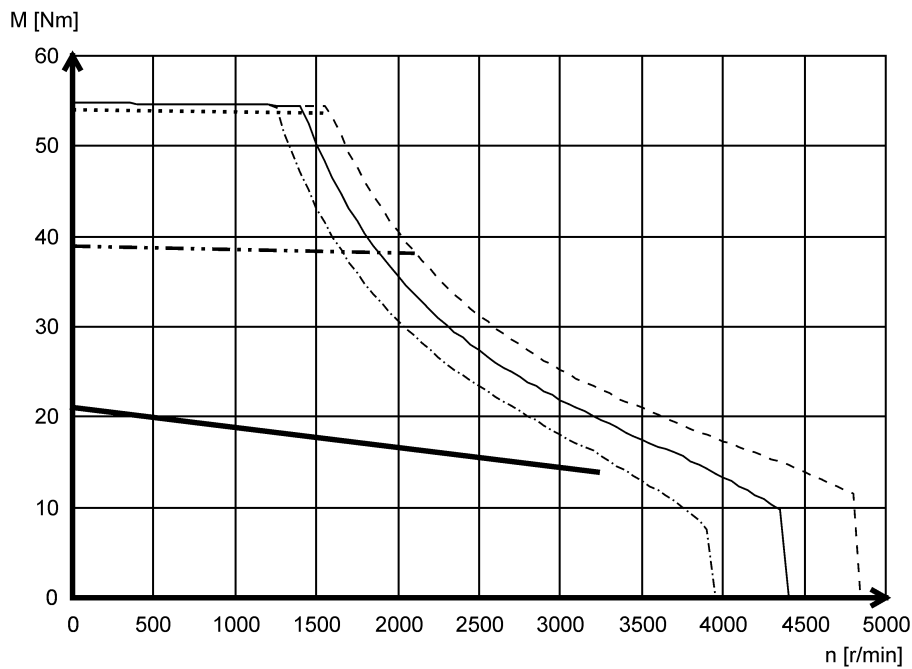

- Mmax 440 V
- Mmax 400 V
- · - · Mmax 360 V
- Mmax @ Imax= 3x I0
- · - · Mmax @ Imax= 2x I0
- S1



Technical data

Torque characteristics

MCS14L14- (forced ventilated)

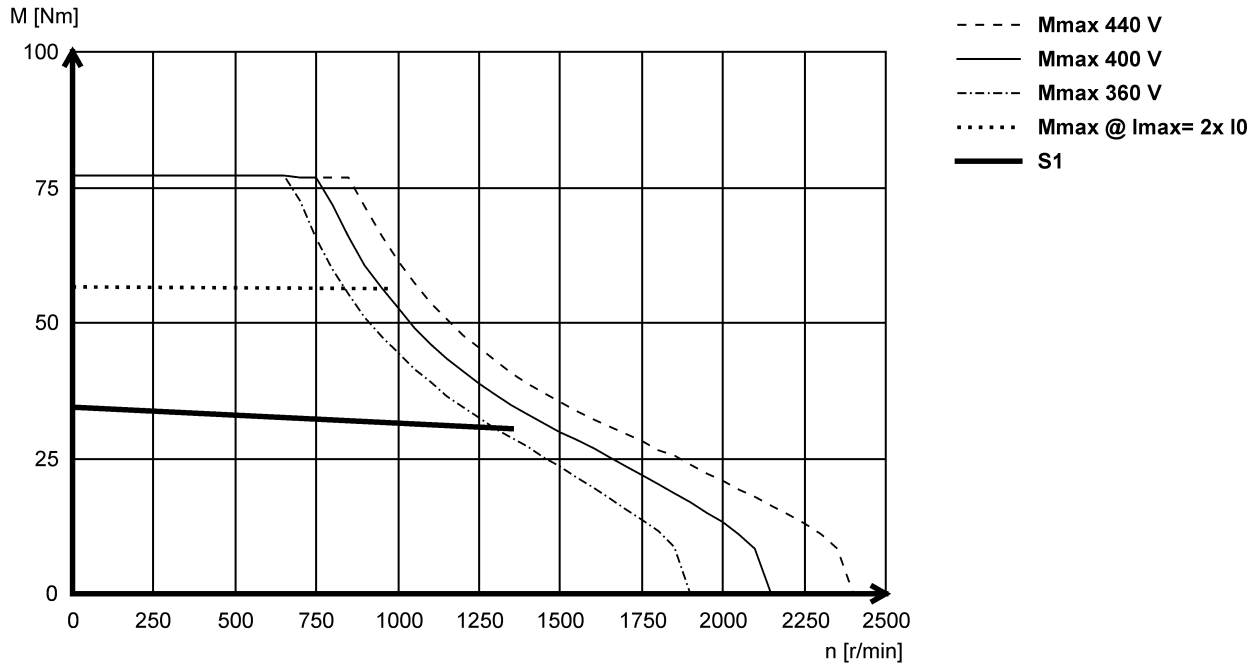

MCS14L15- (self-ventilated)

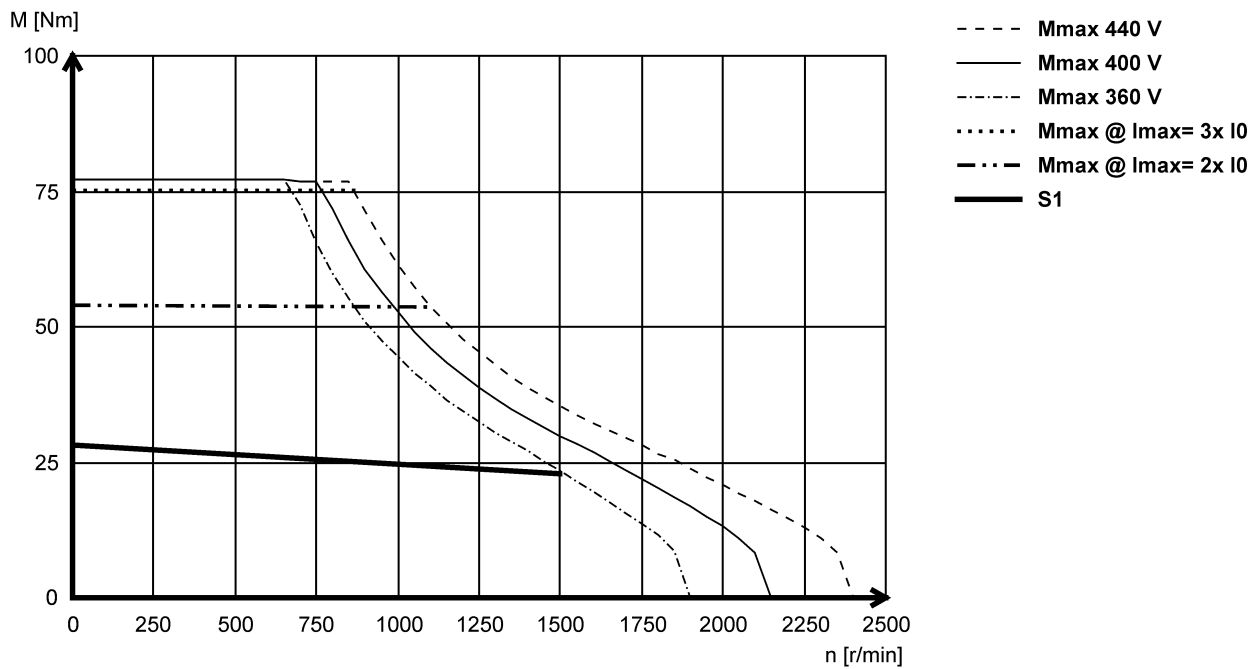

Technical data

Torque characteristics



MCS14L30- (forced ventilated)

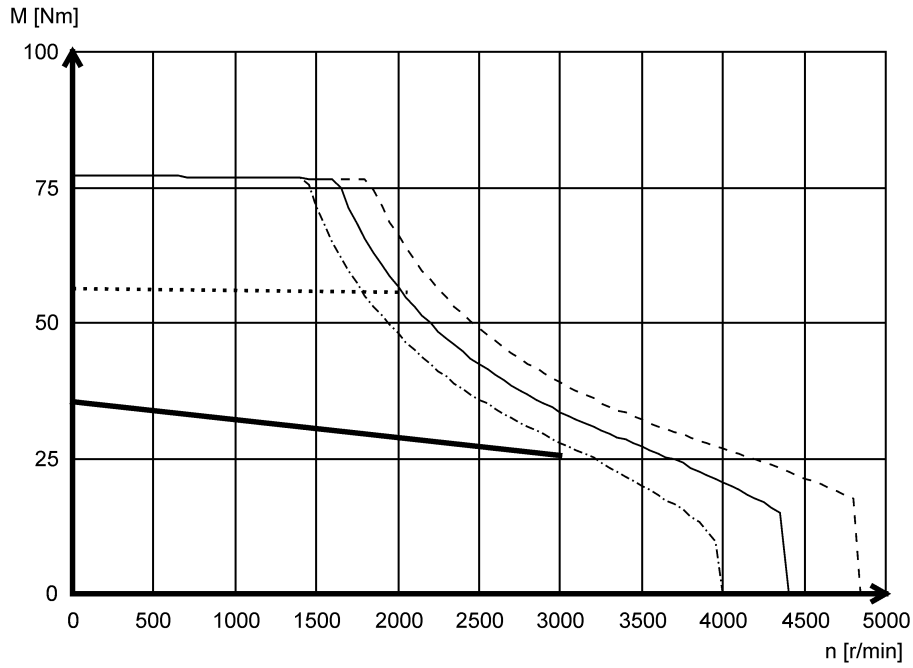

MCS14L32- (self-ventilated)

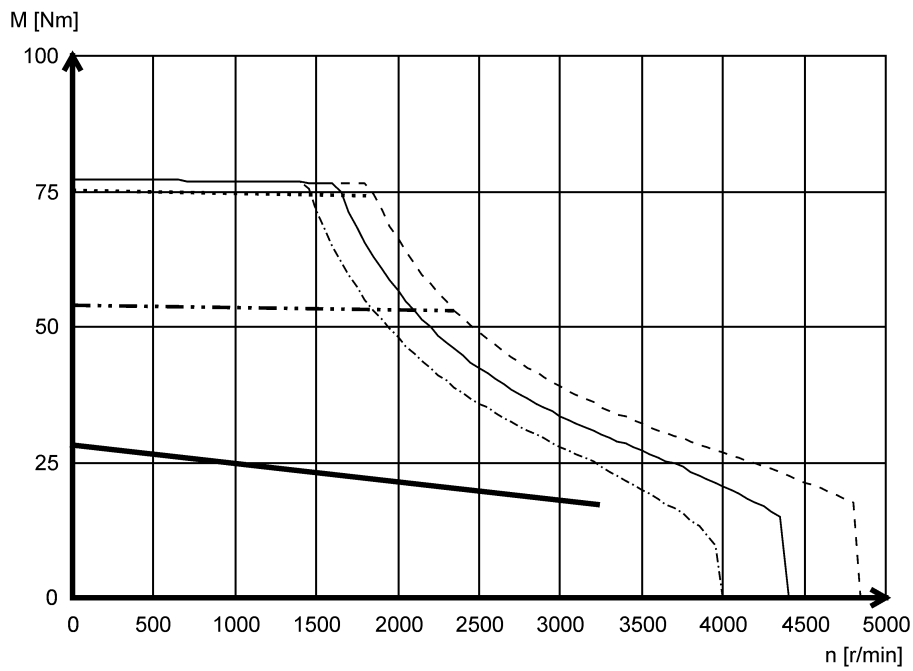



Technical data

Torque characteristics

MCS14P11- (forced ventilated)

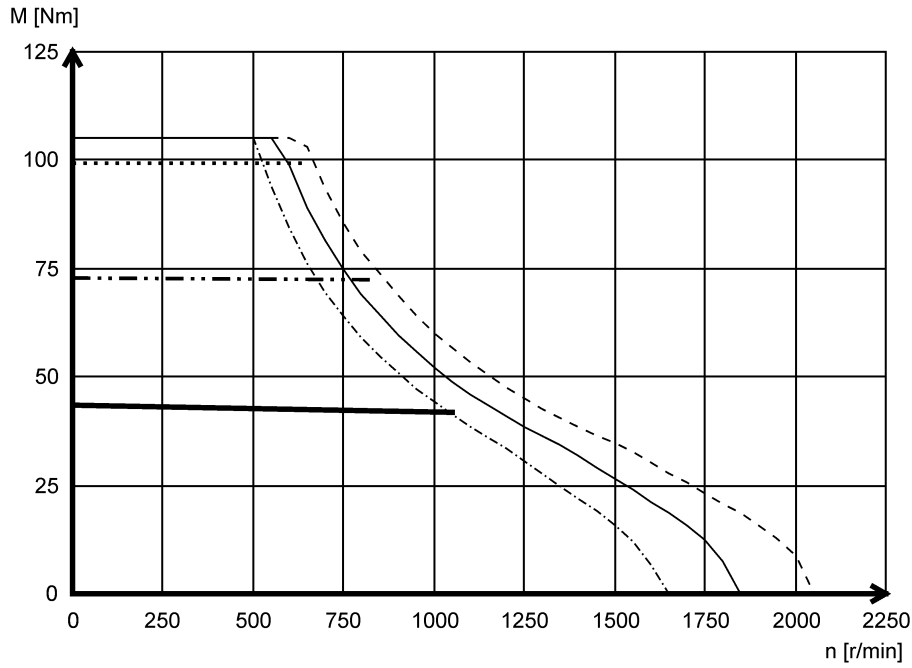

- Mmax 440 V
- Mmax 400 V
- - - - Mmax 360 V
- Mmax @ Imax= 3x I0
- · - · Mmax @ Imax= 2x I0
- S1

MCS14P14- (self-ventilated)

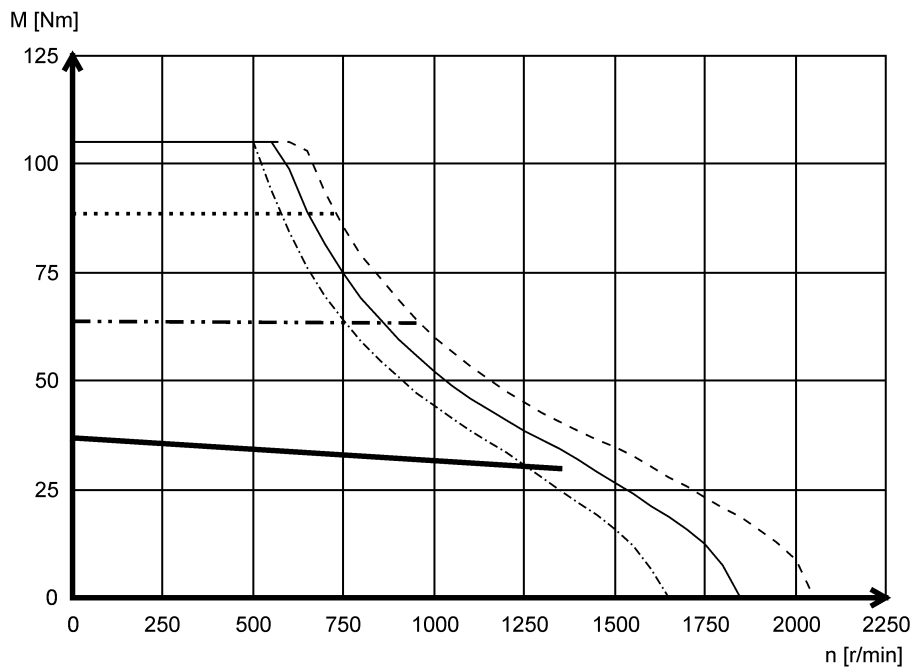

- Mmax 440 V
- Mmax 400 V
- - - - Mmax 360 V
- Mmax @ Imax= 3x I0
- · - · Mmax @ Imax= 2x I0
- S1

Technical data

Torque characteristics



MCS14P26- (forced ventilated)

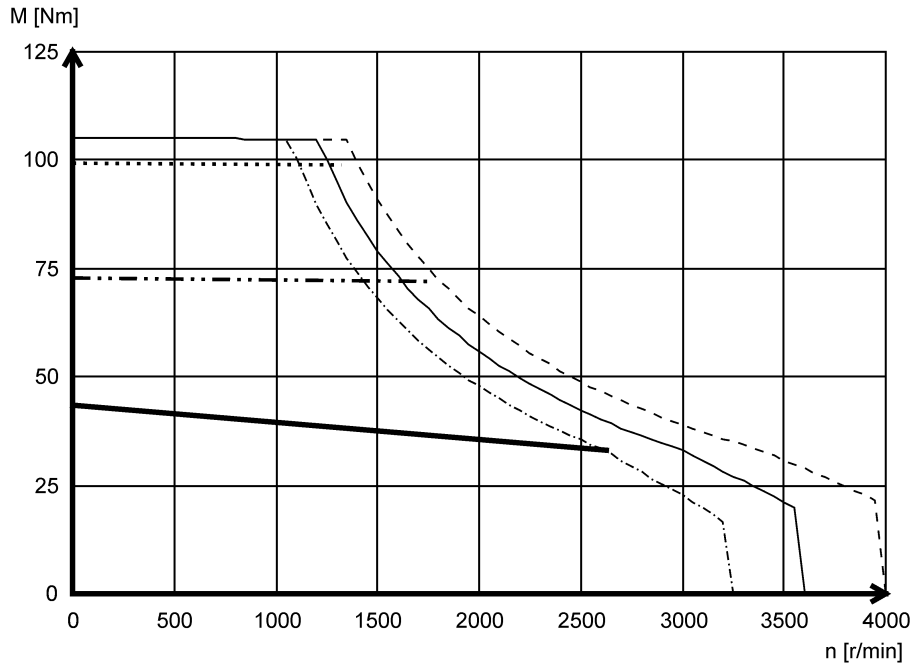

- Mmax 440 V
- Mmax 400 V
- - - - Mmax 360 V
- Mmax @ Imax= 3x I0
- · - · Mmax @ Imax= 2x I0
- S1

MCS14P32- (self-ventilated)

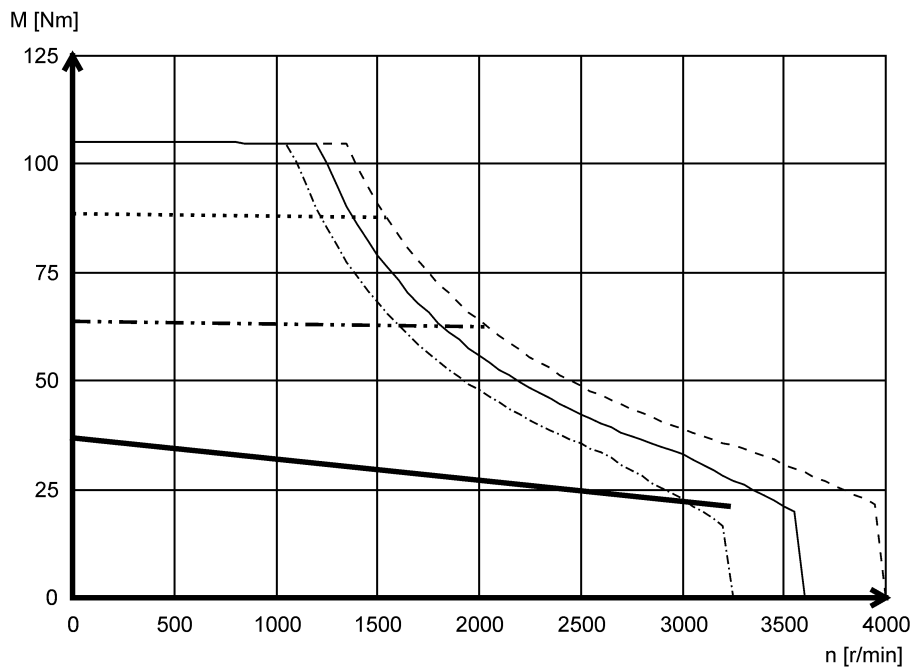

- Mmax 440 V
- Mmax 400 V
- - - - Mmax 360 V
- Mmax @ Imax= 3x I0
- · - · Mmax @ Imax= 2x I0
- S1



Technical data

Torque characteristics

MCS19F12- (forced ventilated)

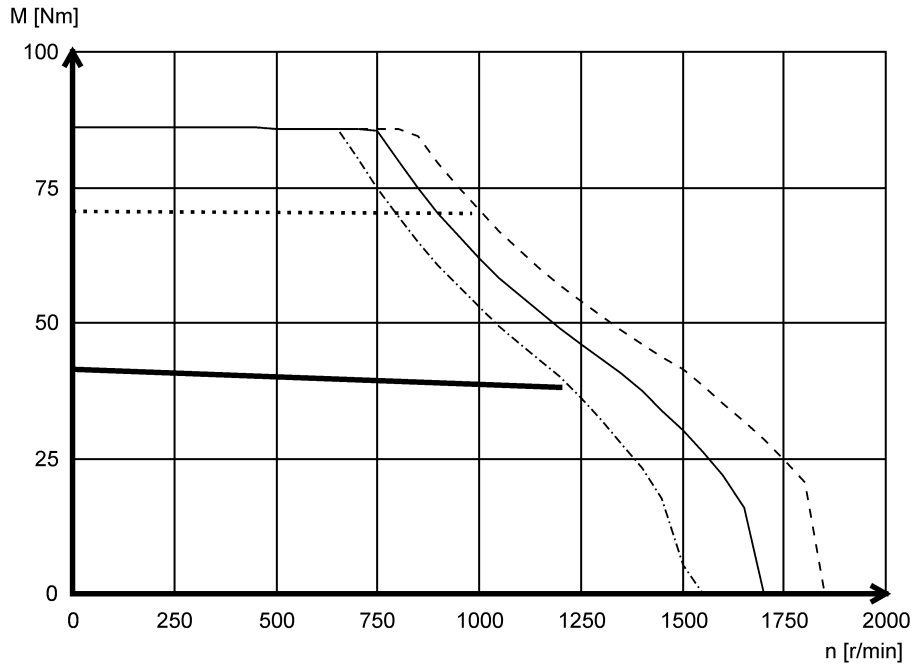

- Mmax 440 V
- Mmax 400 V
- · - · Mmax 360 V
- Mmax @ Imax= 2x I0
- S1

MCS19F14- (self-ventilated)

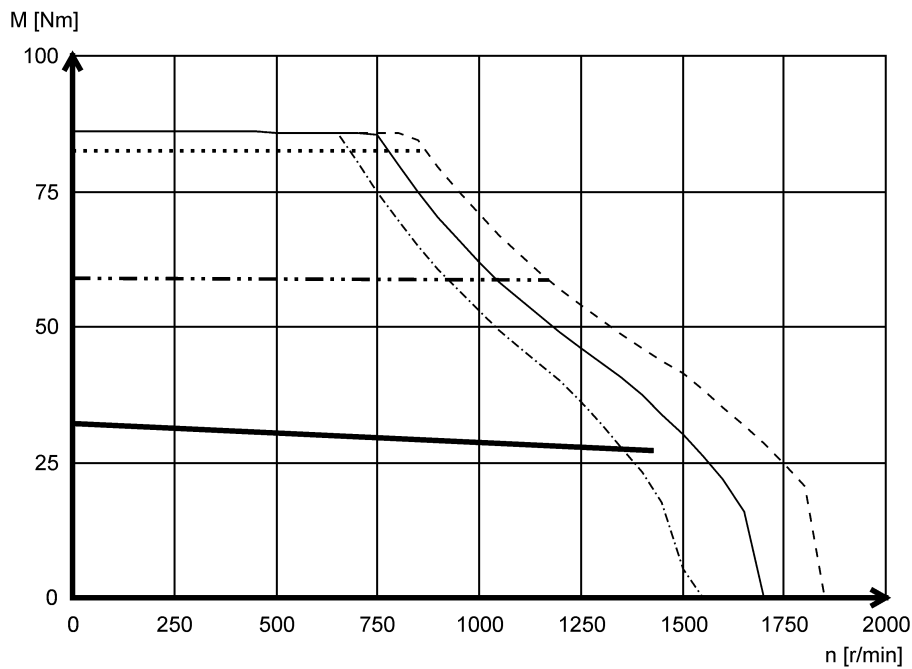

- Mmax 440 V
- Mmax 400 V
- · - · Mmax 360 V
- Mmax @ Imax= 3x I0
- · - · - Mmax @ Imax= 2x I0
- S1

Technical data

Torque characteristics



MCS19F29- (forced ventilated)

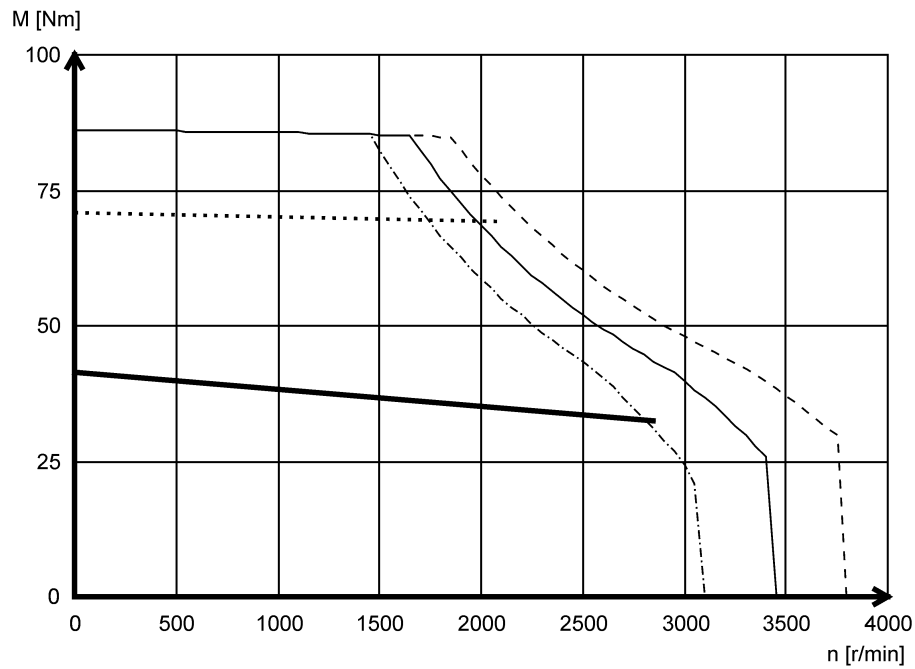

- Mmax 440 V
- Mmax 400 V
- · - · Mmax 360 V
- Mmax @ Imax= 2x I0
- S1

MCS19F30- (self-ventilated)

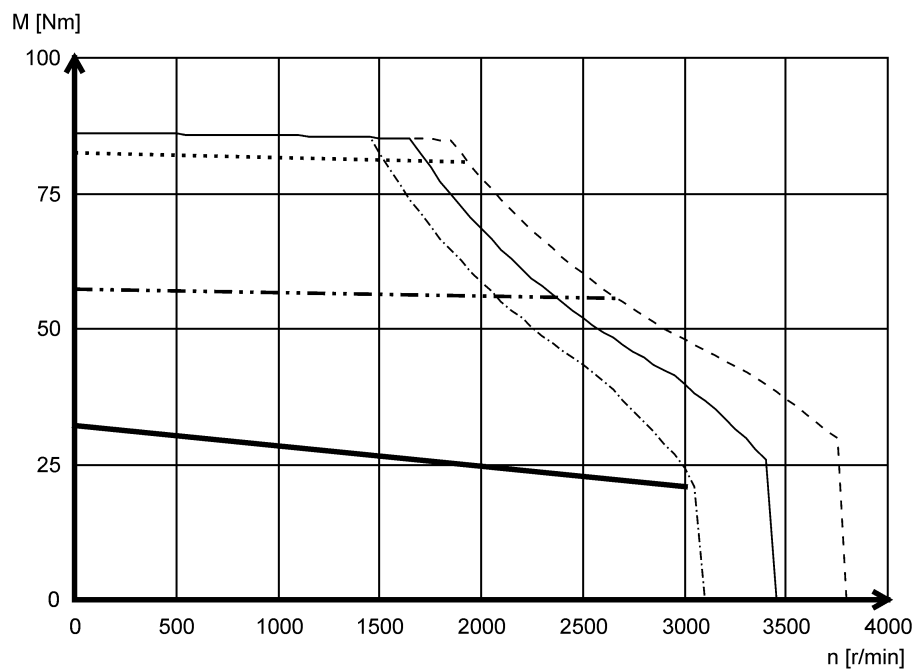

- Mmax 440 V
- Mmax 400 V
- · - · Mmax 360 V
- Mmax @ Imax= 3x I0
- · - · Mmax @ Imax= 2x I0
- S1



MCS19J12- (forced ventilated)

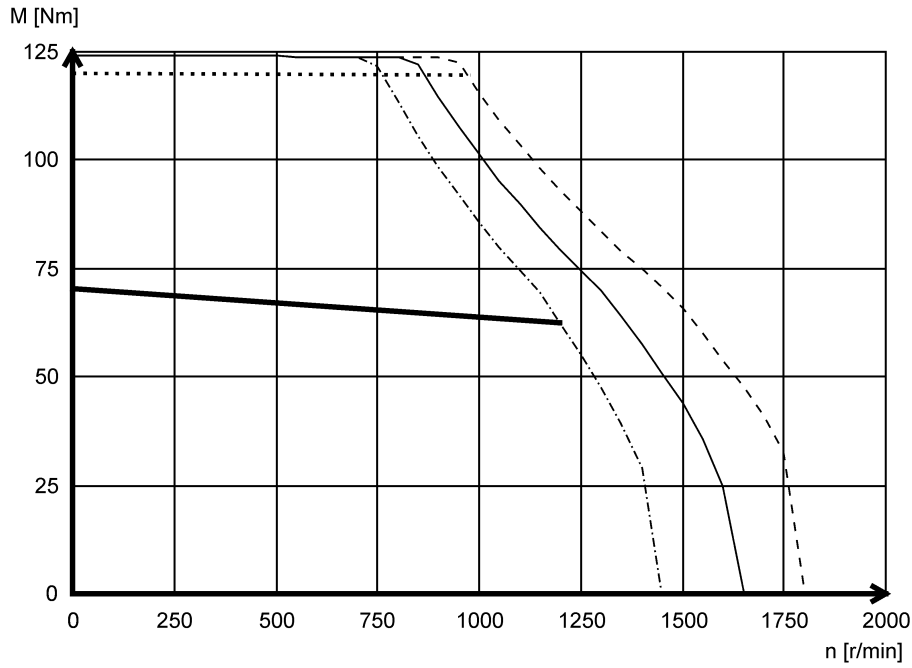

- Mmax 440 V
- Mmax 400 V
- · - · Mmax 360 V
- Mmax @ Imax= 2x I0
- S1

MCS19J14- (self-ventilated)

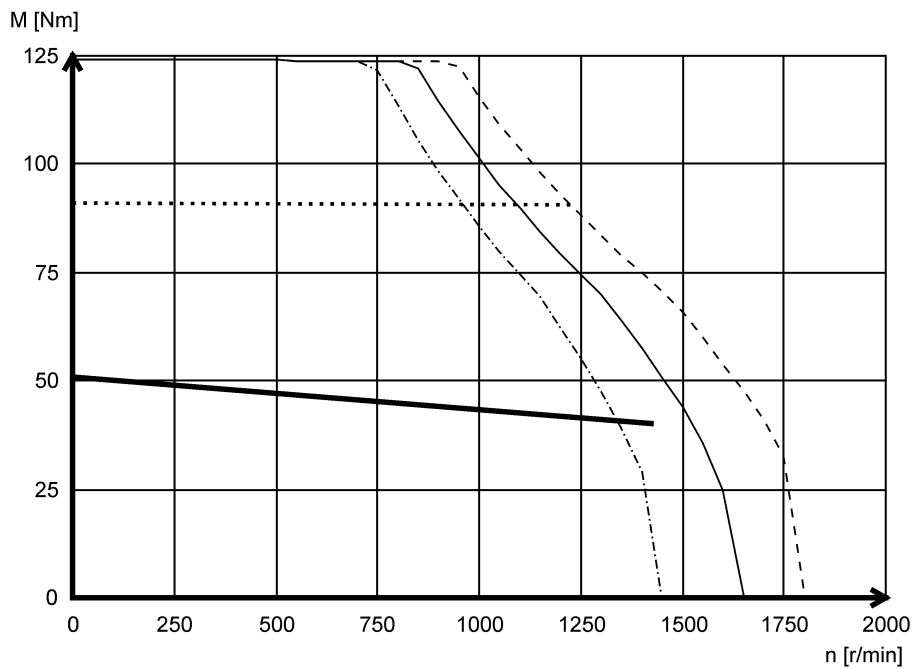

- Mmax 440 V
- Mmax 400 V
- · - · Mmax 360 V
- Mmax @ Imax= 2x I0
- S1

Technical data

Torque characteristics



MCS19J29- (forced ventilated)

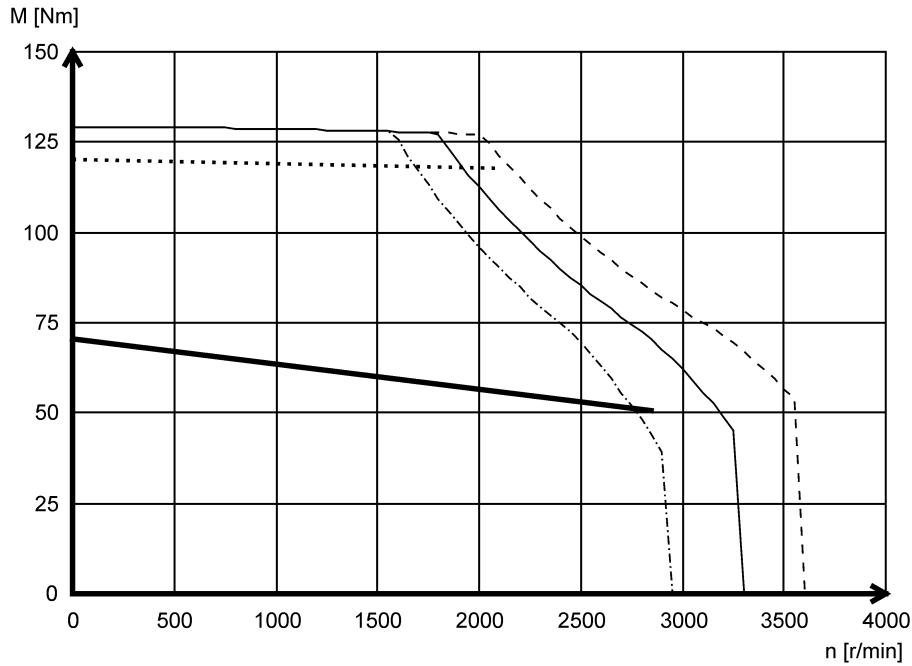

- Mmax 440 V
- Mmax 400 V
- · - · Mmax 360 V
- Mmax @ Imax= 2x I0
- S1

MCS19J30- (self-ventilated)

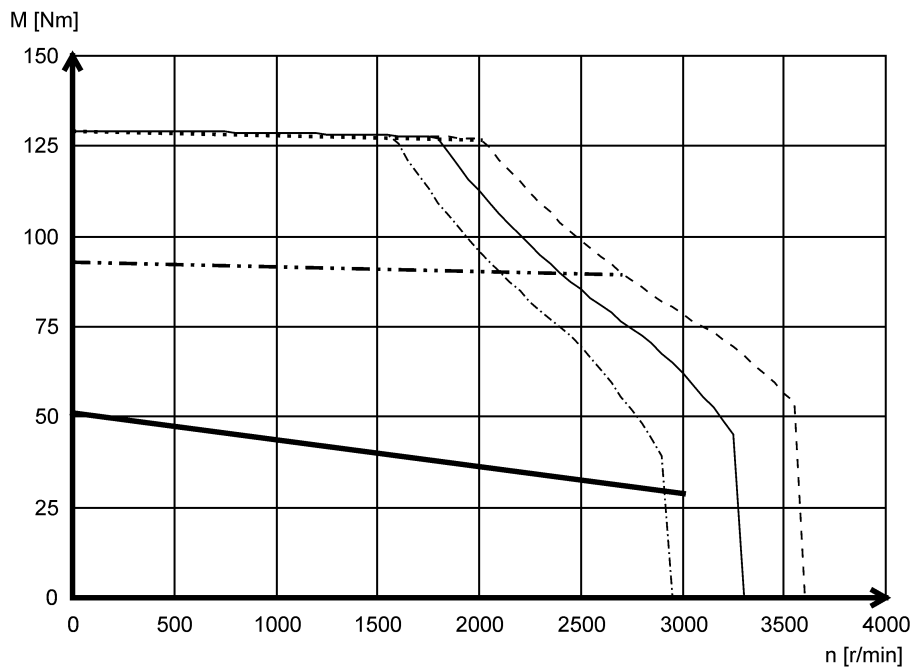

- Mmax 440 V
- Mmax 400 V
- · - · Mmax 360 V
- Mmax @ Imax= 3x I0
- · - · Mmax @ Imax= 2x I0
- S1



Technical data

Torque characteristics

MCS19P12- (forced ventilated)

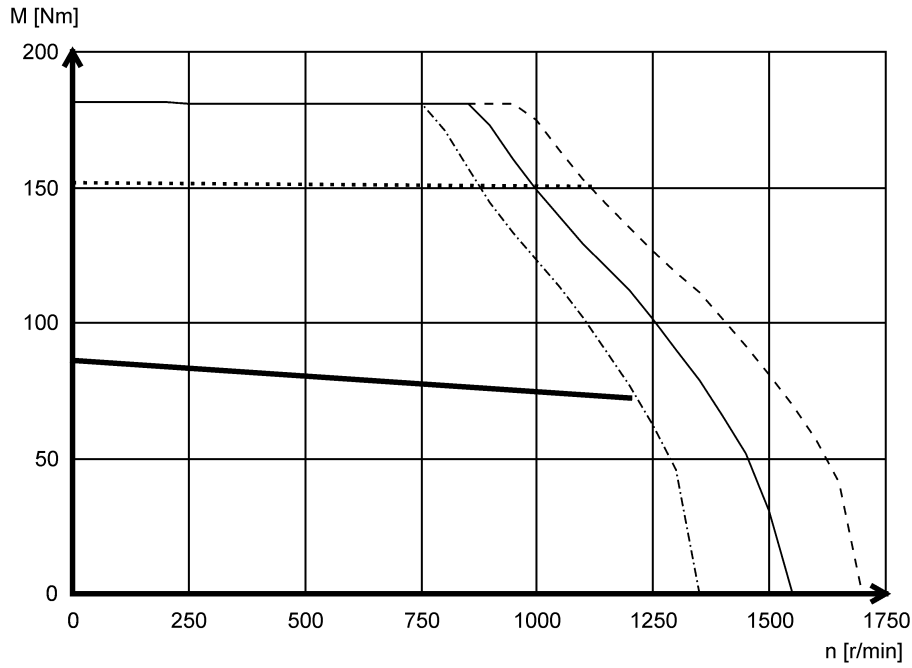

- Mmax 440 V
- Mmax 400 V
- · - · Mmax 360 V
- Mmax @ Imax= 2x I0
- S1

MCS19P14- (self-ventilated)

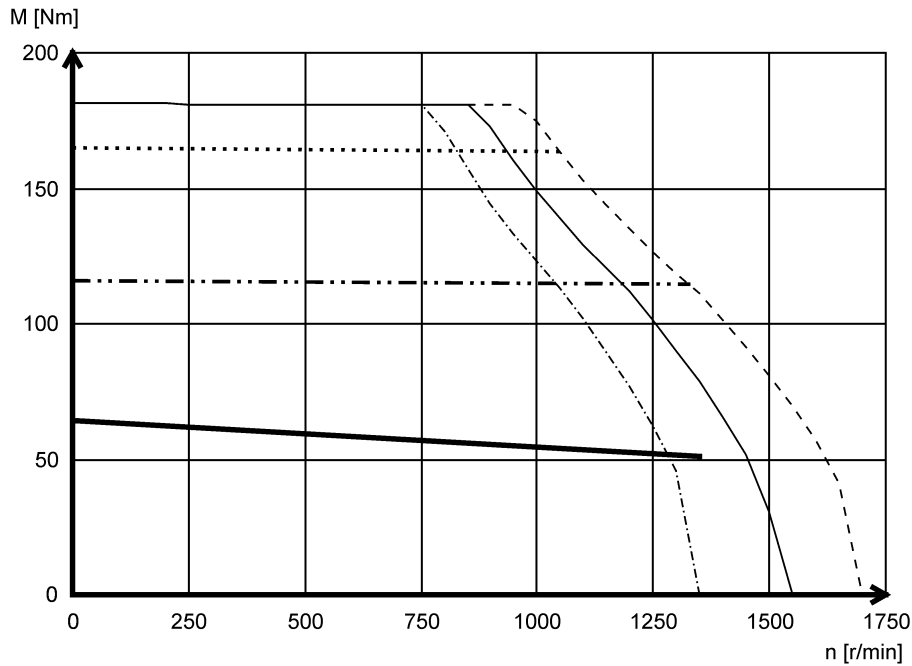

- Mmax 440 V
- Mmax 400 V
- · - · Mmax 360 V
- Mmax @ Imax= 3x I0
- · - · Mmax @ Imax= 2x I0
- S1

Technical data

Torque characteristics



MCS19P29- (forced ventilated)

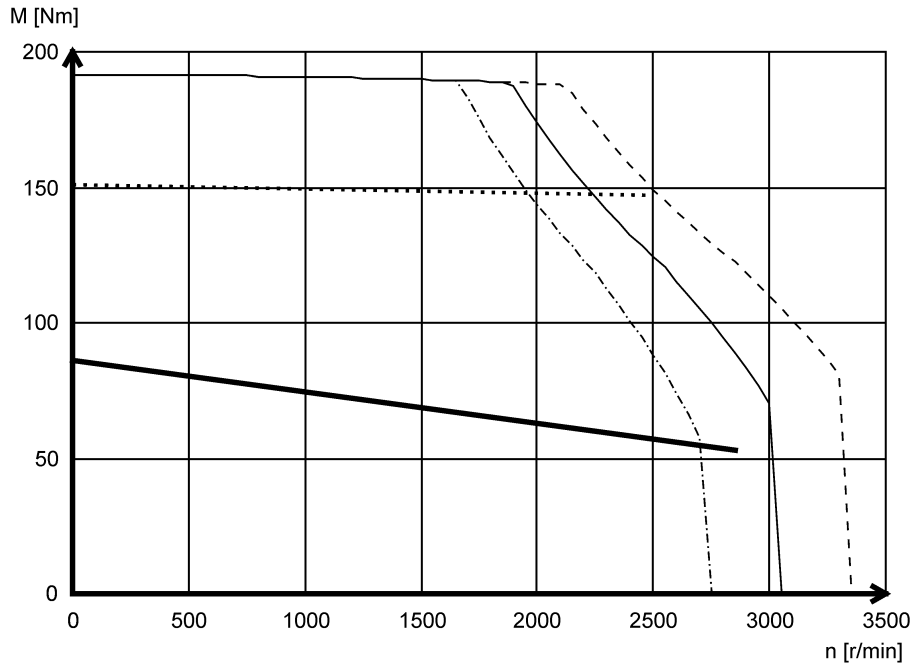

- Mmax 440 V
- Mmax 400 V
- · - · Mmax 360 V
- Mmax @ Imax= 2x I0
- S1

MCS19P30- (self-ventilated)

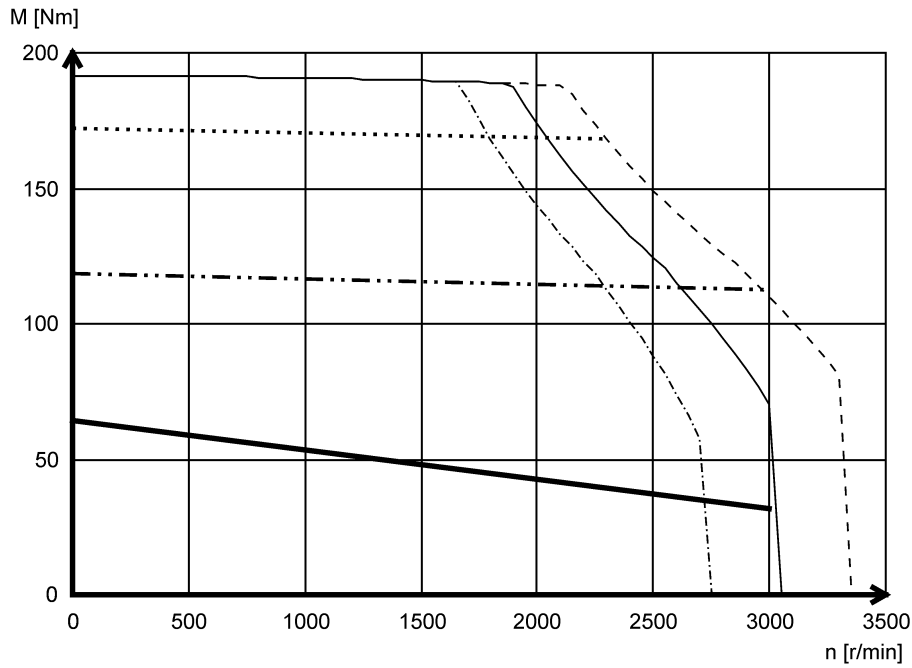

- Mmax 440 V
- Mmax 400 V
- · - · Mmax 360 V
- Mmax @ Imax= 3x I0
- · - · - Mmax @ Imax= 2x I0
- S1



The following data apply to an inverter mains voltage 3 x 230 V.

MCS06C41L (self-ventilated)

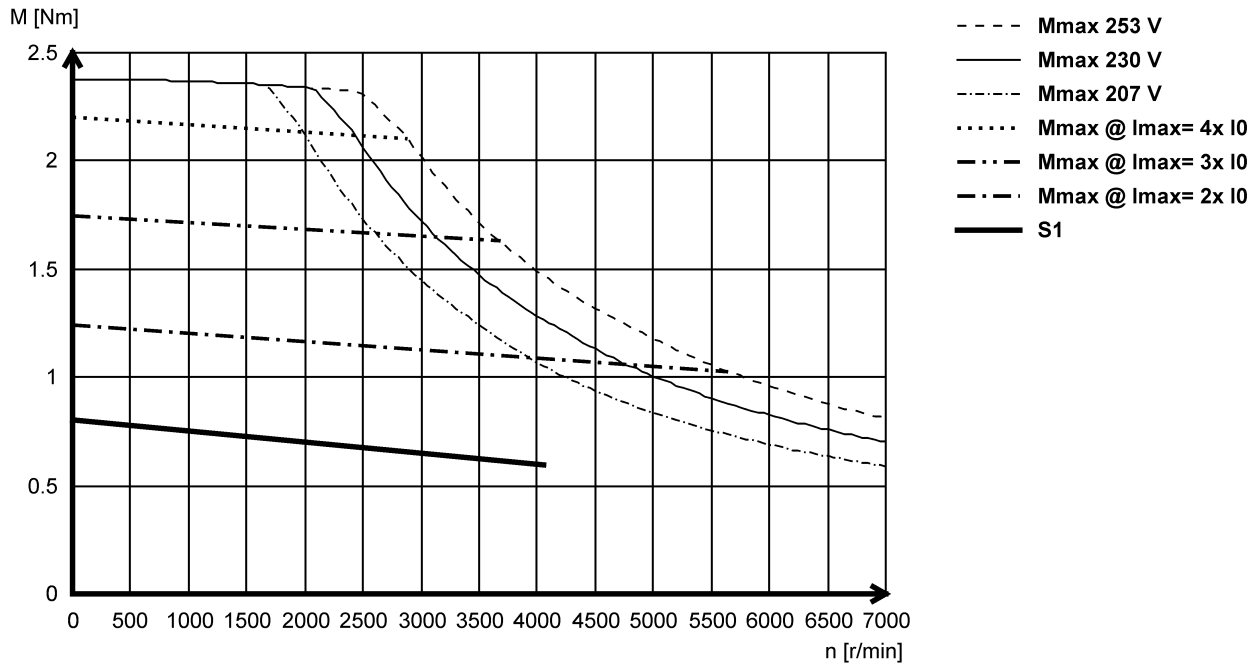

MCS06C60L- (self-ventilated)

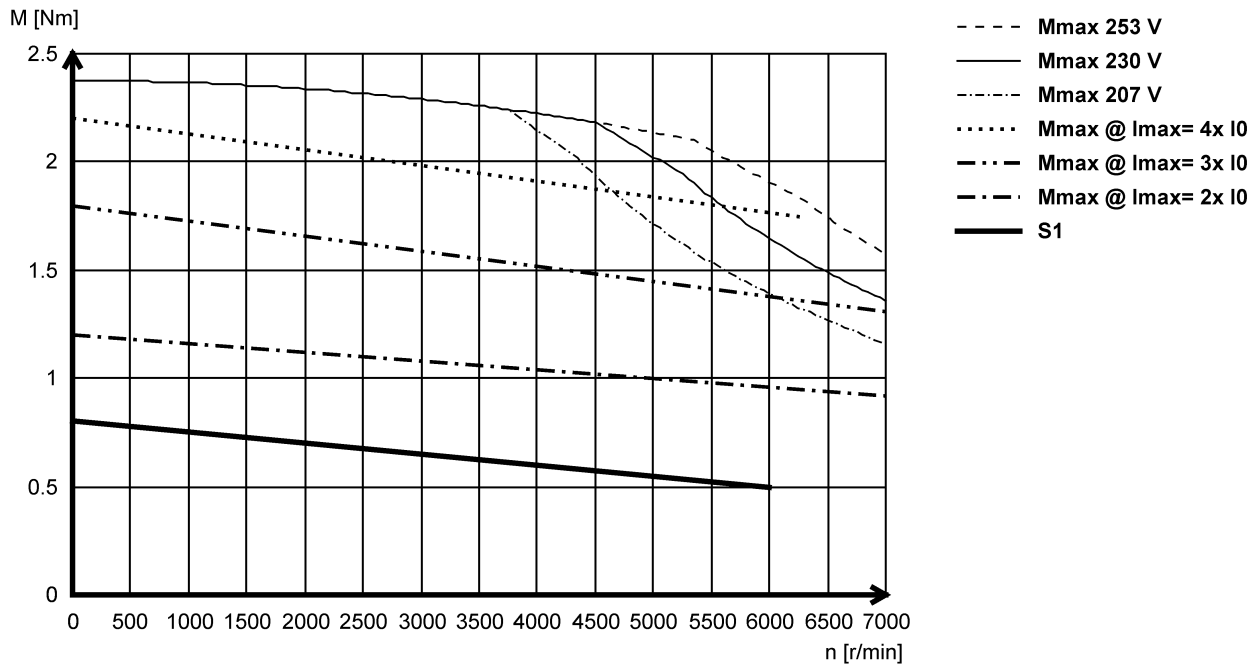

Technical data

Torque characteristics



MCS06F41L (self-ventilated)

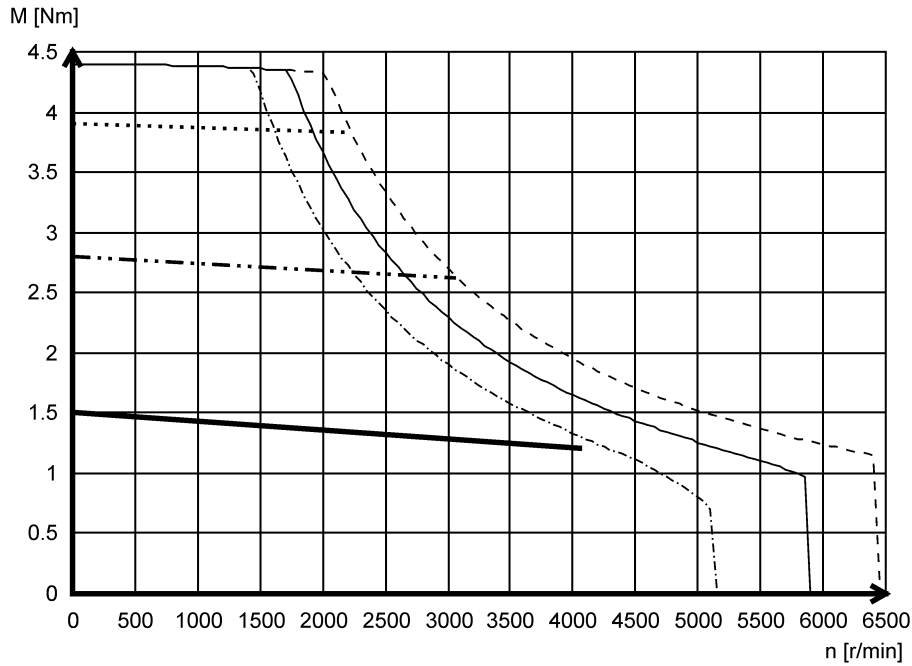

- Mmax 253 V
- Mmax 230 V
- · - · Mmax 207 V
- Mmax @ Imax= 3x I₀
- · · - Mmax @ Imax= 2x I₀
- S1

MCS06F60L- (self-ventilated)

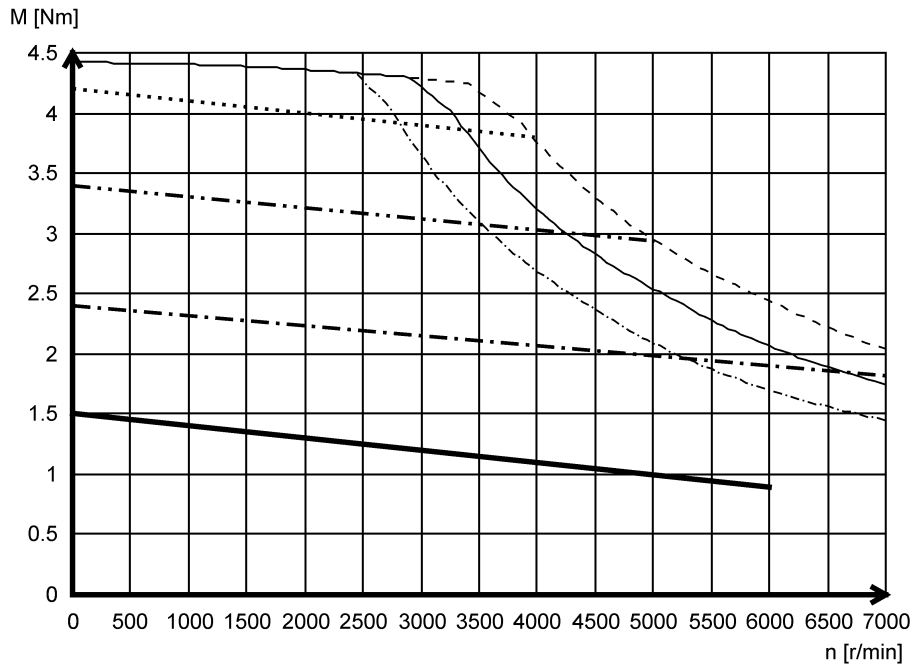

- Mmax 253 V
- Mmax 230 V
- · - · Mmax 207 V
- Mmax @ Imax= 4x I₀
- · · - Mmax @ Imax= 3x I₀
- · · · Mmax @ Imax= 2x I₀
- S1



Technical data

Torque characteristics

MCS06I41L (self-ventilated)

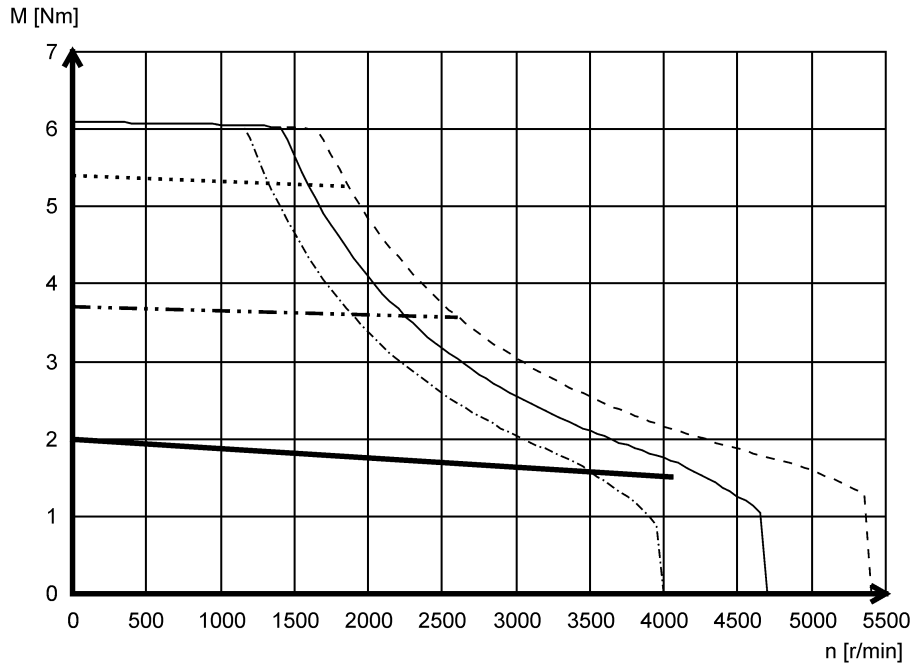

- Mmax 253 V
- Mmax 230 V
- · - · Mmax 207 V
- Mmax @ Imax= 3x I0
- · · - Mmax @ Imax= 2x I0
- S1

MCS06I60L- (self-ventilated)

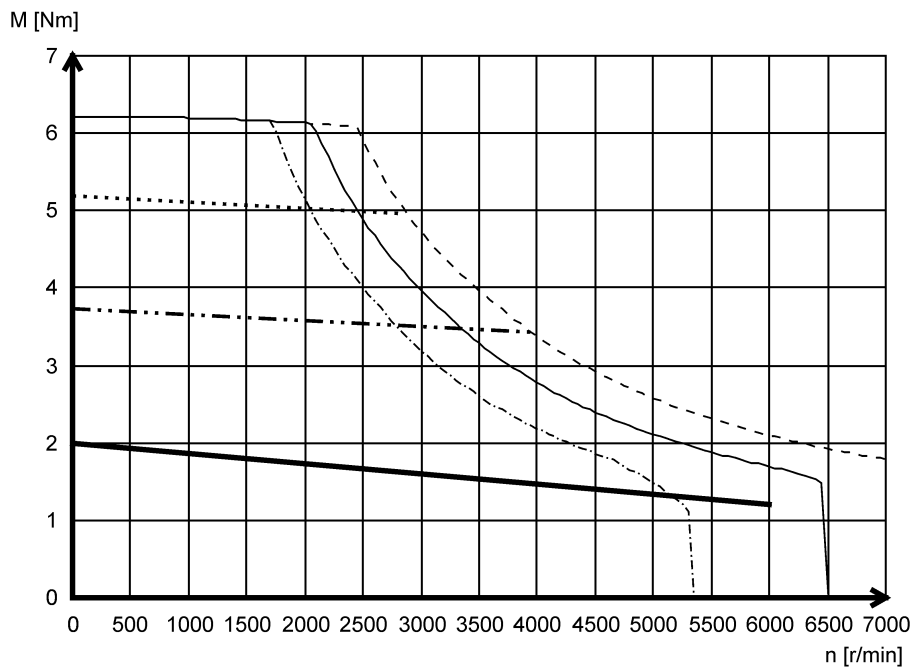

- Mmax 253 V
- Mmax 230 V
- · - · Mmax 207 V
- Mmax @ Imax= 3x I0
- · · - Mmax @ Imax= 2x I0
- S1

Technical data

Torque characteristics



MCS09D41L (self-ventilated)

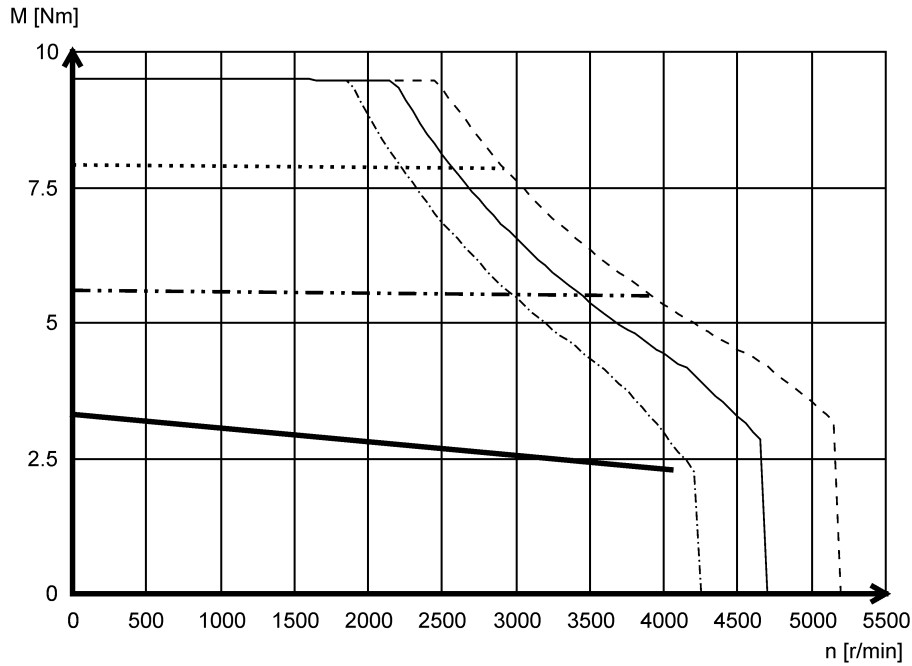

- Mmax 253 V
- Mmax 230 V
- · - · Mmax 207 V
- Mmax @ Imax= 3x I0
- · - · - Mmax @ Imax= 2x I0
- S1

MCS09D60L (self-ventilated)

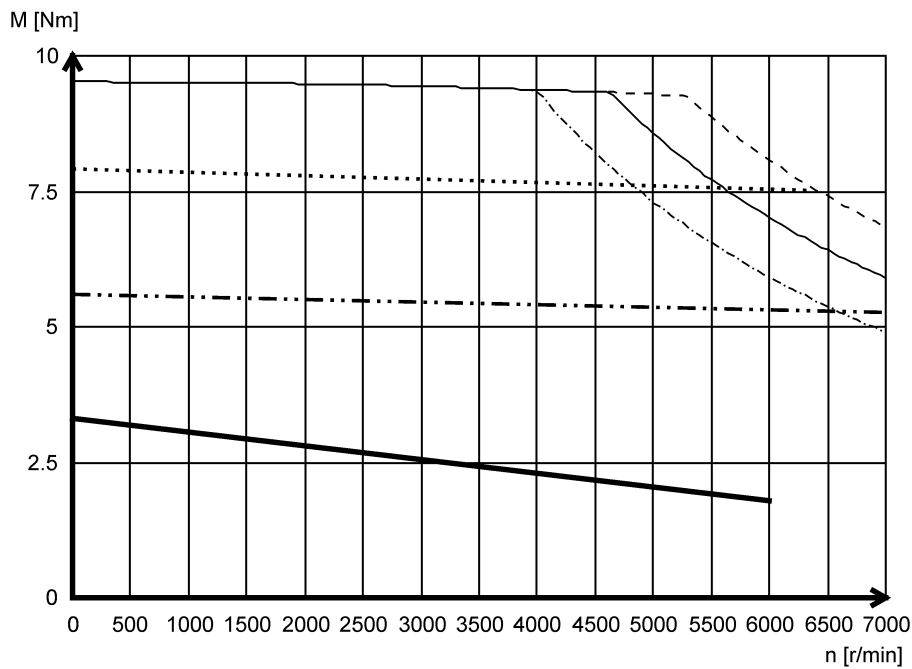

- Mmax 253 V
- Mmax 230 V
- · - · Mmax 207 V
- Mmax @ Imax= 3x I0
- · - · - Mmax @ Imax= 2x I0
- S1



Technical data

Torque characteristics

MCS09F38L (self-ventilated)

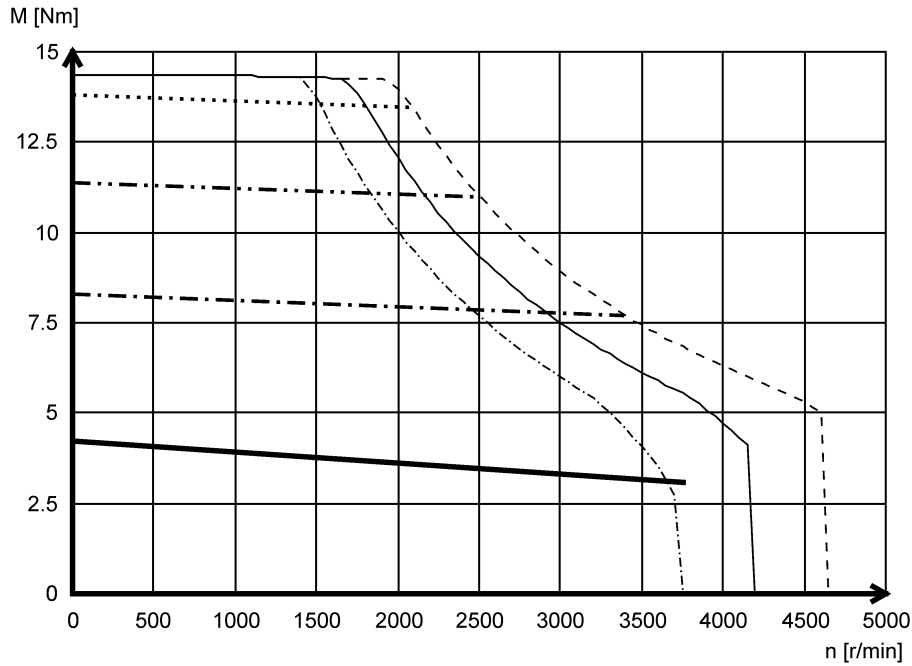

- Mmax 253 V
- Mmax 230 V
- · - · Mmax 207 V
- Mmax @ Imax= 4x I₀
- · · - Mmax @ Imax= 3x I₀
- - - Mmax @ Imax= 2x I₀
- S1

MCS09F60L (self-ventilated)

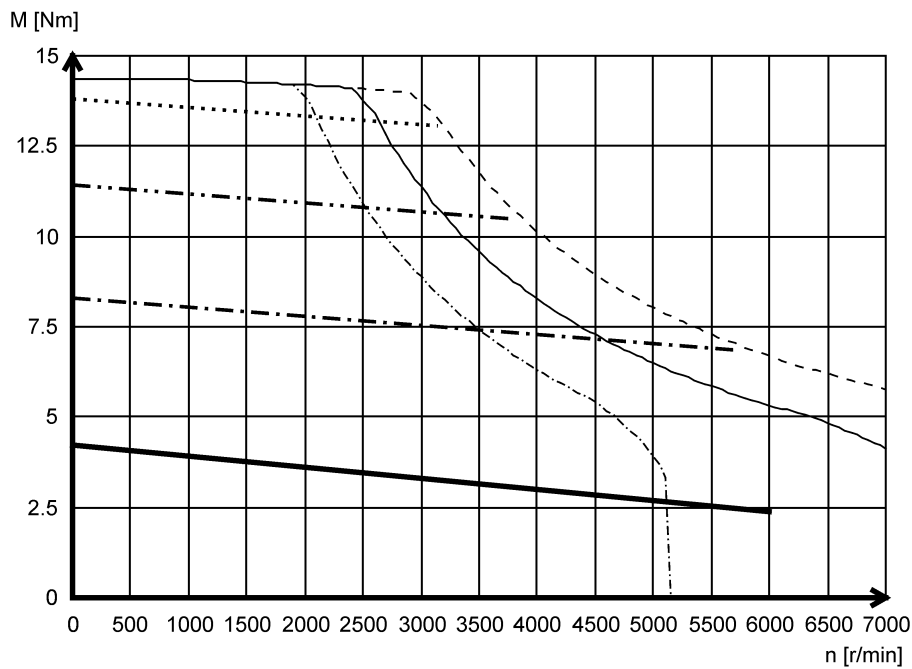

- Mmax 253 V
- Mmax 230 V
- · - · Mmax 207 V
- Mmax @ Imax= 4x I₀
- · · - Mmax @ Imax= 3x I₀
- - - Mmax @ Imax= 2x I₀
- S1

Technical data

Torque characteristics



MCS09H41L (self-ventilated)

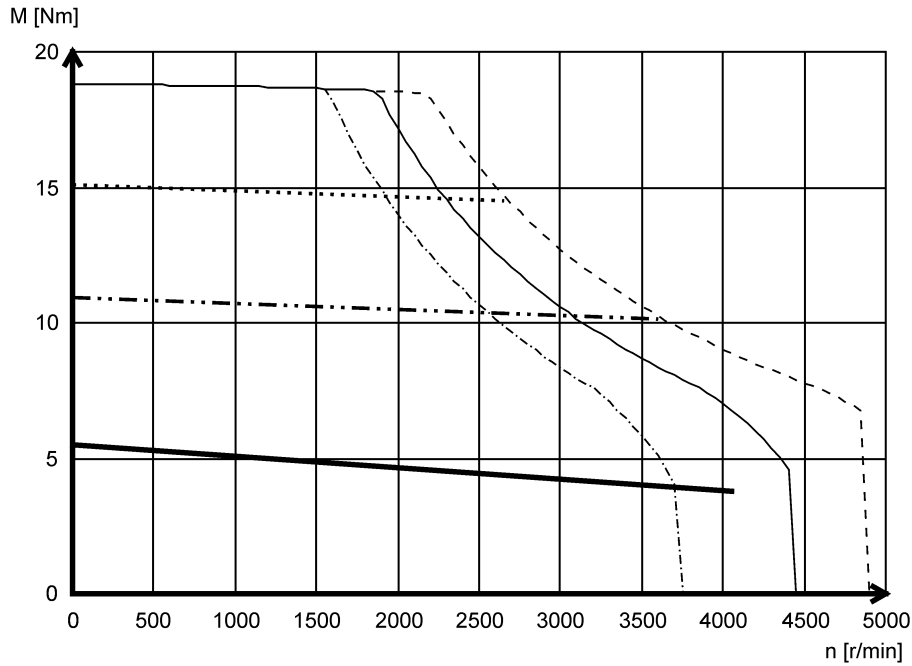

- Mmax 253 V
- Mmax 230 V
- · - · - Mmax 207 V
- · · · · Mmax @ I_{max}= 3x I₀
- · - · - Mmax @ I_{max}= 2x I₀
- S1

MCS09H60L (self-ventilated)

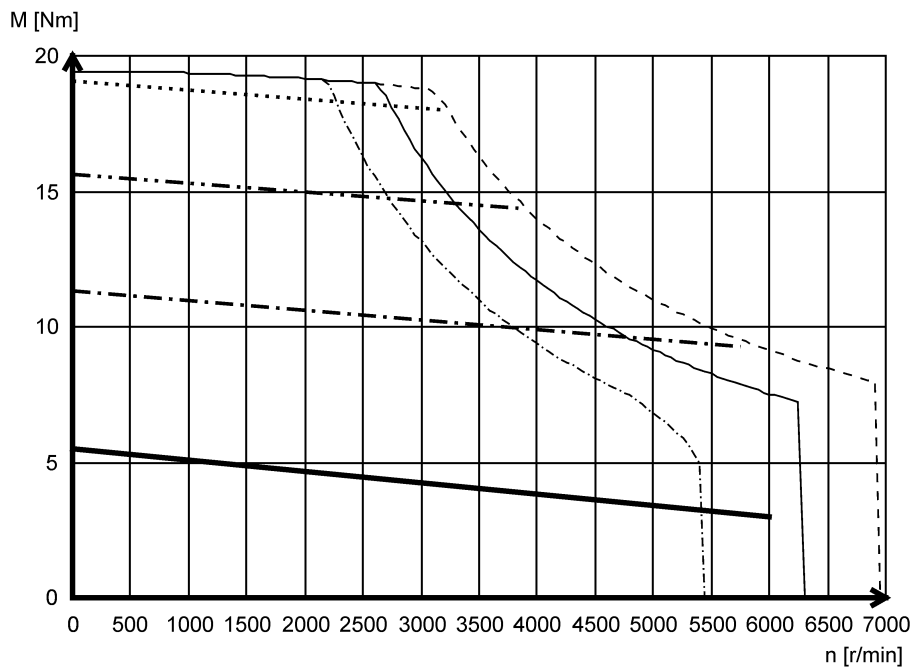

- Mmax 253 V
- Mmax 230 V
- · - · - Mmax 207 V
- · · · · Mmax @ I_{max}= 4x I₀
- · · · · Mmax @ I_{max}= 3x I₀
- · - · - Mmax @ I_{max}= 2x I₀
- S1



Technical data

Torque characteristics

MCS09L41L (self-ventilated)

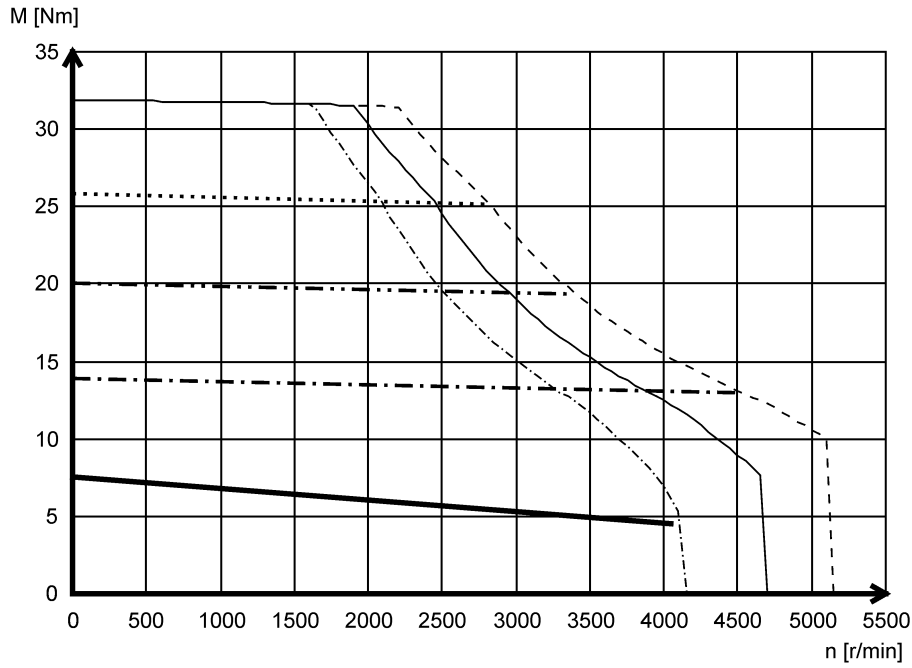

- Mmax 253 V
- Mmax 230 V
- · - · - Mmax 207 V
- Mmax @ Imax= 4x I₀
- · · - Mmax @ Imax= 3x I₀
- - - Mmax @ Imax= 2x I₀
- S1

MCS12D20L (self-ventilated)

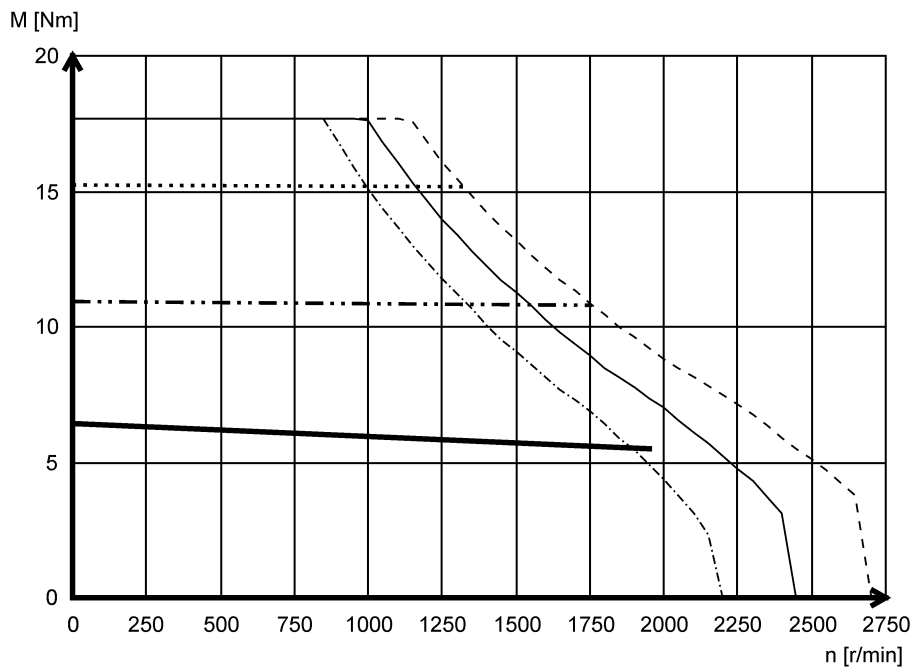

- Mmax 253 V
- Mmax 230 V
- · - · - Mmax 207 V
- Mmax @ Imax= 3x I₀
- · · - Mmax @ Imax= 2x I₀
- S1

Technical data

Torque characteristics



MCS12D41L (self-ventilated)

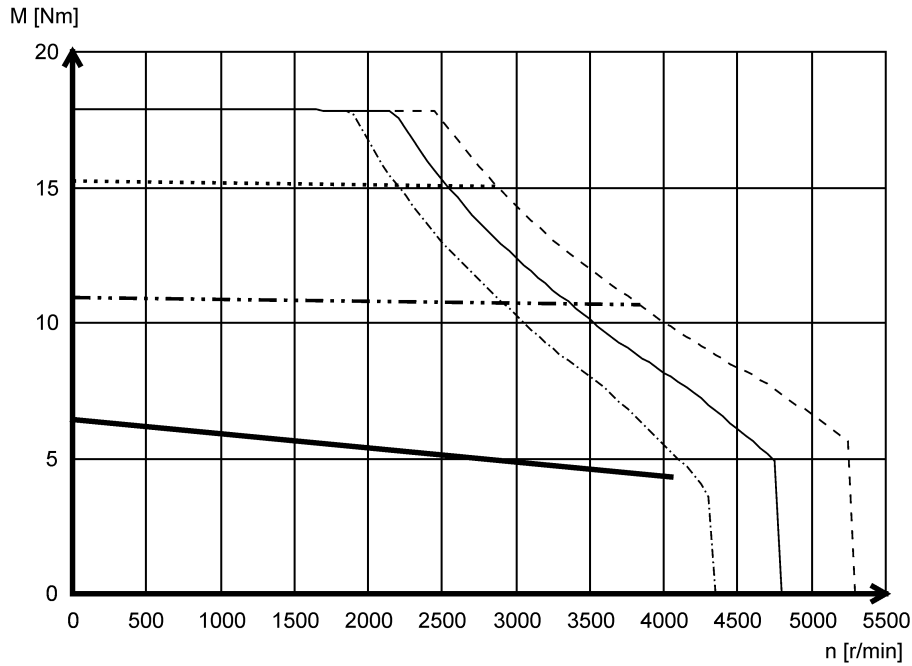

- Mmax 253 V
- Mmax 230 V
- · - · Mmax 207 V
- Mmax @ Imax= 3x I0
- · - · Mmax @ Imax= 2x I0
- S1

MCS12H15L (self-ventilated)

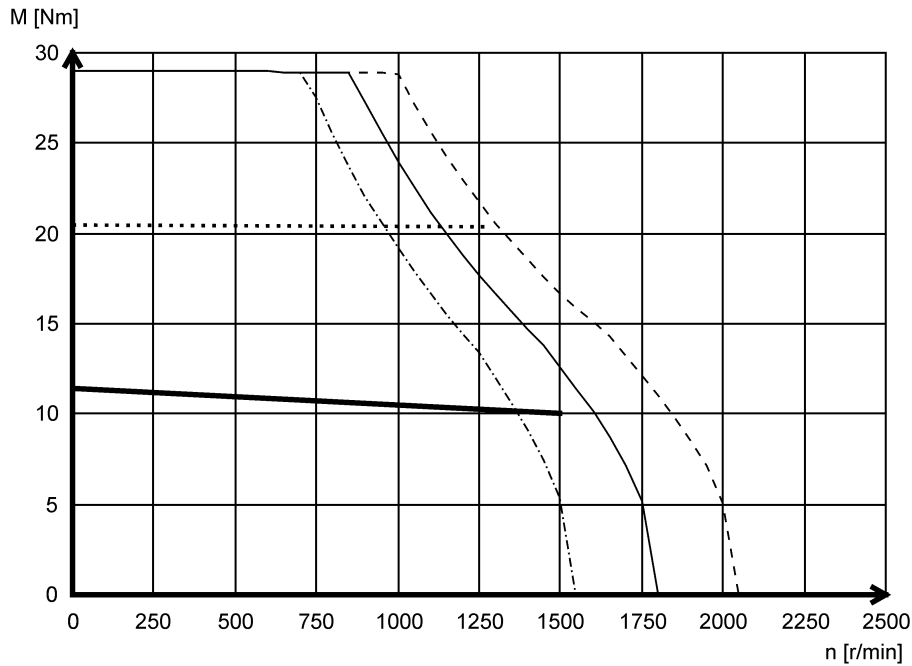

- Mmax 253 V
- Mmax 230 V
- · - · Mmax 207 V
- Mmax @ Imax= 2x I0
- S1



Technical data

Torque characteristics

MCS12H30L- (self-ventilated)

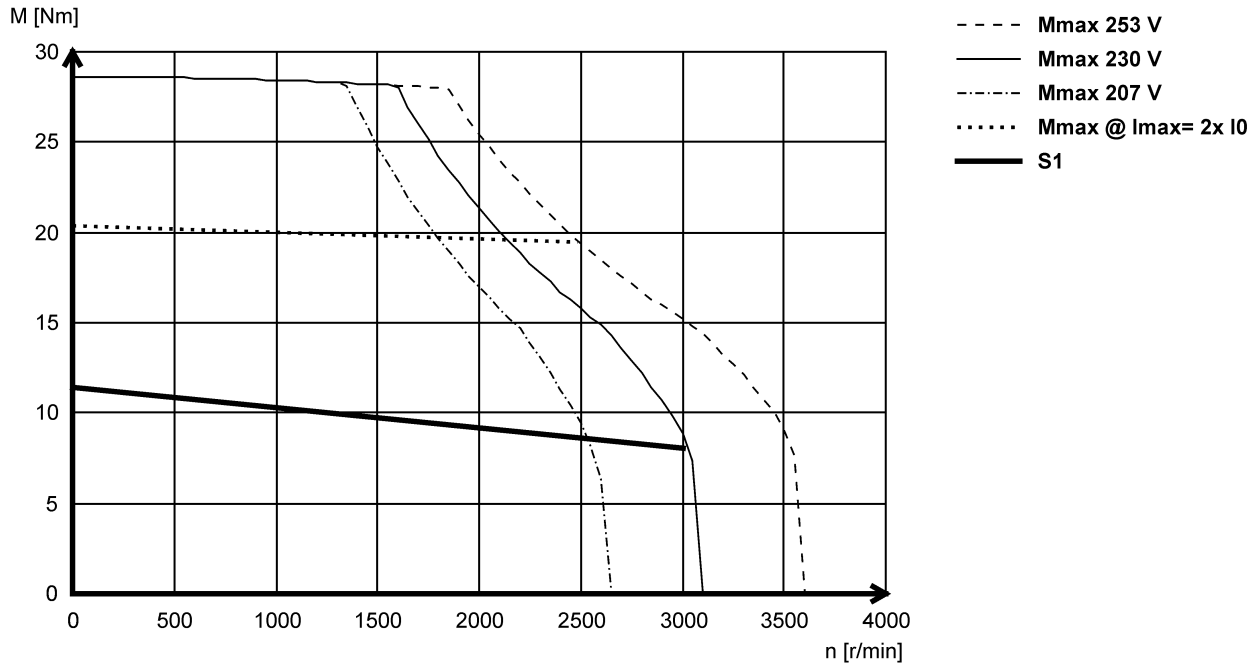

MCS12L20L (self-ventilated)

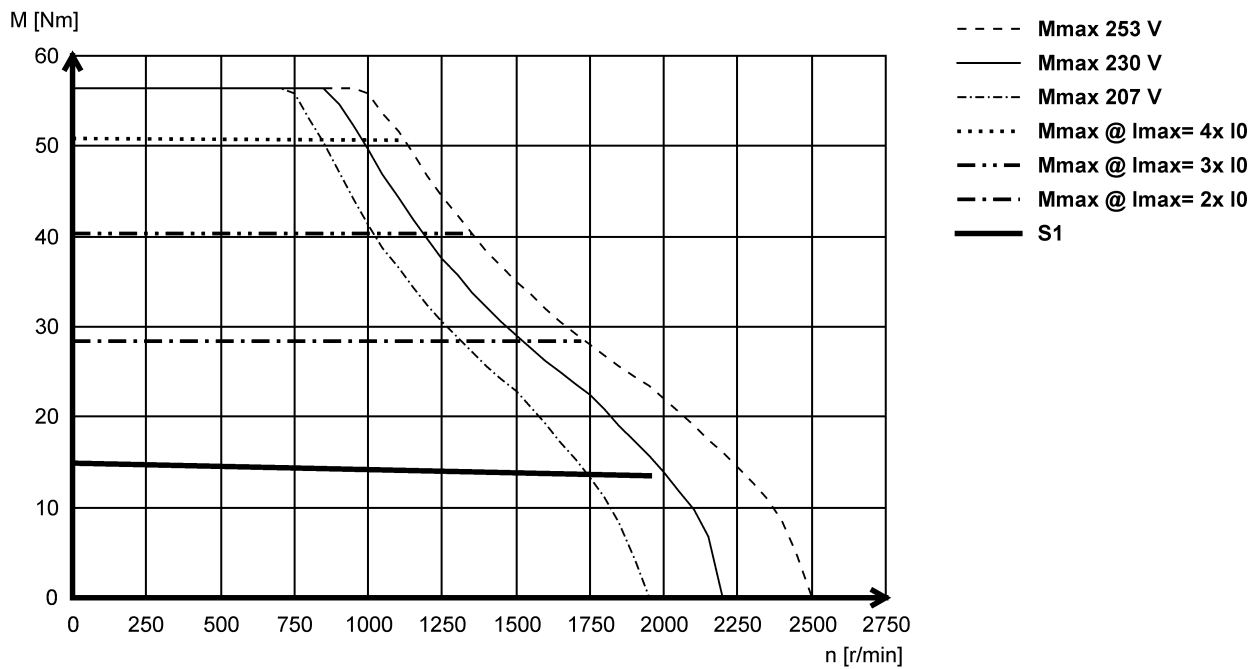

Technical data

Dimensions



Dimensions

Notes on the basic dimensions



The dimensions also apply for motors with One Cable Technology (OCT).

Table content

Explanation

Total length without brake	L	Total length of the drive with resolver
Total length with brake	L	Total length of the drive with resolver
Motor/connection distance	AD	Distance from center of motor to end of connector/terminal box



Technical data

Dimensions
Basic dimensions

Basic dimensions

MCS06, self-ventilated

Design B5-FF75

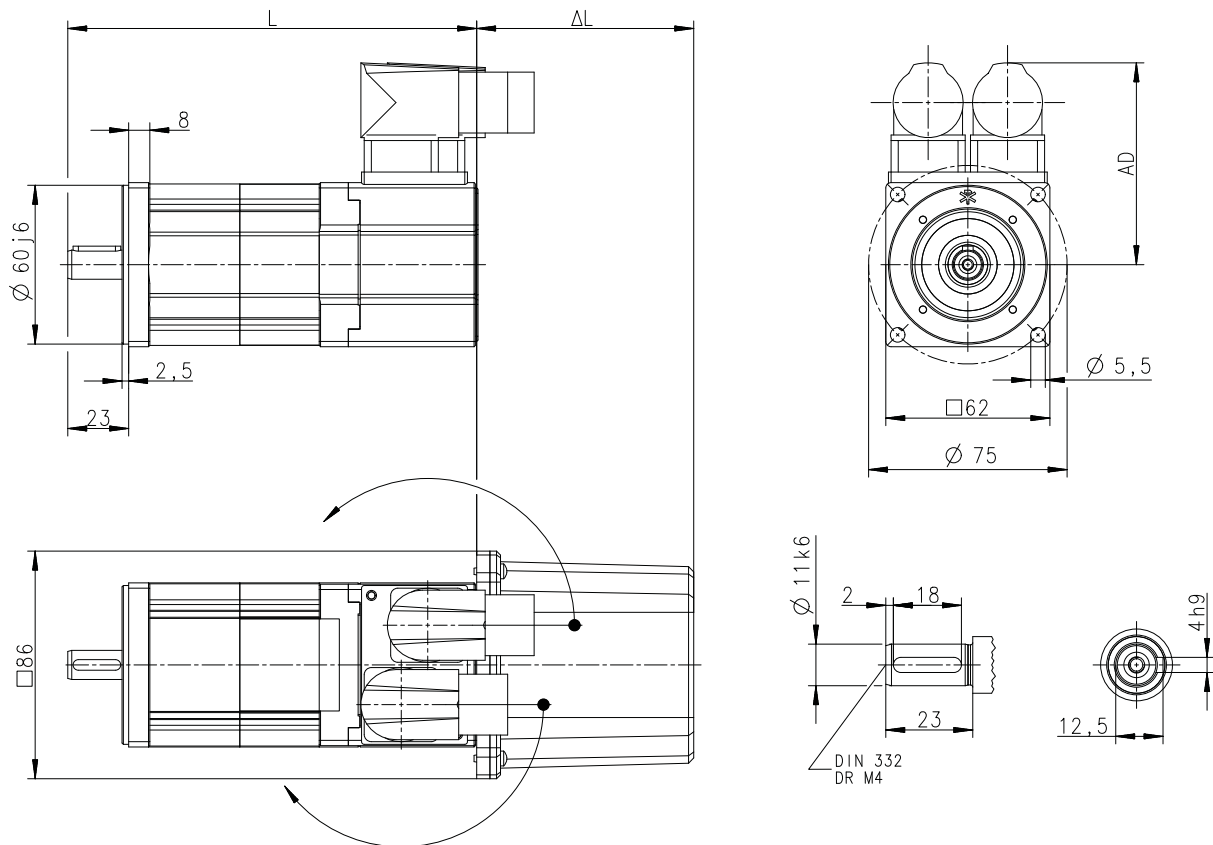

8800650-00

Motor			MCS 06C41- MCS 06C41L	MCS 06C60- MCS 06C60L	MCS 06F41- MCS 06F41L	MCS 06F60- MCS 06F60L	MCS 06I41- MCS 06I41L	MCS 06I60- MCS 06I60L
Total length without brake	L	mm	155		185		215	
Total length with brake	L	mm	174		204		234	
Motor/connection distance	AD	mm	77					

ΔL ▶ Additional lengths [109](#)

Technical data

Dimensions
Basic dimensions



MCS09, self-ventilated

Design B5-FF100

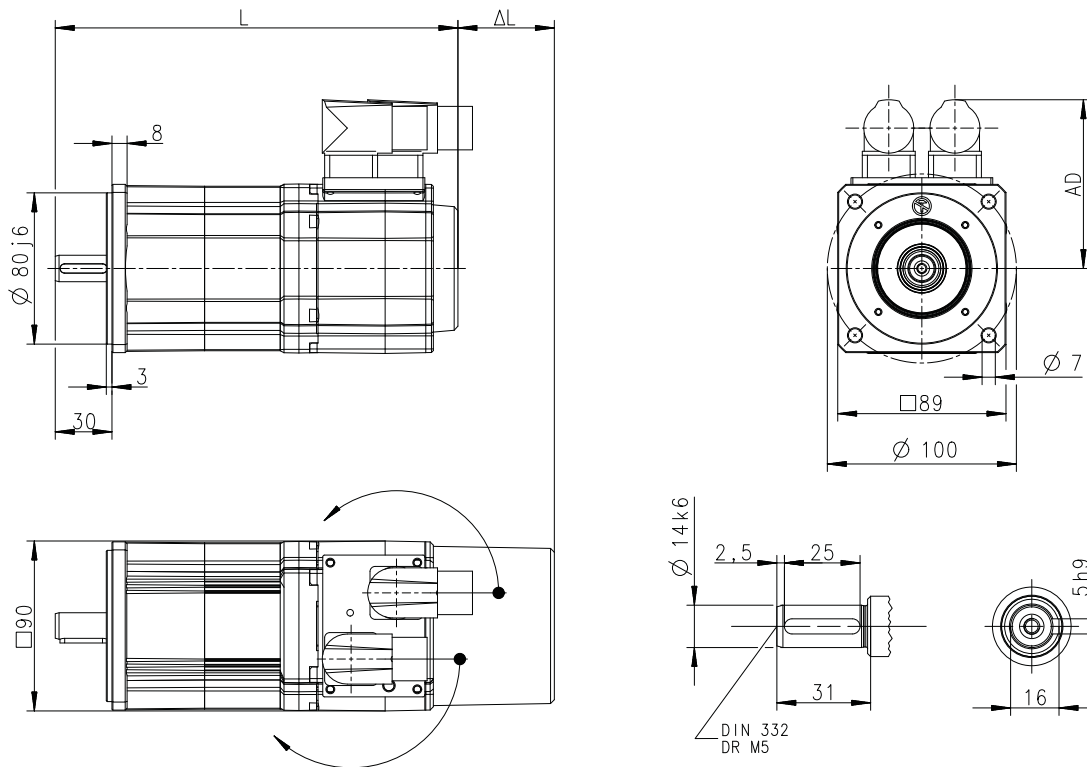

8800651-00

Motor			MCS 09D41- MCS 09D41L	MCS 09D60- MCS 09D60L	MCS 09F38- MCS 09F38L	MCS 09F60- MCS 09F60L	MCS 09H41- MCS 09H41L	MCS 09H60- MCS 09H60L
Total length without brake	L	mm	213		233		253	
Total length with brake	L	mm	233		253		273	
Motor/connection distance	AD	mm	90					

Motor			MCS 09L41- MCS 09L41L	MCS 09L51-
Total length without brake	L	mm	293	
Total length with brake	L	mm	313	
Motor/connection distance	AD	mm	90	

Δ L ▶ [Additional lengths](#) 109



Technical data

Dimensions
Basic dimensions

MCS12, self-ventilated

Design B5-FF130

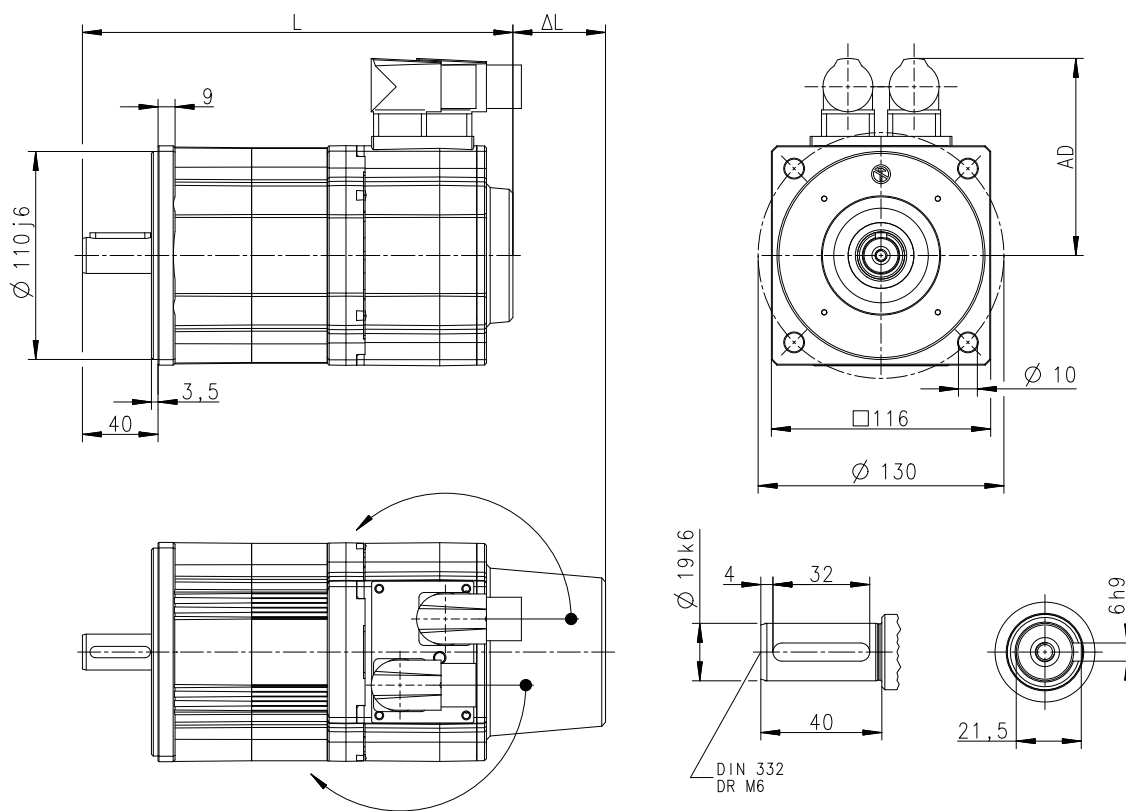

8800652-00

Motor			MCS 12D20- MCS 12D20L	MCS 12D41- MCS 12D41L	MCS 12H15- MCS 12H15L	MCS 12H30L	MCS 12H35-	MCS 12L20- MCS 12L20L
Total length without brake	L	mm	228		268			308
Total length with brake	L	mm	248		288			328
Motor/connection distance	AD	mm	105					

Motor			MCS 12L41-					
Total length without brake	L	mm	308					
Total length with brake	L	mm	328					
Motor/connection distance	AD	mm	105					

ΔL ▶ Additional lengths [109](#)

Technical data

Dimensions
Basic dimensions



MCS12, forced ventilated

Design B5-FF130

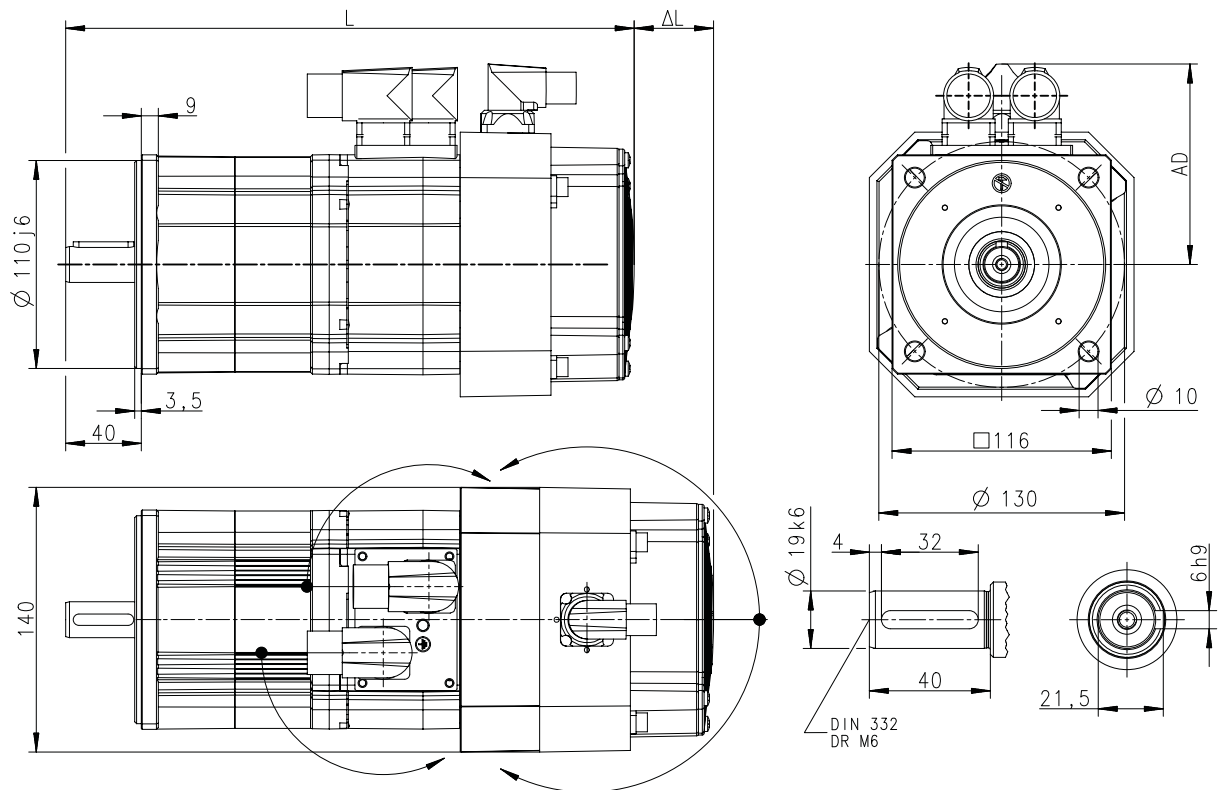

8800655-00

Motor			MCS 12D17-	MCS 12D35-	MCS 12H14-	MCS 12H34-	MCS 12L17-	MCS 12L39-
Total length without brake	L	mm	301		341		381	
Total length with brake	L	mm	321		361		401	
Motor/connection distance	AD	mm			105			

ΔL ▶ [Additional lengths](#) □ 109



Technical data

Dimensions
Basic dimensions

MCS14, self-ventilated Design B5-FF165

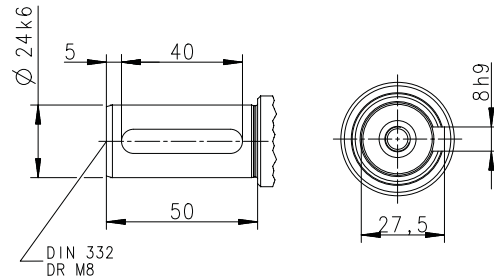
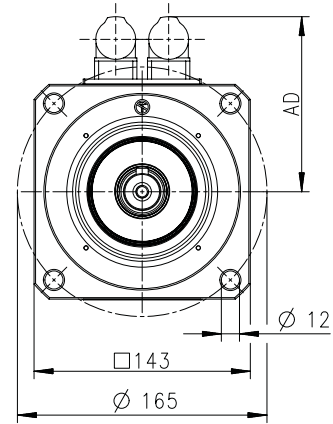
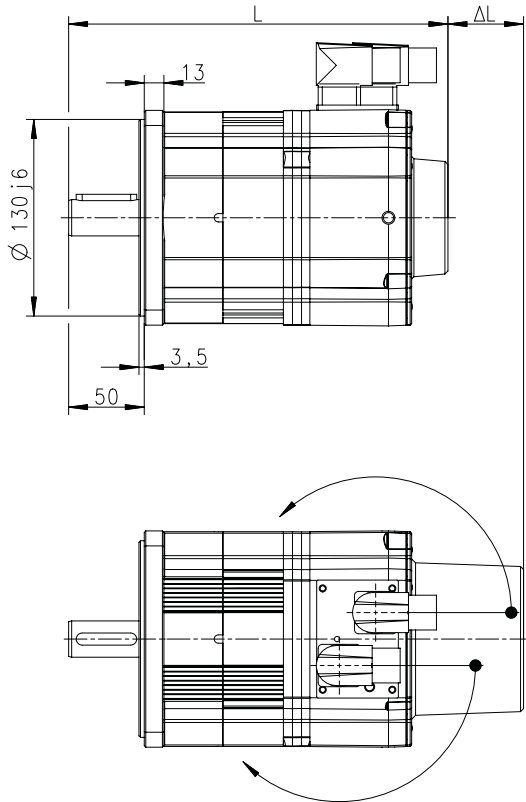

8800653-00

Motor			MCS 14D15-	MCS 14D36-	MCS 14H15-	MCS 14H32-	MCS 14L15-	MCS 14L32-	
Total length without brake	L	mm	251		291		331		
Total length with brake	L	mm	279		319		359		
Motor/connection distance	AD	mm	117					146	
Motor			MCS 14P14-			MCS 14P32-			
Total length without brake	L	mm				371			
Total length with brake	L	mm				399			
Motor/connection distance	AD	mm	117			146			

Δ L ▶ Additional lengths [109](#)

Technical data

Dimensions
Basic dimensions



MCS14, forced ventilated

Design B5-FF165

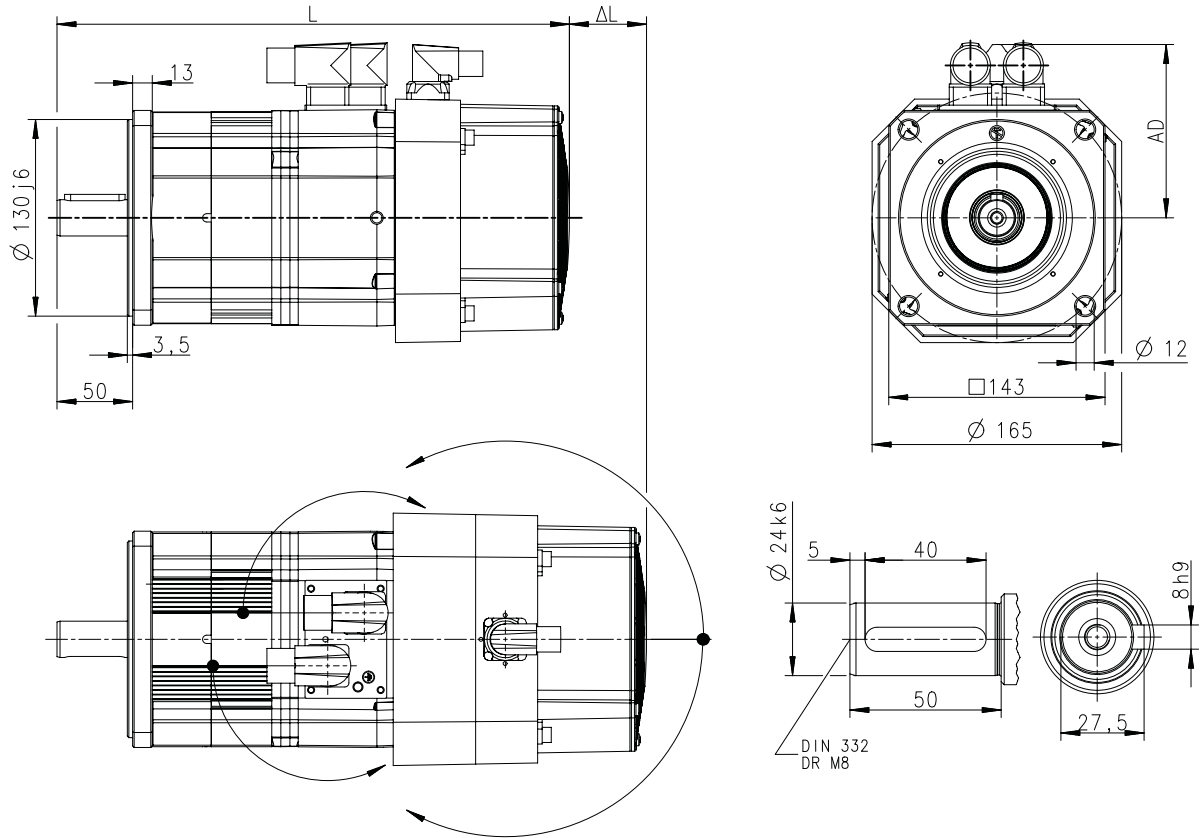

8800656-00

Motor			MCS 14D14-	MCS 14D30-	MCS 14H12-	MCS 14H28-	MCS 14L14-	MCS 14L30-
Total length without brake	L	mm	339		379		419	
Total length with brake	L	mm	367		407		447	
Motor/connection distance	AD	mm	117			146	117	146
Motor			MCS 14P11-			MCS 14P26-		
Total length without brake	L	mm				459		
Total length with brake	L	mm				487		
Motor/connection distance	AD	mm	117			146		

ΔL ▶ [Additional lengths](#) 109



Technical data

Dimensions
Basic dimensions

MCS19, self-ventilated Design B5-FF215

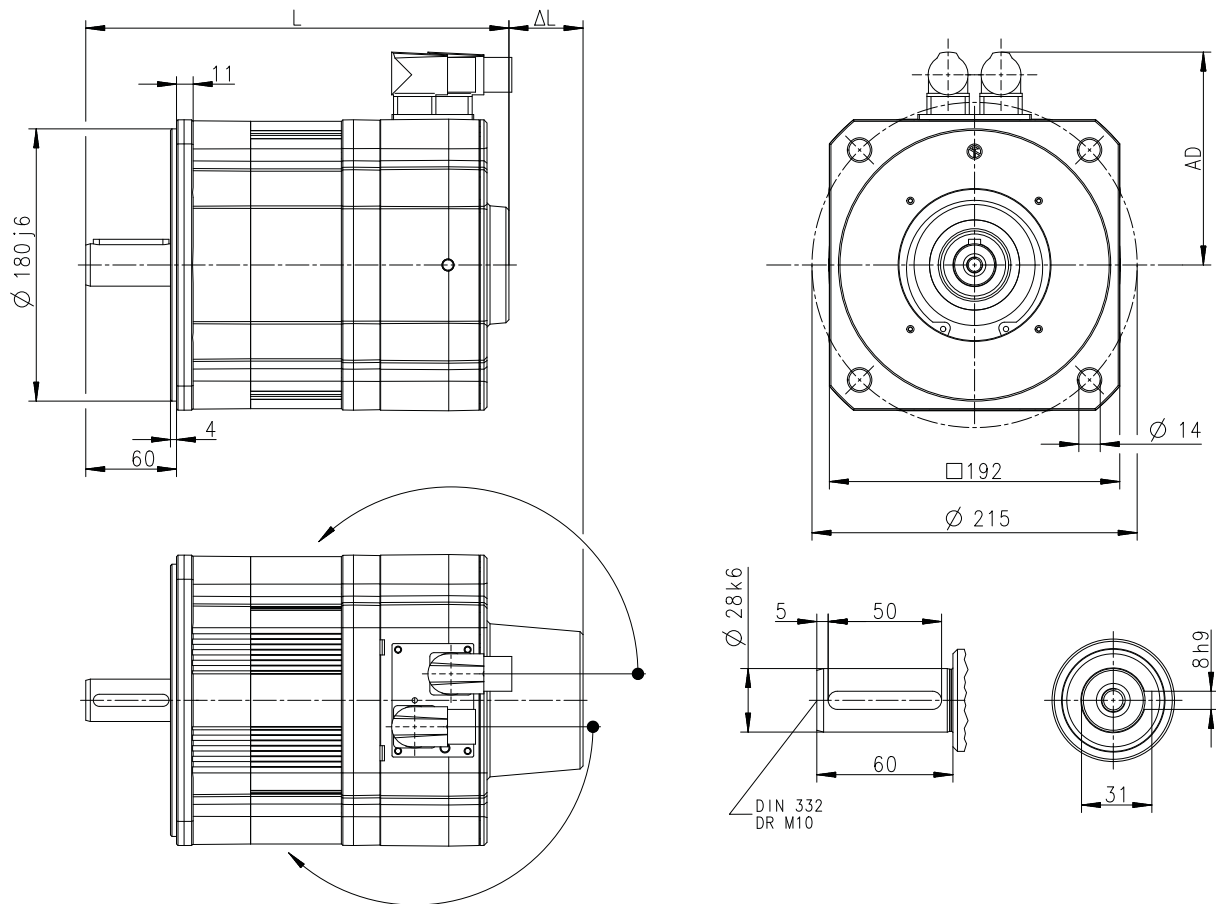

8800654-00

Motor			MCS 19F14-	MCS 19F30-	MCS 19J14-	MCS 19J30-	MCS 19P14-	MCS 19P30-
Total length without brake	L	mm	280		320		380	
Total length with brake	L	mm	324		364		424	
Motor/connection distance	AD	mm	142	171	142	171		

ΔL ▶ [Additional lengths](#) 109

Technical data

Dimensions
Basic dimensions



MCS19, forced ventilated

Design B5-FF215

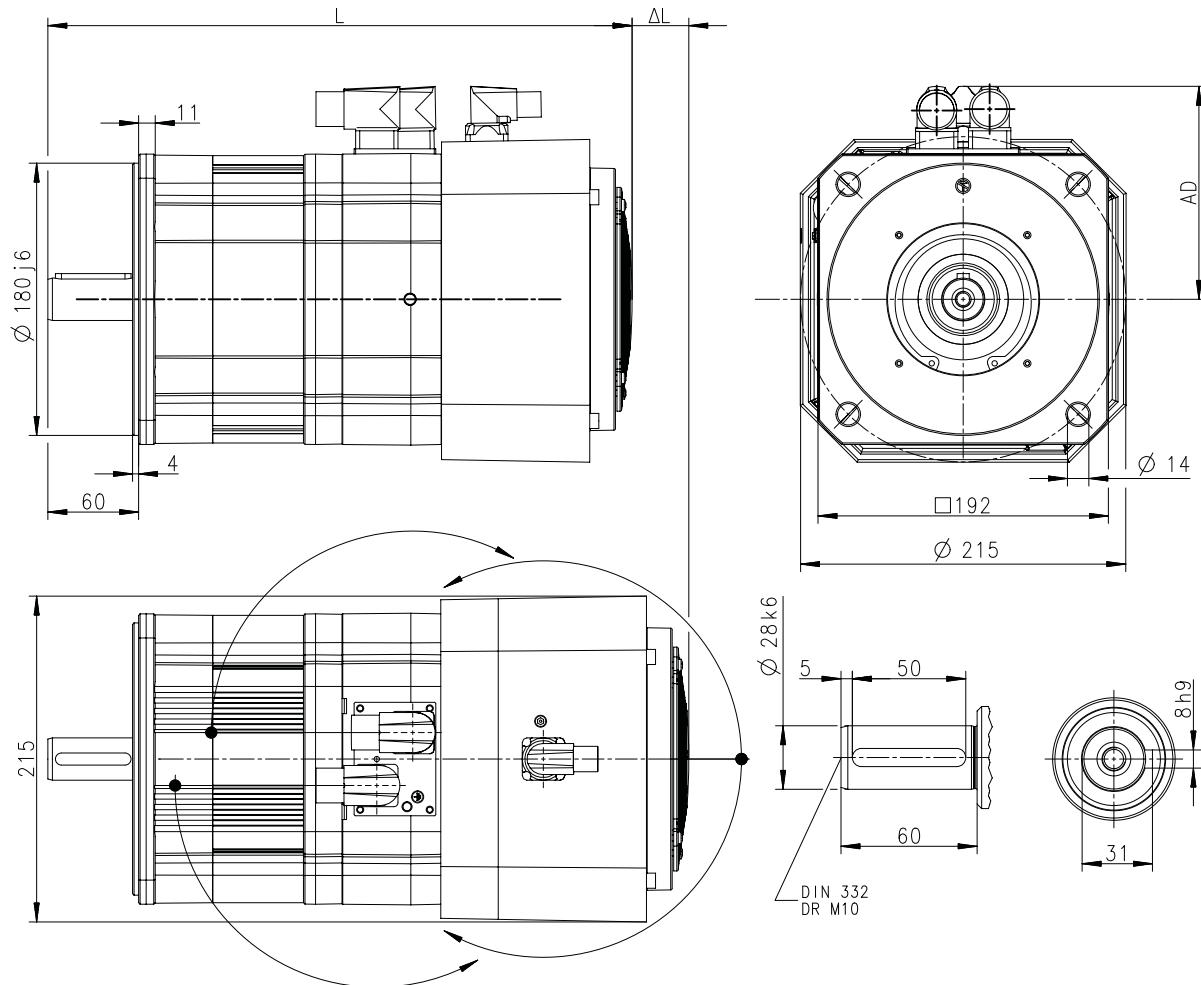

8800657-00

Motor			MCS 19F12-	MCS 19F29-	MCS 19J12-	MCS 19J29-	MCS 19P12-	MCS 19P29-
Total length without brake	L	mm	387		427		487	
Total length with brake	L	mm	431		471		531	
Motor/connection distance	AD	mm	142	171				

ΔL ▶ Additional lengths [□ 109](#)



Technical data

Dimensions
Additional lengths

Additional lengths



The motor code indicates the short designation of the brake and feedback. Detailed information can be found for

- ▶ [Product codes](#) 136
- ▶ [Brakes](#) 124
- ▶ [Feedback](#) 129

MCS06

Motor			MCS06C41- MCS06C41L MCS06C60- MCS06C60L	MCS06F41- MCS06F41L MCS06F60- MCS06F60L	MCS06I41- MCS06I41L MCS06I60- MCS06I60L
Cooling type			natural	natural	natural
R□0	Δ L	mm	0		
S□M (AM1024...)/ SRS / SVS / ECN / EQI / EQN	Δ L	mm	82		
S□M (AM128...)/ EKM / EVM	Δ L	mm	35		

MCS09

Motor			MCS09D41- MCS09D41L MCS09D60- MCS09D60L	MCS09F38- MCS09F38L MCS09F60- MCS09F60L	MCS09H41- MCS09H41L MCS09H60- MCS09H60L	MCS09L41- MCS09L41L MCS09L60-
Cooling type			natural	natural	natural	natural
R□0	Δ L	mm	0			
S□M (AM1024...)/ SRS / SVS / ECN / EQI / EQN	Δ L	mm	51			
S□M (AM128...)/ EKM / EVM	Δ L	mm	20			

MCS12

Motor			MCS12D17-	MCS12D20- MCS12D20L	MCS12D35-	MCS12D41- MCS12D41L	MCS12H14-	MCS12H15- MCS12H15L	MCS12H30L
Cooling type			Forced	Natural	Forced	Natural	Forced	Natural	Natural
R□0	Δ L	mm	0	0	0	0	0	0	0
S□M (AM1024...)/ SRS / SVS / ECN / EQI / EQN	Δ L	mm	43	49	43	49	43	49	49
S□M (AM128...)/ EKM / EVM	Δ L	mm	43	20	43	20	43	20	20

Motor			MCS12H34-	MCS12H35-	MCS12L17-	MCS12L20- MCS12L20L	MCS12L39-	MCS12L41- MCS12L41L
Cooling type			Forced	Natural	Forced	Natural	Forced	Natural
R□0	Δ L	mm	0	0	0	0	0	0
S□M (AM1024...)/ SRS / SVS / ECN / EQI / EQN	Δ L	mm	43	49	43	49	43	49
S□M (AM128...)/ EKM / EVM	Δ L	mm	43	20	43	20	43	20

Technical data

Weights
Basic weights



MCS14

Motor			MCS14D14-	MCS14D15-	MCS14D30-	MCS14D36-	MCS14H12-	MCS14H15-	MCS14H28-	MCS14H32-
Cooling type			Blower	natural	Blower	natural	Blower	natural	Blower	natural
R□0	Δ L	mm	0	0	0	0	0	0	0	0
S□M (AM1024...)/ SRS / SVS / ECN / EQI / EQN	Δ L	mm	53	50	53	50	53	50	53	50
S□M (AM128...)/ EKM / EVM	Δ L	mm	53	18	53	18	53	18	53	18

Motor			MCS14L14-	MCS14L15-	MCS14L30-	MCS14L32-	MCS14P11-	MCS14P14-	MCS14P26-	MCS14P32-
Cooling type			Blower	natural	Blower	natural	Blower	natural	Blower	natural
R□0	Δ L	mm	0	0	0	0	0	0	0	0
S□M (AM1024...)/ SRS / SVS / ECN / EQI / EQN	Δ L	mm	53	50	53	50	53	50	53	50
S□M (AM128...)/ EKM / EVM	Δ L	mm	53	18	53	18	53	18	53	18

MCS19

Motor			MCS19F12-	MCS19F14-	MCS19F29-	MCS19F30-	MCS19J12-	MCS19J14-
Cooling type			Blower	natural	Blower	natural	Blower	natural
R□0	Δ L	mm	0	0	0	0	0	0
S□M (AM1024...)/ SRS / SVS / ECN / EQI / EQN	Δ L	mm	72	49	72	49	72	49
S□M (AM128...)/ EKM / EVM	Δ L	mm	72	19	72	19	72	19

Motor			MCS19J29-	MCS19J30-	MCS19P12-	MCS19P14-	MCS19P29-	MCS19P30-
Cooling type			Blower	natural	Blower	natural	Blower	natural
R□0	Δ L	mm	0	0	0	0	0	0
S□M (AM1024...)/ SRS / SVS / ECN / EQI / EQN	Δ L	mm	72	49	72	49	72	49
S□M (AM128...)/ EKM / EVM	Δ L	mm	72	19	72	19	72	19

Weights

Basic weights



The basic weights are listed in the rated data.

▶ [Rated data](#) 25

Observe ▶ [Additional weights](#) 110!

Additional weights

Motors

Motor			MCS06C MCS06F MCS06I	MCS09D MCS09F MCS09H MCS09L	MCS12D MCS12H MCS12L	MCS14D MCS14H MCS14L MCS14P	MCS19F	MCS19J MCS19P
Permanent magnet holding brake								
Standard braking torque	m	kg	0.3	0.8	0.9	1.9	3.1	
Increased braking torque	m	kg		0.8	1.2	3.1		4.3



Product extensions

Motor connection
Connection via terminal box

Product extensions

Motor connection

Connection via terminal box

If a motor is to be connected to an existing cable or plug connectors are not to be used for other reasons, the connection can also be made via a terminal box.

The terminals are designed as tension spring terminals to ensure here the long-term vibration resistance of the cable contacts with adequate contact pressure required.

The terminal boxes have generously dimensioned space for the customer's own wiring and large surface shield connection areas to ensure a secure EMC-compliant connection. The cable outlet may be to the left or to the right, depending on requirements.



It is not possible to attach a terminal box to the MCS06 or to models with the blower.

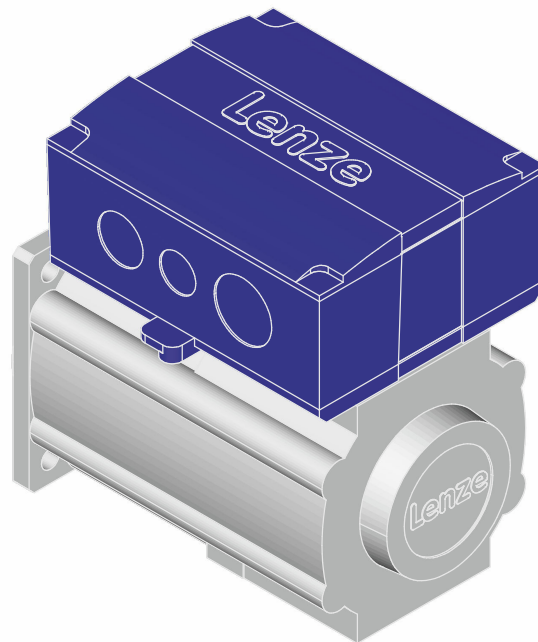

Product extensions

Motor connection
Connection via terminal box



Cable glands



The bore holes for the cable glands M25, M20 and M32 are located on both sides and closed. They can be opened according to need.

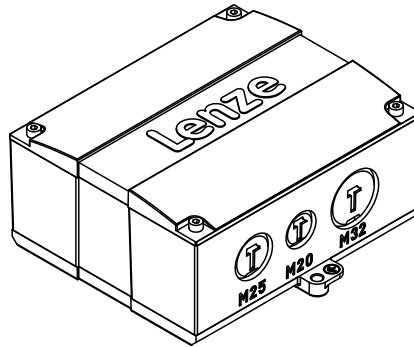

Motor	MCS09 MCS12 MCS14H	MCS14L15 MCS14P14 MCS19F15 MCS19J15	MCS14L32 MCS14P32 MCS19F13 MCS19J30 MCS19P
Screwed connections		2x M20 2x M25 2x M32	
cable cross-section	mm ²	0.08 ... 2.5 4 (without wire end ferrule)	0.2 ... 10
Stripping length	mm	10 ... 11	
Terminal design		Spring-loaded terminal	

Position of the connections

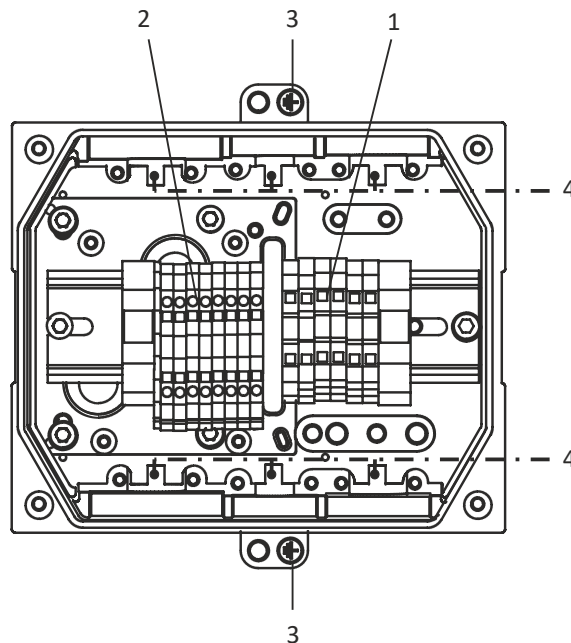

Position	Meaning
1	Power connection Brake connection
2	Feedback connection Connection of temperature monitoring
3	PE connection
4	Large area shield contact.



Product extensions

Motor connection
Connection via terminal box

Terminal box, power		
Contact	Name	Meaning
U1	L1	Motor winding phase
V1	L2	
W1	L3	
PE	PE	PE conductor

Terminal box, DC brake		
Contact	Name	Meaning
BD1	+	Brake +
BD2	-	Brake -

Terminal box, resolver		
Contact	Name	Meaning
B1	+Ref	Transformer windings (reference windings)
B2	-Ref	
B3	+VCC ETS	Supply: Electronic nameplate (only for variant with electronic nameplate ETS)
B4	+COS	Cosine stator windings
B5	-COS	
B6	+SIN	Sine stator windings
B7	-SIN	
B8		Not assigned

Terminal box, SinCos absolute value encoder with Hiperface		
Contact	Name	Meaning
B1	+ UB	Supply +
B2	GND	Mass
B3	A	Track A / + COS
B4	A ⁻	Track A inverse /-COS
B5	B	Track B / +SIN
B6	B ⁻	Track B inverse/-SIN
B7	Z	Zero track / + RS485
B8	Z ⁻	Zero track inverse /-RS485
B10		Incremental encoder shield

Terminal box, SinCos absolute value encoder with EnDat		
Contact	Name	Meaning
B1	+ UB	Supply +
B2	GND	Mass
B3	A	Track A / + COS
B4	A-	Track A inverse /-COS
B5	B	Track B / +SIN
B6	B-	Track B inverse/-SIN
B7	Daten	EnDat interface data
B8	Daten-	Data inverse EnDat interface
B20	Takt	EnDat interface cycle
B21	Takt-	Inverse EnDat interface cycle
B22	Up Sensor	Up Sensor
B23	0 V Sensor	0 V sensor
B24	Schirm	Encoder housing shield
B25		Not assigned

Terminal box with temperature monitoring R		
Contact	Name	Meaning
R1	+	Temperature sensor +
R2	-	Temperature sensor -

Product extensions

Motor connection
Connection via terminal box



Terminal box dimensions

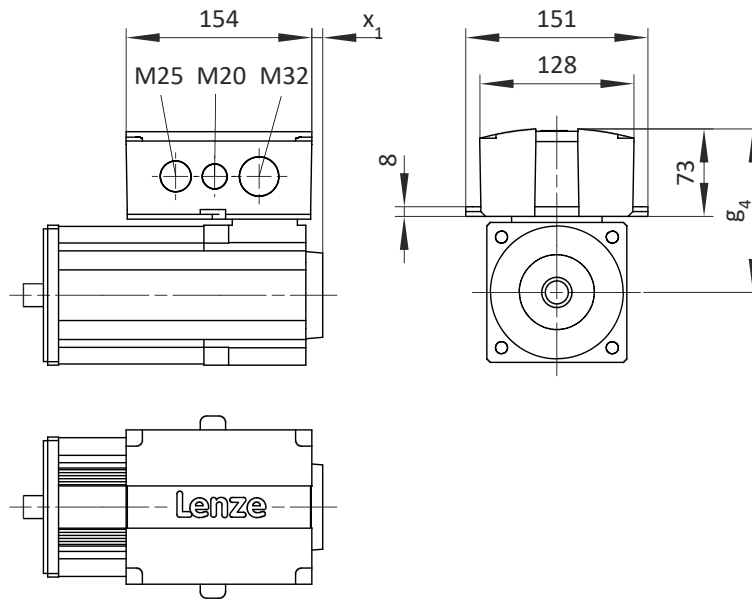

Motor			MCS09D MCS09F MCS09H MCS09L	MCS12D MCS12H MCS12L	MCS14D MCS14H MCS14L MCS14P	MCS19F MCS19J MCS19P
Motor/connection distance	g_4	mm	121	136	147	172
Feedback						
Resolver/TTL incremental encoder	x_1	mm	5	9	21	12
SinCos absolute value encoder	x_1	mm	56	58	71	61



Connection via ICN connector

The electrical connection to the servo motors as a standard is established via ICN connectors.

The connection is made via two plug connectors, one for power and brake and one for feedback and temperature monitoring. Alternatively, Lenze offers One Cable Technology (OCT).

The connectors can be rotated by 270 ° and are provided with a bayonet catch. Since the catch of the connector is also compatible with conventional box nuts, existing mating connectors with a screw plug can continue to be used without any problems.



In order to provide for a quick and error-free connection of Lenze motors to Lenze inverters, we recommend using prefabricated Lenze system cables.

One Cable Technology (OCT)

With the aid of the open motor feedback protocol HIPERFACE DSL® and the digital absolute value encoders, the motor supports the future-oriented One Cable Technology (OCT).

Advantages

- All necessary wiring is done in only one connector.
- The use of hybrid cables allows for combined servo and feedback cables.
- This intelligently minimizes connecting cables, cable variants, and connection costs.
- The motor temperature is transmitted digitally together with the encoder signal. An additional connection for a motor temperature sensor is not required.
- Speed-dependent safety functions can be implemented by using the safety-rated absolute value encoder.

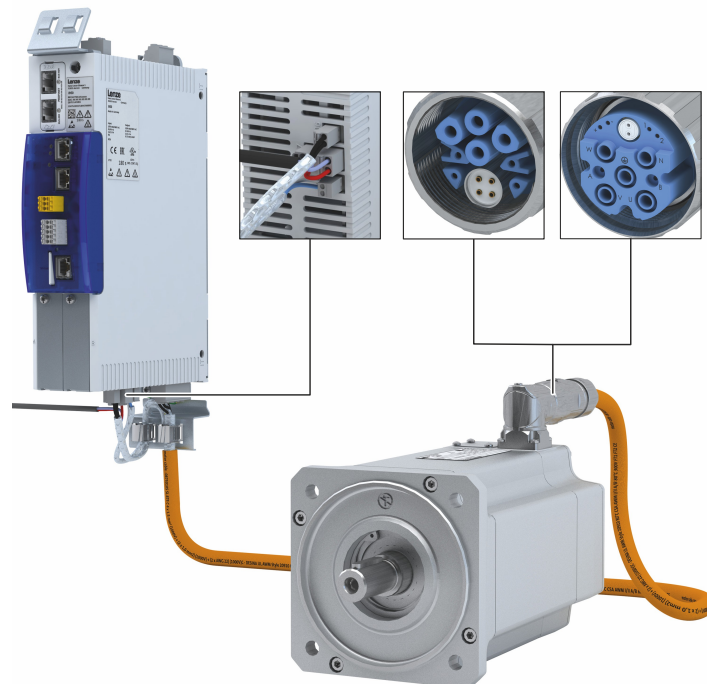

Pre-assembled hybrid cables for single-cable technology (OCT) can be found at the end of this chapter.

Product extensions

Motor connection
Connection via ICN connector



Position of the connections

Standard connection

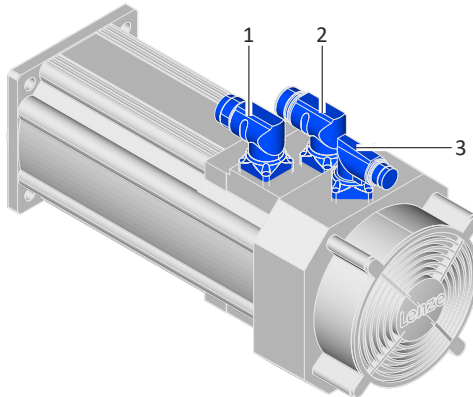

One Cable Technology (OCT)

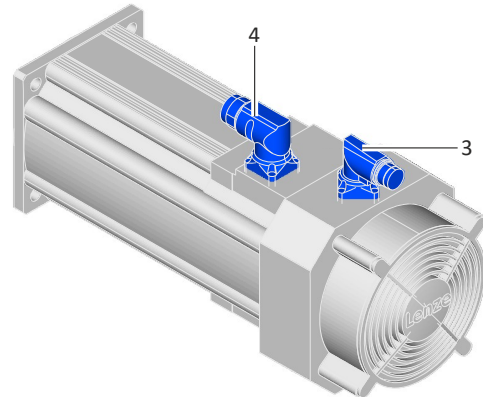

Position	Meaning	Position	Meaning
1	ICN-M23 connector, 6-pole ICN-M40 connector, 8-pole • Power connection • Brake connection • PE connection	4	For One Cable Technology (OCT) ICN-M23 connector, hybrid ICN-M40 connector, hybrid • Power connection • Brake connection • PE connection • Connection of digital absolute value encoder • Connection of temperature monitoring
2	ICN-M23 connector • Feedback connection • Connection of temperature monitoring		
3	ICN-M17 connector • Blower connection		

Motor/ICN connector assignment

Standard connection: Power and brake

One Cable Technology (OCT): Power connection, brake, feedback and temperature monitoring

Motor	Connector	Motor	Connector	Motor	Connector	Motor	Connector
MCS06...	ICN-M23	MCS14H15-	ICN-M23	MCS14P14-	ICN-M23	MCS19J14-	ICN-M23
MCS09...	ICN-M23	MCS14H28-	ICN-M40	MCS14P26-	ICN-M40	MCS19J29-	ICN-M40
MCS12...	ICN-M23	MCS14H32-	ICN-M23	MCS14P32-	ICN-M40	MCS19J30-	ICN-M40
MCS14D14-	ICN-M23	MCS14L14-	ICN-M23	MCS19F12-	ICN-M23	MCS19P12-	ICN-M40
MCS14D15-	ICN-M23	MCS14L15-	ICN-M23	MCS19F14-	ICN-M23	MCS19P14-	ICN-M40
MCS14D30-	ICN-M23	MCS14L30-	ICN-M40	MCS19F29-	ICN-M40	MCS19P29-	ICN-M40
MCS14D36-	ICN-M23	MCS14L32-	ICN-M40	MCS19F30-	ICN-M40	MCS19P30-	ICN-M40
MCS14H12-	ICN-M23	MCS14P11-	ICN-M23	MCS19J12-	ICN-M40		



Product extensions

Motor connection
Connection via ICN connector

Standard connection

Connection of power and brake

ICN-M23 connector assignment

6-pole

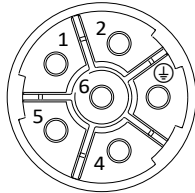

ICN M23 6-pole		
Contact	Name	Meaning
PE	PE	PE conductor
1	BD1	DC +/AC brake
2	BD2	DC -/AC brake
4	U	Power phase U
5	V	Power phase V
6	W	Power phase W

ICN-M40 connector assignment

8-pole

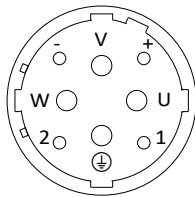

ICN M40 8-pole		
Contact	Name	Meaning
U	U	Power phase U
+	BD1	Holding brake +
-	BD2	Holding brake -
W	W	Power phase W
V	V	Power phase V
PE	PE	PE conductor
1		Not assigned
2		Not assigned

Product extensions

Motor connection
Connection via ICN connector



Feedback and temperature monitoring connection

ICN-M23 connector assignment

Resolver

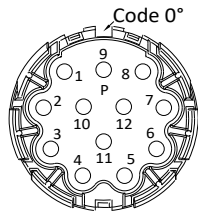

ICN M23 for resolvers		
Contact	Name	Meaning
1	+Ref	Transformer windings
2	-Ref	Transformer windings
3	+VCC ETS	Supply: Electronic nameplate (Only for motors and inverters that support this function)
4	+COS	Cosine stator windings
5	-COS	Cosine stator windings
6	+SIN	Sine stator windings
7	-SIN	Sine stator windings
8		Not assigned
9		Not assigned
10	Schirm	Encoder housing shield
11	+	Temperature monitoring: PT1000
12	-	Temperature monitoring: PT1000

ICN-M23 connector assignment

Incremental and SinCos absolute value encoder Hiperface©

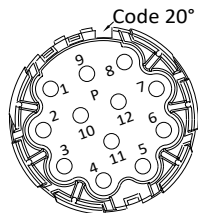

ICN M23 for incremental and SinCos absolute value encoder Hiperface		
Contact	Name	Meaning
1	B	Track B / +SIN
2	A ⁻	Track A inverse /-COS
3	A	Track A / + COS
4	+UB	Supply +
5	GND	Mass
6	Z ⁻	Zero track inverse /-RS485
7	Z	Zero track / + RS485
8		Not assigned
9	B ⁻	Track B inverse/-SIN
10	Schirm	Encoder housing shield
11	+	Temperature monitoring: PT1000
12	-	Temperature monitoring: PT1000



Product extensions

Motor connection
Connection via ICN connector

ICN-M23 connector assignment

SinCos absolute value encoder with EnDat interface

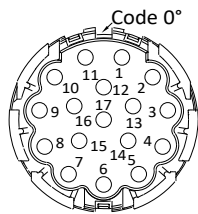

ICN M23 SinCos absolute value encoder with EnDat		
Contact	Name	Meaning
1	UP Sensor	Up Sensor
2		Not assigned
3		Not assigned
4	0 V Sensor	0 V sensor
5	+	PT1000/KTY temperature sensor
6	-	PT1000/KTY temperature sensor
7	+UB	Supply +
8	Takt	EnDat interface cycle
9	Takt-	Inverse EnDat interface cycle
10	GND	Mass
11	Schirm	Encoder housing shield
12	B	Track B
13	B-	Track B inverse/-SIN
14	Daten	EnDat interface data
15	A	Track A
16	A-	Track A inverse /-COS
17	Daten-	Data inverse EnDat interface

Blower

Pin assignment ICN-M17

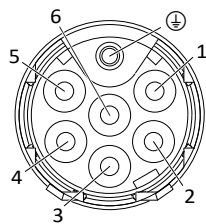

ICN M17 for blowers 1-ph		
Contact	Name	Meaning
PE	PE	PE conductor
1	U1	Fan
2	U2	Fan
3		Not assigned
4		Not assigned
5		Not assigned
6		Not assigned

Product extensions

Motor connection
Connection via ICN connector



Connector assignment

NOTICE

When making your selection, the motor data and permissible currents of the cables according to the system cable system manual must be observed.

Power terminal connectors

Plug		ICN-M23 6-pole	ICN-M40 8-pole
Motor cable	mm ²	1.0/1.5/2.5	2.5/4.0
Screw plug			
Order code		EWS0001	EWS0012
Coding in the system cable type code		M01	M02
Bayonet lock			
Order code		EWS1001	EWS1012
Coding in the system cable type code		M04	M05

Feedback connectors

Feedback	Resolver	Incremental and SinCos absolute value encoder Hiperface	SinCos absolute value encoder with EnDat interface
Plug	ICN-M23	ICN-M23	ICN-M23
Screw plug			
Order code	EWS0006	EWS0010	EWS0017
Coding in the system cable type code	F01	F02	F03
Bayonet catch			
Order code	EWS1006	EWS1010	EWS1017
Coding in the system cable type code	F05	F06	F07

Connector for blower

Blower	1-phase
Plug	ICN-M17
Screw plug	
Order code	EWS0021
Coding in the system cable type code	L02
Bayonet catch	
Order code	EWS1021
Coding in the system cable type code	L04



Product extensions

Motor connection
Connection via ICN connector

One Cable Technology (OCT)

Connection of power, brake, feedback and temperature monitoring

ICN-M23 connector assignment, hybrid

For One Cable Technology (OCT) with digital absolute value encoder

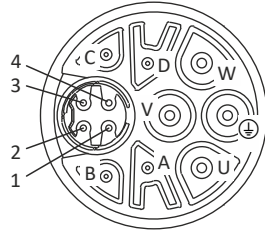

ICN M23 Hybrid for One Cable Technology (OCT) with digital absolute value encoder		
Contact	Name	Meaning
U	U	Power phase U
V	V	Power phase V
W	W	Power phase W
PE	PE	PE
A	BD1	Holding brake +
B	BD2	Holding brake -
C	+	Optional temperature monitoring: PTC +
D	-	Optional temperature monitoring: PTC -
1		Not assigned
2	+	VCC/data +
3	-	GND/data -
4		Not assigned

Product extensions

Motor connection

Connection via ICN connector



ICN-M40 connector assignment, hybrid

For One Cable Technology (OCT) with digital absolute value encoder

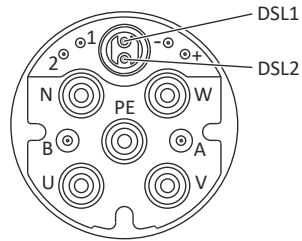

ICN M40 Hybrid for One Cable Technology (OCT) with digital absolute value encoder		
Contact	Name	Meaning
U	U	Power phase U
V	V	Power phase V
W	W	Power phase W
A	BD1	Holding brake +
B	BD2	Holding brake -
PE	PE	PE
N		Not assigned
DSL1	+	VCC/data +
DSL2	-	GND/data -
+		Not assigned
-		Not assigned
1	+	Optional temperature monitoring: PTC +
2	-	Optional temperature monitoring: PTC -



Product extensions

Motor connection
Connection via ICN connector

Hybrid cables for One Cable Technology (OCT)

Connector with bayonet lock	ICN-M23 Hybrid
Order code for hybrid cable 1.5 mm ²	
Cable length 2.0 m	EYP0080A0020M11A00
Cable length 3.5 m	EYP0080A0035M11A00
Cable length 5.0 m	EYP0080A0050M11A00
Cable length 7.5 m	EYP0080A0075M11A00
Cable length 10 m	EYP0080A0100M11A00
Cable length 15 m	EYP0080A0150M11A00
Cable length 20 m	EYP0080A0200M11A00
Cable length 50 m	EYP0080A0500M11A00
Cable length 100 m	EYP0080A1000M11A00
Order code for hybrid cable 2.5 mm ²	
Cable length 2.0 m	EYP0081A0020M11A00
Cable length 3.5 m	EYP0081A0035M11A00
Cable length 5.0 m	EYP0081A0050M11A00
Cable length 7.5 m	EYP0081A0075M11A00
Cable length 10 m	EYP0081A0100M11A00
Cable length 15 m	EYP0081A0150M11A00
Cable length 20 m	EYP0081A0200M11A00
Connector with bayonet lock	ICN-M40 Hybrid
Order code for hybrid cable 4.0 mm ²	
Cable length 2.0 m	EYP0085A0020M12A00
Cable length 3.5 m	EYP0085A0035M12A00
Cable length 5.0 m	EYP0085A0050M12A00
Cable length 7.5 m	EYP0085A0075M12A00
Cable length 10 m	EYP0085A0100M12A00
Cable length 15 m	EYP0085A0150M12A00
Cable length 20 m	EYP0085A0200M12A00
Cable length 50 m	EYP0085A0500M12A00
Cable length 100 m	EYP0085A1000M12A00
Order code for hybrid cable 6.0 mm ²	
Cable length 2.0 m	EYP0086A0020M12A00
Cable length 3.5 m	EYP0086A0035M12A00
Cable length 5.0 m	EYP0086A0050M12A00
Cable length 7.5 m	EYP0086A0075M12A00
Cable length 10 m	EYP0086A0100M12A00
Cable length 15 m	EYP0086A0150M12A00
Cable length 20 m	EYP0086A0200M12A00
Cable length 50 m	EYP0086A0500M12A00
Cable length 100 m	EYP0086A1000M12A00

Product extensions

Brakes



Brakes

Optionally, the motors can be ordered with a permanent magnet brake as holding brake.

⚠ CAUTION!

They may not be used as safety elements (particularly with hoist axes) without additional measures being implemented.

The brakes used are not fail-safe brakes in the sense that prospective disruptive factors, e.g. oil ingress, can lead to a reduction in torque!

- ▶ The brakes must only be used as holding brakes for holding the axes at a standstill or in the deenergised state.
- ▶ The brake must not be used as a service brake.

⚠ CAUTION!

If no suitable voltage (incorrect value, incorrect polarity) is applied to the brake, the brake will be applied and can be overheated and destroyed by the motor continuing to rotate.

Motor supply cables

If long motor supply cables are used, pay attention to the ohmic voltage drop along the cable and compensate for it with a higher voltage at the input end of the cable.

The following applies to Lenze system cables:

$U[V] = U_B[V] + 0.08 \frac{[V]}{[A] \times [m]} \times I_{Lg}[m] \times I_B[A]$	U	V	Resulting supply voltage
	U_B	V	Rated voltage of the brake
	I_{Lg}	m	Cable length
	I_B	A	Rated current of the brake

NOTICE

- ▶ The brakes become active when the supply voltage has been switched off (closed-circuit principle).
- ▶ When using the brakes purely as holding brakes, virtually no wear occurs on the friction surfaces.
- ▶ The friction surfaces must always be free from oil and grease because even small amounts of grease or oil will considerably reduce the braking torque.

NOTICE

In case of these permanent magnet brakes, the rated torque applies solely as holding torque at standstill.

- ▶ Emergency stops at higher speeds are possible but high switching energy increases wear on the friction surfaces and the hub.
- ▶ During braking from full motor speed, e.g. in the event of emergency stops, the braking torque is significantly reduced.



NOTICE

In case of travel axes, the compliance of the permissible ratio of mass inertia load/brake motor (J_L/J_{MB}) ensures that the permissible maximum switching energy of the brake will not be exceeded and at least the values given for the emergency stop functions from the given speed (see rated data) are applied.

For hoist axes, the load torque resulting from the weight acts additionally. In this case, the specifications for (J_L/J_{MB}) do not apply.

To simplify matters, the friction energy per switching cycle can be calculated using the formula below and must not exceed the limit value for emergency stops, which depends on the switching rate:

$Q = \frac{1}{2} \times J_{ges} \times \left(2\pi \times \frac{\Delta n}{60} \right)^2 \times \frac{M_N}{M_N - M_L}$	Q	J	Friction energy
	J_{total}	kgm ²	Total mass inertia (motor + load)
	Δn	rpm	Differential speed
	M_N	Nm	Rated torque of the brake
	M_L	nM	Load torque



The shortest operating times of the brakes are achieved by DC switching of the voltage and an external suppressor circuit (varistor or spark suppressor).

Without suppressor circuit, the operating times may increase. A varistor/ spark suppressor limits the breaking voltage peaks. It must be ensured that the power limit of the suppressor circuit is not exceeded. This limit depends on the brake current, brake voltage, disengagement time and the switching operations per time unit.

Furthermore the suppressor circuit is necessary for interference suppression and for increasing the service life of the relay contacts (external, is not integrated into the motor).



It is not possible to readjust the brake.

Product extensions

Brakes
Permanent magnet brakes



Permanent magnet brakes

Rated data

NOTICE

Engagement and disengagement times apply to rated voltage ($\pm 0\%$) and suppressor circuit of the brakes with a varistor with DC switching. Without a suppressor circuit, the times may be longer.

The currents are the maximum values when the brake is cold (value used for dimensioning the current supply). The values for a motor at operating temperature are considerably lower.

Requirements with regard to the DC 24 V brake: smoothed DC voltage, ripple $\leq 1\%$.

Maximum switching energy per emergency stop with $n = 3000$ rpm for at least 2000 emergency stops.



Product extensions

Brakes
Permanent magnet brakes

Motor			MCS06C	MCS06F	MCS06I	MCS09D		MCS09F		MCS09H
Motor code			P1	P1	P1	P1	P2	P1	P2	P1
Supply voltage range	V_{in}	V	21.84 ... 25.2							
Supply voltage	V_{rated}	V	24							
Bemessungsdrehmoment										
At 20 °C	M_{rated}	Nm	2.2			8	12	8	12	8
At 120 °C	M_{rated}	Nm	2			6	10	6	10	6
Rated current	I_{rated}	A	0.34			0.67				
Engagement time t1	t_1	ms	15			20	13	20	13	20
Disengagement time t2	t_2	ms	30			40	43	40	43	40
Friction energy	Q_E	kJ	0.030			0.400				
Weight	m	kg	0.30			0.80	0.9	0.80	0.9	0.80
Massenträgheitsmoment										
Brake	J	kgcm ²	0.12			1.07				
Brake motor	J_{MB}	kgcm ²	0.26	0.34	0.42	2.17		2.57		2.97
Load/brake motor ratio	J_L/J_{MB}		22.1	16.6	13.3	36.4		30.5		26.3

Motor			MCS09H	MCS09L		MCS12D		MCS12H		MCS12L
Motor code			P2	P1	P2	P1	P2	P1	P2	P1
Supply voltage range	V_{in}	V	21.84 ... 25.2							
Supply voltage	V_{rated}	V	24							
Bemessungsdrehmoment										
At 20 °C	M_{rated}	Nm	12	8	12	24	12	24	12	
At 120 °C	M_{rated}	Nm	10	6	10	19	10	19	10	
Rated current	I_{rated}	A	0.67				0.75	0.67	0.75	0.67
Engagement time t1	t_1	ms	13	20	13	16	13	16	13	
Disengagement time t2	t_2	ms	43	40	43	90	43	90	43	
Friction energy	Q_E	kJ	0.400				0.890	0.400	0.890	0.400
Weight	m	kg	0.9	0.80	0.9	1.20	0.9	1.20	0.9	
Massenträgheitsmoment										
Brake	J	kgcm ²	1.07				3.13	1.07	3.13	1.07
Brake motor	J_{MB}	kgcm ²	2.97	3.87		5.07	7.1	8.4	10.4	11.7
Load/brake motor ratio	J_L/J_{MB}		26.3	19.9		15	24.3	8.7	16.3	5.9

Product extensions

Brakes
Permanent magnet brakes



Motor			MCS12L	MCS14D		MCS14H		MCS14L		MCS14P
Motor code			P2	P1	P2	P1	P2	P1	P2	P1
Supply voltage range	V_{in}	V	21.84 ... 25.2							
Supply voltage	V_{rated}	V	24							
Bemessungsdrehmoment										
At 20 °C	M_{rated}	Nm	24	22	37	22	37	22	37	22
At 120 °C	M_{rated}	Nm	19	18	32	18	32	18	32	18
Rated current	I_{rated}	A	0.75		0.81	0.75	0.81	0.75	0.81	0.75
Engagement time t1	t_1	ms	16	15	96	15	96	15	96	15
Disengagement time t2	t_2	ms	90	150	113	150	113	150	113	150
Friction energy	Q_E	kJ	0.890	0.640	2.350	0.640	2.350	0.640	2.350	0.640
Weight	m	kg	1.20	1.9	3.1	1.9	3.1	1.9	3.1	1.9
Massenträgheitsmoment										
Brake	J	kgcm ²	3.13	3.2	12.4	3.2	12.4	3.2	12.4	3.2
Brake motor	J_{MB}	kgcm ²	13.7	11.3	20.5	17.4	26.6		35.8	37.9
Load/brake motor ratio	J_L/J_{MB}		12.1	10.5	22.2	6.5	16.9	3.9	12.3	2.4

Motor			MCS14P		MCS19F	MCS19J		MCS19P		
Motor code			P2		P1	P2		P2		
Supply voltage range	V_{in}	V	21.84 ... 25.2							
Supply voltage	V_{rated}	V	24							
Bemessungsdrehmoment										
At 20 °C	M_{rated}	Nm	37				95			
At 120 °C	M_{rated}	Nm	32				80			
Rated current	I_{rated}	A	0.81				1.46			
Engagement time t1	t_1	ms	96				23			
Disengagement time t2	t_2	ms	113				140			
Friction energy	Q_E	kJ	2.350				2.80			
Weight	m	kg	3.1				3.9			
Massenträgheitsmoment										
Brake	J	kgcm ²	12.4				31.8			
Brake motor	J_{MB}	kgcm ²	47.1		77	135		190		
Load/brake motor ratio	J_L/J_{MB}		9.1		5.2	2.2		1.2		



Feedback

For speed control with a servo inverter, the servo motor can be equipped with the following feedback systems:

Inverter	Feedback without functional safety		
	Resolver	Absolute value encoder	Digital absolute value encoder for OCT
i950 servo inverter	RS0	AM128-8V-H AM1024-8V-H AS1024-8V-H	AM20-8V-D
i700 servo inverter	RS0	AM128-8V-H AM1024-8V-H AS1024-8V-H	-
8400 TopLine inverter drives	RS0	AM128-8V-H AM1024-8V-H AS1024-8V-H	-
9400 HighLine servo drives	RS0	AM32-5V-E AM128-8V-H AM1024-8V-H AM2048-5V-E AS1024-8V-H AS2048-5V-E	-

Inverter	Feedback with functional safety		
	Resolver	Absolute value encoder	Digital absolute value encoder for OCT
i950 servo inverter	RV03	AM128-8V-K2 AM1024-8V-K2 AS1024-8V-K2	AM20-8V-D2
9400 HighLine servo drives	RV03	AM128-8V-K2 AM1024-8V-K2 AS1024-8V-K2	-

Feedbacks in the environment of functional safety

Motors can perform speed-dependent safety functions for safe speed and/or safe relative position monitoring in a drive system by Lenze inverters or Controllers. In case of inverters, these functions are implemented by integrable safety modules and in case of Controllers by the additionally required Safety Controller.

When planning systems/installations of this kind, always observe the following:

- When using just one single feedback system in the environment of these safety applications, the applicable safety engineering standard EN 61800-5-2 (adjustable speed electrical power drive systems - Part: 5-2: Safety requirements - Functional) stipulates special requirements for the connection between feedback system and motor shaft.
- This is due to the fact that two-channel safety systems at this point in the mechanical system are actually designed as single-channel systems. If this mechanical connection is designed with considerable overdimensioning, the standard permits exclusion of the fault "encoder-shaft breakage" or "encoder-shaft slip". As such, the permissible angular acceleration limit values must not be exceeded for the individual drive solutions.

You can find the limit values in the corresponding feedback data of the individual motor ranges.

Product extensions

Feedback
Resolver



Speed-dependent safety functions

Examples of speed-dependent safety functions:

- Safe stop 1 (SS1)
- Safe operational stop (SOS)
- Safely limited speed (SLS)
- Safe maximum speed (SMS)
- Safe direction (SDI)
- Operation mode selector (OMS) with confirmation (ES)
- Safe speed monitor (SSM)
- Safely limited increment (SLI)

Resolver

The stator-supplied, 2-pole resolver with two stator windings shifted by 90 degrees and a rotor winding with a transformer winding can record both the speed and the rotor position, just like a single-turn absolute value encoder. The rotor position can be determined within one mechanical motor revolution after a voltage failure.

Feedback type	Resolver		
Feedback			Resolver
			RS0
			RV03
Speed-dependent safety functions			No
Design			Mounting
Resolution - angle		'	0.8
Min. accuracy		'	-10
Max. accuracy		'	10
Absolute positioning			1 revolution
Max. speed	n_{\max}	rpm	8000
Max. DC input voltage	$V_{\text{in,max}}$	V	10
Max. input frequency	$f_{\text{in,max}}$	kHz	4
Ratio stator/rotor			0.3
Min ratio tolerance		%	-5
Max ratio tolerance		%	5
Rotor impedance	Z_{ro}	Ω	51+j90
Stator impedance	Z_{so}	Ω	102+j150
Impedance	Z_{rs}	Ω	44+j76
Min. insulation resistance at DC 500 V	R_{min}	M Ω	10
Number of pole pairs			1
Max. angle error Min		'	-10
Max. angle error Max		'	10

Speed-dependent safety functions

Feedback	RV03		
Motor code	RV03		
Max. permissible angular acceleration			
MCS06	α	rad/s ²	56000
MCS09 ... MCS19	α	rad/s ²	19000
Functional safety			
IEC 61508	SIL3		
EN 13849-1	Up to Performance Level e		



Product extensions

Feedback
Absolute value encoder

Absolute value encoder

Absolute value encoders can detect the speed, the rotor position, and the machine position with a very high resolution. They are used for the positioning of dynamic applications and do not require homing.



With the aid of the open feedback protocol HIPERFACE DSL[®] and in connection with the digital absolute value encoder AM20-8V-D, the motor supports the future-oriented One Cable Technology (OCT).

Product extensions

Feedback
Absolute value encoder



Feedback type			Digital absolute value encoder		SinCos absolute value encoder			
Feedback			AM20-8V-D	AM20-8V-D2	AM32-5V-E	AM128-8V-H	AM128-8V-K2	AM1024-8V-H
Speed-dependent safety functions			No	Yes	No	No	Yes	No
Design			Mounting	Mounting	Mounting	Mounting	Mounting	Mounting
Encoder type			Multi-turn	Multi-turn	Multi-turn	Multi-turn	Multi-turn	Multi-turn
Resolution		bit	20	20	-	-	-	-
Pulses			-	-	32	128	128	1024
Output signals			Digital	Digital	SinCos 1 Vss	SinCos 1 Vss	SinCos 1 Vss	SinCos 1 Vss
Interfaces			Hiperface	Hiperface	EnDat	Hiperface	Hiperface	Hiperface
Absolute revolution			4096	4096	4096	4096	4096	4096
Resolution - angle			0.02	0.02	0.4	0.4	0.4	0.4
Min. accuracy		'	-	-	-5	-1.3	-1.3	-0.8
Max. accuracy		'	-	-	5	1.3	1.3	0.8
Fehlergrenze Positionswert								
System accuracy			1.7	1.7	-	-	-	-
Integral nonlinearity			1	1	-	-	-	-
Min. DC input voltage	$V_{in,min}$	V	-	-	4.75	7	7	7
Max. DC input voltage	$V_{in,max}$	V	-	-	5.25	12	12	12
Max. current consumption	I_{max}	A	0.15	0.15	0.17	0.06	0.06	0.08
Limit frequency	f_{max}	kHz	-	-	600	200	200	200

Feedback type			SinCos absolute value encoder				
Feedback			AM1024-8V-K2	AM2048-5V-E	AS1024-8V-H	AS1024-8V-K2	AS2048-5V-E
Speed-dependent safety functions			Yes	No	No	Yes	No
Design			Mounting	Mounting	Mounting	Mounting	Mounting
Encoder type			Multi-turn	Multi-turn	Single-turn	Single-turn	Single-turn
Resolution		bit	-	-	-	-	-
Pulses			1024	2048	1024	1024	2048
Output signals			SinCos 1 Vss	SinCos 1 Vss	SinCos 1 Vss	SinCos 1 Vss	SinCos 1 Vss
Interfaces			Hiperface	EnDat	Hiperface	Hiperface	EnDat
Absolute revolution			4096	4096	1	1	1
Resolution - angle			0.4	0.4	0.4	0.4	0.4
Min. accuracy		'	-0.8	-0.6	-0.8	-0.8	-0.6
Max. accuracy		'	0.8	0.6	0.8	0.8	0.6
Fehlergrenze Positionswert							
System accuracy			-	-	-	-	-
Integral nonlinearity			-	-	-	-	-
Min. DC input voltage	$V_{in,min}$	V	7	4.75	7	7	4.75
Max. DC input voltage	$V_{in,max}$	V	12	5.25	12	12	5.25
Max. current consumption	I_{max}	A	0.08	0.25	0.08	0.08	0.15
Limit frequency	f_{max}	kHz	200	200	200	200	200



Product extensions

Blower
Absolute value encoder

Speed-dependent safety functions

Feedback			AM20-8V-D2	AM128-8V-K2	AM1024-8V-K2	AS1024-8V-K2
Motor code			EVM	SVM	SVM	SVS
Max. permissible angular acceleration						
MCS06	α	rad/s ²	240000		970000	
MCS09 ... MCS19	α	rad/s ²	240000		240000	
Functional safety						
IEC 61508					SIL2	
EN 13849-1					Up to Performance Level d	

Blower

The forced ventilation motors are cooled as a standard by means of a separate axial fan.

Rated data 50 Hz

Motor series			MCS					
Size			12		14		19	
Degree of protection			IP54					
Number of phases			1	1	1	1	1	1
Rated voltage	V _{rated}	V	115	230	115	230	115	230
Rated power	P _{rated}	kW	0.018	0.019	0.042	0.05	0.055	0.055
Rated current	I _{rated}	A	0.22	0.12	0.56	0.3	0.5	0.25

Rated data 60 Hz

Motor series			MCS					
Size			12		14		19	
Degree of protection			IP54					
Number of phases			1	1	1	1	1	1
Rated voltage	V _{rated}	V	115	230	115	230	115	230
Rated power	P _{rated}	kW	0.018	0.019	0.044	0.044	0.07	0.065
Rated current	I _{rated}	A	0.22	0.12	0.56	0.25	0.61	0.29

Product extensions

Temperature monitoring
Thermal detectors PT1000



Temperature monitoring

Thermal detectors PT1000

The thermal detector used continuously monitors the motor temperature. The temperature information is transferred to the inverter using the system cable of the feedback system. **This is not a full motor protection!**

This makes it possible to determine the motor temperature in the permissible operating range with great accuracy.

MCS06

In case of this motor, the winding temperature of a winding phase is monitored with a thermal sensor PT1000.



When supplying the thermal sensors with a measurement current of 1 mA, the connection between the temperature and the resistance measured applies.

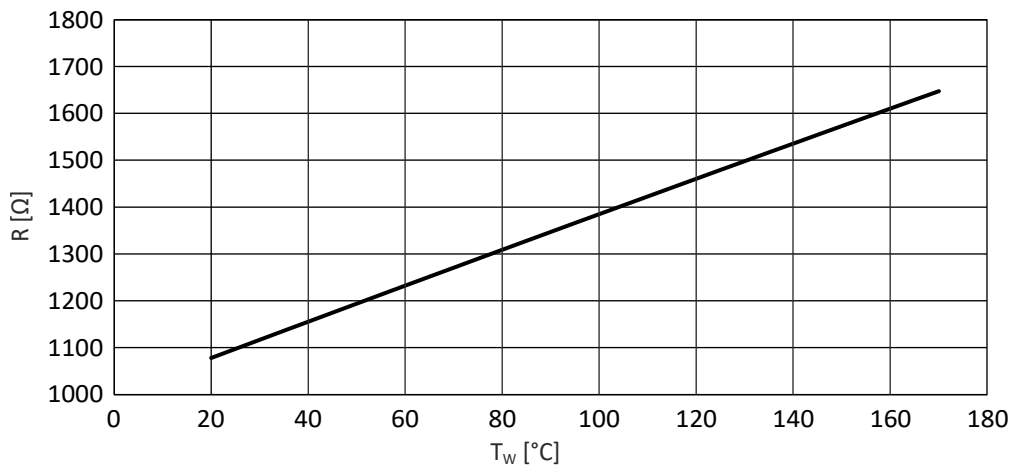

R Resistance
 T_w Winding temperature

MCS09 ... 19

These motors are monitored via three thermal sensors connected in series (1x PT1000 + 2x PTC 150 °C). This makes it possible to determine the motor temperature in the permissible operating range and at the same time execute the overtemperature response configured in the controller in one of the winding strands.



The three thermal sensors connected in series are identified on the nameplate by the short designation "PT1k+2PTC".



Product extensions

Temperature monitoring
Thermal detectors PT1000



When supplying the thermal sensors with a measurement current of 1 mA, the connection between the temperature and the resistance measured applies.

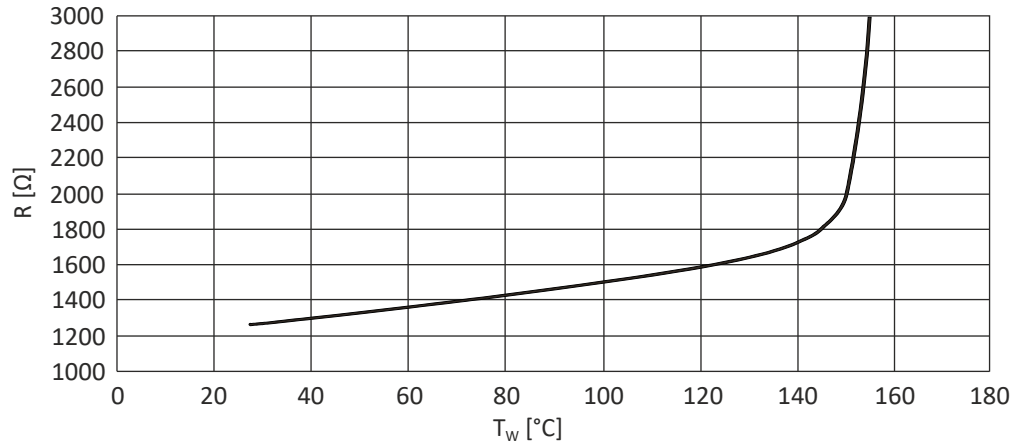

R Resistance
 T_w Winding temperature



Product codes

Product code of MCS synchronous servo motor

Example		M	C	S	06	C	41	-	RS0	B0
Meaning	Variant	Product code								
Product family	Motor	M								
Type	Compact servo motors		C							
Version	Synchronous			S						
Motor frame size	Square dimension 62 mm				06					
	Square dimension 89 mm				09					
	Square dimension 116 mm				12					
	Square dimension 142 mm				14					
	Square dimension 192 mm				19					
Overall length						C ... P				
Rated speed	rpm x 100						11 ... 60			
Inverter mains connection	3 x 230 V							L		
	3 x 400 V							-		
Feedback	SinCos absolute value encoder, single-turn, EnDat AS2048-5V-E									ECN
	Digital absolute value encoder, multi-turn, Hiperface DSL® AM20-8V-D									EKM
	SinCos absolute value encoder, multi-turn, EnDat AM32-5V-E									EQI
	SinCos absolute value encoder, multi-turn, EnDat AM2048-5V-E									EQN
	Digital safety absolute value encoder, multi-turn, Hiperface DSL® AM20-8V-D2									EVM
	Resolver p=1									RS0
	Safety resolver, p=1 RV03									RVO
	SinCos absolute value encoder, multi-turn, Hiperface® AM128-8V-H									SKM
	SinCos absolute value encoder, multi-turn, Hiperface® AM1024-8V-H									SRM
	SinCos absolute value encoder, single-turn, Hiperface® AS1024-8V-H									SRS
	SinCos safety absolute value encoder, multi-turn, Hiperface® AM128-8V-K2									SVM
	SinCos safety absolute value encoder, multi-turn, Hiperface® AM1024-8V-K2									SVM
	SinCos safety absolute value encoder, single-turn, Hiperface® AS1024-8V-K2									SVS
Brake	Without brake									B0
	Permanent magnet brake DC 24V									P1
	Permanent magnet brake DC 24V, reinforced									P2



Environmental notes and recycling

Lenze has been certified to the worldwide environmental management standard for many years (DIN EN ISO 14001). As part of our environmental policy and the associated climate responsibility, please note the following information on hazardous ingredients and the recycling of Lenze products and their packaging:



Lenze products are partly subject to the EU Directive on the restriction of certain hazardous substances in electrical and electronic equipment 2011/65/EU: RoHS Directive [UKCA: S.I. 2012/3032 - The Restriction of the Use of Certain Hazardous Substances in Electrical and Electronic Equipment Regulations 2012] . This is documented accordingly in the EU declaration of conformity and with the CE mark.



Lenze products are not subject to EU Directive 2012/19/EU: Directive on waste electrical and electronic equipment (WEEE) [UKCA: S.I. 2013/3113 - The Waste Electrical and Electronic Equipment Regulations 2013] , but some contain batteries/rechargeable batteries in accordance with EU Directive 2006/66/EC: Battery Directive [UKCA: S.I. 2009/890 - The Waste Batteries and Accumulators Regulations 2009] . The disposal route, which is separate from household waste, is indicated by corresponding labels with the "crossed-out trash can".

Any batteries/rechargeable batteries included are designed to last the life of the product and do not need to be replaced or otherwise removed by the end user.



Lenze products are usually sold with cardboard or plastic packaging. This packaging complies with EU Directive 94/62/EC: Directive on packaging and packaging waste [UKCA: S.I. 1997/648 - The Producer Responsibility Obligations (Packaging Waste) Regulations 1997] . The required disposal route is indicated by material-specific labels with the "recycling triangle".
Example: "21 - other cardboard"

REACH

Lenze products are subject to REGULATION (EC) No 1907/2006: REACH Regulation [UKCA: S.I. 2008/2852 - The REACH Enforcement Regulations 2008] . When used as intended, exposure of substances to humans, animals and the environment is excluded.

Lenze products are industrial electrical and electronic products and are disposed of professionally. Both the mechanical and electrical components such as electric motors, gearboxes or inverters contain valuable raw materials that can be recycled and reused. Proper recycling and thus maintaining the highest possible level of recyclability is therefore important and sensible from an economic and ecological point of view.

- Coordinate professional disposal with your waste disposal company.
- Separate mechanical and electrical components, packaging, hazardous waste (e.g. gear oils) and batteries/rechargeable batteries wherever possible.
- Dispose of the separated waste in an environmentally sound and proper manner (no household waste or municipal bulky waste).

What?	Material	Disposal instructions
Pallets	Wood	Return to manufacturers, freight forwarders or reusable materials collection system
Packaging material	Paper, cardboard, pasteboard, plastics	Collect and dispose of separately
Products		
Electronic devices	Metal, plastics, circuit boards, heatsinks	As electronic waste give to professional disposer for recycling
Gearbox	Oil	Drain oil and dispose of separately
	Casting, steel, aluminium	Dispose as metal scrap
Motors	Casting, copper, rotors, magnets, potting compound	As engine scrap give to professional disposer for recycling
Dry-cell batteries/rechargeable batteries		As used batteries give to professional disposer for recycling



Further information on Lenze's environmental and climate responsibility and on the topic of energy efficiency can be found on the Internet:

www.Lenze.com → search word: "Sustainability"



Appendix

Good to know

Operating modes of the motor

Operating modes S1 ... S10 as specified by EN 60034-1 describe the basic stress of an electrical machine.

In continuous operation a motor reaches its permissible temperature limit if it outputs the rated power dimensioned for continuous operation. However, if the motor is only subjected to load for a short time, the power output by the motor may be greater without the motor reaching its permissible temperature limit. This behaviour is referred to as overload capacity.

Depending on the duration of the load and the resulting temperature rise, the required motor can be selected reduced by the overload capacity.

The most important operating modes

Continuous operation S1	Short-time operation S2
<p>Operation with a constant load until the motor reaches the thermal steady state. The motor may be actuated continuously with its rated power.</p>	<p>Operation with constant load; however, the motor does not reach the thermal steady state. During the following standstill, the motor winding cools down to the ambient temperature again. The increase in power depends on the load duration.</p>



Intermittent operation S3	Non-intermittent periodic operation S6
<p>Sequence of identical duty cycles comprising operation with a constant load and subsequent standstill. Start-up and braking processes do not have an impact on the winding temperature. The steady-state is not reached. The guide values apply to a cycle duration of 10 minutes. The power increase depends on the cycle duration and on the load period/downtime ratio.</p>	<p>Sequence of identical duty cycles comprising operation with a constant load and subsequent no-load operation. The motor cools down during the no-load phase. Start-up and braking processes do not have an impact on the winding temperature. The steady-state is not reached. The guide values apply to a cycle duration of 10 minutes. The power increase depends on the cycle duration and on the load period/idle time ratio.</p>

P Power
t Time
 t_L Idle time
 ϑ Temperature

P_v Power loss
 t_B Load period
 t_S Cycle duration

Enclosures

The protection class indicates the suitability of a product for specific ambient conditions with regard to humidity as well as the protection against contact and the ingress of foreign particles. The protection classes are classified in the EN 60034-5/ EN IEC 60529.

The first code number after the code letters IP indicates the protection against the ingress of foreign particles and dust. The second code number refers to the protection against the ingress of humidity.

Code number 1	Degree of protection	Code number 2	Degree of protection
0	No protection	0	No protection
1	Protection against the ingress of foreign particles $d > 50$ mm. No protection in case of deliberate access.	1	Protection against vertically dripping water (dripping water).
2	Protection against medium-sized foreign particles, $d > 12$ mm, keeping away fingers or the like.	2	Protection against diagonally falling water (dripping water), 15° compared to normal service position.
3	Protection against small foreign particles $d > 2.5$ mm. Keeping away tools, wires or the like.	3	Protection against spraying water, up to 60° from vertical.
4	Protection against granular foreign particles, $d > 1$ mm, keeping away tools, wire or the like.	4	Protection against spraying water from all directions.
5	Protection against dust deposits (dust-protected), complete protection against contact.	5	Protection against water jets from all directions.
6	Protection against the ingress of dust (dust-proof), complete protection against contact.	6	Protection against choppy seas or heavy water jets (flood protection).

Lenze SE
Postfach 101352 · 31763 Hameln
Hans-Lenze-Straße 1 · 31855 Aerzen
GERMANY
Hannover HRB 204803
Phone +49 5154 82-0
Fax +49 5154 82-2800
sales.de@lenze.com
www.Lenze.com