

Installation Instructions

Original Instructions



Allen-Bradley

by ROCKWELL AUTOMATION

FLEX I/O 8 Relay Output Module

Catalog Numbers 1794-OW8, 1794-OW8XT

Topic	Page
Summary of Changes	1
Install Your Relay Output Module	5
Simplified Schematic of the Relay Module	6
Wiring to a 1794-TB2, 1794-TB3, or 1794-TB3S Terminal Base Unit	7
Wiring to a 1794-TBN or 1794-TBNF Terminal Base Unit	7
Install or Change a Fuse in the 1794-TBNF	8
Specifications	9

Summary of Changes

This publication contains the following new or updated information. This list includes substantive updates only and is not intended to reflect all changes. Translated versions are not always available for each revision.

Topic	Page
Updated warning statement for 1794-OW8 and 1794-OW8XT	4
Updated UK and European Hazardous Location Approval	4
Updated IEC Hazardous Location Approval	4
Updated Special Conditions for Safe Use	4
Updated General Specifications	9
Updated Certifications	10, 11



ATTENTION: Read this document and the documents listed in the Additional Resources section about installation, configuration and operation of this equipment before you install, configure, operate or maintain this product. Users are required to familiarize themselves with installation and wiring instructions in addition to requirements of all applicable codes, laws, and standards.

Activities including installation, adjustments, putting into service, use, assembly, disassembly, and maintenance are required to be carried out by suitably trained personnel in accordance with applicable code of practice. If this equipment is used in a manner not specified by the manufacturer, the protection provided by the equipment may be impaired.

注意：在安装、配置、操作和维护本产品前，请阅读本文档以及“其他资源”部分列出的有关设备安装、配置和操作的相应文档。除了所有适用规范、法律和标准的相关要求之外，用户还必须熟悉安装和接线说明。

安装、调整、投运、使用、组装、拆卸和维护等各项操作必须由经过适当训练的专业人员按照适用的操作规范实施。

如果未按照制造商指定的方式使用该设备，则可能会损害设备提供的保护。

ATENCIÓN: Antes de instalar, configurar, poner en funcionamiento o realizar el mantenimiento de este producto, lea este documento y los documentos listados en la sección Recursos adicionales acerca de la instalación, configuración y operación de este equipo. Los usuarios deben familiarizarse con las instrucciones de instalación y cableado y con los requisitos de todos los códigos, leyes y estándares vigentes. El personal debidamente capacitado debe realizar las actividades relacionadas a la instalación, ajustes, puesta en servicio, uso, ensamblaje y mantenimiento de conformidad con el código de práctica aplicable. Si este equipo se usa de una manera no especificada por el fabricante, la protección provista por el equipo puede resultar afectada.

ATENÇÃO: Leia este e os demais documentos sobre instalação, configuração e operação do equipamento que estão na seção Recursos adicionais antes de instalar, configurar, operar ou manter este produto. Os usuários devem se familiarizar com as instruções de instalação e fiação além das especificações para todos os códigos, leis e normas aplicáveis.

É necessário que as atividades, incluindo instalação, ajustes, colocação em serviço, utilização, montagem, desmontagem e manutenção sejam realizadas por pessoal qualificado e especializado, de acordo com o código de prática aplicável.

Caso este equipamento seja utilizado de maneira não estabelecida pelo fabricante, a proteção fornecida pelo equipamento pode ficar prejudicada.

ВНИМАНИЕ: Перед тем как устанавливать, настраивать, эксплуатировать или обслуживать данное оборудование, прочитайте этот документ и документы, перечисленные в разделе «Дополнительные ресурсы». В этих документах изложены сведения об установке, настройке и эксплуатации данного оборудования. Пользователи обязаны ознакомиться с инструкциями по установке и прокладке соединений, а также с требованиями всех применимых норм, законов и стандартов.

Все действия, включая установку, наладку, ввод в эксплуатацию, использование, сборку, разборку и техническое обслуживание, должны выполняться обученным персоналом в соответствии с применимыми нормами и правилами.

Если оборудование используется не предусмотренным производителем образом, защита оборудования может быть нарушена.

Если оборудование устанавливается не предусмотренным производителем образом, защита оборудования может быть нарушена. Если оборудование используется не предусмотренным производителем образом, защита оборудования может быть нарушена.

設置調整、運転の開始、使用、組立て、解体、保守を含む諸作業は、該当する実施規則に従って訓練を受けた適切な作業員が実行する必要があります。

本機器が製造メーカーにより指定されていない方法で使用されている場合、機器により提供されている保護が損なわれる恐れがあります。

ACHTUNG: Lesen Sie dieses Dokument und die im Abschnitt „Weitere Informationen“ aufgeführten Dokumente, die Informationen zu Installation, Konfiguration und Bedienung dieses Produkts enthalten, bevor Sie dieses Produkt installieren, konfigurieren, bedienen oder warten. Anwender müssen sich neben den Bestimmungen aller anwendbaren Vorschriften, Gesetze und Normen zusätzlich mit den Installations- und Verdrahtungsanweisungen vertraut machen.

Arbeiten im Rahmen der Installation, Anpassung, Inbetriebnahme, Verwendung, Montage, Demontage oder Instandhaltung dürfen nur durch ausreichend geschulte Mitarbeiter und in Übereinstimmung mit den anwendbaren Ausführungsvorschriften vorgenommen werden.

Wenn das Gerät in einer Weise verwendet wird, die vom Hersteller nicht vorgesehen ist, kann die Schutzfunktion beeinträchtigt sein.

ATTENTION : Lisez ce document et les documents listés dans la section Ressources complémentaires relatifs à l'installation, la configuration et le fonctionnement de cet équipement avant d'installer, configurer, utiliser ou entretenir ce produit. Les utilisateurs doivent se familiariser avec les instructions d'installation et de câblage en plus des exigences relatives aux codes, lois et normes en vigueur.

Les activités relatives à l'installation, le réglage, la mise en service, l'utilisation, l'assemblage, le démontage et l'entretien doivent être réalisées par des personnes formées selon le code de pratique en vigueur.

Si cet équipement est utilisé d'une façon qui n'a pas été définie par le fabricant, la protection fournie par l'équipement peut être compromise.

주의: 본 제품 설치, 설정, 작동 또는 유지 보수하기 전에 본 문서를 포함하여 설치, 설정 및 작동에 관한 참고 자료 섹션의 문서들을 반드시 읽고 숙지하십시오. 사용자는 모든 관련 규정, 법규 및 표준에서 요구하는 사항에 대해 반드시 설치 및 배선 지침을 숙지해야 합니다.

설치, 조정, 가동, 사용, 조립, 분해, 유지보수 등 모든 작업은 관련 규정에 따라 적절한 교육을 받은 사용자를 통해서만 수행해야 합니다.

본 장비를 제조사가 명시하지 않은 방법으로 사용하면 장비의 보호 기능이 손상될 수 있습니다.

ATTENZIONE Prima di installare, configurare ed utilizzare il prodotto, o effettuare interventi di manutenzione su di esso, leggere il presente documento ed i documenti elencati nella sezione "Altre risorse", riguardanti l'installazione, la configurazione ed il funzionamento dell'apparecchiatura. Gli utenti devono leggere e comprendere le istruzioni di installazione e cablaggio, oltre ai requisiti previsti dalle leggi, codici e standard applicabili.

Le attività come installazione, regolazioni, utilizzo, assemblaggio, disassemblaggio e manutenzione devono essere svolte da personale adeguatamente addestrato, nel rispetto delle procedure previste.

Qualora l'apparecchio venga utilizzato con modalità diverse da quanto previsto dal produttore, la sua funzione di protezione potrebbe venire compromessa.

DIKKAT: Bu ürünün kurulumu, yapılındırılması, işletilmesi veya bakımı öncesinde bu dokümanı ve bu ekipmanın kurulumu, yapılındırılması ve işletimi ile ilgili ilave Kaynaklar bölümünde yer listelenmiş dokümanları okuyun. Kullanıcılar yürürlükteki tüm yönetmelikler, yasalar ve standartların gereksinimlerine ek olarak kurulum ve kablolu talimatlarını da öğrenmek zorundadır.

Kurulum, ayarlama, hizmete alma, kullanma, parçaları birleştirme, parçaları sökme ve bakım gibi aktiviteler sadece uygun eğitimleri almış kişiler tarafından yürürlükteki uygulama yönetmeliklerine uygun şekilde yapılabilir.

Bu ekipman üretici tarafından belirlenmiş amacın dışında kullanılırsa, ekipman tarafından sağlanan koruma bozulabilir.

注意事項：在安装、設定、操作或維護本產品前，請先閱讀此文件以及列於「其他資源」章節中有關安裝、設定與操作此設備的文件。使用者必須熟悉安裝和配線指示，並符合所有法規、法律和標準要求。

包括安裝、調整、交付使用、使用、組裝、拆卸和維護等動作都必須交由已經過適當訓練的人員進行，以符合適用的實作法規。

如果將設備用於非製造商指定的用途時，可能會造成設備所提供的保護功能受損。

POZOR: Než začnete instalovat, konfigurovat či provozovat tento výrobek nebo provádět jeho údržbu, přečtěte si tento dokument a dokumenty uvedené v části Dodatečné zdroje ohledně instalace, konfigurace a provozu tohoto zařízení. Uživatelé se musejí vedle požadavků všech relevantních vyhlášek, zákonů a norem nutně seznámit také s pokyny pro instalaci a elektrické zapojení.

Činnosti zahrnující instalaci, nastavení, uvedení do provozu, užívání, montáž, demontáž a údržbu musí vykonávat vhodně proškolený personál v souladu s příslušnými prováděcími předpisy.

Pokud se toto zařízení používá způsobem neodpovídajícím specifikaci výrobce, může být narušena ochrana, kterou toto zařízení poskytuje.

UWAGA: Przed instalacją, konfiguracją, użytkowaniem lub konserwacją tego produktu należy przeczytać niniejszy dokument oraz wszystkie dokumenty wymienione w sekcji Dodatkowe źródła omawiające instalację, konfigurację i procedury użytkowania tego urządzenia. Użytkownicy mają obowiązek zapoznać się z instrukcjami dotyczącymi instalacji oraz oprzewodowania, jak również z obowiązującymi kodeksami, prawem i normami.

Działania obejmujące instalację, regulację, przekazanie do użytkowania, użytkowanie, montaż, demontaż oraz konserwację muszą być wykonywane przez odpowiednio przeszkolony personel zgodnie z obowiązującym kodeksem postępowania.

Jeśli urządzenie jest użytkowane w sposób inny niż określony przez producenta, zabezpieczenie zapewniane przez urządzenie może zostać ograniczone.

Obs! Läs detta dokument samt dokumentet, som står listat i avsnittet Övriga resurser, om installation, konfigurering och drift av denna utrustning innan du installerar, konfigurerar eller börjar använda eller utföra underhållsarbete på produkten. Användare måste bekanta sig med instruktioner för installation och kabeldragning, förutom krav enligt gällande koder, lagar och standarder.

Åtgärder som installation, justering, service, användning, montering, demontering och underhållsarbete måste utföras av personal med lämplig utbildning enligt lämpligt bruk.

Om denna utrustning används på ett sätt som inte anges av tillverkaren kan det hända att utrustningens skyddsanordningar försätts ur funktion.

LET OP: Lees dit document en de documenten die genoemd worden in de paragraaf Aanvullende informatie over de installatie, configuratie en bediening van deze apparatuur voordat u dit product installeert, configureert, bedient of onderhoudt. Gebruikers moeten zich vertrouwd maken met de installatie en de bedringsinstructies, naast de vereisten van alle toepasselijke regels, wetten en normen.

Activiteiten zoals het installeren, afstellen, in gebruik stellen, gebruiken, monteren, demonteren en het uitvoeren van onderhoud mogen uitsluitend worden uitgevoerd door hiervoor opgeleid personeel en in overeenstemming met de geldende praktijkregels.

Indien de apparatuur wordt gebruikt op een wijze die niet is gespecificeerd door de fabrikant, dan bestaat het gevaar dat de beveiliging van de apparatuur niet goed werkt.

Environment and Enclosure



ATTENTION: This equipment is intended for use in a Pollution Degree 2 industrial environment, in overvoltage Category II applications (as defined in EN/IEC 60664-1), at altitudes up to 2000 m (6562 ft) without derating. This equipment is not intended for use in residential environments and may not provide adequate protection to radio communication services in such environments.

This equipment is supplied as open-type equipment for indoor use. It must be mounted within an enclosure that is suitably designed for those specific environmental conditions that will be present and appropriately designed to prevent personal injury resulting from accessibility to live parts. The enclosure must have suitable flame-retardant properties to prevent or minimize the spread of flame, complying with a flame spread rating of 5V A or be approved for the application if nonmetallic. The interior of the enclosure must be accessible only by the use of a tool. Subsequent sections of this publication may contain more information regarding specific enclosure type ratings that are required to comply with certain product safety certifications.

In addition to this publication, see the following:

- Industrial Automation Wiring and Grounding Guidelines, publication [1770-4.1](#), for additional installation requirements.
- NEMA Standard 250 and EN/IEC 60529, as applicable, for explanations of the degrees of protection provided by enclosures.





ATTENTION: This product is grounded through the DIN rail to chassis ground. Use zinc-plated chromate-passivated steel DIN rail to assure proper grounding. The use of other DIN rail materials (for example, aluminum or plastic) that can corrode, oxidize, or are poor conductors, can result in improper or intermittent grounding. Secure DIN rail to mounting surface approximately every 200 mm (7.8 in.) and use end-anchors appropriately. Be sure to ground the DIN rail properly. See the Industrial Automation Wiring and Grounding Guidelines, Rockwell Automation publication [1770-4.1](#), for more information.



ATTENTION: If this equipment is used in a manner not specified by the manufacturer, the protection provided by the equipment may be impaired.

North American Hazardous Location Approval

The Following Information Applies When Operating This Equipment In Hazardous Locations.	Informations sur l'utilisation de cet équipement en environnements dangereux.
<p>Products marked "CL I, DIV 2, GP A, B, C, D" are suitable for use in Class I Division 2 Groups A, B, C, D, Hazardous Locations and nonhazardous locations only. Each product is supplied with markings on the rating nameplate indicating the hazardous location temperature code. When combining products within a system, the most adverse temperature code (lowest "T" number) may be used to help determine the overall temperature code of the system. Combinations of equipment in your system are subject to investigation by the local Authority Having Jurisdiction at the time of installation.</p>	<p>Les produits marqués "CL I, DIV 2, GP A, B, C, D" ne conviennent qu'à une utilisation en environnements de Classe I Division 2 Groupes A, B, C, D dangereux et non dangereux. Chaque produit est livré avec des marquages sur sa plaque d'identification qui indiquent le code de température pour les environnements dangereux. Lorsque plusieurs produits sont combinés dans un système, le code de température le plus défavorable (code de température le plus faible) peut être utilisé pour déterminer le code de température global du système. Les combinaisons d'équipements dans le système sont sujettes à inspection par les autorités locales qualifiées au moment de l'installation.</p>
<div style="display: flex; align-items: flex-start;"> <div style="margin-right: 10px;">  </div> <div> <p>WARNING: Explosion Hazard -</p> <ul style="list-style-type: none"> • Do not disconnect equipment unless power has been removed or the area is known to be nonhazardous. • Do not disconnect connections to this equipment unless power has been removed or the area is known to be nonhazardous. Secure any external connections that mate to this equipment by using screws, sliding latches, threaded connectors, or other means provided with this product. • Substitution of components may impair suitability for Class I, Division 2. </div> </div>	<div style="display: flex; align-items: flex-start;"> <div style="margin-right: 10px;">  </div> <div> <p>AVERTISSEMENT: Risque d'Explosion -</p> <ul style="list-style-type: none"> • Couper le courant ou s'assurer que l'environnement est classé non dangereux avant de débrancher l'équipement. • Couper le courant ou s'assurer que l'environnement est classé non dangereux avant de débrancher les connecteurs. Fixer tous les connecteurs externes reliés à cet équipement à l'aide de vis, loquets coulissants, connecteurs filetés ou autres moyens fournis avec ce produit. • La substitution de composants peut rendre cet équipement inadapté à une utilisation en environnement de Classe I, Division 2. </div> </div>

Preventing Electrostatic Discharge



ATTENTION: This equipment is sensitive to electrostatic discharge, which can cause internal damage and affect normal operation. Follow these guidelines when you handle this equipment:

- Touch a grounded object to discharge potential static.
- Wear an approved grounding wriststrap.
- Do not touch connectors or pins on component boards.
- Do not touch circuit components inside the equipment.
- Use a static-safe workstation, if available.
- Store the equipment in appropriate static-safe packaging when not in use.



ATTENTION: If you connect or disconnect wiring while the field-side power is on, an electrical arc can occur. This could cause an explosion in hazardous location installations. Be sure that power is removed or the area is nonhazardous before proceeding.



ATTENTION: Personnel responsible for the application of safety-related programmable electronic systems (PES) shall be aware of the safety requirements in the application of the system and shall be trained in using the system.



ATTENTION: Do not remove or replace a Terminal Base unit while power is applied. Interruption of the backplane can result in unintentional operation or machine motion.



ATTENTION: To comply with the CE Low Voltage Directive (LVD), this equipment must be powered from a source compliant with the following: Safety Extra Low Voltage (SELV) or Protected Extra Low Voltage (PELV).



WARNING: Modules 1794-OW8 and 1794-OW8XT are not approved for use above 60V AC in ATEX/IECEX/UKEX applications.

UK and European Hazardous Location Approval

The following applies to products marked  II 3 G:

- Are Equipment Group II, Equipment Category 3, and comply with the Essential Health and Safety Requirements relating to the design and construction of such equipment given in Schedule 1 of UKEX and Annex II of EU Directive 2014/34/EU. See the UKEX and EU Declaration of Conformity at rok.auto/certifications for details.
- The type of protection is Ex ec nC IIC T4 Gc according to EN IEC 60079-0:2018, EXPLOSIVE ATMOSPHERES - PART 0: EQUIPMENT - GENERAL REQUIREMENTS, Issue Date 07/2018, EN IEC 60079-7:2015+A1:2018, Explosive atmospheres, Equipment protection by increased safety "e" & EN IEC 60079-15:2019 Explosive atmospheres, Equipment protection by type protection "n".
- Comply to Standard EN IEC 60079-0:2018, EXPLOSIVE ATMOSPHERES - PART 0: EQUIPMENT - GENERAL REQUIREMENTS, Issue Date 07/2018, EN IEC 60079-7:2015+A1:2018 Explosive atmospheres. Equipment protection by increased safety "e" & EN IEC 60079-15:2019 Explosive atmospheres, Equipment protection by type protection "n", reference certificate number DEMKO 14 ATEX 1342501X and UL22UKEX2378X.
- Are intended for use in areas in which explosive atmospheres caused by gases, vapors, mists, or air are unlikely to occur, or are likely to occur only infrequently and for short periods. Such locations correspond to Zone 2 classification according to UKEX regulation 2016 No. 1107 and ATEX directive 2014/34/EU.

IEC Hazardous Location Approval

The following applies to products marked with IECEx certification:

- Are intended for use in areas in which explosive atmospheres caused by gases, vapors, mists, or air are unlikely to occur, or are likely to occur only infrequently and for short periods. Such locations correspond to Zone 2 classification to IEC 60079-0.
- The type of protection is Ex ec nC IIC T4 Gc according to IEC 60079-0, IEC 60079-7 and IEC 60079-15.
- Comply to Standards IEC 60079-0, Explosive atmospheres - Part 0: Equipment - General requirements, Edition 7, Revision Date 2017, IEC 60079-7, 5.1 Edition revision date 2017, Explosive atmospheres - Part 7: Equipment protection by increased safety "e" and IEC 60079-15, 5.0 Edition revision date 2017, Explosive atmospheres - Part 15: Equipment protection by type protection "n", reference IECEx certificate number IECEx UL 14.0066X.



WARNING: Special Conditions for Safe Use:

- This equipment shall be mounted in an UKEX/ATEX/IECEX Zone 2 certified enclosure with a minimum ingress protection rating of at least IP54 (in accordance with EN/IEC 60079-0) and used in an environment of not more than Pollution Degree 2 (as defined in EN/IEC 60664-1) when applied in Zone 2 environments. The enclosure must be accessible only by the use of a tool.
- This equipment shall be used within its specified ratings defined by Rockwell Automation.
- Transient protection shall be provided that is set at a level not exceeding 140% of the peak rated voltage value at the supply terminals to the equipment.
- The instructions in the user manual shall be observed.
- This equipment must be used only with UKEX/ATEX/IECEX certified Rockwell Automation backplanes.
- Secure any external connections that mate to this equipment by using screws, sliding latches, threaded connectors, or other means provided with this product.
- Do not disconnect equipment unless power has been removed or the area is known to be nonhazardous.
- Earthing is accomplished through mounting of modules on rail.
- Modules 1794-OW8 and 1794-OW8XT must be used at or below 60V AC.

Install Your Relay Output Module

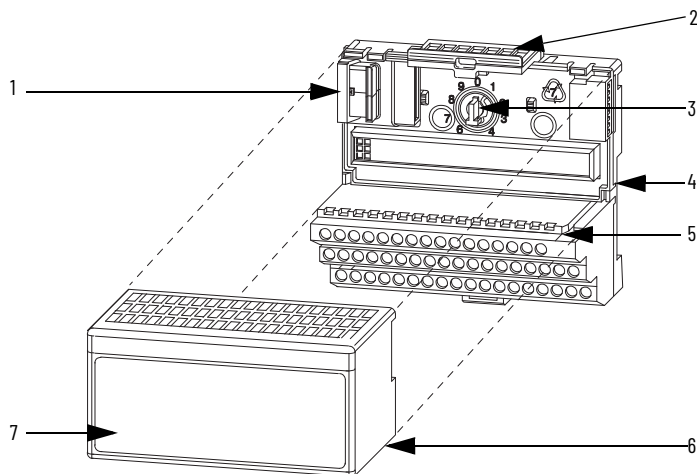

Component Identification

	Description		Description
1	Flexbus connectors	5	Groove
2	Latching mechanism	6	Alignment bar
3	Keyswitch	7	Module
4	Terminal base		



ATTENTION: During mounting of all devices, be sure that all debris (for example, metal chips and wire strands) is kept from falling into the module. Debris that falls into the module could cause damage on power-up.



ATTENTION: Allow 25.4 mm (1 in.) of space between adjacent equipment for adequate ventilation.

The FLEX™ I/O relay output module mounts on a 1794 terminal base.

1. Rotate the keyswitch (3) on the terminal base (4) clockwise to position 9 as required for this type of module.
2. Make certain the Flexbus connector (1) is pushed all the way to the left to connect with the neighboring terminal base and adapter. **You cannot install the module unless the connector is fully extended.**
3. Make sure the pins on the bottom of the module are straight so they align properly with the connector in the terminal base.



WARNING: If you remove or insert the module while the backplane power is on, an electrical arc can occur. This could cause an explosion in hazardous location installations. Be sure that power is removed or the area is nonhazardous before proceeding.

4. Position the module (7) with its alignment bar (6) aligned with the groove (5) on the terminal base.
5. Press firmly and evenly to seat the module in the terminal base unit. The module is seated when the latching mechanism (4) is locked into the module.



WARNING: Exposure to some chemicals may degrade the sealing properties of materials used in the following devices:
Relay K1 through K8, Epoxy.
We recommended that you periodically inspect these devices for any degradation of properties and replace the module if degradation is found.

Simplified Schematic of the Relay Module

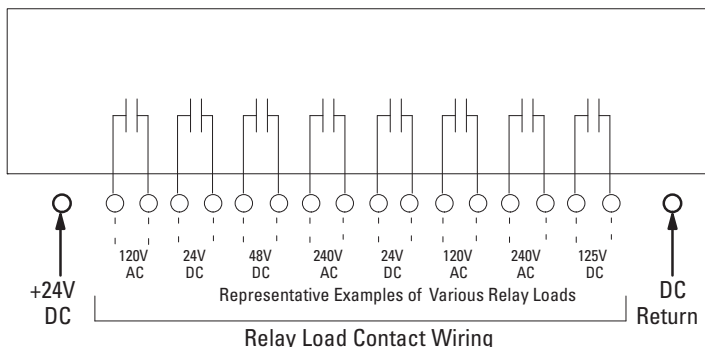

Load power can be obtained from a variety of sources, and can range from +5V...240V AC. Make certain that only 24V DC is applied to the module power terminals on the module terminal base unit.

If you are using 220/240V AC power, you must use the 1794-TBN or 1794-TBNF terminal base unit. Maximum voltage allowed is shown below.

Working Voltage and Isolation Voltage Ratings

Terminal Base	24V	120V	230V	Isolation Voltage
1794-TBN, 1794-TBNK, 1794-TBNF, 1794-TBNFK	AC/DC	AC/DC	AC/DC	Dependent upon installed module - refer to individual installation instructions for your specific module.
1794-TB2, 1794-TB3, 1794-TB3K, 1794-TB3S	AC/DC	AC/DC		
1794-TB3T, 1794-TB3TS	AC/DC	AC/DC		
1794-TB3G, 1794-TB3GK, 1794-TB3GS	AC/DC			
1794-TB32, 1794-TB32S	AC/DC			
1794-TBKD	DC	AC		



ATTENTION: If multiple power sources are used, do not exceed the specified isolation voltage.



ATTENTION: Apply only 24V DC power to the power terminals on the terminal base unit. Make certain that **all** relay wiring is properly connected before applying any power to the module.



ATTENTION: Total current through the terminal base unit is limited to 10 A. Separate power connections to the terminal base unit may be necessary.



ATTENTION: Do not attempt to increase load current or wattage capability beyond the maximum rating by connecting 2 or more outputs in parallel. The slightest variation in relay switching time may cause one relay to momentarily switch the total load current.

Wiring to a 1794-TB2, 1794-TB3, or 1794-TB3S Terminal Base Unit

1. Connect individual output relay contact (customer load) wiring to numbered terminals on the **0...15 row (A)** as indicated in the table below. The even-numbered terminals are one pole of the relay contacts; the odd-numbered terminals are the other pole of the relay contacts.
2. Connect 24V DC return to terminal 16 on the **16...33 row (B)**.
3. Connect +24V DC power to terminal 34 on the **34...51 row (C)**.



ATTENTION: Apply only 24V DC power to the power terminals on the terminal base unit. Make certain that **all** relay wiring is properly connected before applying any power to the module.

4. If daisy chaining power to the next terminal base, connect a jumper from terminal 51 (+V DC) on this base unit to terminal 34 on the next base unit.
5. If continuing DC common to the next base unit, connect a jumper from terminal 33 (common) on this base unit to terminal 16 on the next base unit.

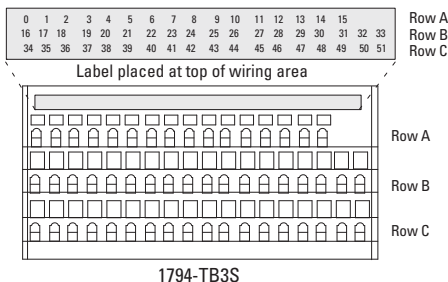
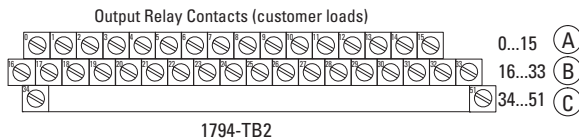

Wiring to a 1794-TBN or 1794-TBNF Terminal Base Unit

1. Connect individual output relay contact (customer load) to even-numbered terminals 0...14 on row (B) and odd-numbered terminals 1...15 on row (C) as indicated in the table below. The even-numbered terminals are one pole of the relay contacts; the odd-numbered terminals are the other pole of the relay contacts.



ATTENTION: When using 240V power to a relay, you must connect a snubber across the load. Failure to connect a snubber across the load (relay contacts) can result in generation of electromagnetic noise, which could disrupt nearby electrical equipment, including your FLEX I/O chassis. Use Allen-Bradley® part number 599-KA04 or 1401-NX1.

2. Connect 24V DC return to terminal 16 on the **16...33 row (B)**.
3. Connect +24V DC power to terminal 34 on the **34...51 row (C)**.
4. If daisy chaining power to the next terminal base, connect a jumper from terminal 51 (+V DC) on this base unit to terminal 34 on the next base unit.
5. If continuing DC common to the next base unit, connect a jumper from terminal 33 (common) on this base unit to terminal 16 on the next base unit.

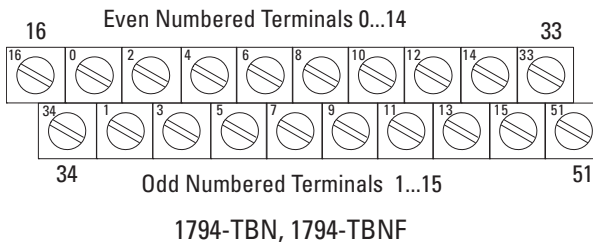

Wiring Connections for the 1794-0W8, 1794-0W8XT

Output Channel	1794-TB2, 1794-TB3, 1794-TB3S	1794-TBN, 1794-TBNF
	Output Terminal	Output Terminal
0	A-0	B-0
	A-1	C-1
1	A-2	B-2
	A-3	C-3
2	A-4	B-4
	A-5	C-5
3	A-6	B-6
	A-7	C-7
4	A-8	B-8
	A-9	C-9
5	A-10	B-10
	A-11	C-11
6	A-12	B-12
	A-13	C-13
7	A-14	B-14
	A-15	C-15
	A-(even) = one contact of the relay A-(odd) = the other contact of the relay	B-(even) = one contact of the relay C-(odd) = the other contact of the relay
+24V DC	C-34...C-51 (1794-TB3, 1794-TB3S) C-34 and C-51 (1794-TB2)	C-34 and C-51
-24V DC (RET)	B-16...B-33	B-16 and B-33

Image Table Memory Map

Dec.	15	14	13	12	11	10	09	08	07	06	05	04	03	02	01	00
Oct.	17	16	15	14	13	12	11	10	07	06	05	04	03	02	01	00
Read Word	Not used - reserved															
Write Word	Not used - set to 0								07	06	05	04	03	02	01	00
Where:	0 = Output number (00 corresponds to output 0, 01 corresponds to output 1, and so on) When bit = 0, output 0 is off; when bit = 1, output 0 is on.															



WARNING: The 1794-TBNF and 1794-TBNFK are not approved for use in Class I Division 2 applications.

Install or Change a Fuse in the 1794-TBNF

This terminal base unit has fuse holders for 5 x 20 mm fuses on each of the 8 even-numbered I/O terminals 0...14 (row B). To install or change a fuse:

1. Press the fuse holder down toward the terminal strip.

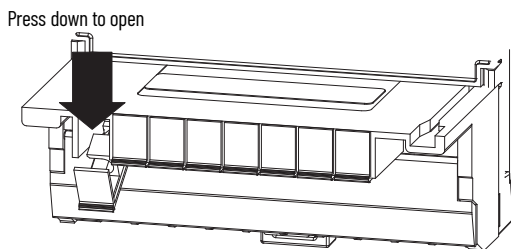

2. If replacing a fuse, remove the fuse from the fuse holder.
3. Insert a known good 5 x 20 mm fuse (Littelfuse part number 239003, 3.0 A, 250V AC slow-blow) into the fuse holder.
4. Replace the fuse holder by rotating the fuse holder back to vertical until it snaps into the locked position.

Specifications

General Specifications

Attribute	Value
Outputs per module	1 group of 8 Form A isolated (normally open) electromechanical relays
Module location	Mounts on 1794-TB2, 1794-TB3, 1794-TB3S, 1794-TBN, and 1794-TBNF Terminal Base Units. When using 1794-TBNF terminal base unit, use 3.0 A, 250V AC slow-blow fuses (Littelfuse part number 239003)
Off-State leakage current (max at 240V AC)	1.0 mA through snubber circuit
Minimum contact load	100 μ A @ 100 mV DC
Flexbus current	5V DC, 35 mA
Supply voltage	24V DC, 125 mA - 1794-OW8 19.2...31.2V DC, 125 mA - 1794-OW8XT
Relay contact	250V AC, 2 A, 50/60 Hz, Resistive; 120/240V AC, 50/60 Hz, 1800V A Make, 180V A Break; 5...30V DC, 2 A, Resistive;
Pilot duty rating	R150, 5...30V DC, 28V A not to exceed 1 A below 28V DC
Output signal delay OFF to ON	10 ms max (time from valid output on signal to relay energization by module)
ON to OFF	10 ms max (time from valid output off signal to relay de-energization by module)
Initial contact resistance	30 m Ω
Switching frequency	1 operation/3 s (0.3 Hz at rated load) max
Bounce time	1.2 ms (mean)
Expected life of electrical contacts	100,000 operations, min @ rated loads
Thermal dissipation	18.8 BTU/hr max
Power dissipation	5.5 W
Isolation voltage	250V (continuous), Basic Insulation Type, relay to relay, relay to backplane, and relay to power 50V (continuous), Basic Insulation Type, power to backplane Type tested at 1500V AC for 60 s, relay to relay, all combinations Type tested at 3250V DC for 60 s, relay to backplane and relay to power Type tested at 720V DC for 60 s, power to backplane
Fusing	Fusing of outputs is recommended. Use 3.0 A, 250V AC slow-blow fuses (Littelfuse part number 239003).
Indicators	8 yellow status indicators
Keyswitch position	9
Terminal screw torque	Determined by installed terminal base
Dimensions (HxWxD), approx	94 x 94 x 69 mm (3.7 x 3.7 x 2.7 in.) (with module installed)
Enclosure	None (open-style)
Wiring category ⁽¹⁾	2 - on signal ports
Wire size	Determined by installed terminal base
North American temp code	T4 - 1794-OW8XT T5 - 1794-OW8
ATEX/UKEX temp code	T4
IECEX temp code	T4

(1) Use this Conductor Category information for planning conductor routing. See the Industrial Automation Wiring and Grounding Guidelines, publication [1770-4.1](#).

Environmental Specifications

Attribute	Value
Temperature, operating	IEC 60068-2-1 (Test Ad, Operating Cold), IEC 60068-2-2 (Test Bd, Operating Dry Heat), IEC 60068-2-14 (Test Nb, Operating Thermal Shock): -20...+70 °C (-4...+158 °F) - 1794-OW8XT -20...+55 °C (-4...+131 °F) - 1794-OW8
Temperature, nonoperating	IEC 60068-2-1 (Test Ab, Unpackaged nonoperating Cold), IEC 60068-2-2 (Test Bb, Unpackaged nonoperating Dry Heat), IEC 60068-2-14 (Test Na, Unpackaged nonoperating Thermal Shock): -40...+85 °C (-40...+185 °F)
Temperature, surrounding air, max	55 °C (131 °F) - 1794-OW8 70 °C (158 °F) - 1794-OW8XT
Relative humidity	IEC 60068-2-30 (Test Db, Unpackaged Damp Heat): 5...95% noncondensing
Vibration	IEC 60068-2-6 (Test Fc, Operating): 5 g @ 10...500 Hz
Shock, operating	IEC 60068-2-27 (Test Ea, Unpackaged Shock): 12 g
Shock, nonoperating	IEC 60068-2-27 (Test Ea, Unpackaged Shock): 50 g
Emissions	IEC 61000-6-4
ESD immunity	IEC 61000-4-2: 6 kV contact discharges 8 kV air discharges
Radiated RF immunity	IEC 61000-4-3: 10V/m with 1 kHz sine-wave 80% AM from 80...6000 MHz
EFT/B immunity	IEC 61000-4-4: ±2 kV at 5 kHz on signal ports
Surge transient immunity	IEC 61000-4-5: ±1 kV line-line(DM) and ±2 kV line-earth(CM) on signal ports
Oscillatory surge withstand	IEEE C37.90.1: 2.5 kV
Conducted RF immunity	IEC 61000-4-6: 10V rms with 1 kHz sine-wave 80% AM from 150 kHz...80 MHz

Certifications

Certifications (when product is marked) ⁽¹⁾	Value
c-UL-us	UL Listed Industrial Control Equipment, certified for US and Canada. See UL File E65584. UL Listed for Class I, Division 2 Group A,B,C,D Hazardous Locations, certified for U.S. and Canada. See UL File E194810.
UK and CE	UK Statutory Instrument 2016 No. 1091 and European Union 2014/30/EU EMC Directive, compliant with: EN 61326-1; Meas./Control/Lab., Industrial Requirements EN 61000-6-2; Industrial Immunity EN 61131-2; Programmable Controllers EN 61000-6-4; Industrial Emissions UK Statutory Instrument 2016 No. 1101 and European Union 2014/35/EU LVD, compliant with: EN 61131-2; Programmable Controllers (Clause 11) UK Statutory Instrument 2012 No. 3032 and European Union 2011/65/EU RoHS, compliant with: EN 63000; Technical documentation
Ex	UK Statutory Instrument 2016 No. 1107 and European Union 2014/34/EU ATEX Directive, compliant with: EN IEC 60079-0; General Requirements EN IEC 60079-7; Explosive Atmospheres, Protection "e" EN IEC 60079-15; Potentially Explosive Atmospheres, Protection "n" II 3 G Ex ec nC IIC T4 Gc DEMKO 14 ATEX 1342501X UL22UKEX2378X when used at or below 60V AC

Certifications (Continued)

Certifications (when product is marked) ⁽¹⁾	Value
IECEX	IECEX System, compliant with: IEC 60079-0; General Requirements IEC 60079-7; Explosive Atmospheres, Protection "e" IEC 60079-15; Potentially Explosive Atmospheres, Protection "n" Ex ec nC IIC T4 Gc IECEX UL 14.0066X when used at or below 60V AC
RCM	(1794-0W8, 1794-0W8XT) Australian Radiocommunications Act, compliant with: EN 61000-6-4; Industrial Emissions
KC	Korean Registration of Broadcasting and Communications Equipment, compliant with: Article 58-2 of Radio Waves Act, Clause 3
TÜV	TÜV Certified for Functional Safety: capable of SIL 2
EAC	Russian Customs Union TR CU 020/2011 EMC Technical Regulation Russian Customs Union TR CU 004/2011 LV Technical Regulation
Morocco	Arrêté ministériel n° 6404-15 du 29 ramadan 1436 Arrêté ministériel n° 6404-15 du 1 er muharram 1437
CCC	CNCA-C23-01 强制性产品认证实施规则 防爆电气 CNCA-C23-01 CCC Implementation Rule Explosion-Proof Electrical Products

(1) See the Product Certification link at rok.auto/certifications for Declaration of Conformity, Certificates, and other certification details.

Rockwell Automation Support

Use these resources to access support information.

Technical Support Center	Find help with how-to videos, FAQs, chat, user forums, Knowledgebase, and product notification updates.	rok.auto/support
Local Technical Support Phone Numbers	Locate the telephone number for your country.	rok.auto/phonesupport
Technical Documentation Center	Quickly access and download technical specifications, installation instructions, and user manuals.	rok.auto/techdocs
Literature Library	Find installation instructions, manuals, brochures, and technical data publications.	rok.auto/literature
Product Compatibility and Download Center (PCDC)	Download firmware, associated files (such as AOP, EDS, and DTM), and access product release notes.	rok.auto/pcdc

Documentation Feedback

Your comments help us serve your documentation needs better. If you have any suggestions on how to improve our content, complete the form at rok.auto/docfeedback.





Waste Electrical and Electronic Equipment (WEEE)



At the end of life, this equipment should be collected separately from any unsorted municipal waste.

Rockwell Automation maintains current product environmental compliance information on its website at rok.auto/pec.

Rockwell Otomasyon Ticaret A.Ş. Kar Plaza İş Merkezi E Blok Kat:6 34752 İçerenköy, İstanbul, Tel: +90 (216) 5698400 EEE Yönetmeliğine Uygundur

Connect with us.    

rockwellautomation.com — expanding **human possibility**[®]

AMERICAS: Rockwell Automation, 1201 South Second Street, Milwaukee, WI 53204-2496 USA, Tel: (1) 414.382.2000, Fax: (1) 414.382.4444

EUROPE/MIDDLE EAST/AFRICA: Rockwell Automation NV, Pegasus Park, De Kleetlaan 12a, 1831 Diegem, Belgium, Tel: (32) 2 663 0600, Fax: (32) 2 663 0640

ASIA PACIFIC: Rockwell Automation, Level 14, Core F, Cyberport 3, 100 Cyberport Road, Hong Kong, Tel: (852) 2887 4788, Fax: (852) 2508 1846

UNITED KINGDOM: Rockwell Automation Ltd. Pitfield, Kiln Farm Milton Keynes, MK11 3DR, United Kingdom, Tel: (44)(1908) 838-800, Fax: (44)(1908) 261-917

Allen-Bradley, expanding human possibility, FactoryTalk, FLEX, Rockwell Automation, and TechConnect are trademarks of Rockwell Automation, Inc. Trademarks not belonging to Rockwell Automation are property of their respective companies.

Publication 1794-IN019J-EN-P - October 2022 | Supersedes Publication 1794-IN019I-EN-P - November 2021

Copyright © 2022 Rockwell Automation, Inc. All rights reserved.