

## SX0A-B0905B

Other connectors and cables

**PLUG CONNECTORS AND CABLES**

**SICK**  
Sensor Intelligence.



Illustration may differ

### Ordering information

Type	Part no.
SX0A-B0905B	2027170

Other models and accessories → [www.sick.com/Other\\_connectors\\_and\\_cables](http://www.sick.com/Other_connectors_and_cables)

### Detailed technical data

#### Technical specifications

<b>Accessory group</b>	Plug connectors and cables
<b>Accessory family</b>	Other connectors and cables
<b>Connection type head A</b>	System plug
<b>Connection type</b>	Flying leads
<b>Cable</b>	5 m, 9-wire, PVC
<b>Jacket material</b>	PVC
<b>Shielding</b>	Unshielded
<b>Special feature</b>	Pre-assembled, Not for use of incremental encoders, integrated configuration storage
<b>Items supplied</b>	With 1 x cable gland M20, 1 x blanking plug M20, 2 x blanking plug M12
<b>Description</b>	For S3000 Standard and Remote

#### Classifications

<b>ECLASS 5.0</b>	27279290
<b>ECLASS 5.1.4</b>	27279290
<b>ECLASS 6.0</b>	27279221
<b>ECLASS 6.2</b>	27279221
<b>ECLASS 7.0</b>	27440104
<b>ECLASS 8.0</b>	27440104
<b>ECLASS 8.1</b>	27440104
<b>ECLASS 9.0</b>	27440102
<b>ECLASS 10.0</b>	27440102
<b>ECLASS 11.0</b>	27440102
<b>ECLASS 12.0</b>	27272792
<b>ETIM 5.0</b>	EC002635
<b>ETIM 6.0</b>	EC002635
<b>ETIM 7.0</b>	EC002635
<b>ETIM 8.0</b>	EC002635
<b>UNSPSC 16.0901</b>	39121421

Pin assignment

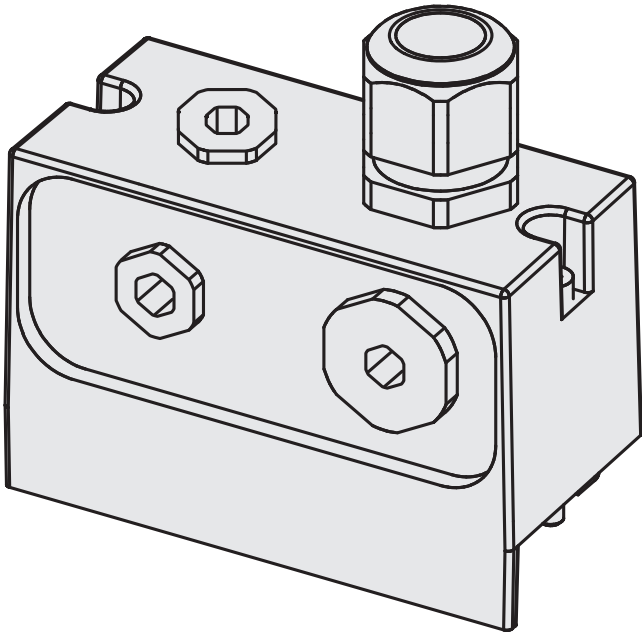

## SICK AT A GLANCE

SICK is one of the leading manufacturers of intelligent sensors and sensor solutions for industrial applications. A unique range of products and services creates the perfect basis for controlling processes securely and efficiently, protecting individuals from accidents and preventing damage to the environment.

We have extensive experience in a wide range of industries and understand their processes and requirements. With intelligent sensors, we can deliver exactly what our customers need. In application centers in Europe, Asia and North America, system solutions are tested and optimized in accordance with customer specifications. All this makes us a reliable supplier and development partner.

Comprehensive services complete our offering: SICK LifeTime Services provide support throughout the machine life cycle and ensure safety and productivity.

For us, that is “Sensor Intelligence.”

## WORLDWIDE PRESENCE:

Contacts and other locations –[www.sick.com](http://www.sick.com)