

DE1 variable speed starters
DS7 and **S801+/S811+** soft starters

DC1, DA1, DG1 and **SVX/SPX** variable frequency drives
Rapid Link 4.0 distributed, electronic drive system

Product Range Catalog

Efficient Engineering for
Starting and Controlling Motors

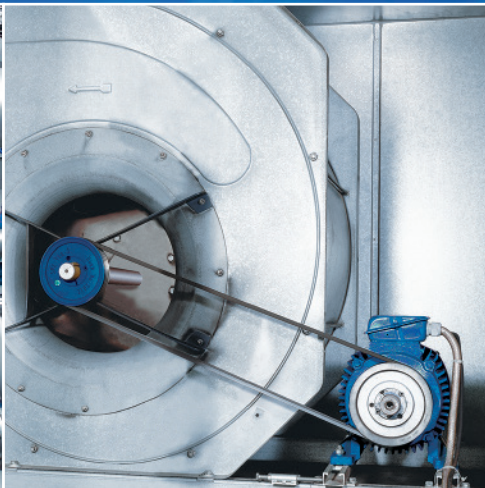

EATON

Powering Business Worldwide

Eaton Online Catalog – find product details quickly and efficiently!

You can find comprehensive up-to-date product information at <http://ecat.moeller.net>

Lookup

You can search by keywords, product names, article numbers, technical data: The search understands everything and takes you straight to the product you're looking for.

Graphical navigation

Graphical representation of the fields of application and product groups.

Selection aids

Tailored to the typical expert's approach, this search aid helps you quickly find the product you need.

Data sheets

For every article the catalog can generate a technical data sheet, which you can convert to a PDF file for printing or saving with a single click.

Parts lists

From your search results you can create a parts list that you can then send to your Eaton sales partner as a query.

You can find comprehensive up-to-date information about Eaton's automation products and switchgear in our Online Catalog.



HTML data sheet; can be saved as PDF file.



Parts list, e.g. for queries to Eaton Sales.



Contents

Technical overview

Page 4

PowerXL™ variable frequency drives



DE1 variable speed starter
Drives Economy (VSS) Page 6

DC1 variable frequency drive
Drives Compact Page 14

DA1 variable frequency drives
Drives Advanced Page 28

DG1 variable frequency drives
Drives General Purpose Page 42

Accessories and Engineering
(reactor, sine filter, braking resistance) Page 52

Variable frequency drive 9000X



SVX/SPX variable frequency drives
(Standard-/variable frequency drives) Page 74

Soft starters



DS7 soft starters
(two-phase controlled) Page 96

Soft starter S801+/S811+
(three-phase controlled) Page 116

Rapid Link



Rapid Link 4.0 distributed, electronic drive
system Page 126

SmartWire-DT™

SWD communication system
(accessories) Page 144

Appendix

Motor data, motor information
(General Information, service) Page 150



Energizing a world that demands more.

Discover today's Eaton.

Powering business worldwide

As a global diversified power management company, we help customers worldwide manage the power needed for buildings, aircraft, trucks, cars, machinery and businesses.

Eaton's innovative technologies help customers manage electrical, hydraulic and mechanical power more reliably, efficiently, safely and sustainably.



Powering Business Worldwide



We deliver:

- **Electrical solutions** that use less energy, improve power reliability and make the places we live and work safer and more comfortable
- **Hydraulic and electrical solutions** that enable machines to deliver more productivity without wasting power
- **Aerospace solutions** that make aircraft lighter, safer and less costly to operate, and help airports operate more efficiently
- **Vehicle drivetrain and powertrain solutions** that deliver more power to cars, trucks and buses, while reducing fuel consumption and emissions

We provide integrated solutions that help make energy, in all its forms, more practical and accessible.

With 2012 sales of \$16.3 billion, Eaton has approximately 103,000 employees around the world and sells products in more than 175 countries.



Eaton's electrical business

Eaton is a global leader with expertise in:

- Power distribution and circuit protection
- Backup power protection
- Solutions for harsh and hazardous environments
- Lighting and security
- Structural solutions and wiring devices
- Control and automation
- Engineering services

Eaton is positioned through its global solutions to answer today's most critical electrical power management challenges. With 100 years of electrical experience behind us, we're energized by the challenge of powering up a world that demands twice as much energy as today. We're anticipating needs, engineering products, and creating solutions to energize our markets today and in the future.

We are dedicated to ensuring that reliable, efficient and safe power is available when it's needed most.

www.eaton.eu

			PowerXL	
			DE1	DC1
Mains voltage (50/60Hz)				
$U_e = 115$ V AC, single-phase	U_{LN}	V	-	110 (-10%) - 115 (+10%)
$U_e = 230$ V AC, 1-phase	U_{LN}	V	200 (-10%) - 240 (+10%)	200 (-10%) - 240 (+10%)
$U_e = 230$ V AC, 3-phase	U_{LN}	V	-	200 (-10%) - 240 (+10%)
$U_e = 400$ V AC, 3-phase	U_{LN}	V	380 (-10%) - 480 (+10%)	380 (-10%) - 480 (+10%)
$U_e = 500$ V AC, 3-phase	U_{LN}	V	-	-
$U_e = 600$ V AC, 3-phase	U_{LN}	V	-	-
Rated operational current				
$U_2 = 115$ V AC, single-phase	I_e	A	-	7 - 10,5
$U_2 = 230$ V AC, single-phase	I_e	A	-	4,3 - 10,5
$U_2 = 230$ V AC, 3-phase	I_e	A	1,3 - 9,6	2,3 - 18
$U_2 = 400$ V AC, 3-phase	I_e	A	1,3 - 16	2,2 - 24
$U_2 = 500$ V AC, 3-phase	I_e	A	-	-
$U_2 = 600$ V AC, 3-phase	I_e	A	-	-
Overload current at I_L (low overload)/Overload current at I_H (High overload)	I_L/I_H	%	-/150	-/150
Overload cycle for 60 s every 600 s				
max. starting current (High Overload)				
for 2 seconds every 20 seconds		%	-	175
for 1.875 seconds every 600 seconds		%	200	-
for 4 seconds every 40 seconds		%	-	-
Operation Mode				
U/f control			✓	✓
Speed control with slip compensation			✓	✓
sensorless vector control (SLV)			-	-
optional: Vector control with feedback (CLV)			-	-
CT = Constant torque /VT = Variable torque			✓/-	✓/-
Assigned motor rating				
at 115 V, 50 Hz	P	kW	-	0,37 - 0,55
at 230 V, 50 Hz	P	kW	0,25 - 2,2	0,37 - 11
at 400 V, 50 Hz	P	kW	0,37 - 7,5	0,75 - 11
at 500 V, 50 Hz	P	kW	-	-
at 690 V, 50 Hz	P	kW	-	-
Output Frequency	f_2	Hz	0 - 50/60 (max. 300)	0 - 50/60 (max. 500)
Switching frequency	f_{PWM}	kHz	adjustable 4 - 32 (audible)	adjustable 4 - 32 (audible)
Degree of Protection			IP20/NEMA 0	IP20/NEMA 0, IP66/NEMA4X
Ambient temperature at I_L/I_H (operation)				
IP00	θ	°C	-	-
IP20/IP21	θ	°C	-10 - +50 (max. +60)	-10 - +50
IP54/IP55	θ	°C	-	-
IP66	θ	°C	-	-10 - +40
Fitted with				
Radio interference suppression filter			-/✓	-/✓
Brake chopper			-	-/✓
DC link choke			-	-
Additional PCB protection (coated board)			-	-
7-digit display assembly			-	✓
OLED display			-	-
Multi-line graphic display			-	-
Safety function STO (Safe Torque Off, SIL1, PLc Cat 1)			-	-
Interface/field bus (built-in)				
OP-Bus (RS485)/Modbus RTU			✓	-
OP-Bus (RS485)/Modbus RTU, CANopen®			-/✓(DE11)	✓
Modbus RTU, Modbus TCP, BACnet MS/TP, Ethernet IP			-	-
Fieldbus connection (optional)				
			-	-
Connection to SmartWire-DT				
			optional	optional
Analog inputs			1 (0 - 10 V, 0/4 - 20 mA)	1/2 (0 - 10 V, 0/4 - 20 mA)
Analog outputs			-	-
Digital inputs (24 V)			3/4	3/4
Digital outputs (24 V)			-	-/1
Relay outputs			1 (N/O)	1 (N/O)
Standards			IEC/EN 61800-2, IEC/EN 61800-3, IEC/EN 61800-5	
Certifications			CE, UL, cUL, RCM	CE, UL, cUL, RCM, UkrSEPRO, EAC
Approvals			-	-
Production quality			RoHS, ISO 9001	

DA1	DL1	DG1	9000X SVX	SPX
-	-	-	-	-
200 (-10%) - 240 (+10%)	-	-	-	-
200 (-10%) - 240 (+10%)	-	208 (-15%) - 240 (+10%)	-	-
380 (-10%) - 480 (+10%)	380 (-10%) - 480 (+10%)	380 (-15%) - 500 (+10%)	380 (-15%) - 500 (+10%)	380 (-15%) - 500 (+10%)
500 (-10%) - 600 (+10%)	-	-	-	-
-	-	-	525 (-15%) - 690 (±10%)	525 (-15%) - 690 (±10%)
-	-	-	-	-
-	-	-	-	-
4,3 - 248	-	3,7 - 312	-	-
2,2 - 450	9,5 - 72	2,2 - 310	2,2 - 245	2,2 - 1940
2,1 - 150	-	-	-	-
-	-	-	3,2 - 170	3,2 - 1900
-/150	-/150	110/150	110/150	110/150
-	-	200	-	-
-	-	-	-	-
200	200	-	-	-
✓	✓	✓	✓	✓
✓	✓	✓	-	-
✓	✓	✓	✓	✓
✓	✓	✓	-	✓
✓/✓	✓/✓	✓ I _H /✓ bei I _L	✓ I _H /✓ bei I _L	✓ I _H /✓ bei I _L
-	-	-	-	-
0,75 - 75	-	0,75 - 75	-	-
0,75 - 250	4 - 37	0,75 - 160	0,75 - 132	0,75 - 900
1,1 - 90	-	-	-	-
-	-	-	2,2 - 160	2,2 - 1800
0 - 50/60 (max. 500)	0 - 50/60 (max. 500)	0 - 50/60 (max. 400)	0 - 50/60 (max. 320)	0 - 50/60 (max. 320)
adjustable 4 - 32 (audible)	adjustable 4 - 32 (audible)	4	adjustable 1 - 16	adjustable 1 - 16
IP20/NEMA 0, IP55, IP55/NEMA 3, IP66/NEMA4X	IP20/NEMA 0, IP55/NEMA 3	IP21/NEMA1, IP54	IP21, IP54	IP00, IP21, IP54
-	-	-	-	-10 - +40
-10 - +50	-10 - +50	-30 - +50	-10 - +40/-10 - +50	-10 - +40/-10 - +50
-10 - +40	-10 - +40	-30 - +50	-10 - +40/-10 - +50	-10 - +40/-10 - +50
-10 - +40	-	-	-	-
✓	✓	✓	✓	✓
-/✓	✓	✓	-/✓	-/✓
✓ (FS5 - FS7)	✓ (FS 5 - FS7)	✓	-/✓	-/✓
✓	-/✓	✓	-/Option	-/Option
✓	✓	-	-	-
✓	-	-	✓	✓
-	-	✓	-	-
✓	✓	✓	-	-
-	-	-	-	-
✓	✓	✓	-	-
-	-	✓	-	-
Ethernet IP, DeviceNet, PROFIBUS, PROFINET, Modbus-TCP, EtherCAT, SmartWire-DT		PROFIBUS, CANopen®, DeviceNet	PROFIBUS-DP, LonWorks, CANopen®, DeviceNet, Modbus-TCP, BACnet/IP	
optional	optional	-	-	-
1/2 (-10 - +10 V, 0/4 - 20 mA)	1/2 (0 - 10 V, 0/4 - 20 mA)	2 (0 - 10 V, 0/4 - 20 mA)	2 (0 - 10 V, 0/4 - 20 mA)	2 (0 - 10 V, 0/4 - 20 mA)
1/2 (0 - 10 V, 0/4 - 20 mA)	1/2 (0 - 10 V, 0/4 - 20 mA)	2 (0 - 10 V, 0/4 - 20 mA)	1 (0/4 - 20 mA)	1 (0/4 - 20 mA)
4/5	4/5	8	6	6
1/2	1/2	1	1	1
2 (1x N/O, 1x change over contact)	2 (1x N/O, 1x change over contact)	3 (2x N/O, 1x change over contact)	2 (N/O)	2 (N/O)
IEC/EN 61800-2, IEC/EN 61800-3, IEC/EN 61800-5				
CE, UL, cUL, RCM, UkrSEPRO, EAC			CE, UL, cUL, RCM	CE, UL, cUL, RCM
-	-	-	DNV	DNV
RoHS, ISO 9001				



PowerXL DE1 Variable Speed Starters

The new PowerXL DE1 variable speed starter combines ease of use and maximum reliability with variable motor speeds and improved machine energy efficiency. This new category of devices is the first to close the gap between conventional motor starters and variable frequency drives and combine all the advantages in a single unit.

Performance range:

- 0.25 ... 2.2 kW (U_g : 1~ 230 V, U_2 : 3~ 230 V)
- 0.37 ... 7.5 kW (U_g : 3~ 400 V, U_2 : 3~ 400 V)

Features:

- Compact: 45-mm width
- Out-of-the-box commissioning without parameterization
- No special drives engineering skills or knowledge required
- Screwdriver parameterization can be set with an optional configuration module (DXE-EXT-SET)
- Trip-free-design ensures maximum machine availability
- Suitable for use in ambient temperatures of up to 60 °C
- International standards (CE, UL, cUL, cTick, RoHS)

Accessories:

- Plug-in configuration module
- SmartWire-DT connection
- External LED keypad
- Mains chokes
- Motor chokes
- Sine filters
- drivesConnect parameter configuration software
- Parameter Copy Stick
- External EMC filter

Applications:

- Fans, pumps
- Simple Machines
- Retrofits in machines and systems in order to replace conventional motor starters or contactors for motor control



System overview	8
Key to type references	9
Sizes and degree of protection	9
UL/CSA	9
Ordering	
Variable speed starter DE1	10
Variable speed starter DE11	11
Accessories	12

8 PowerXL variable speed starter

System overview

DE1, frame size 1

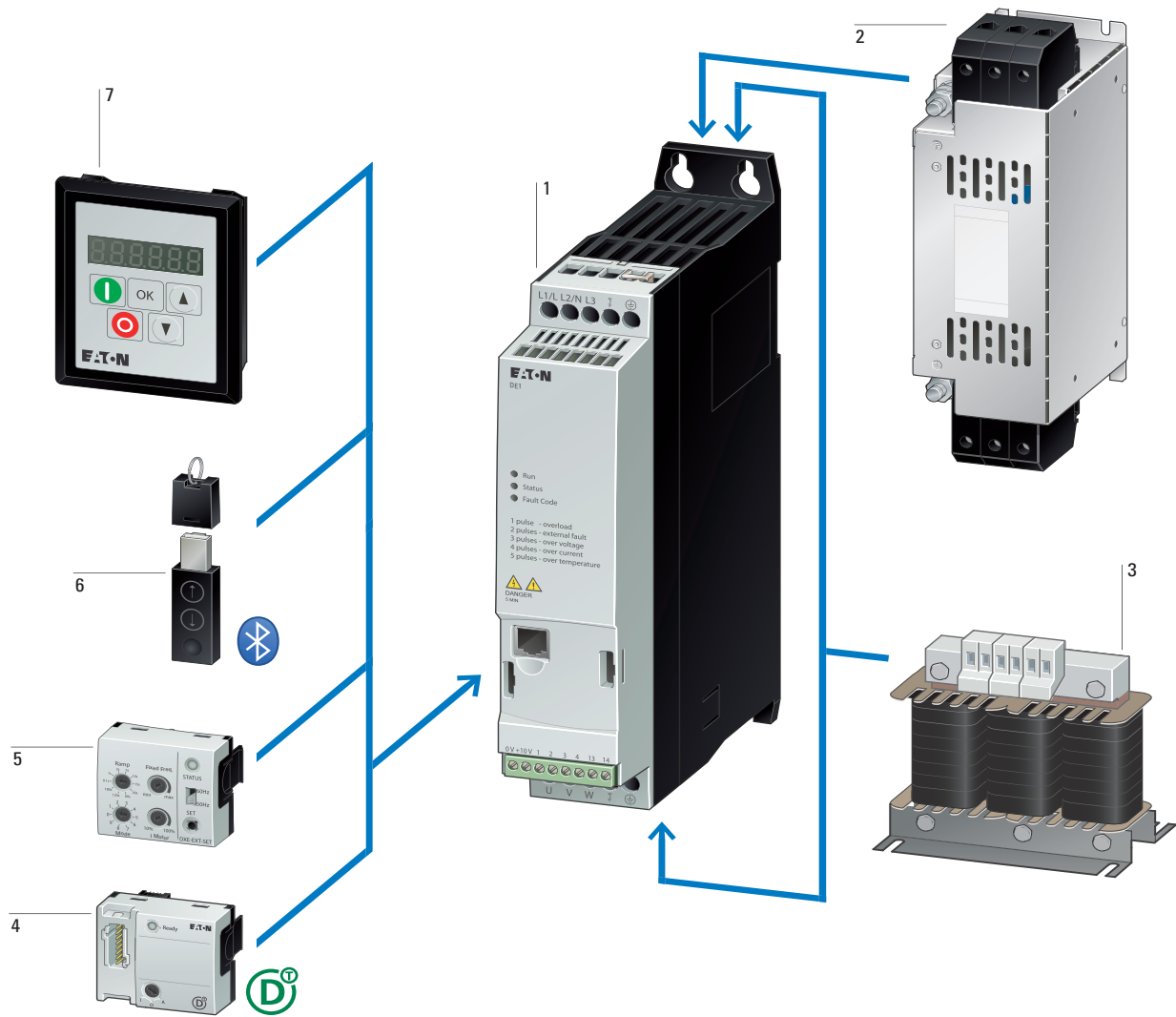

DE1 variable speed starter 1

→ page 10

External radio interference suppression filter 2

→ page 54

Mains choke, motor choke 3

→ page 60

SmartWire-DT module 4

→ page 12

Configuration module 5

→ page 12

Memory and Bluetooth communication stick 6

→ page 12

External keypad 7

→ page 12

Key to type references

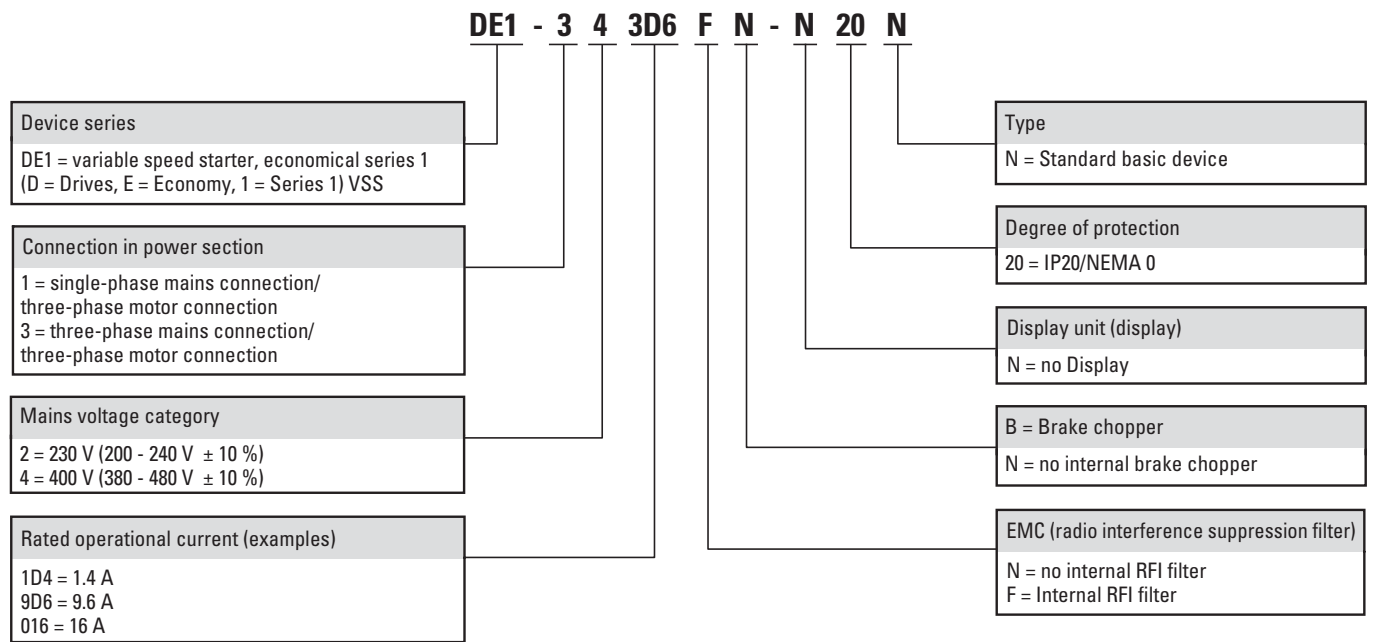

Sizes and degree of protection

Frame size	Degree of Protection IP20/NEMA 0
------------	-------------------------------------

FS1

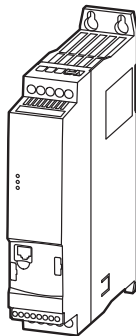

FS2

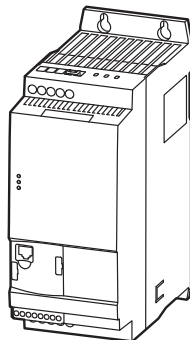











UL/CSA

Information relevant for export to North America



Product Standards	UL 508C; CSA-C22.2 No. 14; IEC/EN61800-3; IEC/EN61800-5; CE marking
UL File No.	E172143
UL Category Control No.	NMMS, NMMS7
CSA File No.	UL report applies to both US and Canada
North America Certification	UL listed, certified by UL for use in Canada
Suitable for	Branch circuits
Max. Voltage Rating	1~ 240 V AC IEC: TN-S UL/CSA: "Y" (Solidly Grounded Wey) 3~ 480 V AC IEC: TN-S UL/CSA: "Y" (Solidly Grounded Wey)
Degree of Protection	IEC: IP20

Rated operational current ^{1), 2)}	Assigned motor rating ^{2), 3), 4)}		Radio interference suppression filter	Frame size	Degree of Protection	Part no. Article no.	Price see price list	Std. pack		
	P kW	P HP								
Variable speed starter										
U _e 230 V AC, 1-phase / U ₂ 230 V AC, 3-phase Mains voltage (50/60Hz) U _{LN} 200 (-10%) - 240 (+10%) V										
1.4	0.25	0.33	- ✓	FS1	IP20/NEMA 0	DE1-121D4NN-N20N 177359	1 off  			
						DE1-121D4FN-N20N 174327				
2.3	0.37	0.5	- ✓			DE1-122D3NN-N20N 177360				
						DE1-122D3FN-N20N 174328				
2.7	0.55		- ✓			DE1-122D7NN-N20N 177361				
						DE1-122D7FN-N20N 174329				
4.3	0.75	1	- ✓	FS2	IP20/NEMA 0	DE1-124D3NN-N20N 177362			1 off  	
						DE1-124D3FN-N20N 174330				
7	1.5	2	- ✓			DE1-127D0NN-N20N 177363				
						DE1-127D0FN-N20N 174331				
9.6	2.2	3	- ✓			DE1-129D6NN-N20N 177364				
						DE1-129D6FN-N20N 174332				
U _e 400 V AC, 3-phase / U ₂ 400 V AC, 3-phase Mains voltage (50/60Hz) U _{LN} 380 (-10%) - 480 (+10%) V										
1.3	0.37	0.5	- ✓	FS1	IP20/NEMA 0	DE1-341D3NN-N20N 177365	1 off  			
						DE1-341D3FN-N20N 174333				
2.1	0.75	1	- ✓			DE1-342D1NN-N20N 177366				
						DE1-342D1FN-N20N 174334				
3.6	1.5	2	- ✓			DE1-343D6NN-N20N 177367				
						DE1-343D6FN-N20N 174335				
5	2.2	3	- ✓	FS2	IP20/NEMA 0	DE1-345D0NN-N20N 177368			1 off  	
						DE1-345D0FN-N20N 174336				
6.6	3		- ✓			DE1-346D6NN-N20N 177369				
						DE1-346D6FN-N20N 174337				
8.5	4	5	- ✓			DE1-348D5NN-N20N 177370				
						DE1-348D5FN-N20N 174338				
11.3	5.5	7.5	- ✓	FS2	IP20/NEMA 0	DE1-34011NN-N20N 177371	1 off  			
						DE1-34011FN-N20N 174339				
16	7.5	10	- ✓			DE1-34016NN-N20N 177372				
						DE1-34016FN-N20N 174340				

Notes

¹⁾ Rated operational current at an operating frequency of 16 kHz and an ambient air temperature of +50 °C

²⁾ Overload cycle: 150 % for 60 s every 600 s





³⁾ DE1-12...: at 230 V, 50 Hz/at 220 - 240 V, 60 Hz

DE1-34...: at 400 V, 50 Hz/at 440 - 480 V, 60 Hz

⁴⁾ for normal internally and externally ventilated 4 pole, three-phase asynchronous motors with 1500 rpm⁻¹ at 50 Hz or 1800 min⁻¹ at 60 Hz



Information relevant for export to North America → Page 9

Rated operational current ^{1), 2)} I_e A	Assigned motor rating ^{2), 3), 4)}		Radio interference suppression filter	Frame size	Degree of Protection	Part no. Article no.	Price see price list	Std. pack
	P kW	P HP						
PowerXL variable speed starter DE11								
U _e 230 V AC, 1-phase / U ₂ 230 V AC, 3-phase Mains voltage (50/60Hz) U _{LN} 200 (-10%) - 240 (+10%) V								
1.4	0.25	0.33	- ✓	FS1	IP20/NEMA 0	DE11-121D4NN-N20N 180656		1 off  
						DE11-121D4FN-N20N 180650		
2.3	0.37	0.5	- ✓			DE11-122D3NN-N20N 180657		
						DE11-122D3FN-N20N 180651		
2.7	0.55		- ✓			DE11-122D7NN-N20N 180658		
						DE11-122D7FN-N20N 180652		
4.3	0.75	1	- ✓	FS2	IP20/NEMA 0	DE11-124D3NN-N20N 180659		
						DE11-124D3FN-N20N 180653		
7	1.5	2	- ✓			DE11-127D0NN-N20N 180660		
						DE11-127D0FN-N20N 180654		
9.6	2.2	3	- ✓			DE11-129D6NN-N20N 180661		
						DE11-129D6FN-N20N 180655		
U _e 400 V AC, 3-phase / U ₂ 400 V AC, 3-phase Mains voltage (50/60Hz) U _{LN} 380 (-10%) - 480 (+10%) V								
1.3	0.37	0.5	- ✓	FS1	IP20/NEMA 0	DE11-341D3NN-N20N 180670		1 off  
						DE11-341D3FN-N20N 180662		
2.1	0.75	1	- ✓			DE11-342D1NN-N20N 180671		
						DE11-342D1FN-N20N 180663		
3.6	1.5	2	- ✓			DE11-343D6NN-N20N 180672		
						DE11-343D6FN-N20N 180664		
5	2.2	3	- ✓	FS2	IP20/NEMA 0	DE11-345D0NN-N20N 180673		
						DE11-345D0FN-N20N 180665		
6.6	3		- ✓			DE11-346D6NN-N20N 180674		
						DE11-346D6FN-N20N 180666		
8.5	4	5	- ✓			DE11-348D5NN-N20N 180675		
						DE11-348D5FN-N20N 180667		
11.3	5.5	7.5	- ✓	FS2	IP20/NEMA 0	DE11-34011NN-N20N 180676		
						DE11-34011FN-N20N 180668		
16	7.5	10	- ✓			DE11-34016NN-N20N 180677		
						DE11-34016FN-N20N 180669		

Notes



¹⁾ Rated operational current at an operating frequency of 16 kHz and an ambient air temperature of +50 °C









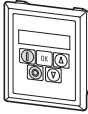

²⁾ Overload cycle: 150 % for 60 s every 600 s

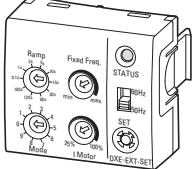
³⁾ DE11-12...: at 230 V, 50 Hz/bei 220 - 240 V, 60 Hz

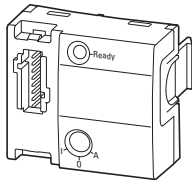
DE11-34...: at 400 V, 50 Hz/at 440 - 480 V, 60 Hz

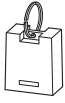
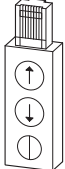

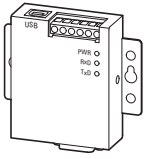
⁴⁾ for normal internally and externally ventilated 4 pole, three-phase asynchronous motors with 1500 rpm⁻¹ at 50 Hz or 1800 min⁻¹ at 60 Hz

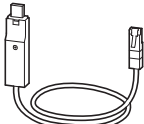
  Information relevant for export to North America → Page 9

Description	Length	For use with	Part no. Article no.	Price see price list	Std. pack
External keypad					
 With 7-digit display assembly Front IP54 With approx. 3 m-long, plug-in connection cable (RJ45, 8-pin)	3	DE1, DE11, DC1, DA1	DX-KEY-LED2 186946		1 off  
Configuration module					
Plug-in module (front)  With selector switch for ramp time and operating mode With potentiometer for motor protection and fixed frequency	-	DE1, DE11	DXE-EXT-SET 174621		1 off  
Fieldbus modules					
Plug-in module (front) -	2 x RJ45, 8 pole	DE1, DC1	DX-NET-ETHERNET2-2 184969		1 off
SmartWire-DT Modules					
 Plug-in module (front) with slot for SWD4-8SF2-5 external device plug	-	DE1, DE11, DC1 (IP20)	DX-NET-SWD3 169131		1 off  
PC communication					
Parameter storage unit and Bluetooth communication stick   For storage, copying parameters, and/or transferring parameters to a PC with the drivesConnect software via Bluetooth With 2 function keys for uploading and downloading parameters with configuration memory	-	-	DX-COM-STICK2 186947		1 off  
Interface converter For directly connecting the variable-frequency drive to a computer with drivesConnect software  Interface converter USB/RS485 with connection cable, electrically isolated 1 x SUB-D plug, 9-pole Terminal strip, 5-terminal Status-LED	-	DE1, DE11, DC1, DA1	DX-COM-PCKIT 169135		1 off  
 Interface converter USB/RS485 with connection cable, electrically isolated	3	DE1, DE11, DC1, DA1	DX-CBL-PC-3M0 744-A3036-00P		1 off

  **Information relevant for export to North America**

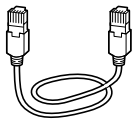
Product Standards	UL 508C; CSA-C22.2 No. 14; IEC/EN61800-3; IEC/EN61800-5; CE marking DXE-EXT-SET: UL 508C; CSA-C22.2 No. 274; IEC/EN61800-3; IEC/EN61800-5; CE marking
UL File No.	E172143
UL Category Control No.	NMMS, NMMS7
CSA File No.	UL report applies to both US and Canada
North America Certification	UL listed, certified by UL for use in Canada
Suitable for	Branch circuits

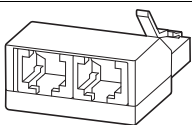
Description	Length	For use with	Part no. Article no.	Price see price list	Std. pack
PC communication					
connection cable					
	Patch cord with RJ45 plugs, 8 pole	0.5	DE1, DE11, DC1, DA1	DX-CBL-RJ45-0M5 169137	1 off  
		1		DX-CBL-RJ45-1M0 169138	
		3		DX-CBL-RJ45-3M0 169139	
Splitter					
	RJ45, 8-pin, 2 sockets/1 plug for CANopen® and Modbus RTU	-	DE1, DE11, DC1 (IP20), DA1 (IP20)	DX-SPL-RJ45 179313	1 off
	RJ45, 8 pole, 1 socket/1 plug for CANopen® and Modbus RTU With 2 resistors, 120 Ω	-	DE1, DE11, DC1 (IP20), DA1 (IP20)	DX-SPL-RJ45-TERM 179314	1 off

  **Information relevant for export to North America**

Product Standards	UL 508C; CSA-C22.2 No. 14; IEC/EN61800-3; IEC/EN61800-5; CE marking DXE-EXT-SET: UL 508C; CSA-C22.2 No. 274; IEC/EN61800-3; IEC/EN61800-5; CE marking
UL File No.	E172143
UL Category Control No.	NMMS, NMMS7
CSA File No.	UL report applies to both US and Canada
North America Certification	UL listed, certified by UL for use in Canada
Suitable for	Branch circuits



PowerXL Variable Frequency Drives DC1 Compact Machinery Drive

The compact PowerXL DC1 variable frequency drive is particularly well-suited for use with simple pump, fan, and conveyor belt systems. It can be quickly and easily configured and commissioned, resulting in tangible savings.

Performance range:

- 0.37 ... 0.55 kW (U_0 : 1~ 115 V, U_2 : 1~ 115 V)
- 0.37 ... 1.1 kW (U_0 : 1~ 115 V, U_2 : 3~ 230 V)
- 0.37 ... 1.1 kW (U_0 : 1~ 230 V, U_2 : 1~ 230 V)
- 0.37 ... 4 kW (U_0 : 1~ 230 V, U_2 : 3~ 230 V)
- 0.37 ... 11 kW (U_0 : 3~ 230 V, U_2 : 3~ 230 V)
- 0.75 ... 22 kW (U_0 : 3~ 400 V, U_2 : 3~ 400 V)

Features:

- Fast commissioning with 14 basic parameters
- Large overload capability: 150% for 60 seconds, 175% for 2 seconds
- Ambient air temperature up to 50 °C without derating
- Sensorless Vector Control
- Control of high efficient IE4 motors
- Full Short Circuit Protection
- Integrated CANopen and Modbus RTU
- Degrees of protection IP20 and IP66
- Integrated EMC filter
- Integrated braking transistor
- Integrated PI controller
- V/F control
- Voltage boost
- DC braking
- Detachable control signal terminal strip
- International standards (CE, UL, cUL, RCM, RoHS, EAC, UkrSEPRO)

Accessories:

- SmartWire-DT connection
- I/O expansions
- External keypad
- Mains chokes
- Motor chokes
- Sine filters
- Braking resistances
- drivesConnect parameter configuration software
- External EMC filter

Applications:

- Pumps, fans
- Machines
- Coating systems
- Conveyor belts
- Filling machines
- Distributed applications (IP66)
- Single-phase motors



System overview	16
Key to type references	17
Sizes and degree of protection	17
UL/CSA	17
Ordering	
Variable frequency drives DC1, IP20	18
Variable frequency drives DC1, IP66	22
Accessories	26

System overview

DC1 with IP20 degree of protection

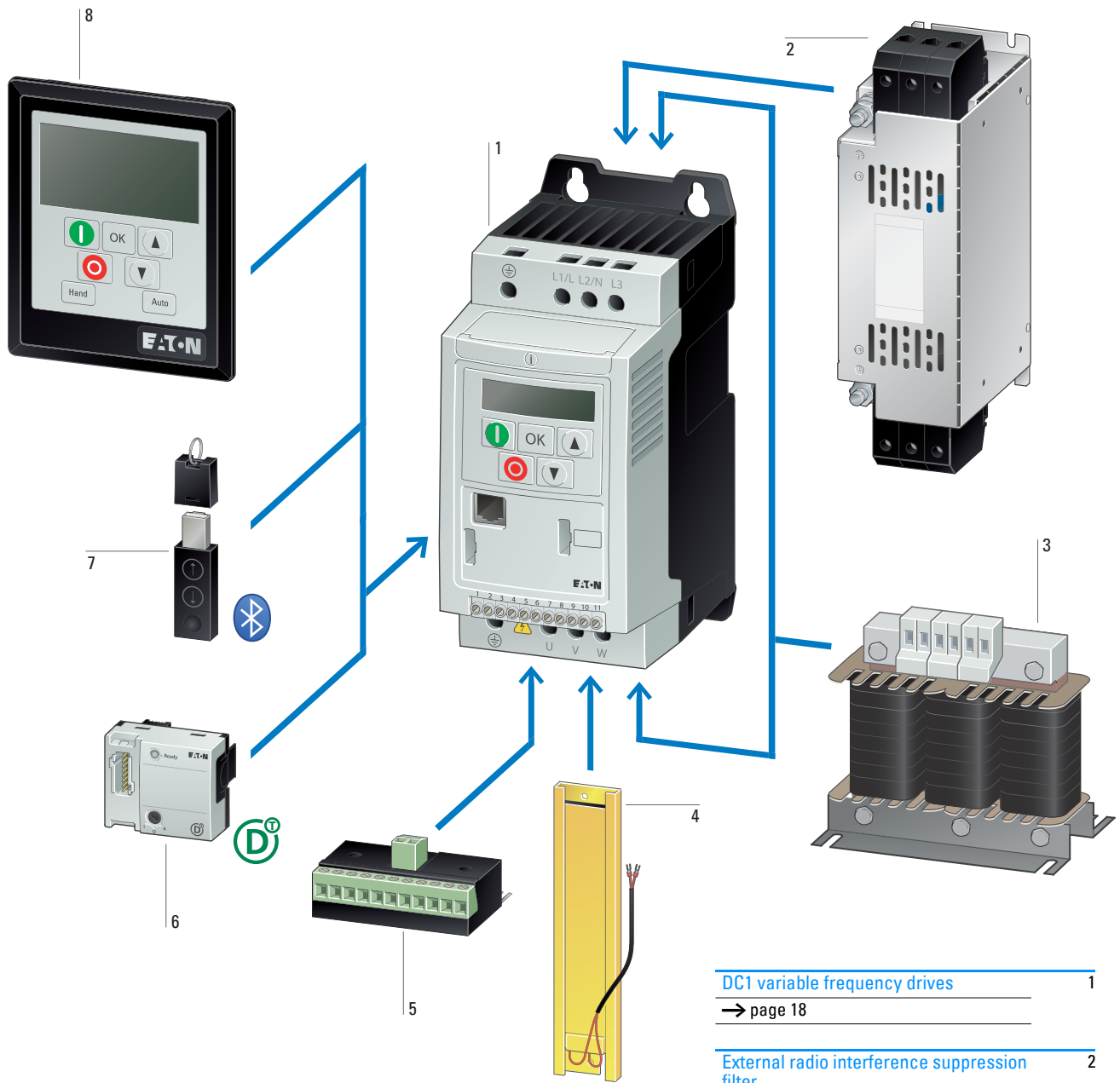

DC1 variable frequency drives	1
→ page 18	
External radio interference suppression filter	2
→ page 54	
Mains choke, motor choke, sine filter	3
→ page 60, → page 61	
Braking resistance	4
→ page 56	
Expansion modules	5
→ page 26	
SmartWire-DT module	6
→ page 26	
Memory and Bluetooth communication stick	7
→ page 26	
External keypad	8
→ page 26	

Key to type references

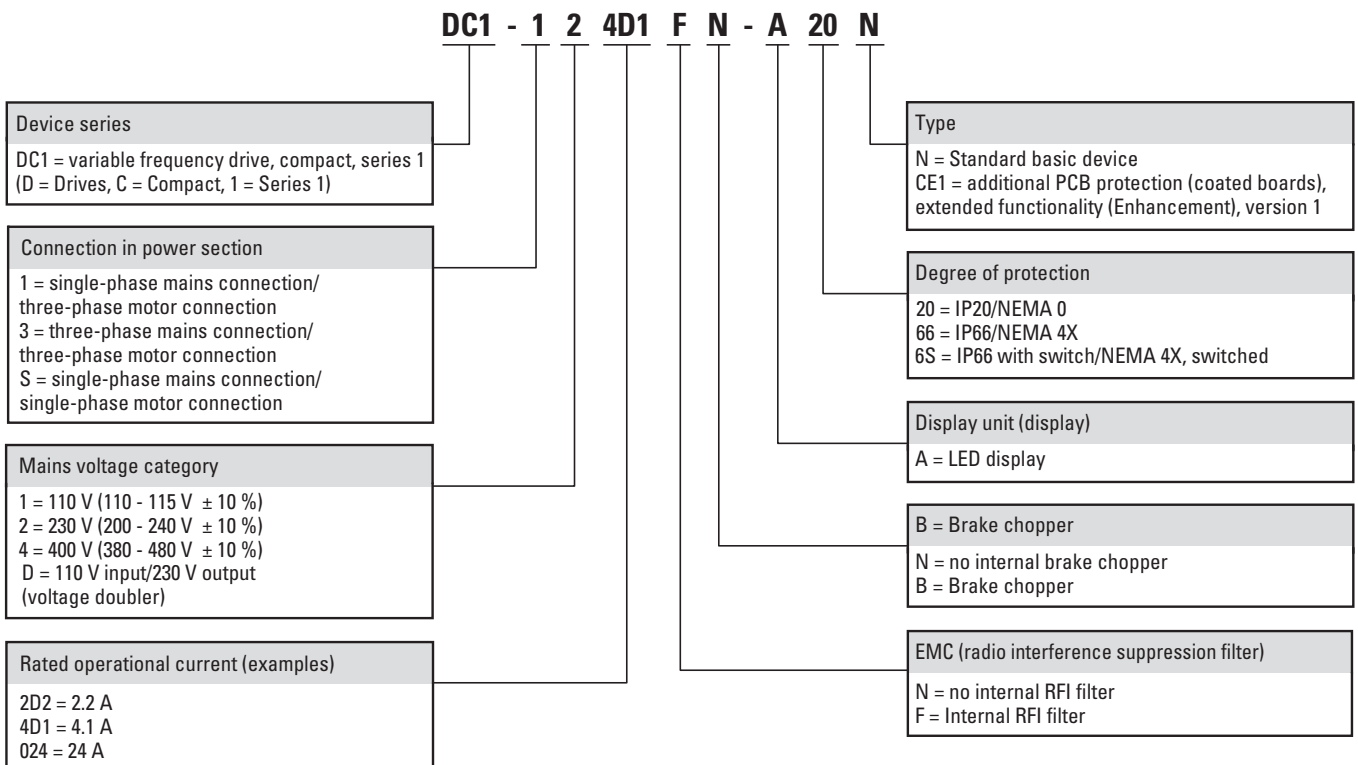

DC1

Sizes and degree of protection





Frame size	Degree of Protection		
	IP20/NEMA 0	IP66/NEMA 4X	IP66/NEMA 4X Local controls
FS1			
FS2			
FS3			
FS4			

UL/CSA

Information relevant for export to North America



Product Standards	UL 508C; CSA-C22.2 No. 14; IEC/EN61800-3; IEC/EN61800-5; CE marking
UL File No.	E172143
UL Category Control No.	NMMS, NMMS7
CSA File No.	UL report applies to both US and Canada
North America Certification	UL listed, certified by UL for use in Canada
Suitable for	Branch circuits
Max. Voltage Rating	1~ 120 V AC IEC: TN-S UL/CSA: "Y" (Solidly Grounded Wey) 1~ 240 V AC IEC: TN-S UL/CSA: "Y" (Solidly Grounded Wey) 3~ 240 V AC IEC: TN-S UL/CSA: "Y" (Solidly Grounded Wey) 3~ 480 V AC IEC: TN-S UL/CSA: "Y" (Solidly Grounded Wey)

Rated operational current ^{1), 4)}	Assigned motor rating ^{1), 2), 3)}		Fitted with	Frame size	Degree of Protection	Part no. Article no.	Price see price list	Std. pack
I_e A	P kW	P HP	Radio interference suppression filter Brake chopper 7-digital display assembly					
PowerXL variable frequency drives DC1								
U _e 115 V AC, single-phase / U ₂ 115 V AC, single-phase Mains voltage (50/60Hz) U _{LN} 110 (-10%) - 115 (+10%) V								
7	0.37	0.5	- - ✓	FS1	IP20/NEMA 0	DC1-S17D0NN-A20CE1 186073		1 off  
10.5	0.55	0.75	- ✓ ✓	FS2		DC1-S1011NB-A20CE1 186076		
U _e 230 V AC, 1-phase / U ₂ 230 V AC, single-phase Mains voltage (50/60Hz) U _{LN} 200 (-10%) - 240 (+10%) V								
4.3	0.37	0.5	- - ✓ ✓ - ✓	FS1	IP20/NEMA 0	DC1-S24D3NN-A20CE1 186079		1 off  
7	0.75	1	- - ✓ ✓ - ✓			DC1-S24D3FN-A20CE1 186088		
						DC1-S27D0NN-A20CE1 186082		
						DC1-S27D0FN-A20CE1 186091		
10.5	1.1	1.5	- ✓ ✓ ✓ ✓ ✓	FS2		DC1-S2011NB-A20CE1 186085		
						DC1-S2011FB-A20CE1 186094		

Notes

¹⁾ Overload cycle: 150 % for 60 s every 600 s

²⁾ DC1-S1...: at 115 V, 50 Hz/at 110 - 120 V, 60 Hz

DE1-34...:DC1-S2...: at 230 V, 50 Hz/at 220 - 240 V, 60 Hz

³⁾ For AC motors with internal and external ventilation with 50/60 Hz without additional start capacitor

⁴⁾ Rated operational current at an operating frequency of 16 kHz and an ambient air temperature of +50 °C



Information relevant for export to North America → Page 17



Rated operational current ^{1), 4)} I _e A	Assigned motor rating ^{1), 2), 3)} P kW		Fitted with Radio interference suppression filter Brake chopper 7-digital display assembly	Frame size	Degree of Protection	Part no. Article no.	Price see price list	Std. pack
	P	HP						

PowerXL variable frequency drives DC1

The mains voltage of 115 V is raised to 230 V (output voltage) through an internal voltage double connection.



U_e 115 V AC, single-phase / U₂ 230 V AC, 3-phase

Mains voltage (50/60Hz) U_{LN} 110 (-10%) - 115 (+10%) V

2.3	0.37	0.5	- - ✓	FS1	IP20/NEMA 0	DC1-1D2D3NN-A20CE1 185765	1 off  
4.3	0.75	1	- - ✓			DC1-1D4D3NN-A20CE1 185768	
5.8	1.1	1.5	- ✓ ✓	FS2		DC1-1D5D8NB-A20CE1 185771	

U_e 230 V AC, 1-phase / U₂ 230 V AC, 3-phase

Mains voltage (50/60Hz) U_{LN} 200 (-10%) - 240 (+10%) V

2.3	0.37	0.5	- - ✓ ✓ - ✓	FS1	IP20/NEMA 0	DC1-122D3NN-A20CE1 185785	1 off  
4.3	0.75	1	- - ✓ ✓ - ✓			DC1-122D3FN-A20CE1 185803	
7	1.5	2	- - ✓ ✓ - ✓			DC1-124D3NN-A20CE1 185788	
			- - ✓ ✓ - ✓			DC1-124D3FN-A20CE1 185806	
			- ✓ ✓ ✓ ✓ ✓	FS2		DC1-127D0NN-A20CE1 185791	
			- ✓ ✓ ✓ ✓ ✓			DC1-127D0FN-A20CE1 185809	
10.5	2.2	3	- ✓ ✓ ✓ ✓ ✓		DC1-127D0NB-A20CE1 185794		
			- ✓ ✓ ✓ ✓ ✓		DC1-127D0FB-A20CE1 185812		
15.3 ⁵⁾	4	5	- ✓ ✓	FS3	DC1-12011NB-A20CE1 185797		
			- ✓ ✓ ✓ ✓ ✓		DC1-12011FB-A20CE1 185815		
			- ✓ ✓		DC1-12015NB-A20CE1 185800		

Notes



¹⁾ Overload cycle: 150 % for 60 s every 600 s

²⁾ at 230 V, 50 Hz/at 220 - 240 V, 60 Hz

³⁾ for normal internally and externally ventilated 4 pole, three-phase asynchronous motors with 1500 rpm⁻¹ at 50 Hz or 1800 min⁻¹ at 60 Hz

⁴⁾ Rated operational current at an operating frequency of 16 kHz and an ambient air temperature of +50 °C

⁵⁾ Rated operational current at a switching frequency of 8 kHz and an ambient air temperature of +50 °C

  Information relevant for export to North America → Page 17

Rated operational current ^{1), 4)}		Assigned motor rating ^{1), 2), 3)}		Fitted with	Frame size	Degree of Protection	Part no. Article no.	Price see price list	Std. pack
I_e A	P kW	P HP	Radio interference suppression filter Brake chopper 7-digital display assembly						
PowerXL variable frequency drives DC1									
U ₀ 230 V AC, 3-phase / U ₂ 230 V AC, 3-phase Mains voltage (50/60Hz) U _{LN} 200 (-10%) - 240 (+10%) V									
2.3	0.37	0.5	- - ✓	FS1	IP20/NEMA 0		DC1-322D3NN-A20CE1 185818		1 off 
4.3	0.75	1	- - ✓						
7	1.5	2	- - ✓	FS2			DC1-324D3NN-A20CE1 185821		
			- ✓ ✓				DC1-327D0NN-A20CE1 185824		
			✓ ✓ ✓				DC1-327D0NB-A20CE1 185827		
10.5	2.2	3	- ✓ ✓	FS3			DC1-327D0FB-A20CE1 185836		
			✓ ✓ ✓				DC1-32011NB-A20CE1 185830		
18 ⁵⁾	4	5	- ✓ ✓	FS4			DC1-32011FB-A20CE1 185839		
			✓ ✓ ✓				DC1-32018NB-A20CE1 185833		
24	5.5	7.5	- ✓ ✓	FS3			DC1-32018FB-A20CE1 185842		
			✓ ✓ ✓		DC1-32024NB-A20CE1 185777				
30	7.5	10	- ✓ ✓	FS4	DC1-32024FB-A20CE1 185774				
			✓ ✓ ✓		DC1-32030NB-A20CE1 185778				
46	11	15	- ✓ ✓	FS4	DC1-32030FB-A20CE1 185775				
			✓ ✓ ✓		DC1-32046NB-A20CE1 185779				
							DC1-32046FB-A20CE1 185776		

Notes

- ¹⁾ Overload cycle: 150 % for 60 s every 600 s
- ²⁾ DC1-32...: at 230 V, 50 Hz/at 220 - 240 V, 60 Hz
DC1-34...: at 400 V, 50 Hz/at 440 - 480 V, 60 Hz
- ³⁾ for normal internally and externally ventilated 4 pole, three-phase asynchronous motors with 1500 rpm⁻¹ at 50 Hz or 1800 min⁻¹ at 60 Hz
- ⁴⁾ Rated operational current at an operating frequency of 16 kHz and an ambient air temperature of +50 °C

Rated operational current ^{1), 4)} I _e A	Assigned motor rating ^{1), 2), 3)} P kW	P HP	Fitted with Radio interference suppression filter Brake chopper 7-digital display assembly	Frame size	Degree of Protection	Part no. Article no.	Price see price list	Std. pack
PowerXL variable frequency drives DC1								
U ₀ 400 V AC, 3-phase / U ₂ 400 V AC, 3-phase Mains voltage (50/60Hz) U _{LN} 380 (-10%) - 480 (+10%) V								
2.2	0.75	1	- - ✓ ✓ - ✓	FS1	IP20/NEMA 0	DC1-342D2NN-A20CE1 185721		1 off 
							DC1-342D2FN-A20CE1 185743	
4.1	1.5	2	- - ✓ ✓ - ✓	FS2		DC1-344D1NN-A20CE1 185724		
							DC1-344D1FN-A20CE1 185746	
			- ✓ ✓ ✓ ✓ ✓			DC1-344D1NB-A20CE1 185727		
						DC1-344D1FB-A20CE1 185749		
5.8	2.2	3	- ✓ ✓ ✓ ✓ ✓			DC1-345D8NB-A20CE1 185730		
						DC1-345D8FB-A20CE1 185752		
9.5	4	5	- ✓ ✓ ✓ ✓ ✓			DC1-349D5NB-A20CE1 185733		
						DC1-349D5FB-A20CE1 185755		
14	5.5	10	- ✓ ✓ ✓ ✓ ✓	FS3		DC1-34014NB-A20CE1 185736		
							DC1-34014FB-A20CE1 185758	
18	7.5		- ✓ ✓ ✓ ✓ ✓			DC1-34018NB-A20CE1 185739		
						DC1-34018FB-A20CE1 185761		
24 ⁵⁾	11	15	- ✓ ✓ ✓ ✓ ✓		DC1-34024NB-A20CE1 185742			
					DC1-34024FB-A20CE1 185764			
30	15	20	- ✓ ✓ ✓ ✓ ✓	FS4	DC1-34030NB-A20CE1 185783			
						DC1-34030FB-A20CE1 185780		
39	18.5	25	- ✓ ✓ ✓ ✓ ✓		DC1-34039NB-A20CE1 185784			
					DC1-34039FB-A20CE1 185781			
46	22	30	- ✓ ✓ ✓ ✓ ✓		DC1-34046NB-A20CE1 185844			
					DC1-34046FB-A20CE1 185782			

Notes

- ¹⁾ Overload cycle: 150 % for 60 s every 600 s
- ²⁾ DC1-34...: at 400 V, 50 Hz/at 440 - 480 V, 60 Hz
- ³⁾ for normal internally and externally ventilated 4 pole, three-phase asynchronous motors with 1500 rpm⁻¹ at 50 Hz or 1800 min⁻¹ at 60 Hz
- ⁴⁾ Rated operational current at an operating frequency of 16 kHz and an ambient air temperature of +50 °C
- ⁵⁾ Rated operational current at a switching frequency of 8 kHz and an ambient air temperature of +50 °C

Rated operational current ^{1), 4)}	Assigned motor rating ^{1), 2), 3)}		Fitted with	Frame size	Degree of Protection	Part no. Article no.	Price see price list	Std. pack
	I _e A	P kW						
PowerXL variable frequency drives DC1 U _e 115 V AC, single-phase / U ₂ 115 V AC, single-phase Mains voltage (50/60Hz) U _{LN} 110 (-10%) - 115 (+10%) V								
7	0.37	0.5	Radio interference suppression filter Brake chopper 7-digital display assembly Local controls	FS1	IP66/NEMA 4X	DC1-S17D0NN-A66CE1 186074 DC1-S17D0NN-A6SCE1 186075		1 off
10.5	0.55	0.75		FS2		DC1-S1011NB-A66CE1 186077 DC1-S1011NB-A6SCE1 186078		
U _e 230 V AC, 1-phase / U ₂ 230 V AC, single-phase Mains voltage (50/60Hz) U _{LN} 200 (-10%) - 240 (+10%) V								
4.3	0.37	0.5		FS1	IP66/NEMA 4X	DC1-S24D3NN-A66CE1 186080 DC1-S24D3NN-A6SCE1 186081 DC1-S24D3FN-A66CE1 186089 DC1-S24D3FN-A6SCE1 186090		
7	0.75	1				DC1-S27D0NN-A66CE1 186083 DC1-S27D0NN-A6SCE1 186084 DC1-S27D0FN-A66CE1 186092 DC1-S27D0FN-A6SCE1 186093		
10.5	1.1	1.5		FS2		DC1-S2011NB-A66CE1 186086 DC1-S2011NB-A6SCE1 186087 DC1-S2011FB-A66CE1 186095 DC1-S2011FB-A6SCE1 186096		

Notes







- 1) Overload cycle: 150 % for 60 s every 600 s
- 2) DC1-S1...: at 115 V, 50 Hz/at 110 - 120 V, 60 Hz
 DE1-34...:DC1-S2...: at 230 V, 50 Hz/at 220 - 240 V, 60 Hz
- 3) For AC motors with internal and external ventilation with 50/60 Hz without additional start capacitor
- 4) Rated operational current at a switching frequency of 16 kHz and an ambient air temperature of +40 °C

Information relevant for export to North America → Page 17











Rated operational current ^{1), 4)} <i>I_e</i> A	Assigned motor rating ^{1), 2), 3)}		Fitted with Radio interference suppression filter Brake chopper 7-digital display assembly Local controls	Frame size	Degree of Protection	Part no. Article no.	Price see price list	Std. pack
	P kW	P HP						

PowerXL variable frequency drives DC1

U_e 115 V AC, single-phase / U₂ 230 V AC, 3-phase
The mains voltage of 115 V is raised to 230 V (output voltage) through an internal voltage double connection.
Mains voltage (50/60Hz) U_{LN} 110 (-10%) - 115 (+10%) V



2.3	0.37	0.5	-	-	✓	-	FS1	IP66/NEMA 4X	DC1-1D2D3NN-A66CE1 185766	1 off  
			-	-	✓	✓			DC1-1D2D3NN-A6SCE1 185767	
4.3	0.75	1	-	-	✓	-	FS1	IP66/NEMA 4X	DC1-1D4D3NN-A66CE1 185769	1 off  
			-	-	✓	✓			DC1-1D4D3NN-A6SCE1 185770	
5.8	1.1	1.5	-	✓	✓	-	FS2	IP66/NEMA 4X	DC1-1D5D8NB-A66CE1 185772	1 off  
			-	✓	✓	✓			DC1-1D5D8NB-A6SCE1 185773	

U_e 230 V AC, 1-phase / U₂ 230 V AC, 3-phase
Mains voltage (50/60Hz) U_{LN} 200 (-10%) - 240 (+10%) V

2.3	0.37	0.5	-	-	✓	-	FS1	IP66/NEMA 4X	DC1-122D3NN-A66CE1 185786	1 off  
			-	-	✓	✓			DC1-122D3NN-A6SCE1 185787	
			✓	-	✓	-			DC1-122D3FN-A66CE1 185804	
			✓	-	✓	✓			DC1-122D3FN-A6SCE1 185805	
4.3	0.75	1	-	-	✓	-	FS1	IP66/NEMA 4X	DC1-124D3NN-A66CE1 185789	1 off  
			-	-	✓	✓			DC1-124D3NN-A6SCE1 185790	
			✓	-	✓	-			DC1-124D3FN-A66CE1 185807	
			✓	-	✓	✓			DC1-124D3FN-A6SCE1 185808	
7	1.5	2	-	-	✓	-	FS1	IP66/NEMA 4X	DC1-127D0NN-A66CE1 185792	1 off  
			-	-	✓	✓			DC1-127D0NN-A6SCE1 185793	
			✓	-	✓	-			DC1-127D0FN-A66CE1 185810	
			✓	-	✓	✓			DC1-127D0FN-A6SCE1 185811	
			-	✓	✓	-	DC1-127D0NB-A66CE1 185795			
			-	✓	✓	✓	DC1-127D0NB-A6SCE1 185796			
			✓	✓	✓	-	DC1-127D0FB-A66CE1 185813			
			✓	✓	✓	✓	DC1-127D0FB-A6SCE1 185814			
10.5	2.2	3	-	✓	✓	-	FS1	IP66/NEMA 4X	DC1-12011NB-A66CE1 185798	1 off  
			-	✓	✓	✓			DC1-12011NB-A6SCE1 185799	
			✓	✓	✓	-			DC1-12011FB-A66CE1 185816	
			✓	✓	✓	✓			DC1-12011FB-A6SCE1 185817	
15.3 ⁵⁾	4	5	-	✓	✓	-	FS1	IP66/NEMA 4X	DC1-12015NB-A66CE1 185801	1 off  
			-	✓	✓	✓			DC1-12015NB-A6SCE1 185802	

Notes

- 1) Overload cycle: 150 % for 60 s every 600 s
- 2) at 230 V, 50 Hz/at 220 - 240 V, 60 Hz
- 3) for normal internally and externally ventilated 4 pole, three-phase asynchronous motors with 1500 rpm⁻¹ at 50 Hz or 1800 min⁻¹ at 60 Hz
- 4) Rated operational current at a switching frequency of 16 kHz and an ambient air temperature of +40 °C
- 5) Rated operational current at a switching frequency of 8 kHz and an ambient air temperature of +40 °C



  Information relevant for export to North America → Page 17

Rated operational current ^{1), 4)}	Assigned motor rating ^{1), 2), 3)}		Fitted with				Frame size	Degree of Protection	Part no. Article no.	Price see price list	Std. pack
	I _e A	P kW	P HP	Radio interference suppression filter	Brake chopper	7-digital display assembly					
PowerXL variable frequency drives DC1											
U _e 230 V AC, 3-phase / U ₂ 230 V AC, 3-phase Mains voltage (50/60Hz) U _{LN} 200 (-10%) - 240 (+10%) V											
2.3	0.37	0.5	-	-	✓	-	FS1	IP66/NEMA 4X	DC1-322D3NN-A66CE1		1 off
			185819								
4.3	0.75	1	-	-	✓	-	FS1	IP66/NEMA 4X	DC1-322D3NN-A6SCE1		1 off
			185820								
7	1.5	2	-	-	✓	-	FS1	IP66/NEMA 4X	DC1-324D3NN-A66CE1		1 off
			185822								
7	1.5	2	-	-	✓	✓	FS1	IP66/NEMA 4X	DC1-324D3NN-A6SCE1		1 off
			185823								
7	1.5	2	-	-	✓	-	FS2	IP66/NEMA 4X	DC1-327D0NN-A66CE1		1 off
			185825								
7	1.5	2	-	-	✓	✓	FS2	IP66/NEMA 4X	DC1-327D0NN-A6SCE1		1 off
			185826								
7	1.5	2	-	✓	✓	-	FS2	IP66/NEMA 4X	DC1-327D0NB-A66CE1		1 off
			185828								
7	1.5	2	-	✓	✓	✓	FS2	IP66/NEMA 4X	DC1-327D0NB-A6SCE1		1 off
			185829								
7	1.5	2	✓	✓	✓	-	FS2	IP66/NEMA 4X	DC1-327D0FB-A66CE1		1 off
			185837								
7	1.5	2	✓	✓	✓	✓	FS2	IP66/NEMA 4X	DC1-327D0FB-A6SCE1		1 off
			185838								
10.5	2.2	3	-	✓	✓	-	FS2	IP66/NEMA 4X	DC1-32011NB-A66CE1		1 off
			185831								
10.5	2.2	3	-	✓	✓	✓	FS2	IP66/NEMA 4X	DC1-32011NB-A6SCE1		1 off
			185832								
10.5	2.2	3	✓	✓	✓	-	FS2	IP66/NEMA 4X	DC1-32011FB-A66CE1		1 off
			185840								
10.5	2.2	3	✓	✓	✓	✓	FS2	IP66/NEMA 4X	DC1-32011FB-A6SCE1		1 off
			185841								
18 ⁵⁾	4	5	-	✓	✓	-	FS3	IP66/NEMA 4X	DC1-32018NB-A66CE1		1 off
			185834								
18 ⁵⁾	4	5	-	✓	✓	✓	FS3	IP66/NEMA 4X	DC1-32018NB-A6SCE1		1 off
			185835								
18 ⁵⁾	4	5	✓	✓	✓	-	FS3	IP66/NEMA 4X	DC1-32018FB-A66CE1		1 off
			185843								
18 ⁵⁾	4	5	✓	✓	✓	✓	FS3	IP66/NEMA 4X	DC1-32018FB-A6SCE1		1 off
			185720								

Notes



- 1) Overload cycle: 150 % for 60 s every 600 s
- 2) at 230 V, 50 Hz/at 220 - 240 V, 60 Hz
- 3) for normal internally and externally ventilated 4 pole, three-phase asynchronous motors with 1500 rpm⁻¹ at 50 Hz or 1800 min⁻¹ at 60 Hz
- 4) Rated operational current at a switching frequency of 16 kHz and an ambient air temperature of +40 °C
- 5) Rated operational current at a switching frequency of 8 kHz and an ambient air temperature of +40 °C













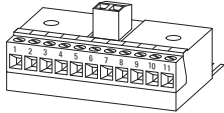

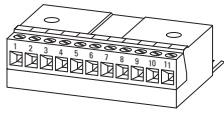
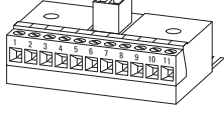
 **Information relevant for export to North America → Page 17**

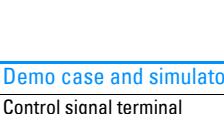
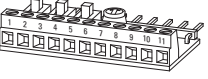

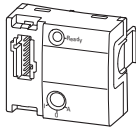

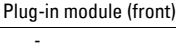

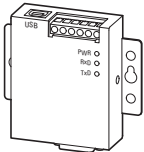

Rated operational current ^{1), 4)} I _e A	Assigned motor rating ^{1), 2), 3)}		Fitted with				Frame size	Degree of Protection	Part no. Article no.	Price see price list	Std. pack
	P kW	P HP	Radio interference suppression filter	Brake chopper	7-digital display assembly	Local controls					
PowerXL variable frequency drives DC1 U _e 400 V AC, 3-phase / U ₂ 400 V AC, 3-phase Mains voltage (50/60Hz) U _{LN} 380 (-10%) - 480 (+10%) V											
2.2	0.75	1	-	-	✓	-	FS1	IP66/NEMA 4X	DC1-342D2NN-A66CE1 185722		1 off  
			-	-	✓	✓			DC1-342D2NN-A6SCE1 185723		
			✓	-	✓	-			DC1-342D2FN-A66CE1 185744		
			✓	-	✓	✓			DC1-342D2FN-A6SCE1 185745		
4.1	1.5	2	-	-	✓	-	FS1	IP66/NEMA 4X	DC1-344D1NN-A66CE1 185725		
			-	-	✓	✓			DC1-344D1NN-A6SCE1 185726		
			✓	-	✓	-			DC1-344D1FN-A66CE1 185747		
			✓	-	✓	✓			DC1-344D1FN-A6SCE1 185748		
			-	✓	✓	-	FS2		DC1-344D1NB-A66CE1 185728		
			-	✓	✓	✓			DC1-344D1NB-A6SCE1 185729		
			✓	✓	✓	-			DC1-344D1FB-A66CE1 185750		
			✓	✓	✓	✓			DC1-344D1FB-A6SCE1 185751		
5.8	2.2	3	-	✓	✓	-			DC1-345D8NB-A66CE1 185731		
			-	✓	✓	✓			DC1-345D8NB-A6SCE1 185732		
			✓	✓	✓	-			DC1-345D8FB-A66CE1 185753		
			✓	✓	✓	✓			DC1-345D8FB-A6SCE1 185754		
9.5	4	5	-	✓	✓	-			DC1-349D5NB-A66CE1 185734		
			-	✓	✓	✓			DC1-349D5NB-A6SCE1 185735		
			✓	✓	✓	-			DC1-349D5FB-A66CE1 185756		
			✓	✓	✓	✓			DC1-349D5FB-A6SCE1 185757		
14 ⁵⁾	5.5	10	-	✓	✓	-	FS3		DC1-34014NB-A66CE1 185737		
			-	✓	✓	✓			DC1-34014NB-A6SCE1 185738		
			✓	✓	✓	-			DC1-34014FB-A66CE1 185759		
			✓	✓	✓	✓			DC1-34014FB-A6SCE1 185760		
18 ⁵⁾	7.5	10	-	✓	✓	-			DC1-34018NB-A66CE1 185740		
			-	✓	✓	✓			DC1-34018NB-A6SCE1 185741		
			✓	✓	✓	-			DC1-34018FB-A66CE1 185762		
			✓	✓	✓	✓			DC1-34018FB-A6SCE1 185763		

Notes

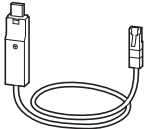
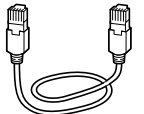
- 1) Overload cycle: 150 % for 60 s every 600 s
- 2) at 400 V, 50 Hz/at 440 - 480 V, 60 Hz
- 3) for normal internally and externally ventilated 4 pole, three-phase asynchronous motors with 1500 rpm⁻¹ at 50 Hz or 1800 min⁻¹ at 60 Hz
- 4) Rated operational current at a switching frequency of 16 kHz and an ambient air temperature of +40 °C
- 5) Rated operational current at a switching frequency of 8 kHz and an ambient air temperature of +40 °C

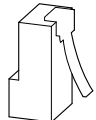
  Information relevant for export to North America → Page 17

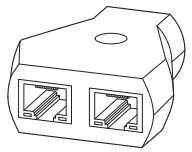
Description	Length	For use with	Part no. Article no.	Price see price list	Std. pack
External keypad					
 With 7-digit display assembly Front IP54 With approx. 3 m-long, plug-in connection cable (RJ45, 8-pin)	3	DE1, DE11, DC1, DA1	DX-KEY-LED2 186946		1 off  
with OLED display Front IP54 Multilingual With approx. 3 m-long, plug-in connection cable (RJ45, 8-pin)	3	DC1, DA1	DX-KEY-OLED 169133		
Expansion modules					
Output expansion					
 2 relay outputs (N/O, 250 V AC/220 V DC, max. 1 A) 1 analog output (0 - +10 V, max. 20 mA) For connecting to the control signal terminals on the DC1	-	DC1	DXC-EXT-2R01A0 169030		1 off  
 2 relay outputs (N/O, 250 V AC/220 V DC, max. 1 A) For connecting to the control signal terminals on the DC1	-	DC1	DXC-EXT-2R0 169031		
Coupling module					
 115-V-AC input (electrically isolated) for 4 digital inputs For connecting to the control signal terminals on the DC1	-	DC1	DXC-EXT-IO110 169032		1 off  
 230-V-AC input (electrically isolated) for 4 digital inputs For connecting to the control signal terminals on the DC1	-	DC1	DXC-EXT-IO230 169033		
Demo case and simulator					
Control signal terminal simulator					
 Commissioning and testing simulator 3 digital inputs (+24 V) 1 relay output (max. 30 V DC) 3 microswitches 1 reference value potentiometer (0 - +10 V / = 0 - f _{max}) For connecting to the control signal terminals on the DC1	-	DC1	DXC-EXT-LOCSIM 169034		1 off  
SmartWire-DT Modules					
 Plug-in module (front) with slot for SWD4-8SF2-5 external device plug	-	DE1, DE11, DC1 (IP20)	DX-NET-SWD3 169131		1 off  
Fieldbus modules					
 Plug-in module (front)	-	DE1, DE11, DC1	DX-NET-ETHERNET2-2 184969		1 off
PC communication					
 Parameter storage unit and Bluetooth communication stick For storage, copying parameters, and/or transferring parameters to a PC with the drivesConnect software via Bluetooth With 2 function keys for uploading and downloading parameters with configuration memory	-	-	DX-COM-STICK2 186947		1 off  

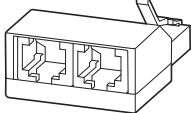
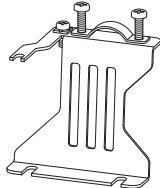
Description	Length	For use with	Part no. Article no.	Price see price list	Std. pack	
PC communication						
Interface converter For directly connecting the variable-frequency drive to a computer with drivesConnect software						
	Interface converter USB/RS485 with connection cable, RJ45, 8 pole electrically isolated 1 x SUB-D plug, 9-pole Terminal strip, 5-terminal Status-LED	-	DE1, DE11, DC1, DA1	DX-COM-PCKIT 169135	1 off  	
	Interface converter USB/RS485 with connection cable, RJ45, 8 pole electrically isolated	3	DE1, DE11, DC1, DA1	DX-CBL-PC-3M0 744-A3036-00P	1 off	
connection cable						
	Patch cord with RJ45 plugs, 8 pole	0.5	DE1, DE11, DC1, DA1	DX-CBL-RJ45-0M5 169137	1 off  	
		1		DX-CBL-RJ45-1M0 169138		
		3		DX-CBL-RJ45-3M0 169139		
Bus terminating resistor						
	RJ45 8 pole Connection to CANopen® (pin 1/2, 124 Ω) or to Modbus RTU (pin 7/8, 120 Ω)	-	easyNet DX-SPL-RJ45-2SL-1PL	EASY-NT-R 256281	2 off  	
Splitter						
	RJ45, 8-pin, 3 sockets	-	DX-CBL-RJ45...	DX-SPL-RJ45-3SL 169141	1 off  	
	RJ45, 8-pin, 2 sockets/1 plug	-	DE1, DE11, DC1, DA1	DX-SPL-RJ45-2SL1PL 169142		
	RJ45, 8-pin, 2 sockets/1 plug for CANopen® and Modbus RTU	-	DE1, DE11, DC1 (IP20), DA1 (IP20)	DX-SPL-RJ45 179313	1 off	
	RJ45, 8 pole, 1 socket/1 plug for CANopen® and Modbus RTU With 2 resistors, 120 Ω	-	DE1, DE11, DC1 (IP20), DA1 (IP20)	DX-SPL-RJ45-TERM 179314		
mounting accessories						
mounting adapter With gland plates						
	For installing the connection cables on the mains side	Size FS1	-	DC1	DX-EMC-MNT-1N 172925	1 off
		Size FS2	-	DC1, DA1, DL1	DX-EMC-MNT-2N 172927	
		Size FS3	-	DC1, DA1, DL1	DX-EMC-MNT-3N 172929	
	For installing the connection cables on the motor side	Size FS1	-	DC1	DX-EMC-MNT-1M 172926	
		Size FS2	-	DC1, DA1, DL1	DX-EMC-MNT-2M 172928	
		Size FS3	-	DC1, DA1, DL1	DX-EMC-MNT-3M 172930	



Information relevant for export to North America

Product Standards	UL 508C; CSA-C22.2 No. 14; IEC/EN61800-3; IEC/EN61800-5; CE marking
UL File No.	E172143
UL Category Control No.	NMMS, NMMS7
CSA File No.	UL report applies to both US and Canada
North America Certification Suitable for	UL listed, certified by UL for use in Canada Branch circuits

EASY-NT-R:

Product Standards	IEC/EN see Technical Data; UL 508; CSA C22.2 No. 142-M1987; CSA C22.2 No. 213-M1987; CE marking
UL File No.	E135462
UL Category Control No.	NRAQ
CSA File No.	012528
CSA Class No.	2258-02
North America Certification	UL listed, CSA certified
Degree of Protection	toIEC: IP20, UL/CSA Type: -



PowerXL Variable Frequency Drive DA1 Advanced Machinery Drive

The PowerXL DA1 variable frequency drive, designed for the machine and system building industry, is characterized by its enormous flexibility in terms of communications protocols, a function block editor (PLC) that makes it possible to configure the drive as necessary for specific applications, and a powerful vector control mode for highly dynamic applications.

Performance range:

- 0.75 ... 2.2 kW (U_g : 1~ 230 V, U_2 : 3~ 230 V)
- 0.75 ... 75 kW (U_g : 3~ 230 V, U_2 : 3~ 230 V)
- 0.75 ... 250 kW (U_g : 3~ 400 V, U_2 : 3~ 400 V)
- 0.75 ... 110 kW (U_g : 3~ 575 V, U_2 : 3~ 575 V)

Features:

- Large overload capability: 150% for 60 seconds, 200% for 4 seconds
- Integrated Modbus RTU and CANopen
- Ambient air temperature up to 50 °C without derating
- Integrated EMC filter
- Integrated braking transistor
- Various I/O expansions
- V/F control, vector SL and CL, PM motor, BLDC motor, SynRel motor
- Optional field bus connections
- Safe Torque Off (STO, SIL 2/PI d)
- Optional high-resolution OLED display
- International standards (CE, UL, cUL, RCM, RoHS, EAC, UkrSEPRO, DNV (754–757))

Accessories:

- SmartWire-DT connection
- Communication modules (PROFIBUS, PROFINET, Ethernet/IP, EtherCAT, DeviceNet, etc.)
- I/O expansions
- External keypad
- Mains chokes
- Motor chokes
- Sine filters
- Braking resistances
- drivesConnect parameter configuration software
- External EMC filter

Applications:

- Winding machines
- Respooler machines
- Coating systems
- Compressors
- Mills, roller mills, shredders
- Extruders
- Cranes and lifting systems
- Marine
- Distributed applications (IP66)



System overview	30
Key to type references	31
UL/CSA	31
Sizes and degree of protection	32
Ordering	
Variable frequency drives DA1, IP20/IP55	33
Variable frequency drives DA1, IP66	36
Accessories	38

System overview

DA1 with IP20 degree of protection

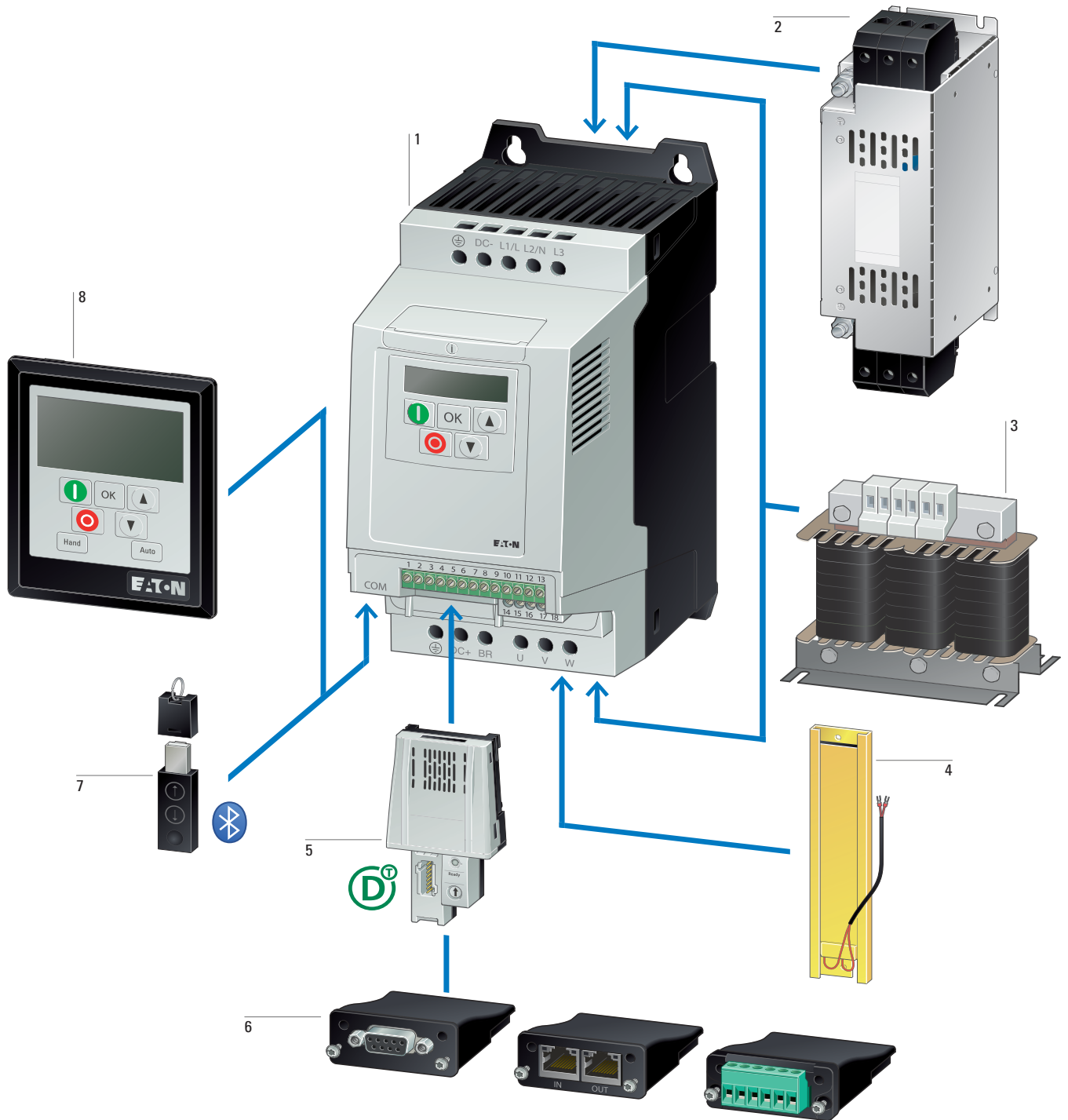

DA1 variable frequency drives 1

→ page 33

External radio interference suppression filter 2

→ page 54

Mains choke, motor choke, sine filter 3

→ page 60, → page 61

Braking resistance 4

→ page 56

SmartWire-DT module 5

→ page 38

Communication modules, expansion modules 6

→ page 38

Memory and Bluetooth communication stick 7

→ page 39

External keypad 8

→ page 38

Key to type references

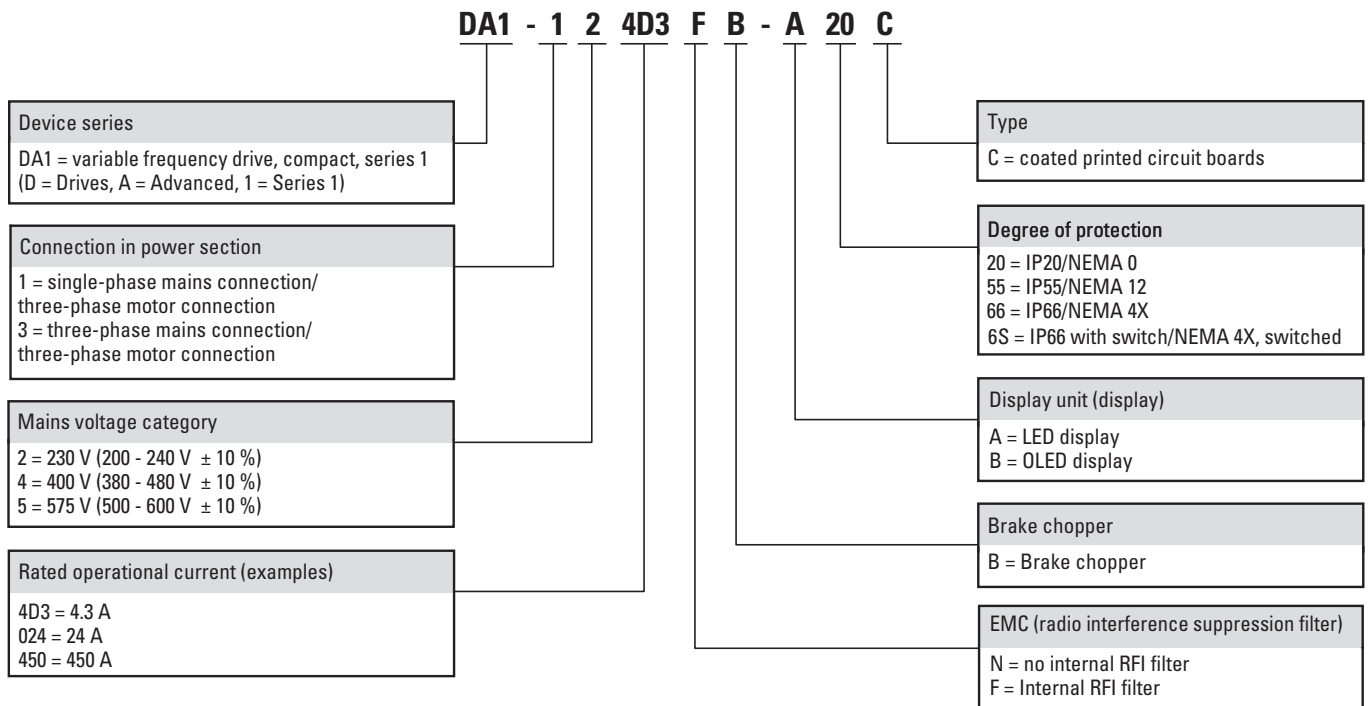

DA1

UL/CSA

Information relevant for export to North America

Product Standards	UL 508C; CSA-C22.2 No. 14; IEC/EN61800-3; IEC/EN61800-5; CE marking
UL File No.	E172143
UL Category Control No.	NMMS, NMMS7
CSA File No.	UL report applies to both US and Canada
North America Certification	UL listed, certified by UL for use in Canada
Suitable for	Branch circuits
Max. Voltage Rating	3~ 240 V AC IEC: TN-S UL/CSA: "Y" (Solidly Grounded Wey) 3~ 480 V AC IEC: TN-S UL/CSA: "Y" (Solidly Grounded Wey)

Sizes and degree of protection

Frame size Degree of Protection
IP20/NEMA 0

IP66/NEMA 4X

IP66/NEMA 4X
Local controls

FS2

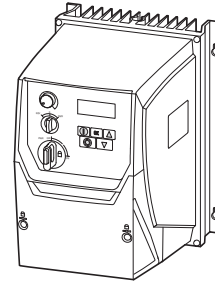
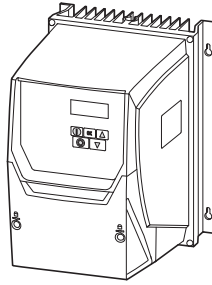
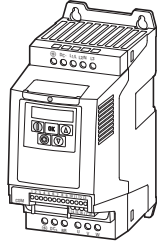

FS3

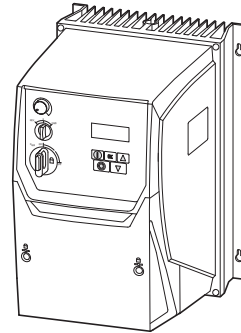
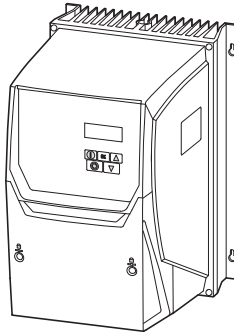
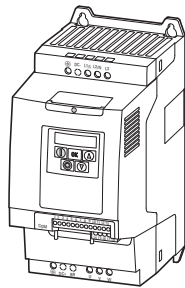

Frame size Degree of Protection
IP55/NEMA 12

Frame size Degree of Protection
IP20/NEMA 0

FS4-FS7

FS8

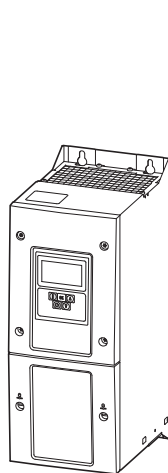

FS4



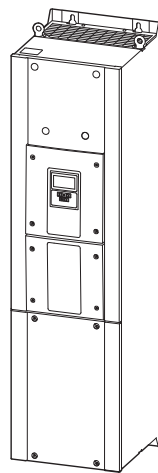

...

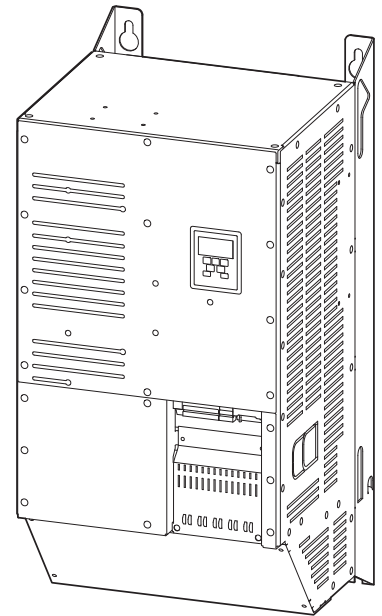

FS7



Note: Figures are not true to scale

Rated operational current ^{1), 4)} <i>I_e</i> A	Assigned motor rating ^{1), 2), 3)}		Fitted with							Frame size	Degree of Protection	Part no. Article no.	Price see price list	Std. pack
	P kW	P HP	Radio interference suppression filter	Brake chopper	DC link choke	7-digital display assembly	OLED display	Additional PCB protection	Local controls					
PowerXL variable frequency drives DA1														
U _e 230 V AC, 1-phase / U ₂ 230 V AC, 3-phase Mains voltage (50/60Hz) U _{LN} 200 (-10%) - 240 (+10%) V														
4.3	0.75	1	✓	✓	-	✓	-	✓	-	FS2	IP20/NEMA 0	DA1-124D3FB-A20C 169078	1 off  	
7	1.5	2	✓	✓	-	✓	-	✓	-			DA1-127D0FB-A20C 169081		
10.5	2.2	3	✓	✓	-	✓	-	✓	-			DA1-12011FB-A20C 169084		
U _e 230 V AC, 3-phase / U ₂ 230 V AC, 3-phase Mains voltage (50/60Hz) U _{LN} 200 (-10%) - 240 (+10%) V														
4.3	0.75	1	✓	✓	-	✓	-	✓	-	FS2	IP20/NEMA 0	DA1-324D3FB-A20C 169087	1 off  	
7	1.5	2	✓	✓	-	✓	-	✓	-			DA1-327D0FB-A20C 169090		
10.5	2.2	3	✓	✓	-	✓	-	✓	-			DA1-32011FB-A20C 169093		
18	4	5	✓	✓	-	✓	-	✓	-	FS3		DA1-32018FB-A20C 169096		
24	5.5	7.5	✓	✓	-	✓	-	✓	-			DA1-32024FB-A20C 169099		
24 ⁵⁾			✓	✓	-	-	✓	✓	-	FS4	IP55/NEMA 12	DA1-32024FB-B55C 169361		
30	7.5	10	✓	✓	-	-	✓	✓	-			DA1-32030FB-B55C 169362		
46	11	15	✓	✓	-	-	✓	✓	-			DA1-32046FB-B55C 169363		
61	15	20	✓	✓	✓	-	✓	✓	-	FS5		DA1-32061FB-B55C 169364		
72	18.5	25	✓	✓	✓	-	✓	✓	-			DA1-32072FB-B55C 169365		
90 ⁵⁾	22	30	✓	✓	✓	-	✓	✓	-	FS6		DA1-32090FB-B55C 169367		
110 ⁵⁾	30	40	✓	✓	✓	-	✓	✓	-			DA1-32110FB-B55C 169369		
150 ⁵⁾	45	50	✓	✓	✓	-	✓	✓	-			DA1-32150FB-B55C 169371		
180 ⁵⁾	55	60	✓	✓	✓	-	✓	✓	-			DA1-32180FB-B55C 169373		
202 ⁵⁾		75	✓	✓	✓	-	✓	✓	-	FS7		DA1-32202FB-B55C 169375		
248 ⁵⁾	75	100	✓	✓	✓	-	✓	✓	-			DA1-32248FB-B55C 169377		

Notes

- 1) Overload cycle for 60 s every 600 s
- 2) at 230 V, 50 Hz/at 220 - 240 V, 60 Hz
- 3) for normal internally and externally ventilated 4 pole, three-phase asynchronous motors with 1500 rpm⁻¹ at 50 Hz or 1800 min⁻¹ at 60 Hz
- 4) IP20/NEMA 0: Rated operational current at an operating frequency of 16 kHz and an ambient air temperature of +50 °C
DE1-34...:IP55/NEMA 12: Rated operational current at a switching frequency of 16 kHz and an ambient air temperature of +40 °C
- 5) IP20/NEMA 0: Rated operational current at a switching frequency of 8 kHz and an ambient air temperature of +50 °C
DE1-34...:IP55/NEMA 12: Rated operational current at a switching frequency of 8 kHz and an ambient air temperature of +40 °C





Information relevant for export to North America → Page 31

Rated operational current ^{1), 4)} <i>I_e</i> A	Assigned motor rating ^{1), 2), 3)}		Fitted with								Frame size	Degree of Protection	Part no. Article no.	Price see price list	Std. pack
	P kW	P HP	Radio interference suppression filter	Brake chopper	DC link choke	7-digital display assembly	OLED display	Additional PCB protection	Local controls						
PowerXL variable frequency drives DA1															
U _e 400 V AC, 3-phase / U ₂ 400 V AC, 3-phase Mains voltage (50/60Hz) U _{LN} 380 (-10%) - 480 (+10%) V															
2.2	0.75	1	✓	✓	-	✓	-	✓	-	FS2	IP20/NEMA 0	DA1-342D2FB-A20C 169117	1 off 		
4.1	1.5	2	✓	✓	-	✓	-	✓	-						
5.8	2.2	3	✓	✓	-	✓	-	✓	-						
9.5	4	5	✓	✓	-	✓	-	✓	-						
14	5.5	7.5	✓	✓	-	✓	-	✓	-	FS3					
18	7.5	10	✓	✓	-	✓	-	✓	-	FS4	IP55/NEMA 12	DA1-34014FB-A20C 169057			
24	11	15	✓	✓	-	✓	-	✓	-			DA1-34018FB-A20C 169060			
30	15	20	✓	✓	-	-	✓	✓	-	FS5	IP55/NEMA 12	DA1-34024FB-A20C 169063			
39	18.5	25	✓	✓	-	-	✓	✓	-			DA1-34024FB-B55C 169390			
46	22	30	✓	✓	-	-	✓	✓	-			DA1-34030FB-B55C 169391			
61	30	40	✓	✓	✓	-	✓	✓	-			DA1-34039FB-B55C 169392			
72	37	50	✓	✓	✓	-	✓	✓	-			DA1-34046FB-B55C 169393			
90 ⁵⁾	45	60	✓	✓	✓	-	✓	✓	-	FS6	IP55/NEMA 12	DA1-34061FB-B55C 169394			
110 ⁵⁾	55	75	✓	✓	✓	-	✓	✓	-			DA1-34072FB-B55C 169395			
150 ⁵⁾	75	100	✓	✓	✓	-	✓	✓	-			DA1-34090FB-B55C 169397			
180 ⁵⁾	90	125	✓	✓	✓	-	✓	✓	-			DA1-34110FB-B55C 169399			
202 ⁵⁾	110	150	✓	✓	✓	-	✓	✓	-			DA1-34150FB-B55C 169401			
240 ⁵⁾	132	200	✓	✓	✓	-	✓	✓	-	FS7	IP55/NEMA 12	DA1-34180FB-B55C 169403			
302 ⁵⁾	160	250	✓	✓	✓	-	✓	✓	-			DA1-34202FB-B55C 169405			
370 ⁵⁾	200	300	✓	✓	-	-	✓	✓	-			DA1-34240FB-B55C 169407			
450 ⁵⁾	250	350	✓	✓	-	-	✓	✓	-	FS8	IP20/NEMA 0	DA1-34302FB-B55C 169217			
												DA1-34370FB-B20C 169219			
												DA1-34450FB-B20C 169221			

Notes



- 1) Overload cycle for 60 s every 600 s
- 2) at 400 V, 50 Hz/at 440 - 480 V, 60 Hz
- 3) for normal internally and externally ventilated 4 pole, three-phase asynchronous motors with 1500 rpm⁻¹ at 50 Hz or 1800 min⁻¹ at 60 Hz
- 4) IP20/NEMA 0: Rated operational current at a switching frequency of 8 kHz and an ambient air temperature of +50 °C
DE1-34...:IP55/NEMA 12: Rated operational current at a switching frequency of 8 kHz and an ambient air temperature of +40 °C
- 5) IP20/NEMA 0: Rated operational current at an operating frequency of 4 kHz and an ambient air temperature of +50 °C
DE1-34...:IP55/NEMA 12: Rated operational current at an operating frequency of 4 kHz and an ambient air temperature of +40 °C

 Information relevant for export to North America → Page 31





Rated operational current ^{1), 4)} I _e A	Assigned motor rating ^{1), 2), 3)}		Fitted with							Frame size	Degree of Protection	Part no. Article no.	Price see price list	Std. pack
	P kW	P HP	Radio interference suppression filter	Brake chopper	DC link choke	7-digit display assembly	OLED display	Additional PCB protection	Local controls					
PowerXL variable frequency drives DA1														
U _e 500 V AC, 3-phase / U ₂ 500 V AC, 3-phase Mains voltage (50/60Hz) U _{LN} 500 (-10%) - 600 (+10%) V														
2.1	0.75	1	-	✓	-	✓	-	✓	-	FS2	IP20/NEMA 0	DA1-352D1NB-A20C 177034	1 off  	
3.1	1.5	2	-	✓	-	✓	-	✓	-			DA1-353D1NB-A20C 177035		
4.1	2.2	3	-	✓	-	✓	-	✓	-			DA1-354D1NB-A20C 177036		
6.5	4	5	-	✓	-	✓	-	✓	-			DA1-356D5NB-A20C 177037		
9	5.5	7.5	-	✓	-	✓	-	✓	-			DA1-359D0NB-A20C 177038		
12	7.5	10	-	✓	-	✓	-	✓	-	FS3		DA1-35012NB-A20C 177039		
17	11	15	-	✓	-	✓	-	✓	-		DA1-35017NB-A20C 177040			
22	15	20	-	✓	-	✓	-	✓	-		DA1-35022NB-A20C 177041			
28	18.5	25	-	✓	-	-	✓	✓	-	FS4	IP55/NEMA 12	DA1-35022NB-B55C 176965		
34	22	30	-	✓	-	-	✓	✓	-			DA1-35028NB-B55C 176966		
43	30	40	-	✓	✓	-	✓	✓	-	FS5	DA1-35034NB-B55C 176967			
54	37	50	-	✓	✓	-	✓	✓	-		DA1-35043NB-B55C 176968			
65	45	60	-	✓	✓	-	✓	✓	-		DA1-35054NB-B55C 176969			
78 ⁵⁾	55	75	-	✓	✓	-	✓	✓	-	FS6	DA1-35065NB-B55C 176970			
105 ⁵⁾	75	100	-	✓	✓	-	✓	✓	-		DA1-35078NB-B55C 176971			
130 ⁵⁾	90	125	-	✓	✓	-	✓	✓	-		DA1-35105NB-B55C 176972			
150 ⁵⁾	110	150	-	✓	✓	-	✓	✓	-		DA1-35130NB-B55C 176973			
			-	✓	✓	-	✓	✓	-		DA1-35150NB-B55C 176974			

Notes

- 1) Overload cycle for 60 s every 600 s
- 2) at 500 V, 50 Hz/at 550 - 600 V, 60 Hz
- 3) for normal internally and externally ventilated 4 pole, three-phase asynchronous motors with 1500 rpm⁻¹ at 50 Hz or 1800 min⁻¹ at 60 Hz
- 4) IP20/NEMA 0: Rated operational current at a switching frequency of 8 kHz and an ambient air temperature of +50 °C
DE1-34...:IP55/NEMA 12: Rated operational current at a switching frequency of 8 kHz and an ambient air temperature of +40 °C
- 5) IP20/NEMA 0: Rated operational current at an operating frequency of 4 kHz and an ambient air temperature of +50 °C
DE1-34...:IP55/NEMA 12: Rated operational current at an operating frequency of 4 kHz and an ambient air temperature of +40 °C



  **Information relevant for export to North America → Page 31**





DA1

Rated operational current ^{1), 4)} <i>I_e</i> A	Assigned motor rating ^{1), 2), 3)}		Fitted with							Frame size	Degree of Protection	Part no. Article no.	Price see price list	Std. pack
	P kW	P HP	Radio interference suppression filter	Brake chopper	DC link choke	7-digital display assembly	OLED display	Additional PCB protection	Local controls					
PowerXL variable frequency drives DA1														
U _e 230 V AC, 1-phase / U ₂ 230 V AC, 3-phase Mains voltage (50/60Hz) U _{LN} 200 (-10%) - 240 (+10%) V														
4.3	0.75	1	✓	✓	-	-	✓	✓	-	FS2	IP66/NEMA 4X	DA1-124D3FB-B66C 169347		1 off  
			✓	✓	-	-	✓	✓	✓			DA1-124D3FB-B6SC 169348		
7	1.5	2	✓	✓	-	-	✓	✓	-	FS2	IP66/NEMA 4X	DA1-127D0FB-B66C 169349		
			✓	✓	-	-	✓	✓	✓			DA1-127D0FB-B6SC 169350		
10.5	2.2	3	✓	✓	-	-	✓	✓	-	FS2	IP66/NEMA 4X	DA1-12011FB-B66C 169351		
			✓	✓	-	-	✓	✓	✓			DA1-12011FB-B6SC 169352		
U _e 230 V AC, 3-phase / U ₂ 230 V AC, 3-phase Mains voltage (50/60Hz) U _{LN} 200 (-10%) - 240 (+10%) V														
4.3	0.75	1	✓	✓	-	-	✓	✓	-	FS2	IP66/NEMA 4X	DA1-324D3FB-B66C 169353		1 off  
			✓	✓	-	-	✓	✓	✓			DA1-324D3FB-B6SC 169354		
7	1.5	2	✓	✓	-	-	✓	✓	-	FS2	IP66/NEMA 4X	DA1-327D0FB-B66C 169355		
			✓	✓	-	-	✓	✓	✓			DA1-327D0FB-B6SC 169356		
10.5	2.2	3	✓	✓	-	-	✓	✓	-	FS2	IP66/NEMA 4X	DA1-32011FB-B66C 169357		
			✓	✓	-	-	✓	✓	✓			DA1-32011FB-B6SC 169358		
18	4	5	✓	✓	-	-	✓	✓	-	FS3	IP66/NEMA 4X	DA1-32018FB-B66C 169359		
			✓	✓	-	-	✓	✓	✓			DA1-32018FB-B6SC 169360		

Notes



- 1) Overload cycle for 60 s every 600 s
- 2) at 230 V, 50 Hz/at 220 - 240 V, 60 Hz
- 3) for normal internally and externally ventilated 4 pole, three-phase asynchronous motors with 1500 rpm⁻¹ at 50 Hz or 1800 min⁻¹ at 60 Hz
- 4) Rated operational current at a switching frequency of 16 kHz and an ambient air temperature of +40 °C

  **Information relevant for export to North America → Page 31**







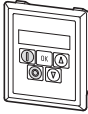

Rated operational current ^{1), 4)} I _e A	Assigned motor rating ^{1), 2), 3)} P kW P HP	Fitted with	Frame size	Degree of Protection	Part no. Article no.	Price see price list	Std. pack							
		Radio interference suppression filter Brake chopper DC link choke 7-digital display assembly OLED display Additional PCB protection Local controls												
PowerXL variable frequency drives DA1														
U _e 400 V AC, 3-phase / U ₂ 400 V AC, 3-phase Mains voltage (50/60Hz) U _{LN} 380 (-10%) - 480 (+10%) V														
2.2	0.75	1	✓	✓	-	-	✓	✓	-	FS2	IP66/NEMA 4X	DA1-342D2FB-B66C 169378		1 off  
			✓	✓	-	-	✓	✓	✓			DA1-342D2FB-B66SC 169379		
4.1	1.5	2	✓	✓	-	-	✓	✓	-	FS2	IP66/NEMA 4X	DA1-344D1FB-B66C 169380		
			✓	✓	-	-	✓	✓	✓			DA1-344D1FB-B66SC 169381		
5.8	2.2	3	✓	✓	-	-	✓	✓	-	FS2	IP66/NEMA 4X	DA1-345D8FB-B66C 169382		
			✓	✓	-	-	✓	✓	✓			DA1-345D8FB-B66SC 169383		
9.5	4	5	✓	✓	-	-	✓	✓	-	FS2	IP66/NEMA 4X	DA1-349D5FB-B66C 169384		
			✓	✓	-	-	✓	✓	✓			DA1-349D5FB-B66SC 169385		
14	5.5	7.5	✓	✓	-	-	✓	✓	-	FS3	IP66/NEMA 4X	DA1-34014FB-B66C 169386		
			✓	✓	-	-	✓	✓	✓			DA1-34014FB-B66SC 169387		
18	7.5	10	✓	✓	-	-	✓	✓	-	FS3	IP66/NEMA 4X	DA1-34018FB-B66C 169388		
			✓	✓	-	-	✓	✓	✓			DA1-34018FB-B66SC 169389		
U _e 500 V AC, 3-phase / U ₂ 500 V AC, 3-phase Mains voltage (50/60Hz) U _{LN} 500 (-10%) - 600 (+10%) V														
2.1	0.75	1	-	✓	-	-	✓	✓	-	FS2	IP66/NEMA 4X	DA1-352D1NB-B66C 176984		1 off  
			-	✓	-	-	✓	✓	✓			DA1-352D1NB-B66SC 177012		
3.1	1.5	2	-	✓	-	-	✓	✓	-	FS2	IP66/NEMA 4X	DA1-353D1NB-B66C 176985		
			-	✓	-	-	✓	✓	✓			DA1-353D1NB-B66SC 177013		
4.1	2.2	3	-	✓	-	-	✓	✓	-	FS2	IP66/NEMA 4X	DA1-354D1NB-B66C 176986		
			-	✓	-	-	✓	✓	✓			DA1-354D1NB-B66SC 177014		
6.5	4	5	-	✓	-	-	✓	✓	-	FS2	IP66/NEMA 4X	DA1-356D5NB-B66C 176987		
			-	✓	-	-	✓	✓	✓			DA1-356D5NB-B66SC 177015		
9	5.5	7.5	-	✓	-	-	✓	✓	-	FS2	IP66/NEMA 4X	DA1-359D0NB-B66C 176988		
			-	✓	-	-	✓	✓	✓			DA1-359D0NB-B66SC 177016		
12	7.5	10	-	✓	-	-	✓	✓	-	FS3	IP66/NEMA 4X	DA1-35012NB-B66C 176989		
			-	✓	-	-	✓	✓	✓			DA1-35012NB-B66SC 177017		
17	11	15	-	✓	-	-	✓	✓	-	FS3	IP66/NEMA 4X	DA1-35017NB-B66C 176990		
			-	✓	-	-	✓	✓	✓			DA1-35017NB-B66SC 177018		

Notes

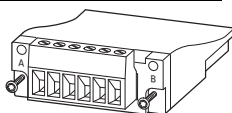
- ¹⁾ Overload cycle for 60 s every 600 s
- ²⁾ DA1-34...: at 400 V, 50 Hz/at 440 - 480 V, 60 Hz/DA1-35...: at 500 V, 50 Hz/at 550 - 600 V, 60 Hz
- ³⁾ for normal internally and externally ventilated 4 pole, three-phase asynchronous motors with 1500 rpm⁻¹ at 50 Hz or 1800 min⁻¹ at 60 Hz
- ⁴⁾ Rated operational current at a switching frequency of 8 kHz and an ambient air temperature of +40 °C

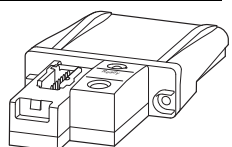
  Information relevant for export to North America → Page 31

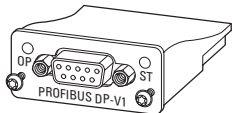

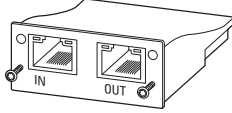
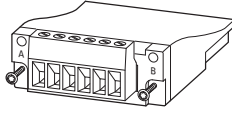





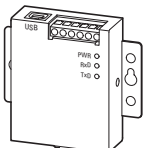

DA1

	Description	Length m	For use with	Part no. Article no.	Price see price list	Std. pack
External keypad						
	With 7-digit display assembly Front IP54 With approx. 3 m-long, plug-in connection cable (RJ45, 8-pin)	3	DE1, DE11, DC1, DA1	DX-KEY-LED2 186946		1 off  
	with OLED display Front IP54 Multilingual With approx. 3 m-long, plug-in connection cable (RJ45, 8-pin)	3	DC1, DA1	DX-KEY-OLED 169133		
Expansion modules						
	Output expansion Plug-in module with plug-in terminal block, 5 pole 3 relay outputs (N/O, 250 V AC, max. 6 A/ 30 V DC, max. 5 A)	-	DA1	DXA-EXT-3RO 169121		1 off  
	I/O expansion Plug-in module with plug-in terminal blocks, 6 pole 3 digital inputs (+24 V) 1 relay output (N/O, 250 V AC, max. 6 A/ 30 V DC, max. 5 A)	-	DA1	DXA-EXT-3DI1RO 169036		
	Encoder module Plug-in module with plug-in terminal block, 5 pole 2-channel max. 500 kHz 5 V TTL, A & B, /A & /B, 5 V DC, max. 200 mA 24 V HTL, A & B, /A & /B, 24 V DC, external power supply required, max. 30 V DC	-	DA1	DXA-EXT-ENCOD 169035		
SmartWire-DT Modules						
	Plug-in module with slot for SWD4-8SF2-5 external device plug	-	DA1 (IP20, IP55)	DX-NET-SWD1 169129		1 off  
Fieldbus modules						
	PROFIBUS-DP SUB-D socket, 9-pole	-	DA1	DX-NET-PROFIBUS 169124		1 off  
	PROFINET 2 x RJ45, 8 pole Plug-in module	-	DA1	DX-NET-PROFINET-2 169125		
	Modbus TCP 2 x RJ45, 8 pole Plug-in module	-	DA1	DX-NET-MODBUSTCP-2 169126		
	EtherNet-IP 2 x RJ45, 8 pole Plug-in module	-	DA1	DX-NET-ETHERNET-2 169122		
	EtherCAT 2 x RJ45, 8 pole Plug-in module	-	DA1	DX-NET-ETHERCAT-2 169127		
	DeviceNet Plug-in module with plug-in terminal blocks, 6 pole	-	DA1	DX-NET-DEVICENET 169123		

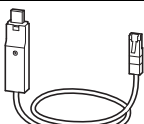
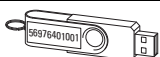
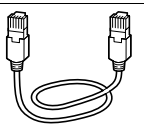
  **Information relevant for export to North America**

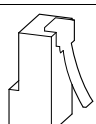
Product Standards	UL 508C; CSA-C22.2 No. 14; IEC/EN61800-3; IEC/EN61800-5; CE marking
UL File No.	E172143
UL Category Control No.	NMMS, NMMS7
CSA File No.	UL report applies to both US and Canada
North America Certification	UL listed, certified by UL for use in Canada
Suitable for	Branch circuits

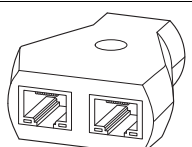
DA1

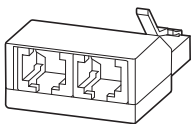
Description	Length m	For use with	Part no. Article no.	Price see price list	Std. pack
PC communication					
Parameter storage unit and Bluetooth communication stick					
 For storage, copying parameters, and/or transferring parameters to a PC with the drivesConnect software via Bluetooth With 2 function keys for uploading and downloading parameters with configuration memory	-	-	DX-COM-STICK2 186947		1 off  
Interface converter For directly connecting the variable-frequency drive to a computer with drivesConnect software					
 Interface converter USB/RS485 with connection cable, RJ45, 8 pole electrically isolated 1 x SUB-D plug, 9-pole Terminal strip, 5-terminal Status-LED	-	DE1, DE11, DC1, DA1	DX-COM-PCKIT 169135		1 off  
 Interface converter USB/RS485 with connection cable, RJ45, 8 pole electrically isolated	3	DE1, DE11, DC1, DA1	DX-CBL-PC-3M0 744-A3036-00P		1 off
License Keys to activate the function block editor in the DrivesConnect software					
 USB flash drive	-	DA1	DX-COM-SOFT 169136		
connection cable					
	Patch cord with RJ45 plugs, 8 pole	0.5	DE1, DE11, DC1, DA1	DX-CBL-RJ45-0M5 169137	1 off  
		1		DX-CBL-RJ45-1M0 169138	
		3		DX-CBL-RJ45-3M0 169139	
Bus terminating resistor					
 RJ45 8 pole Connection to CANopen® (pin 1/2, 124 Ω) or to Modbus RTU (pin 7/8, 120 Ω)	-	easyNet DX-SPL-RJ45-2SL-1PL	EASY-NT-R 256281		2 off  
Splitter					
	RJ45, 8-pin, 3 sockets	-	DX-CBL-RJ45...	DX-SPL-RJ45-3SL 169141	1 off  
	RJ45, 8-pin, 2 sockets/1 plug	-	DE1, DE11, DC1, DA1	DX-SPL-RJ45-2SL1PL 169142	
	RJ45, 8-pin, 2 sockets/1 plug for CANopen® and Modbus RTU	-	DE1, DE11, DC1 (IP20), DA1 (IP20)	DX-SPL-RJ45 179313	1 off
	RJ45, 8 pole, 1 socket/1 plug for CANopen® and Modbus RTU With 2 resistors, 120 Ω	-	DE1, DE11, DC1 (IP20), DA1 (IP20)	DX-SPL-RJ45-TERM 179314	



Information relevant for export to North America

Product Standards	UL 508C; CSA-C22.2 No. 14; IEC/EN61800-3; IEC/EN61800-5; CE marking
UL File No.	E172143
UL Category Control No.	NMMS, NMMS7
CSA File No.	UL report applies to both US and Canada
North America Certification Suitable for	UL listed, certified by UL for use in Canada Branch circuits

EASY-NT-R:

Product Standards	IEC/EN see Technical Data; UL 508; CSA C22.2 No. 142-M1987; CSA C22.2 No. 213-M1987; CE marking
UL File No.	E135462
UL Category Control No.	NRAQ
CSA File No.	012528
CSA Class No.	2258-02
North America Certification	UL listed, CSA certified
Degree of Protection	IEC: IP20, UL/CSA Type: -

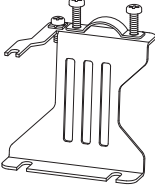
Description	Length m	For use with	Part no. Article no.	Price see price list	Std. pack
mounting accessories					
mounting adapter With gland plates					
	For installing the connection cables on the mains side	Size FS2	-	DC1, DA1, DL1	1 off
		Size FS3	-	DC1, DA1, DL1	
	For installing the connection cables on the motor side	Size FS2	-	DC1, DA1, DL1	DX-EMC-MNT-2N 172927
		Size FS3	-	DC1, DA1, DL1	DX-EMC-MNT-3N 172929
				DX-EMC-MNT-2M 172928	
				DX-EMC-MNT-3M 172930	

 **Information relevant for export to North America**

Product Standards	UL 508C; CSA-C22.2 No. 14; IEC/EN61800-3; IEC/EN61800-5; CE marking
UL File No.	E172143
UL Category Control No.	NMMS, NMMS7
CSA File No.	UL report applies to both US and Canada
North America Certification	UL listed, certified by UL for use in Canada
Suitable for	Branch circuits



PowerXL Variable Frequency Drive DG1 General Purpose Drive

PowerXL DG1 general-purpose drives are variable frequency drives in Eaton's "Next-Generation" PowerXL series. They are specifically designed for modern, sophisticated applications:

In fact, energy-saving algorithms, high short-circuit values, and a heavy-duty design all enable them to provide maximum efficiency, safety, and reliability.

Performance range:

- 0.75 ... 90 kW (U_g : 3~ 230 V, U_2 : 3~ 230 V)
- 0.75 ... 160 kW (U_g : 3~ 400 V, U_2 : 3~ 400 V)

Features:

- **Ease of use:** Startup Wizard, inControl PC Tool software, four built-in applications, diagnostics, local/remote button, removable keypad with copy/paste functionality.
- **Communicative:** Modbus RTU, Modbus TCP, Ethernet IP and BacNet MS/TP Standard on each device. In addition to that extensive I/O above the standard in this device class
- **Efficiency:** Active energy control algorithm, 5% DC choke, input surge protection, EMC filter built-in
- **Rugged and reliable:** Dual rating with high (CT) and low (VT) overload capability, conformal coated boards, brake chopper circuit, durable metal power section, 50°C rating (60°C de-rating), removable keypad rated IP54
- **Global acceptance:** UL®, CE, cUL®, RoHS, RCM

Accessories:

- Communication modules (PROFIBUS, PROFINET, DeviceNet, etc.)
- I/O expansions
- External keypad
- Motor chokes
- Sine filters
- Braking resistances
- Power Xpert inControl operating software

Applications:

- Multi-pump applications
- HVAC
- Roller and chain conveyors
- Compressors, mills
- Production machines
- Centrifuges and extruders
- Traction drives, conveyor belts
- Sawing, drilling, dosing unit drives
- Chemical and primary industries
- Water jet cutting, crushers



System overview	44
Key to type references	45
Sizes and degree of protection	45
UL/CSA	45
Ordering	
Variable frequency drives DG1, IP21	46
Variable frequency drives DG1, IP54	48
Accessories	50

System overview

DG1, frame size FR1

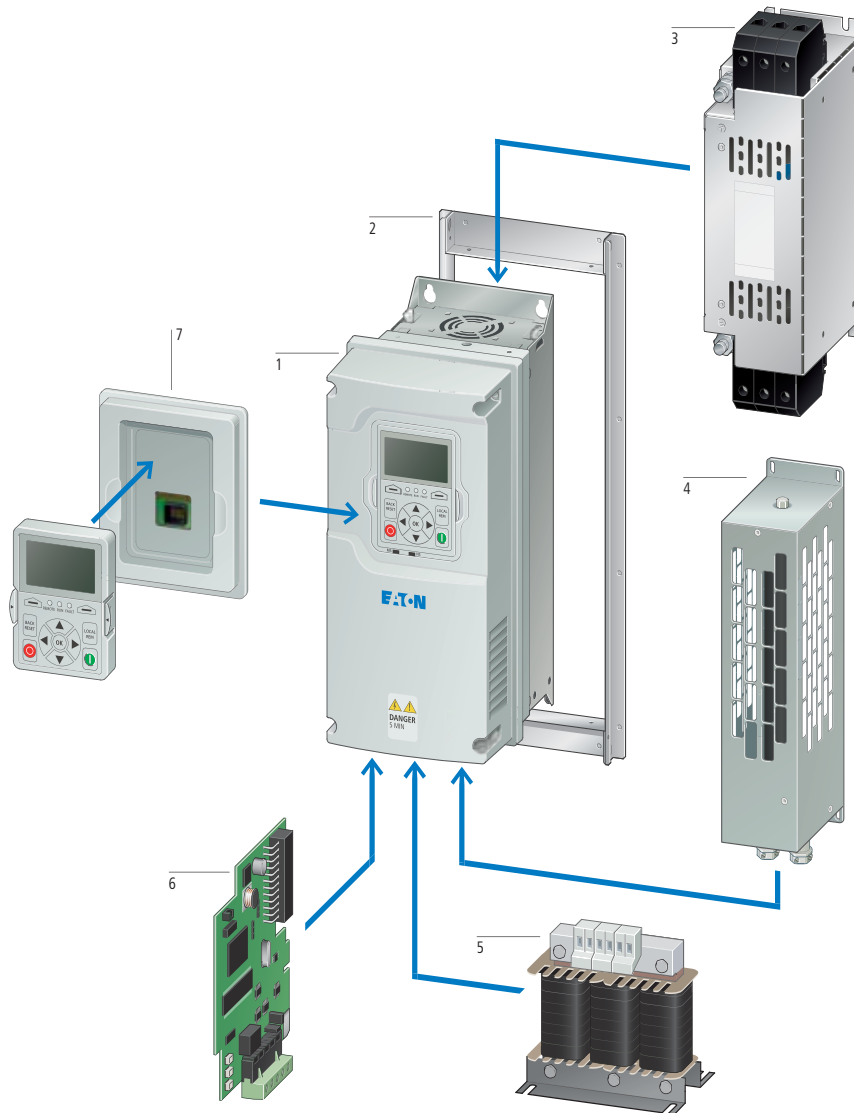

DG1 variable frequency drives 1

→ page 46

Mounting accessories 2

→ page 51

External radio interference suppression filter 3

→ page 54

Braking resistance 4

→ page 56

Mains choke, motor choke, sine filter 5

→ page 60

Expansion modules, fieldbus modul 6

→ page 50

External keypad 7

→ page 50

Key to type references

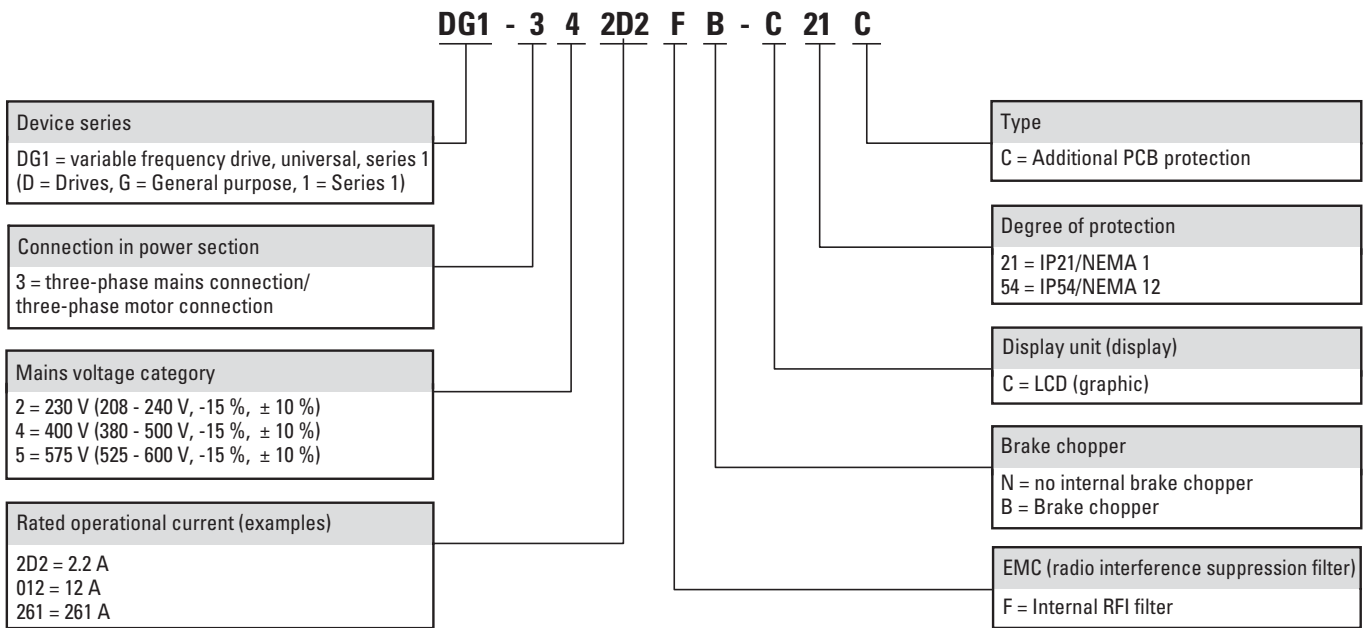

DG1

UL/CSA



Information relevant for export to North America

Product Standards	UL508C, CSA-C22.2 No. 274-13; IEC/EN61800-3; IEC/EN61800-5; CE marking
UL File No.	E134360
UL Category Control No.	NMMS, NMMS7
CSA File No.	UL report applies to both US and Canada
North America Certification	UL listed, certified by UL for use in Canada
Suitable for	Branch circuits
Max. Voltage Rating	3~ 240 V AC IEC: TN-S UL/CSA: 'Y' (Solidly Grounded Wey) 3~ 500 V AC IEC: TN-S UL/CSA: 'Y' (Solidly Grounded Wey)

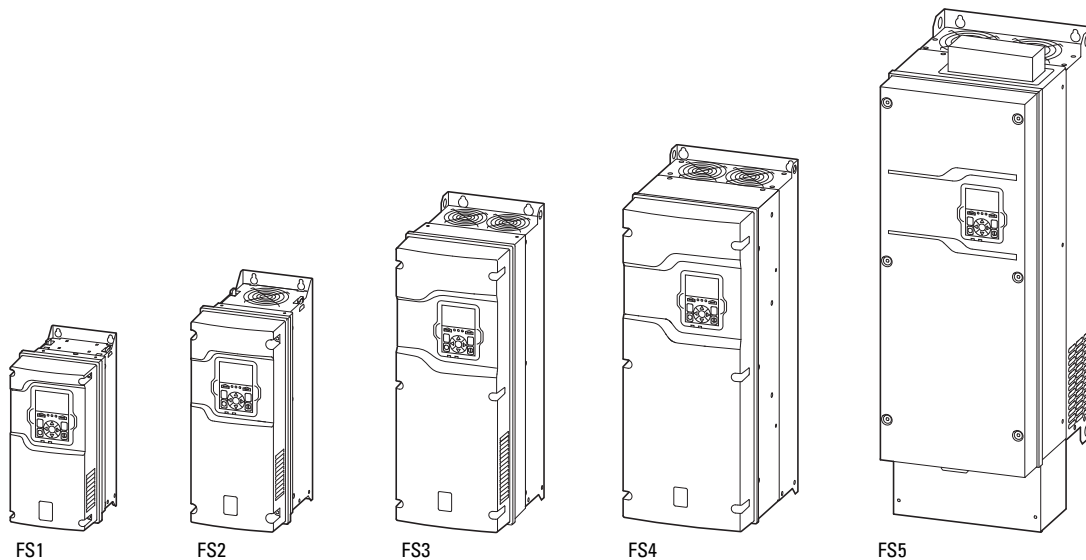
Sizes







Ordering

Rated operational current ¹⁾	Assigned motor rating ^{1), 2), 3)}		Rated operational current ¹⁾	Assigned motor rating ^{1), 2), 3)}		Fitted with					Frame size	Degree of Protection	Part no. Article no.	Price see price list	Std. pack	
$I_H = 150\%$ I_e A	$I_H = 150\%$ P kW	$I_H = 150\%$ P HP	$I_L = 110\%$ I_e A	$I_L = 110\%$ P kW	$I_L = 110\%$ P HP	Radio interference suppression filter	Brake chopper	DC link choke	Multi-line graphic display	Additional PCB protection						
U_e 230 V AC, 3-phase / U_2 230 V AC, 3-phase Mains voltage (50/60Hz) U_{LN} : 208 (-15%) - 240 (+10%) V																
3.7	0.75	0.75	4.8	1.1	1	✓	✓	✓	✓	✓	FS1	IP21/ NEMA1	DG1-323D7FB-C21C 9701-1002-00P		1 off  	
4.8	1.1	1	6.6	1.5	1.5	✓	✓	✓	✓	✓			DG1-324D8FB-C21C 9701-1004-00P			
6.6	1.5	1.5	7.8	2	2	✓	✓	✓	✓	✓			DG1-326D6FB-C21C 9701-1006-00P			
7.8		2			11	2.2	3	✓	✓	✓	✓	✓			DG1-327D8FB-C21C 9701-1008-00P	
11	2.2	3	12.5	3		✓	✓	✓	✓	✓			DG1-32011FB-C21C 9701-1001-00P			
12.5	3		17.5	4	5	✓	✓	✓	✓	✓	FS2		DG1-32012FB-C21C 9701-2002-00P			
17.5	4	5	25	5.5	7.5	✓	✓	✓	✓	✓			DG1-32017FB-C21C 9701-2004-00P			
25	5.5	7.5	31	7.5	10	✓	✓	✓	✓	✓			DG1-32025FB-C21C 9701-2001-00P			
31	7.5	10	48	11	15	✓	✓	✓	✓	✓	FS3		DG1-32031FB-C21C 9701-3002-00P			
48	11	15	61	15	20	✓	✓	✓	✓	✓			DG1-32048FB-C21C 9701-3001-00P			
61	15	20	75	22	25	✓	-	✓	✓	✓	FS4		DG1-32061FN-C21C 9701-4004-00P			
						✓	✓	✓	✓	✓			DG1-32061FB-C21C 9701-4002-00P			
75	22	25	88	22	30	✓	-	✓	✓	✓			DG1-32075FN-C21C 9701-4008-00P			
						✓	✓	✓	✓	✓			DG1-32075FB-C21C 9701-4006-00P			
88		30	114	30	40	✓	-	✓	✓	✓			DG1-32088FN-C21C 9701-4001-00P			
						✓	✓	✓	✓	✓			DG1-32088FB-C21C 9701-4010-00P			
114	30	40	143	45	50	✓	-	✓	✓	✓			DG1-32114FN-C21C 9701-5004-00P			
						✓	✓	✓	✓	✓			DG1-32114FB-C21C 9701-5002-00P			
143	45	50	170		60	✓	-	✓	✓	✓	FS5		DG1-32143FN-C21C 9701-5008-00P			
						✓	✓	✓	✓	✓			DG1-32143FB-C21C 9701-5006-00P			
170		60	211	55	75	✓	-	✓	✓	✓			DG1-32170FN-C21C 9701-5001-00P			
						✓	✓	✓	✓	✓			DG1-32170FB-C21C 9701-5010-00P			
211	55	75	261	75	100	✓	-	✓	✓	✓	FS6		DG1-32211FN-C21C 9701-6003-00P		1 Stück	
						✓	✓	✓	✓	✓			DG1-32211FB-C21C 9701-6001-00P			
248	75	90	312	90	125	✓	-	✓	✓	✓			DG1-32248FN-C21C 9701-6007-00P			
						✓	✓	✓	✓	✓			DG1-32248FB-C21C 9701-6005-00P			

Notes



- ¹⁾ Overload cycle for 60 s every 600 s
- ²⁾ for normal internally and externally ventilated 4 pole, three-phase asynchronous motors with 1500 rpm⁻¹ at 50 Hz or 1800 min⁻¹ at 60 Hz
- ³⁾ at 230 V, 50 Hz/at 230 V, 60 Hz

  Information relevant for export to North America → Page 45



Rated operational current ¹⁾	Assigned motor rating ^{1), 2), 3)}			Assigned motor rating ^{1), 2), 3)}			Fitted with					Frame size	Degree of Protection	Part no. Article no.	Price see price list	Std. pack
	I _H = 150 % I _e A	I _H = 150 % P kW	I _H = 150 % P HP	I _L = 110 % I _e A	I _L = 110 % P kW	I _L = 110 % P HP	Radio interference suppression filter	Brake chopper	DC link choke	Multi-line graphic display	Additional PCB protection					
U ₀ 400 V AC, 3-phase / U ₂ 400 V AC, 3-phase Mains voltage (50/60Hz) U _{LN} : 380 (-15%) - 500 (+10%) V																
2.2	0.75	1	3.3	1.1	1.5	✓	✓	✓	✓	✓	FS1	IP21/ NEMA1	DG1-342D2FB-C21C 9702-1002-00P	1 off  		
3.3	1.1	1.5	4.3	1.5	2	✓	✓	✓	✓	✓			DG1-343D3FB-C21C 9702-1004-00P			
4.3	1.5	2	5.6	2.2	3	✓	✓	✓	✓	✓			DG1-344D3FB-C21C 9702-1006-00P			
5.6	2.2	3	7.6	3		✓	✓	✓	✓	✓			DG1-345D6FB-C21C 9702-1008-00P			
7.6	3		9	4	5	✓	✓	✓	✓	✓			DG1-347D6FB-C21C 9702-1001-00P			
9	4	5	12	5.5	7.5	✓	✓	✓	✓	✓			DG1-349D0FB-C21C 9702-1011-00P			
12	5.5	7.5	16	7.5	10	✓	✓	✓	✓	✓			FS2		DG1-34012FB-C21C 9702-2002-00P	
16	7.5	10	23	11	15	✓	✓	✓	✓	✓					DG1-34016FB-C21C 9702-2004-00P	
23	11	15	31	15	20	✓	✓	✓	✓	✓					DG1-34023FB-C21C 9702-2001-00P	
31	15	20	38	18.5	25	✓	✓	✓	✓	✓			FS3		DG1-34031FB-C21C 9702-3002-00P	
38	18.5	25	46	22	30	✓	✓	✓	✓	✓	DG1-34038FB-C21C 9702-3004-00P					
46	22	30	61	30	40	✓	✓	✓	✓	✓	DG1-34046FB-C21C 9702-3001-00P					
61	30	40	72	37	50	✓	-	✓	✓	✓	FS4	DG1-34061FN-C21C 9702-4004-00P				
						✓	✓	✓	✓	✓		DG1-34061FB-C21C 9702-4002-00P				
72	37	50	87	45	60	✓	-	✓	✓	✓		DG1-34072FN-C21C 9702-4008-00P				
						✓	✓	✓	✓	✓		DG1-34072FB-C21C 9702-4006-00P				
87	45	60	105	55	75	✓	-	✓	✓	✓	FS5	DG1-34087FN-C21C 9702-4001-00P				
						✓	✓	✓	✓	✓		DG1-34087FB-C21C 9702-4010-00P				
105	55	75	140	75	100	✓	-	✓	✓	✓		DG1-34105FN-C21C 9702-5004-00P				
						✓	✓	✓	✓	✓	DG1-34105FB-C21C 9702-5002-00P					
140	75	100	170	90	125	✓	-	✓	✓	✓	FS6	DG1-34140FN-C21C 9702-5008-00P				
						✓	✓	✓	✓	✓		DG1-34140FB-C21C 9702-5006-00P				
170	90	125	205	110	150	✓	-	✓	✓	✓		DG1-34170FN-C21C 9702-5001-00P				
						✓	✓	✓	✓	✓	DG1-34170FB-C21C 9702-5010-00P					
205	110	150	261	132	200	✓	-	✓	✓	✓	FS6	DG1-34205FN-C21C 9702-6003-00P				
						✓	✓	✓	✓	✓		DG1-34205FB-C21C 9702-6001-00P				
245	132	200	310	160	250	✓	-	✓	✓	✓		DG1-34245FN-C21C 9702-6007-00P				
						✓	✓	✓	✓	✓	DG1-34245FB-C21C 9702-6005-00P					

Notes

- ¹⁾ Overload cycle for 60 s every 600 s
- ²⁾ for normal internally and externally ventilated 4 pole, three-phase asynchronous motors with 1500 rpm⁻¹ at 50 Hz or 1800 min⁻¹ at 60 Hz
- ³⁾ at 400 V, 50 Hz/at 480 V, 60 Hz



  Information relevant for export to North America → Page 45



DG1

Rated operational current ¹⁾	Assigned motor rating ^{1), 2), 3)}			Rated operational current ¹⁾	Assigned motor rating ^{1), 2), 3)}			Fitted with					Frame size	Degree of Protection	Part no. Article no.	Price see price list	Std. pack
	I _H = 150 % I _e A	I _H = 150 % P kW	I _H = 150 % P HP		I _L = 110 % I _e A	I _L = 110 % P kW	I _L = 110 % P HP	Radio interference suppression filter	Brake chopper	DC link choke	Multi-line graphic display	Additional PCB protection					
U _e 230 V AC, 3-phase / U ₂ 230 V AC, 3-phase Mains voltage (50/60Hz) U _{LN} : 208 (-15%) - 240 (+10%) V																	
3.7	0.75	0.75	4.8	1.1	1	✓	✓	✓	✓	✓	FS1	IP54/ NEMA12	DG1-323D7FB-C54C 9701-1101-00P	1 off  			
4.8	1.1	1	6.6	1.5	1.5	✓	✓	✓	✓	✓	FS1		DG1-324D8FB-C54C 9701-1103-00P				
6.6	1.5	1.5	7.8	2	2	✓	✓	✓	✓	✓			DG1-326D6FB-C54C 9701-1105-00P				
7.8	1.5	2	11	2.2	3	✓	✓	✓	✓	✓	FS1		DG1-327D8FB-C54C 9701-1107-00P				
11	2.2	3	12.5	3	3	✓	✓	✓	✓	✓			DG1-32011FB-C54C 9701-1109-00P				
12.5	3		17.5	4	5	✓	✓	✓	✓	✓	FS2		DG1-32012FB-C54C 9701-2101-00P				
17.5	4	5	25	5.5	7.5	✓	✓	✓	✓	✓	FS2		DG1-32017FB-C54C 9701-2103-00P				
25	5.5	7.5	31	7.5	10	✓	✓	✓	✓	✓			DG1-32025FB-C54C 9701-2105-00P				
31	7.5	10	48	11	15	✓	✓	✓	✓	✓	FS3		DG1-32031FB-C54C 9701-3101-00P				
48	11	15	61	15	20	✓	✓	✓	✓	✓	FS3		DG1-32048FB-C54C 9701-3103-00P				
61	15	20	75	22	25	✓	-	✓	✓	✓			FS4		DG1-32061FN-C54C 9701-4103-00P		
75	22	25	88		30	✓	-	✓	✓	✓	FS4		DG1-32075FN-C54C 9701-4107-00P				
88		30	114	30	40	✓	-	✓	✓	✓			DG1-32075FB-C54C 9701-4105-00P				
88		30	114	30	40	✓	-	✓	✓	✓	FS4		DG1-32088FN-C54C 9701-4111-00P				
114	30	40	143	45	50	✓	-	✓	✓	✓			DG1-32088FB-C54C 9701-4109-00P				
143	45	50	170		60	✓	-	✓	✓	✓	FS5		DG1-32114FN-C54C 9701-5103-00P				
170		60	211	55	75	✓	-	✓	✓	✓	FS5		DG1-32114FB-C54C 9701-5101-00P				
211	55	75	261	75	100	✓	-	✓	✓	✓			FS6		DG1-32143FN-C54C 9701-5107-00P		
261	75	90	312	90	125	✓	-	✓	✓	✓	FS6	DG1-32143FB-C54C 9701-5105-00P					
312	90	125				✓	-	✓	✓	✓		DG1-32170FN-C54C 9701-5111-00P					
312	90	125				✓	-	✓	✓	✓	FS6	DG1-32170FB-C54C 9701-5109-00P					
312	90	125				✓	-	✓	✓	✓		DG1-32211FN-C54C 9701-6103-00P					
312	90	125				✓	-	✓	✓	✓	FS6	DG1-32211FB-C54C 9701-6101-00P					
312	90	125				✓	-	✓	✓	✓		DG1-32248FN-C54C 9701-6107-00P					
312	90	125				✓	-	✓	✓	✓	FS6	DG1-32248FB-C54C 9701-6105-00P					

Notes

- ¹⁾ Overload cycle for 60 s every 600 s
- ²⁾ for normal internally and externally ventilated 4 pole, three-phase asynchronous motors with 1500 rpm⁻¹ at 50 Hz or 1800 min⁻¹ at 60 Hz
- ³⁾ at 230 V, 50 Hz/at 230 V, 60 Hz

  Information relevant for export to North America → Page 45



Rated operational current ¹⁾	Assigned motor rating ^{1), 2), 3)}		Rated operational current ¹⁾	Assigned motor rating ^{1), 2), 3)}		Fitted with					Frame size	Degree of Protection	Part no. Article no.	Price see price list	Std. pack
	$I_H = 150\%$ I_e A	$I_H = 150\%$ P kW		$I_H = 150\%$ P HP	$I_L = 110\%$ I_e A	$I_L = 110\%$ P kW	$I_L = 110\%$ P HP	Radio interference suppression filter	Brake chopper	DC link choke					
U_e 400 V AC, 3-phase / U_e 400 V AC, 3-phase Mains voltage (50/60Hz) U_{LN} : 380 (-15%) - 500 (+10%) V															
2.2	0.75	1	3.3	1.1	1.5	✓	✓	✓	✓	✓	FS1	IP54/ NEMA12	DG1-342D2FB-C54C 9702-1101-00P	1 off  	
3.3	1.1	1.5	4.3	1.5	2	✓	✓	✓	✓	✓			DG1-343D3FB-C54C 9702-1103-00P		
4.3	1.5	2	5.6	2.2	3	✓	✓	✓	✓	✓			DG1-344D3FB-C54C 9702-1105-00P		
5.6	2.2	3	7.6	3		✓	✓	✓	✓	✓			DG1-345D6FB-C54C 9702-1107-00P		
7.6	3		9	4	5	✓	✓	✓	✓	✓			DG1-347D6FB-C54C 9702-1109-00P		
9	4	5	12	5.5	7.5	✓	✓	✓	✓	✓			DG1-349D0FB-C54C 9702-1111-00P		
12	5.5	7.5	16	7.5	10	✓	✓	✓	✓	✓			FS2		DG1-34012FB-C54C 9702-2101-00P
16	7.5	10	23	11	15	✓	✓	✓	✓	✓					DG1-34016FB-C54C 9702-2103-00P
23	11	15	31	15	20	✓	✓	✓	✓	✓					DG1-34023FB-C54C 9702-2105-00P
31	15	20	38	18.5	25	✓	✓	✓	✓	✓			FS3		DG1-34031FB-C54C 9702-3101-00P
38	18.5	25	46	22	30	✓	✓	✓	✓	✓					DG1-34038FB-C54C 9702-3103-00P
46	22	30	61	30	40	✓	✓	✓	✓	✓			FS4		DG1-34046FB-C54C 9702-3105-00P
61	30	40	72	37	50	✓	✓	✓	✓	✓	DG1-34061FB-C54C 9702-4101-00P				
						✓	-	✓	✓	✓	DG1-34061FN-C54C 9702-4103-00P				
72	37	50	87	45	60	✓	-	✓	✓	✓	DG1-34072FN-C54C 9702-4107-00P				
						✓	✓	✓	✓	✓	DG1-34072FB-C54C 9702-4105-00P				
87	45	60	105	55	75	✓	-	✓	✓	✓	DG1-34087FN-C54C 9702-4111-00P				
						✓	✓	✓	✓	✓	DG1-34087FB-C54C 9702-4109-00P				
105	55	75	140	75	100	✓	-	✓	✓	✓	FS5	DG1-34105FN-C54C 9702-5103-00P			
						✓	✓	✓	✓	✓		DG1-34105FB-C54C 9702-5101-00P			
140	75	100	170	90	125	✓	-	✓	✓	✓		DG1-34140FN-C54C 9702-5107-00P			
						✓	✓	✓	✓	✓	DG1-34140FB-C54C 9702-5105-00P				
170	90	125	205	110	150	✓	-	✓	✓	✓	FS6	DG1-34170FN-C54C 9702-5111-00P			
						✓	✓	✓	✓	✓		DG1-34170FB-C54C 9702-5109-00P			
205	110	150	261	132	200	✓	-	✓	✓	✓	DG1-34205FN-C54C 9702-6103-00P				
						✓	✓	✓	✓	✓	DG1-34205FB-C54C 9702-6101-00P				
245	132	200	310	160	250	✓	-	✓	✓	✓	FS6	DG1-34245FN-C54C 9702-6107-00P			
						✓	✓	✓	✓	✓		DG1-34245FB-C54C 9702-6105-00P			

Notes

¹⁾ Overload cycle for 60 s every 600 s

²⁾ for normal internally and externally ventilated 4 pole, three-phase asynchronous motors with 1500 rpm⁻¹ at 50 Hz or 1800 min⁻¹ at 60 Hz

³⁾ at 400 V, 50 Hz/at 480 V, 60 Hz

  Information relevant for export to North America → Page 45

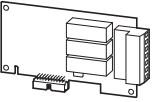
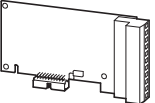
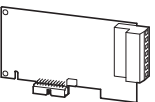
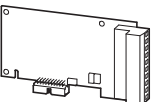
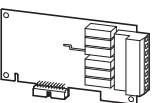
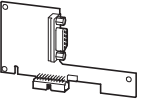
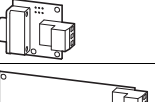
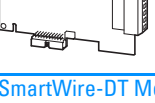
	Description	Length m	For use with	Part no. Article no.	Price see price list	Std. pack
External keypad						
	with LCD display Front IP54 Multilingual	-	DG1	DXG-KEY-LCD 730-32047-00P		1 off
	Mounting frame with approx. 3 m-long, plug-in connection cable	3	DXG-KEY-LCD	DXG-KEY-RMTKIT 730-32033-00P		
	Mounting frame	-		DXG-KEY-HOLDER 730-32032-00P		
	Cover for RJ45 interface	-		DXG-KEY-N12PLUG 730-32038-00P		
Expansion modules						
	Output expansion 3 relay outputs	-	DG1	DXG-EXT-3RO 744-A2614-00P		1 off
	I/O expansion 3 digital inputs 3 Digital outputs 1 Thermistor input	-	DG1	DXG-EXT-3DI3DO1T 744-A2612-00P		
	I/O expansion 1 Analog input 2 Analog outputs	-	DG1	DXG-EXT-1AI2AO 744-A2613-00P		
	Input expansion Thermistor input	-	DG1	DXG-EXT-THER1 744-A2615-00P		
	Input expansion 240-V-AC input (electrically isolated) for 6 digital inputs	-	DG1	DXG-EXT-6DI 744-A2616-00P		
Fieldbus modules						
	PROFIBUS-DP SUB-D socket, 9-pole	-	DG1	DXG-NET-PROFIBUS 744-A2617-00P		1 off
	Interface converter from 9-pin SUB-D plug to 3-pin control signal terminal	-	DXG-NET-PROFIBUS	DXG-MNT-PROFIBUS 744-A2618-00P		
	CANopen® Terminal strip, 5-terminal	-	DG1	DXG-NET-CANOPEN 744-F0116-00P		
	DeviceNet Terminal strip, 5-terminal	-	DG1	DXG-NET-DEVICENET 744-F0117-00P		
SmartWire-DT Module						
	SmartWire-DT 2 x M12 IP21/NEMA1	-	DG1	DXG-NET-SWD-IP20 744-F0190-00P		1 Stück
	SmartWire-DT 2 x M12 IP54/NEMA12	-	DG1	DXG-NET-SWD-IP54 744-F0191-00P		

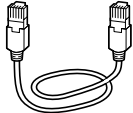
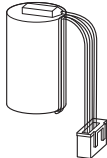
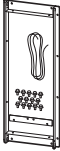
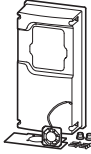
Description	Length m	For use with	Part no. Article no.	Price see price list	Std. pack
PC communication					
parameter software	-	DG1	DXG-ACC-SOFTWARE 730-32036-00P		1 off
					
connection cable					
	Patch cord with RJ45 plugs, 8 pole	1	DG1	DXG-CBL-1M0 730-32034-00P	1 off
		3		DXG-CBL-3M0 730-32035-00P	
Interface converter	RJ45/USB, with CD	-	DG1	DXG-CBL-PCCABLE 730-32037-00P	
Demo case and simulator					
-	DG1 simulator (control section)	-	-	DG1-DEMO1 178125	1 off
-	DG1 simulator	-	-	DG1-DEMO2-230 178126	
Battery					
	Battery for real-time clock	-	-	DXG-ACC-RTBATT 730-32039-00P	1 off
mounting accessories					
mounting frame For the power section's push-through installation outside the control panel					
	Frame parts and fixing screws	-	DG1 (frame size FS1)	DXG-ACC-FR1N12FK 730-32022-00P	1 off
		-	DG1 (frame size FS2)	DXG-ACC-FR2N12FK 730-32023-00P	
		-	DG1 (frame size FS3)	DXG-ACC-FR3N12FK 730-32024-00P	
		-	DG1 (frame size FS4)	DXG-ACC-FR4N12FK 730-32025-00P	
		-	DG1 (frame size FS5)	DXG-ACC-FR5N12FK 730-32026-00P	
Mounting set For increasing the degree of protection from IP21/NEMA 1 to IP54/NEMA 12					
	Enclosure cover with seals and extra fan	-	DG1-34... (frame size FS1, 400/480 V)	DXG-ACC-4FR1N12KIT 730-32029-00P	
		-	DG1 (frame size FS2)	DXG-ACC-FR2N12KIT 730-32030-00P	
		-	DG1 (frame size FS3)	DXG-ACC-FR3N12KIT 730-32031-00P	
		-	DG1-32... (frame size FS1, 230 V)	DXG-ACC-2FR1N12KIT 744-A2815-00P	



Accessories and Engineering

With PowerXL variable speed starters and PowerXL and 9000X variable frequency drives, you can rest assured knowing that your variable-speed power drive system (PDS) needs will be well taken care of. These units are known for their compact design and wide applicability, making them the ideal choice for most applications on the global market.

But that's not all: Additional options such as mains chokes, motor chokes, sine filters, and braking resistors make it possible not only to expand the devices' range of applications, but also to adapt to a variety of EMC environments and mains-side operating conditions.

DX-LN... mains chokes

DX-LN1...: single phase, max. 260 V, 50/60 Hz, 6 - 32 A

DX-LN3...: 3-phase max. 550 V, 50/60 Hz, 4 - 450 A

Motor choke DX-LM3...

DX-LM3...: 3-phase, max. 750 V, 0 - 400 Hz, 5 - 450 A

Radio interference suppression filter DX-EMC...

Calibrated and assigned radio interference suppression filter for Series DA1, DC1 and DL1

DX-EMC12...: single phase, with prefabricated connection cables, base-mounted filter

DX-EMC34...: 3-phase, with prefabricated connection cables, base-mounted filter, low leakage current

DX-EMC34...: 3-phase, 100 – 750 A, low leakage current

Sine filter DX-SIN3...

DX-SIN3...: 3-phase, 0 – 520 V, 0 - 150 Hz, 4 - 480 A

Sine filters used with variable frequency drives require the frequency to be set to a fixed value within a range of 4 – 8 kHz.

DX-BR... braking resistance

- with prefabricated connection cables for installation in DA1, DC1, and DL1 devices

- with 1-m long connection cable, temperature monitoring switch, 75 – 400 ohms, 0.4 – 1.6 kW

- with temperature monitoring switch, 2 – 100 Ohm, 0.2 – 102.4 kW







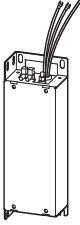
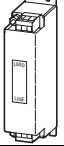
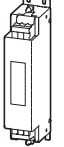

Ordering

Radio interference suppression filters	54
Braking resistances	56
Mains chokes	60
Motor chokes	60
Sine filter	61

Engineering

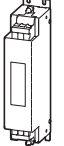
Components of the Power Drives Systems (PDS)	62
General information on Engineering	63
Connection examples	65
Assigned switching and protective elements	66

	Connection type	Rated operational current I_e A	For use with ¹⁾	Degree of Protection	Part no. Article no.	Price see price list	Std. pack	
Radio interference suppression filters								
Base-mounted filter, side-mounting filter								
	Single-phase, Mains voltage (50/60Hz) U_{LN} [V] max. 250 + 10%	Connection terminal, PE stud, prefabricated cables	14	DC1	IP00 IP20 when connected	DX-EMC12-014-FS1 172273		1 off
			14	DC1, DA1				
			19	DE1, DE11				
			25	DE1, DE11, DC1				
			31	DC1				
			31	DC1				
Separate mounting								
  	three-phase, Mains voltage (50/60Hz) U_{LN} [V] max. 520 + 10%	Screw terminal, PE stud	8	DE1, DE11, DC1, DA1, DG1	IP20	DX-EMC34-008 184500		1 off  
			16	DE1, DE11, DC1, DA1, DG1				
			30	DC1, DA1, DG1				
			42	DC1, DA1, DG1				
			55	DC1, DA1, DG1				
			75	DA1, DG1				
			100	DA1				
			130					
			180					
			250					
			250					
			250					
			250					
			  	low leakage current				
16	DE1, DE11, DC1, DA1, DG1							
30	DC1, DA1, DG1							
42	DC1, DA1, DG1							
55	DC1, DA1, DG1							
75	DA1, DG1							
100	DA1							
130								
180								
250								
250								
250								
250								

Notes¹⁾ See assigned switching and protective elements for an article-specific selection**Information relevant for export to North America**

Product Standards UL 1283



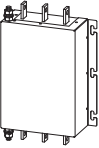

UL File No. E192040

North America Certification UL listed, certified by UL for use in Canada

Connection type		Rated operational current	For use with ¹⁾	Degree of Protection	Part no. Article no.	Price see price list	Std. pack
		I _e A					
Radio interference suppression filters							
Separate mounting							
	three-phase, Mains voltage (50/60Hz) U _{LN} [V] max. 520 + 10%						
	Flat copper bar, PE stud	400	DA1	IP00	DX-EMC34-400 172289		1 off
		750			DX-EMC34-750 177636		
	low leakage current	400			DX-EMC34-400-L 174615		
		750			DX-EMC34-750-L 177637		

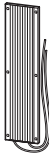
Notes

¹⁾ See assigned switching and protective elements for an article-specific selection

	Resistance value	Continuous braking rating	Degree of Protection	For use with ¹⁾	Part no. Article no.	Price see price list	Std. pack
	R Ω	P _{DB} kW					
Braking resistances							
Wire wound resistor in aluminum case for direct installation in frequency inverter enclosure of frame sizes FS2 and FS3 With prefabricated connection cable							
	100	0.2	IP54	DC1, DA1, DL1	DX-BR3-100 169150		1 off
Wire wound resistor in ceramic potting compound inside aluminum case for direct installation in frequency inverter enclosure of frame sizes FS4 and FS5							
	33	0.5	IP54	DA1	DX-BR5-033 169151		1 off
Wire wound resistor in ceramic potting compound inside aluminum case with temperature monitoring switch with connection cables (approx. 0.5 m long)							
	27	0.24	IP65	DC1, DA1, DG1, SVX, SPX	DX-BR027-240 174243		1 off  
	40	0.2			DX-BR040-200 174242		
	47	0.24			DX-BR047-240 174236		
	50	0.2			DX-BR050-200 174235		
	100	0.1			DX-BR100-100 174241		
	100	0.2			DX-BR100-200 174237		
	100	0.24			DX-BR100-240 174238		
	150	0.2			DX-BR150-200 174248		
	210	0.2			DX-BR210-200 174247		
	430	0.1			DX-BR430-100 174246		

Notes

¹⁾ See assigned switching and protective elements for an article-specific selection



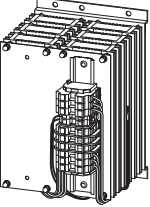

Information relevant for export to North America

Product Standards	UL508; C22.2
UL File No.	E300273
UL Category Control No.	NMTR2, NMTR8
CSA File No.	UL report applies to both US and Canada
North America Certification	UL listed, certified by UL for use in Canada
Suitable for	Branch circuits
Max. Voltage Rating	1000
Degree of Protection	IEC: IP00

	Resistance value	Continuous braking rating	Degree of Protection	For use with ¹⁾	Part no. Article no.	Price see price list	Std. pack
	R Ω	P _{DB} kW					
Braking resistances							
Resistor combination (size 1) with temperature monitoring switch with connection terminals							
	20	0.96	IP20	DC1, DA1, DG1, SVX, SPX	DX-BR020-960 174257		1 off
	24	0.4			DX-BR024-400 174244		
	24	0.6			DX-BR024-600 174267		
	24	0.72			DX-BR024-720 174245		
	42	0.72			DX-BR042-720 174266		
	50	0.4			DX-BR050-400 174239		
	50	0.6			DX-BR050-600 174240		
	50	0.72			DX-BR050-720 174265		
	50	0.96			DX-BR050-960 174250		
	75	0.4			DX-BR075-400 174249		
	100	0.6			DX-BR100-600 174251		
	100	0.72			DX-BR100-720 174252		
	100	0.96			DX-BR100-960 174253		
	150	0.8			DX-BR150-800 174262		
	216	0.6			DX-BR216-600 174268		
400	0.4	DX-BR400-400 174261					
Resistor combination (size 2) with temperature monitoring switch with connection terminals							
	25	1.44	IP20	DC1, DA1, DG1, SVX, SPX	DX-BR025-1440 174258		1 off
	25	1.92			DX-BR025-1920 174259		
	27	2.88			DX-BR027-2880 174260		
	50	1.44			DX-BR050-1440 174254		
	50	1.92			DX-BR050-1920 174255		
	50	2.88			DX-BR050-2880 174264		
	54	2.88			DX-BR054-2880 174256		
	84	1.44			DX-BR084-1440 174263		

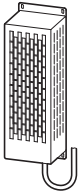

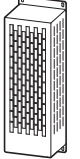
Notes

¹⁾ See assigned switching and protective elements for an article-specific selection

	Resistance value	Continuous braking rating	Degree of Protection	For use with ¹⁾	Part no. Article no.	Price see price list	Std. pack
	R Ω	P _{DB} kW					
Braking resistances							
Wire wound resistor in ceramic potting compound inside aluminum case, combined installed in a housing designed to prevent accidental contact and featuring a temperature monitoring switch and a 1-meter connection cable							
	75	1.1	IP20	DA1, DL1, DG1, SVX, SPX	DX-BR075-1K1 171917		1 off  
	100	0.8	IP20		DX-BR100-0K8 171907		
	100	1.1	IP20		DX-BR100-1K1 171896		
	100	1.6	IP20		DX-BR100-1K6 171924		
	150	0.5	IP20		DX-BR150-0K5 171916		
	150	1.1	IP20		DX-BR150-1K1 171895		
	200	0.4	IP20		DX-BR200-0K4 171915		
	200	0.8	IP20		DX-BR200-0K8 171894		
	400	0.4	IP20		DX-BR400-0K4 171914		
Wire wound resistor in ceramic potting compound inside aluminum case, combined installed in a housing designed to prevent accidental contact and featuring a temperature monitoring switch and internal connecting terminals							
	35	1.1	IP20	DA1, DL1, DG1, SVX, SPX	DX-BR035-1K1 171927		1 off  
	50	0.4	IP20		DX-BR050-0K4 171906		
	50	0.8	IP20		DX-BR050-0K8 171910		
	100	0.2	IP20		DX-BR100-0K2 171909		
	100	0.4	IP20		DX-BR100-0K4 171926		

Notes¹⁾ See assigned switching and protective elements for an article-specific selection**Information relevant for export to North America**

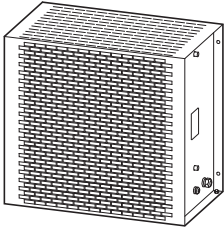
Product Standards	UL508; C22.2
UL File No.	E300273
UL Category Control No.	NMTR2, NMTR8
CSA File No.	UL report applies to both US and Canada
North America Certification	UL listed, certified by UL for use in Canada
Suitable for	Branch circuits
Max. Voltage Rating	600
Degree of Protection	IEC: IP00

Resistance value	Continuous braking rating	Degree of Protection	For use with ¹⁾	Part no. Article no.	Price see price list	Std. pack
R	P _{DB}					
Ω	kW					
Braking resistances						
Steel grid resistor, combined Installed in a housing designed to prevent accidental contact and featuring a temperature monitoring switch and internal connection terminals/terminal bolts						
	2	54.3	IP20	DC1, DA1, DL1, DG1, SVX, SPX	DX-BR002-54K3	1 off  
		102.4			171923	
	6	5.1			DX-BR002-102K4	
		9.2			171903	
		18.1			DX-BR006-5K1	
		33.3			171913	
		DX-BR006-9K2				
	12	3.1			171893	
		5.1			DX-BR006-18K1	
		9.2			171922	
		18.1			DX-BR006-33K3	
	22	1.4			171902	
		3.1			DX-BR012-3K1	
		5.1			171912	
		9.2			DX-BR012-5K1	
		18.1			171929	
	40	1.4			DX-BR012-9K2	
		3.1			171921	
		5.1			DX-BR012-18K1	
		9.2			171901	
	47	1.4			DX-BR022-1K4	
		3.1			171911	
		5.1			DX-BR022-3K1	
		9.2			171928	
50	3.1	DX-BR022-5K1				
	5.1	171920				
	9.2	DX-BR022-9K2				
75	3.1	171900				
	5.1	DX-BR040-3K1				
	6.2	171919				
100	3.1	DX-BR040-5K1				
	5.1	171899				
	6.2	DX-BR047-3K1				
100	3.1	171908				
	5.1	DX-BR047-5K1				
	6.2	171925				
100	3.1	DX-BR047-9K2				
	5.1	171905				
	6.2	DX-BR050-3K1				
100	3.1	171918				
	5.1	DX-BR050-5K1				
	6.2	171898				
100	3.1	DX-BR075-5K1				
	5.1	171897				
	6.2	DX-BR100-6K2				
100	3.1	171904				





Notes



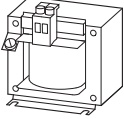
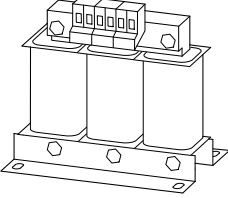

¹⁾ See assigned switching and protective elements for an article-specific selection

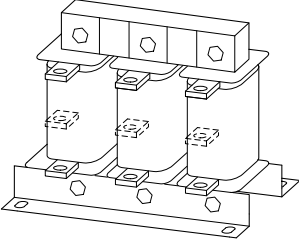
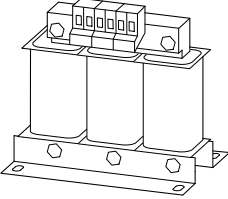
Information relevant for export to North America

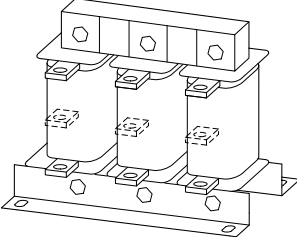

Product Standards	UL508; C22.2
UL File No.	E300273
UL Category Control No.	NMTR2, NMTR8
CSA File No.	UL report applies to both US and Canada
North America Certification	UL listed, certified by UL for use in Canada
Suitable for	Branch circuits
Max. Voltage Rating	1000
Degree of Protection	IEC: IP00

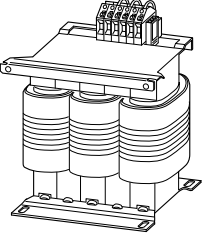
	Rated operational current I_e A	Inductance L mH	Maximum heat dissipation P_v W	For use with	Part no. Article no.	Price see price list	Std. pack		
Mains chokes									
Ambient air temperature: + 40 °C, max. 70 °C with derating									
Single-phase									
Max. permissible connection voltage V AC: 260 V + 0% (50/60 Hz)									
	5.8	5.05	9	DE1, DE11, DC1	DX-LN1-006 269490		1 off		
	8.6	3.41	11	DE1, DE11, DC1	DX-LN1-009 269495				
	13	2.25	12	DE1, DE11, DC1, DA1	DX-LN1-013 269496				
	18	1.63	17	DE1, DE11, DC1, DA1	DX-LN1-018 269497				
	24	1.22	20	DE1, DE11, DC1, DA1	DX-LN1-024 269498				
	32	0.92	24	DC1	DX-LN1-032 169791				
three-phase									
Max. permissible connection voltage V AC: 550 V + 0% (50/60 Hz)									
	3.9	7.51	17	DE1, DE11, DC1, DA1, SVX, SPX	DX-LN3-004 269500		1 off  		
	6	4.9	19	DE1, DE11, DC1, DA1, SVX, SPX	DX-LN3-006 269501				
	10	2.94	33	DE1, DE11, DC1, DA1, SVX, SPX	DX-LN3-010 269502				
	16	1.84	44	DE1, DE11, DC1, DA1, SVX, SPX	DX-LN3-016 269503				
	25	1.18	57	DC1, DA1, SVX, SPX	DX-LN3-025 269504				
	40	0.64	59	DA1, SVX, SPX	DX-LN3-040 269505				
	50	0.37	58	DA1, SVX, SPX	DX-LN3-050 269506				
	60	0.31	60	DA1, SVX, SPX	DX-LN3-060 269507				
	80	0.23	86	DA1, SVX, SPX	DX-LN3-080 269508				
	100	0.18	101	DA1, SVX, SPX	DX-LN3-100 269509				
	120	0.15	100	DA1, SVX, SPX	DX-LN3-120 269510				
	160	0.11	140	DA1, SVX, SPX	DX-LN3-160 269511				
	200	0.09	154	DA1, SVX, SPX	DX-LN3-200 269512				
	250	0.07	155	DA1, SVX, SPX	DX-LN3-250 269513				
	300	0.06	196	DA1, SVX, SPX	DX-LN3-300 269514				
	303	0.06	230	DA1, SVX, SPX	DX-LN3-303 169143				
	370	0.05	290	DA1	DX-LN3-370 169144				
	450	0.04	300	DA1	DX-LN3-450 169145				
	Motor chokes								
	Ambient air temperature: + 40 °C, max. 70 °C with derating								
three-phase									
Max. permissible connection voltage V AC: 750 V + 0% (0 - 400 Hz)									
Max. permissible pulse frequency: $f_{PWM} \leq 12$ kHz (rms)									
	5	2	24	DE1, DE11, DC1, DA1, DG1, SVX, SPX	DX-LM3-005 269538		1 off  		
	8	4.1	54	DE1, DE11, DC1, DA1, DG1, SVX, SPX	DX-LM3-008 269539				
	11	3	71	DE1, DE11, DC1, DA1, DG1, SVX, SPX	DX-LM3-011 269541				
	16	1.5	78	DE1, DE11, DC1, DA1, DG1, SVX, SPX	DX-LM3-016 269542				
	35	1	116	DC1, DA1, DL1, DG1, SVX, SPX	DX-LM3-035 269543				
	50	0.6	168	DA1, DL1, DG1, SVX, SPX	DX-LM3-050 269544				

	Rated operational current I_e A	Inductance L mH	Maximum heat dissipation P_v W	For use with	Part no. Article no.	Price see price list	Std. pack	
Motor chokes								
Ambient air temperature: + 40 °C, max. 70 °C with derating								
three-phase								
Max. permissible connection voltage V AC: 750 V + 0% (0 - 400 Hz)								
Max. permissible pulse frequency: $f_{PWM} \leq 12$ kHz (rms)								
	63	0.5	193	DA1, DL1, DG1, SVX, SPX	DX-LM3-063 269545		1 off 	
	80	0.5	206	DA1, DL1, DG1, SVX, SPX	DX-LM3-080 269546			
	100	0.45	294	DA1, DG1, SVX, SPX	DX-LM3-100 269547			
	150	0.35	424	DA1, DG1, SVX, SPX	DX-LM3-150 269548			
	180	0.3	439	DA1, DG1, SVX, SPX	DX-LM3-180 269549			
	220	0.2	517	DA1, SVX, SPX	DX-LM3-220 269560			
	260	0.15	520	DA1, SVX, SPX	DX-LM3-260 269561			
	303	0.15	-	DA1, SPX	DX-LM3-303 169146			
	370	0.12	-	DA1	DX-LM3-370 169147			
	450	0.1	-	DA1, SPX	DX-LM3-450 169148			
Sine filter								
Ambient air temperature: + 40 °C, max. 50 °C with derating								
three-phase								
Max. permissible connection voltage V AC: 500 V + 0% (50/60 Hz)								
Max. permissible pulse frequency: $f_{PWM} = \text{Constant } 4 - 8$ kHz (rms).								
	4	11	50	DC1, DA1, DG1, SVX, SPX	DX-SIN3-004 271538		1 off 	
	10	5.1	100	DC1, DA1, DL1, DG1, SVX, SPX	DX-SIN3-010 271590			
	16.5	3.07	70	DC1, DA1, DL1, DG1, SVX, SPX	DX-SIN3-016 271591			
	23.5	2.5	125	DC1, DA1, DL1, DG1, SVX, SPX	DX-SIN3-023 271593			
	32	2	100	DA1, DL1, DG1, SVX, SPX	DX-SIN3-032 271594			
	37	1.7	100	DG1	DX-SIN3-037 271595			
	48	1.2	240	DA1, DL1, DG1, SVX, SPX	DX-SIN3-048 271597			
	61	1	280	DA1, SVX, SPX	DX-SIN3-061 271599			
	72	0.95	300	DA1, DG1, SVX, SPX	DX-SIN3-072 271600			
	90	0.8	290	DA1, DL1, DG1, SVX, SPX	DX-SIN3-090 271601			
	115	0	460	DA1, DG1, SVX, SPX	DX-SIN3-115 271602			
	150	0.5	530	DA1, DG1, SVX, SPX	DX-SIN3-150 271603			
	180	0.4	500	DA1, DG1, SVX, SPX	DX-SIN3-180 271604			
	250	0.35	550	DA1, SVX, SPX	DX-SIN3-250 271605			
	440	0.14	650	DA1, SPX	DX-SIN3-440 271606			1 off
	480	0.14	1550	DA1	DX-SIN3-480 169149			1 off

Instructions

 Information relevant for export to North America	
Product Standards	UL 508C; CSA-C22.2 No. 14; IEC/EN61800-3; IEC/EN61800-5; CE marking
UL File No.	DX-LN3.../DX-LM3...: E167225 DX-SIN...: E300273
UL Category Control No.	DX-LN3.../DX-LM3...: XPTQ2, XPTQ8 DX-SIN...: NMTR2, NMTR8
CSA File No.	UL report applies to both US and Canada
North America Certification Suitable for	UL listed, certified by UL for use in Canada Branch circuits
Max. Voltage Rating	1~ 240 V AC IEC: TN-S UL/CSA: "Y" (Solidly Grounded Wey), 3~ 240 V AC IEC: TN-S UL/CSA: "Y"

Accessories and Engineering

Engineering

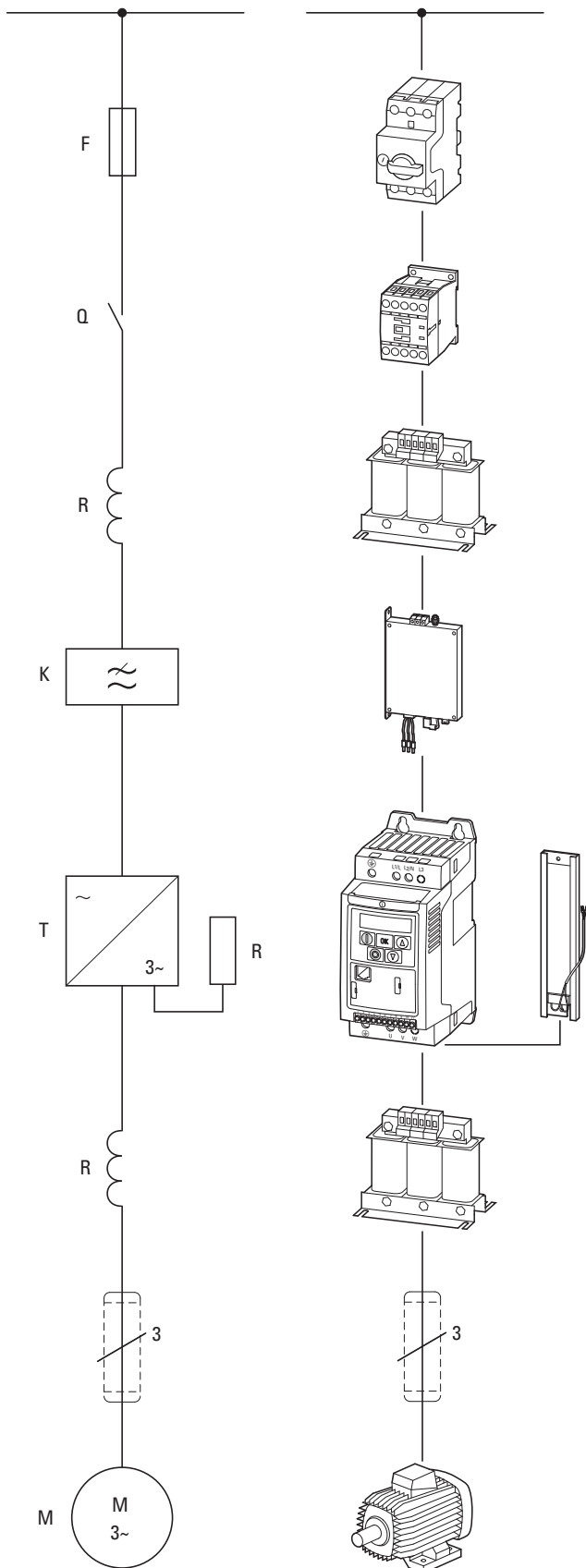

Equipment code

- F = fuses and circuit-breakers
- Q = controlled switching within energy flow (contactors, circuit-breakers)
- R = limitation (reactors, resistors)
- K = radio interference suppression filters
- T = variable-frequency drives
- M = motors

AC supply system: variable-frequency drives can be connected without restriction to AC supply systems with an earthed star point (TN/TT grounding systems). Directly connecting them to and running them on unbalanced or B phase-grounded systems (e.g., USA) is not permissible.

Fuses (circuit-breakers) enable you to protect wiring and electrical devices and appliances. For personal protection, additional AC/DC sensitive residual current circuit-breakers (RCD type B) are required.

Contactors serve to engage and disengage mains voltage.

Mains chokes damp any harmonic distortion (THD) that occurs as well as current spikes and limit inrush currents (the link capacitor's charging current). In addition, they protect the mains rectifier from voltage peaks coming from the supply mains.

Radio interference suppression filters damp high-frequency electromagnetic emissions from devices and appliances. They ensure that the EMC limit values for conducted interference specified in the applicable product standards are complied with (variable-frequency drives).

Note: External radio interference suppression filters (option) permit longer motor cables and have low leakage currents. Normally, they should only be used with variable-frequency drives that do not feature an internal radio interference suppression filter. Exception: directly assigned variable-frequency drives with internal filters (calibrated combination)

Variable frequency drives permit the infinitely variable speed control of three-phase motors. To do this, the variable-frequency drive converts the voltage of the AC supply system with a constant voltage and a constant frequency to a new AC voltage with a variable amplitude and a variable frequency.

A **braking resistance** converts the generator braking energy of the variable frequency drive into heat. The variable frequency drive must be equipped with a brake chopper, which connects the braking resistance parallel to the internal DC link.

Motor chokes

- Compensate the capacitive currents,
- Reduce current ripple and the motor's current change noise,
- Attenuate the retroaction on parallel connection of several motors.

Sine filter

- Smoothen the output voltage sinusoidally,
- reduce motor noise through du/dt reduction, and thereby increase the motor insulation's lifespan,
- Reduce the leakage currents to allow better motor performance at improved EMC values.

Screened motor cables attenuate emitted and conducted high-frequency emissions within the limit values specified in the applicable product standard (EMC). They must be connected to the earth potential on both sides across a large area (PES).

A **three-phase asynchronous motor (standard motor)** converts electrical power ($P \sim U \times I$) into mechanical power ($P \sim M \times n$).

Electrical mains connection

Variable frequency drives can be connected and operated without restriction on star-point-grounded AC supply systems (according to IEC 60364).

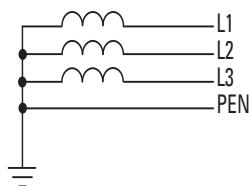
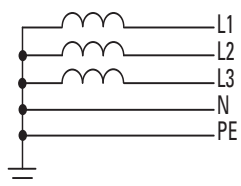

Connecting them to and operating them on asymmetrically earthed networks, such as phase-earthed delta networks (grounded delta, USA) or non-earthed or high-resistance earthed (> 30 Ω) IT networks is permitted with limitations. In these

networks, only variable frequency drives without internal radio interference suppression filters (EMC) may be used. On devices with internal radio interference suppression, the ground connection of the filter must be disconnected.

The standardized rated operating voltages of the power supply (EVU) assure the following conditions at the transfer point to the consumer:

- maximum deviation from the rated value for the voltage (U_{LN}): $\pm 10\%$
- Maximum deviation in the voltage symmetry: $\pm 3\%$
- Maximum deviation from the rated frequency value: $\pm 4\%$

In reference to the lower voltage value ($U_{LN} - 10\%$) the supply voltage is allowed to experience a further voltage drop of up to 4% in the consumer networks.

In ring-shaped powered network systems (e.g. in the EU), the standardized consumer voltages (230 V / 400 V / 690 V) are identical to the power supply levels of the utility companies. In star networks (for example in North America/USA), the stated consumer voltages take the voltage drop from the utility company's infed point to the last consumer into account.

Table: North American voltage level

Supply voltage U_{LN} of the utility company	Motor voltage according to UL 508 C	Consumer voltage, rated value for the motors
120 V	110 - 120 V	115 V
240 V	220 - 240 V	230 V
400 V	440 - 480 V	460 V
600 V	550 - 600 V	575 V

Safety and switching

With a variable frequency drive the assignment of components on the mains side in accordance with the rated operational current at the input end I_{LN} and the utilization category AC-1. Fuses, circuit-breakers and conductor cross-sections must meet the national and regional requirements and the required approvals at the point of operation.

To prevent fires and to protect people and farm animals from unacceptably high contact voltages, residual current devices (RCD) must be used in conjunction with a three-phase variable frequency drive, only AC/DC sensitive residual current devices (RCD, Type B) can be used.

Designation of residual current device for AC/DC-sensitive RCDs: Type B:



Earth leakage currents will be produced when using frequency-controlled drives due to the nature of the system. The main reasons for this consist of external capacitances between the phases of the motor cable, the motor cable's screening, star capacitors in the variable frequency drive, and radio interference suppression filters, as well as earthing measures at the motor's site of operation. These leakage currents can exceed 3.5 mA (AC) and/or greater than 10 mA (DC) can require improved PDS earthing as per EN 50178 (earth cable cross-section ≥ 10 mm (cable cross-section of earthing wire ≥ 10 mm²).

EMC compliance

Variable frequency drives work with fast electronic switches (IGBT) in the inverter. This can cause radio interference in a magnet system, which, in turn, can adversely affect nearby electronic equipment. To provide protection from these high-frequency interference sources, these should be spatially separated and screened from frequency-controlled drives.

In Europe, compliance with the EMC directive is mandatory, and is an essential requirement for CE marking. The EMC conditions for drive systems (PDS) are described in standard IEC/EN 61800-3. This product standard considers the complete magnet system from mains-side power supply right through to the motor. The Eaton variable frequency drive and speed starter with internal/external radio interference suppressor satisfy the requirements of the EMC product standard for the sensitive residential sector (first environment) and therefore also the higher limit values in the industrial sector (second environment).

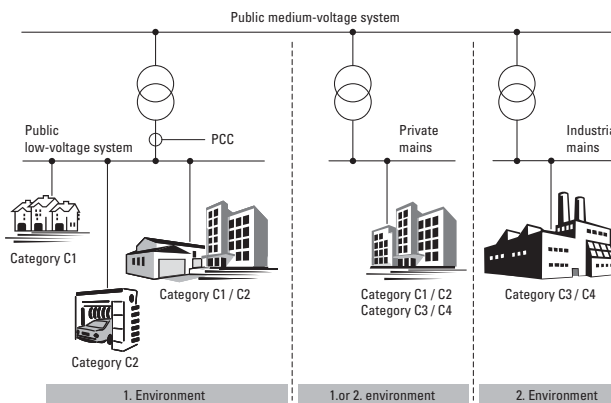

Variable frequency drives

A variable frequency drive is an electronic apparatus used for the variable-speed control of three-phase motors. It is intended for installation in a machine or for assembly with other components to a machine or plant. The main components of a compact design of modern variable frequency drive are a power section ① and a control section ②.

Functional actuation of the variable frequency drive and the output parameters in the power section (e.g. frequency, voltage and current) can be adjusted through:

- Control signal terminals (I/O) with analog and digital (binary) inputs,
- A keypad with function keys and display units,
- Serial interfaces (BUS) with RS485 (Modbus RTU) and optional fieldbus connections (CANopen, PROFIBUS-DP etc.) and an optional PC connection.

Internal open and closed-loop control circuits monitor all variable values in the variable frequency drive and automatically switch the process off if a value reaches a dangerous level.

- ① **Power section** with:
A = Rectifier
B = DC link
C = Inverter module (IGBT)
- ② **Control section** with:
I/O = analog and binary inputs and outputs

KEYPAD = keypad with display unit

BUS = serial interfaces (RS485, fieldbus, PC interface)

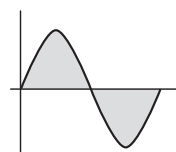
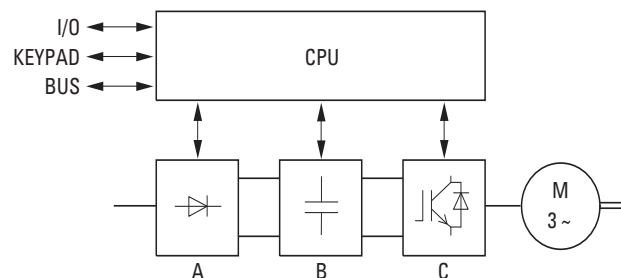
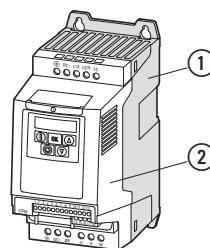

U_{LN} = Phase voltage from supplying AC mains



U_{DC} = DC link voltage
 $U_{DC} = 1.41 \times U_{LN}$

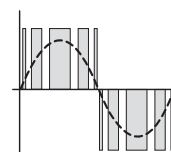

Output voltage = switched DC link voltage with sinusoidal pulse width modulation (PWM)

Block diagram with main components of a variable frequency drive

Control methods

The IGBTs in the inverter of the variable frequency drive are controlled with sinusoidal pulse-width modulation (PWM). In real-life applications, the industry draws a distinction between the following control methods:

- Voltage frequency control (U/f control),
- V/Hz control with slip compensation
- Sensorless vector control (speed control)
- Vector control (closed-loop), speed control.

The **voltage-frequency control section** is the best known and most frequently used process. A simple characteristic curve (linear or quadratic) defines the motor's rotating field frequency and the corresponding three-phase line-to-line motor voltage is selected such that the motor is neither over nor under-magnetized.

The main applications of the U/f control section are:

- pump and fan drives,
- horizontal conveying and transportation systems,
- multiple motor drives (parallel operation of several motors at the variable frequency drive's output).

With the **U/f control section with slip compensation** the load-dependent speed change of individual drives can be compensated for (without sensors).

With **sensor-less vector control** the magnetic fields of rotor and stator are opposed to one another. With asynchronous motors the magnetic flux in the rotor must be mapped in an electronic model of the motor. This requires the input of the physical parameters of the rating plate on the motor.

In vector operation, the variable frequency drive can only control one motor at the output end. A parallel operation of several motors is not possible here. The exact calculation of the phase voltages at the variable frequency drive's output, however, improves the motor's operational behavior. The motor also heats up less in the lower speed range. The field-oriented vector control results in a significant improvement in the drive dynamics as well as optimizing performance; it also increases the range of possible applications. The main applications of sensorless vector control are:

- Material machining and processing equipment
- Condensers (compressor),
- Heavy starting duty (extruder, agitators, mixer),
- Lifting mechanisms and lifting gear (vertical movement, crane, lift).

With the **vector feedback control** the output current of the variable frequency drive acts serves a controlled variable. This makes it possible to perfectly adjust the three-phase motor in line with the corresponding torque boost. The motor speed can be controlled in connection with an rpm sensor (tachometer, pulse generator) (closed loop).

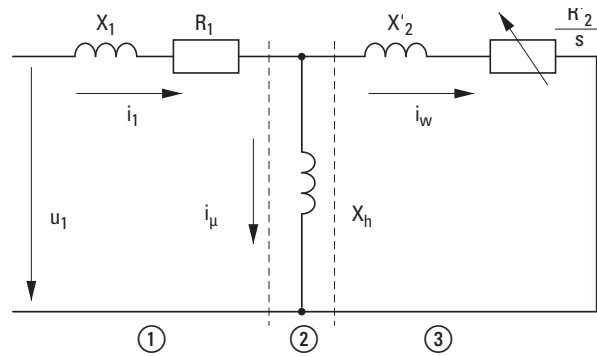

- ① Stator winding
- ② Air gap
- ③ transformed rotor winding

Simplified equivalent circuit diagram of a three-phase motor

Motor model

Regardless of the control method used, a variable frequency drive uses the measured voltage and current values on the stator winding (u_1 , i_1) to calculate the required manipulated variable for flux-generating component i_μ and the torque-forming magnitude in rotor i_w . The motor's load dependent slip is represented as resistor $R'2/s$. During no-load operation, this value approaches infinity ($i_w \rightarrow 0$). On the other hand, the value approaches zero as the load increases. The current in the rotor grows at this point.

Explanation:

EMC = Electromagnetic compatibility
 EVU = Utility company
 IGBT = Insulated gate bipolar transistor
 PDS = Power drives system
 RCD = Residual current device

Energy-efficient drive control technology (ErP directive)

The need for energy efficiency in a PDS and legislative specifications (EC 640/2009) has been redefined by the minimum efficiency ratings of motors. From 1 January 2017, all new motors entering service with a performance range of 0.75 to 315 kW shall not be less efficient than the IE3 efficiency level or shall meet the IE2 efficiency level and be equipped with an electronic speed control (variable frequency drive, variable speed starter). Under these conditions, the following versions of three-phase motor predominate at the present time:

- Three-phase asynchronous motor (DASM),
- Permanent magnet motor (PM),
- Synchronous reluctance motor (SynRM)

Within the same efficiency class, these three motor technologies have a comparable efficiency rating at their nominal operating point. However, there are significant differences in terms of startup behavior, in part-load operation, in respect of acquisition costs and in terms of size.

The asynchronous motor functions in accordance with the familiar principle whereby the creation of magnetic fields in stator and rotor give rise to repulsion and, in response to that, to rotational movement. This motor can be started directly off the mains supply.

PM motor are synchronous motors, i.e. there is no slip between the rotational fields of rotor and stator. The magnets assure magnetization of the rotor. That reduces losses in the rotor and increases the efficiency rating, especially at low speed. For starting and operational purposes, the PM motor needs to have a variable frequency drive (DA1).

With the SynRM motor, the rotor plates have specific cut sections. These guide the magnetic lines into the interior of the rotor and generate what is known as a reluctance torque. This results in a change of magnetic resistance and is characterized from about 11 kW by a very good efficiency rating at reduced speeds that changes under load. Here too, operation without friction and optimum speed control are only assured through the use of variable frequency drives (DA1).

In principle, all three variants operate using what is known as the U/f characteristics curve but the efficiency benefits of individual technologies are only guaranteed by feedback control algorithms adapted to suit the prevailing motor technology. With algorithms of this kind, motor operation can be optimized at every operating point, even with alternating loads.

Connection example for a 0.75 kW motor

Motor: P = 0.75 kW
 Supply system: 3/N/PE 400 V 50/60 Hz
 Connection examples meeting EMC requirements: Power section (see figure below)

Variant A:

Motor connected in a „delta circuit“

DC1... variable frequency drive with single-phase supply conductors (230 V)

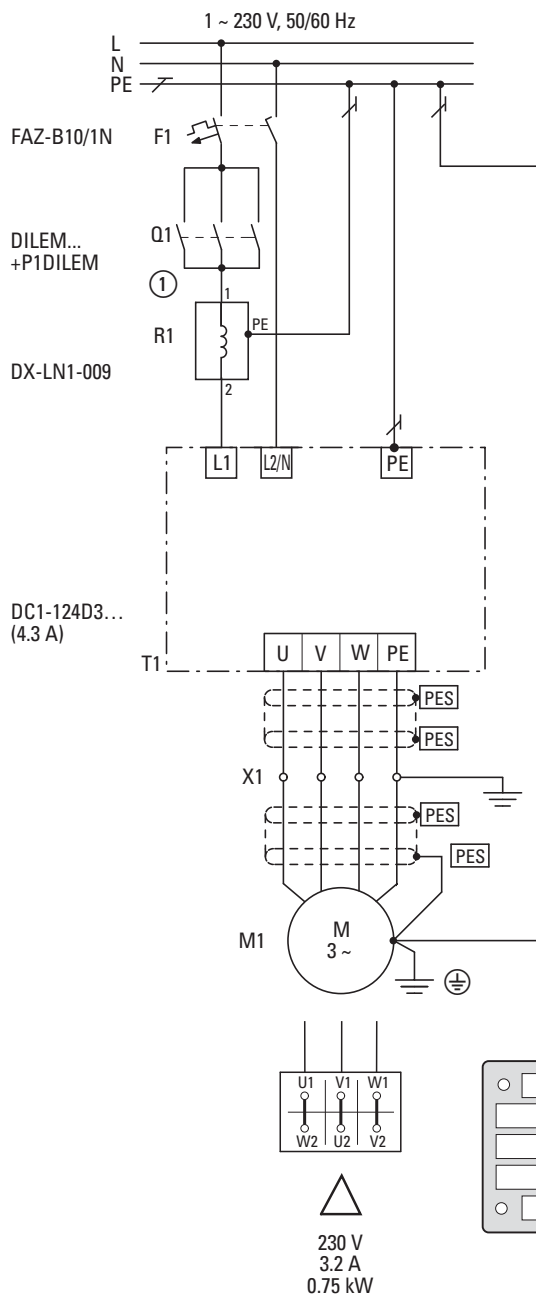

The 0.75 kW motor listed above can be connected up using a delta connection to a single-phase 230V mains supply (variant A) or in a star circuit on a 400V mains circuit (variant B).
 Taking due account of the selected mains voltage, the choice of variable frequency drive can either be 230V for 1 AC (DC1-124D3...) or 400V for 3 AC (MMX34AA2D4) and type-specific accessories.

Variant B:

Motor with 'star' circuit topology

variable frequency drive DC1... with three-phase mains supply conductors (400 V)

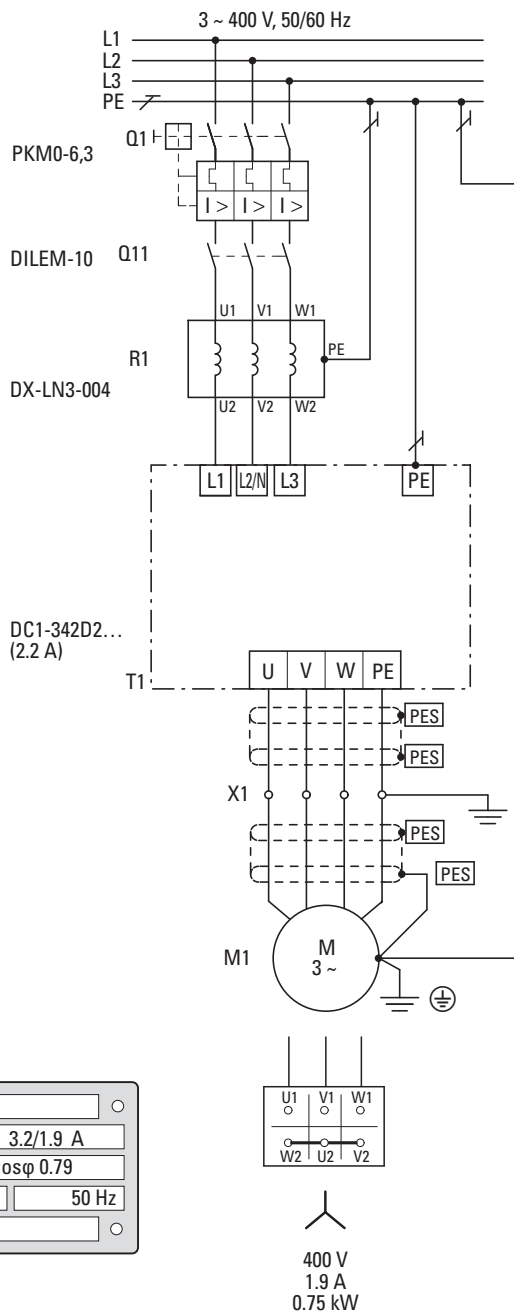

① An optional connection option for single-phase connection

Part no.	Motor Assigned motor rating ^{1), 2)} $I_H = 150\%$ P kW	Frequency inverters		Power Wiring		Mains contactor $I_H = 150\%$ (CT/ I_H , at 50 °C)	Main choke $I_H = 150\%$ (at 50 °C)
		Rated operational current ¹⁾ $I_H = 150\%$ I_e A	Input current $I_H = 150\%$ I_{LN} A	Safety device (fuse or miniature circuit-breaker)			
				IEC (Type B, gG), 150 %	UL (Class CC or J)		
					A		
PowerXL DE1 variable speed starters							
230 V AC, 1-phase/230 V AC, 3-phase							
DE1-121D4 ...	0.25	1.4	3.6	FAZ-B10/1N	10	DILEM-... + P1DILEM	DX-LN1-006
DE1-122D3 ...	0.37	2.3	6.2	FAZ-B10/1N	10	DILEM-... + P1DILEM	DX-LN1-009
DE1-122D7 ...	0.55	2.7	7.3	FAZ-B10/1N	10	DILEM-... + P1DILEM	DX-LN1-009
DE1-124D3 ...	0.75	4.3	11.3	FAZ-B16/1N	15	DILEM-... + P1DILEM	DX-LN1-013
DE1-127D0 ...	1.5	7	17.4	FAZ-B20/1N	20	DILEM-... + P1DILEM	DX-LN1-018
DE1-129D6 ...	2.2	9.6	23.2	FAZ-B32/1N	35	DILEM-... + P1DILEM	DX-LN1-024
400 V AC, 3-phase/400 V AC, 3-phase							
DE1-341D3 ...	0.37	1.3	1.7	FAZ-B6/3	6	DILEM-...	DX-LN3-004
DE1-342D1 ...	0.75	2.1	3.1	FAZ-B6/3	6	DILEM-...	DX-LN3-004
DE1-343D6 ...	1.5	3.6	4.9	FAZ-B6/3	6	DILEM-...	DX-LN3-006
DE1-345D0 ...	2.2	5	7	FAZ-B16/3	15	DILEM-...	DX-LN3-010
DE1-346D6 ...	3	6.6	8.5	FAZ-B16/3	15	DILEM-...	DX-LN3-010
DE1-348D5 ...	4	8.5	10	FAZ-B16/3	15	DILEM-...	DX-LN3-010
DE1-34011 ...	5.5	11.3	12	FAZ-B16/3	15	DILEM-...	DX-LN3-016
DE1-34016 ...	7.5	16	16.5	FAZ-B25/3	25	DILEM-...	DX-LN3-024
PowerXL variable frequency drives DC1							
115 V AC, single-phase/115 V AC, single-phase							
DC1-S17D0 ...	0.37	7	12.9	FAZ-B16/1N	15	DILEM-... + P1DILEM	DX-LN1-018
DC1-S1011 ...	0.55	10.5	19.2	FAZ-B25/1N	25	DILEM-... + P1DILEM	DX-LN1-024
230 V AC, 1-phase/230 V AC, single-phase							
DC1-S24D3 ...	0.37	4.3	7.5	FAZ-B10/1N	10	DILEM-... + P1DILEM	DX-LN1-009
DC1-S27D0 ...	0.75	7	12.9	FAZ-B16/1N	15	DILEM-... + P1DILEM	DX-LN1-018
DC1-S2011 ...	1.1	10.5	19.2	FAZ-B25/1N	25	DILEM-... + P1DILEM	DX-LN1-024
115 V AC, single-phase/230 V AC, 3-phase							
DC1-1D2D3 ...	0.37	2.3	7.8	FAZ-B16/1N	15	DILEM-... + P1DILEM	DX-LN1-009
DC1-1D4D3 ...	0.75	4.3	15.8	FAZ-B25/1N	25	DILEM-... + P1DILEM	DX-LN1-018
DC1-1D5D8 ...	1.1	5.8	21.9	FAZ-B32/1N	35	DILEM-... + P1DILEM	DX-LN1-024
230 V AC, 1-phase/230 V AC, 3-phase							
DC1-122D3 ...	0.37	2.3	3.7	FAZ-B10/1N	10	DILM7	DX-LN1-006
DC1-124D3 ...	0.75	4.3	7.5	FAZ-B10/1N	10	DILM7	DX-LN1-009
DC1-127D0 ...	1.5	7	12.9	FAZ-B16/1N	15	DILM7	DX-LN1-018
DC1-12011 ...	2.2	10.5	19.2	FAZ-B25/1N	25	DILM7	DX-LN1-024
DC1-12015 ...	4	15.3	29.2	FAZ-B40/1N	50	DILM7	DX-LN1-032
230 V AC, 3-phase/230 V AC, 3-phase							
DC1-322D3 ...	0.37	2.3	3.4	FAZ-B6/3	6	DILM7	DX-LN3-004
DC1-324D3 ...	0.75	4.3	5.6	FAZ-B6/3	6	DILM7	DX-LN3-006
DC1-327D0 ...	1.5	7	9.5	FAZ-B10/3	10	DILM7	DX-LN3-010
DC1-32011 ...	2.2	10.5	12.1	FAZ-B16/3	15	DILM7	DX-LN3-016
DC1-32018 ...	4	18	20.9	FAZ-B20/3	20	DILM7	DX-LN3-025
DC1-32030 ...	7.5	30	33.3	FAZ-B40/3	-	DILM17	DX-LN3-040
DC1-32046 ...	11	46	50.1	FAZ-B63/3	-	DILM40	DX-LN3-060
400 V AC, 3-phase/400 V AC, 3-phase							
DC1-342D2 ...	0.75	2.2	3.5	FAZ-B6/3	6	DILM7	DX-LN3-004
DC1-344D1 ...	1.5	4.1	5.6	FAZ-B6/3	6	DILM7	DX-LN3-006
DC1-345D8 ...	2.2	5.8	7.5	FAZ-B10/3	10	DILM7	DX-LN3-010
DC1-349D5 ...	4	9.5	11.5	FAZ-B16/3	15	DILM7	DX-LN3-016
DC1-34014 ...	5.5	14	17.2	FAZ-B20/3	20	DILM7	DX-LN3-025
DC1-34018 ...	7.5	18	21.2	FAZ-B25/3	25	DILM7	DX-LN3-025
DC1-34024 ...	11	24	27.5	FAZ-B32/3	35	DILM17	DX-LN3-040
DC1-34030 ...	15	30	34.2	FAZ-B40/3	-	DILM17	DX-LN3-040
DC1-34046 ...	22	46	51.9	FAZ-B63/3	-	DILM40	DX-LN3-060

Notes¹⁾ Overload cycle for 60 s every 600 s²⁾ for normal internally and externally ventilated 4 pole, three-phase asynchronous motors with 1500 rpm⁻¹ at 50 Hz or 1800 min⁻¹ at 60 Hz³⁾ Optional external radio interference suppression filter for longer motor cable lengths and for use in different EMC environments

Power Wiring Radio interference suppression filter (external, 150 %) ³⁾	DC link connection Braking resistance		Motor feeder motor choke	Sine filter
	10 % duty factor (DF)	20 % duty factor (DF)		
			$I_H = 150\%$ (CT/ I_H , at 50 °C)	$I_H = 150\%$ (CT/ I_H , at 50 °C)

DX-EMC12-019-FS1	-	-	DX-LM3-005	-
DX-EMC12-019-FS1	-	-	DX-LM3-005	-
DX-EMC12-019-FS1	-	-	DX-LM3-005	-
DX-EMC12-019-FS1	-	-	DX-LM3-005	-
DX-EMC12-019-FS1	-	-	DX-LM3-008	-
DX-EMC12-025-FS2	-	-	DX-LM3-011	-
DX-EMC34-008	-	-	DX-LM3-005	-
DX-EMC34-008	-	-	DX-LM3-005	-
DX-EMC34-008	-	-	DX-LM3-005	-
DX-EMC34-008	-	-	DX-LM3-008	-
DX-EMC34-016	-	-	DX-LM3-008	-
DX-EMC34-016	-	-	DX-LM3-011	-
DX-EMC34-016	-	-	DX-LM3-011	-
DX-EMC34-030	-	-	DX-LM3-016	-

DX-EMC12-014-FS1	-	-	-	-
DX-EMC12-025-FS2	DX-BR3-100	-	-	-

DX-EMC12-014-FS1	-	-	-	-
DX-EMC12-014-FS1	-	-	-	-
DX-EMC12-025-FS2	DX-BR3-100	-	-	-

DX-EMC12-014-FS1	-	-	DX-LM3-005	DX-SIN3-004
DX-EMC12-019-FS1	-	-	DX-LM3-005	DX-SIN3-010
DX-EMC12-025-FS2	-	-	DX-LM3-008	DX-SIN3-010

DX-EMC12-014-FS1	-	-	DX-LM3-005	DX-SIN3-004
DX-EMC12-014-FS1	-	-	DX-LM3-005	DX-SIN3-010
DX-EMC12-014-FS1	-	-	DX-LM3-008	DX-SIN3-010
DX-EMC12-025-FS2	DX-BR050-0K4	DX-BR050-0K8	DX-LM3-016	DX-SIN3-016
DX-EMC12-031-FS3	DX-BR050-0K4	DX-BR050-0K8	DX-LM3-016	DX-SIN3-016

DX-EMC34-008	-	-	DX-LM3-005	DX-SIN3-004
DX-EMC34-008	-	-	DX-LM3-005	DX-SIN3-010
DX-EMC34-016	-	-	DX-LM3-008	DX-SIN3-010
DX-EMC34-016	DX-BR050-0K4	DX-BR050-0K8	DX-LM3-016	DX-SIN3-016
DX-EMC34-030	DX-BR050-0K4	DX-BR050-0K8	DX-LM3-035	DX-SIN3-023
DX-EMC34-042	DX-BR022-1K4	DX-BR022-3K1	DX-LM3-035	DX-SIN3-032
DX-EMC34-055	DX-BR022-1K4	DX-BR022-3K1	DX-LM3-050	DX-SIN3-048

DX-EMC34-008	-	-	DX-LM3-005	DX-SIN3-004
DX-EMC34-008	-	-	DX-LM3-005	DX-SIN3-010
DX-EMC34-008	DX-BR100-0K8	DX-BR100-1K6	DX-LM3-008	DX-SIN3-010
DX-EMC34-016	DX-BR100-0K8	DX-BR100-1K6	DX-LM3-011	DX-SIN3-010
DX-EMC34-030	DX-BR047-3K1	DX-BR047-5K1	DX-LM3-016	DX-SIN3-016
DX-EMC34-030	DX-BR047-3K1	DX-BR047-5K1	DX-LM3-035	DX-SIN3-023
DX-EMC34-030	DX-BR047-3K1	DX-BR047-5K1	DX-LM3-035	DX-SIN3-023
DX-EMC34-042	DX-BR022-5K1	DX-BR022-9K2	DX-LM3-035	DX-SIN3-032
DX-EMC34-055	DX-BR022-5K1	DX-BR022-9K2	DX-LM3-050	DX-SIN3-048

Part no.	Motor Assigned motor rating ^{1),2)} $I_H = 150\%$ P kW	Frequency inverters		Power Wiring		Mains contactor $I_H = 150\%$ (CT/ I_H , at 50 °C)	Main choke $I_H = 150\%$ (at 50°C)
		Rated operational current ¹⁾ $I_H = 150\%$ I_e A	Input current $I_H = 150\%$ I_{LN} A	Safety device (fuse or miniature circuit-breaker) IEC (Type B, gG), 150 % UL (Class CC or J) A			

PowerXL variable frequency drives DA1

230 V AC, 1-phase/230 V AC, 3-phase

DA1-124D3 ...	0.75	4.3	8.6	FAZ-B16/1N	16	DILM7	DX-LN1-013
DA1-127D0 ...	1.5	7	12.9	FAZ-B20/1N	20	DILM7	DX-LN1-018
DA1-12011 ...	2.2	10.5	19.2	FAZ-B25/1N	25	DILM7	DX-LN1-024

230 V AC, 3-phase/230 V AC, 3-phase

DA1-324D3 ...	0.75	4.3	5.7	FAZ-B10/3	10	DILM7	DX-LN3-006
DA1-327D0 ...	1.5	7	10.5	FAZ-B10/3	15	DILM7	DX-LN3-010
DA1-32011 ...	2.2	10.5	13.2	FAZ-B16/3	17.5	DILM7	DX-LN3-016
DA1-32018 ...	4	18	20.9	FAZ-B25/3	30	DILM7	DX-LN3-025
DA1-32024 ...	5.5	24	26.4	FAZ-B40/3	40	DILM17	DX-LN3-025
DA1-32030 ...	7.5	30	33.3	FAZ-B50/3	50	DILM17	DX-LN3-040
DA1-32046 ...	11	46	50.1	FAZ-B63/3	70	DILM40	DX-LN3-050
DA1-32061 ...	15	61	63.9	NZMC1-S80	90	DILM50	DX-LN3-080
DA1-32072 ...	18.5	72	74	NZMC2-S125	110	DILM65	DX-LN3-080 ³⁾
DA1-32090 ...	22	90	99.1	NZMC2-S125	150	DILM80	DX-LN3-100 ³⁾
DA1-32110 ...	30	110	121	NZMC2-S160	175	DILM95	DX-LN3-120 ³⁾
DA1-32150 ...	45	150	159.7	NZMC2-S200	225	DILM150	DX-LN3-160 ³⁾
DA1-32180 ...	55	180	187.5	NZMC3-S250	250	DILM170	DX-LN3-200 ³⁾
DA1-32202 ...	55	202	206.5	NZMC3-S250	300	DILM185A	DX-LN3-250 ³⁾
DA1-32248 ...	75	248	255.5	NZMC3-S320	350	DILM185A	DX-LN3-300 ³⁾

400 V AC, 3-phase/400 V AC, 3-phase

DA1-342D2 ...	0.75	2.2	3.5	FAZ-B6/3	6	DILM7	DX-LN3-006
DA1-344D1 ...	1.5	4.1	5.6	FAZ-B10/3	10	DILM7	DX-LN3-006
DA1-345D8 ...	2.2	5.8	7.5	FAZ-B10/3	10	DILM7	DX-LN3-010
DA1-349D5 ...	4	9.5	11.5	FAZ-B16/3	15	DILM7	DX-LN3-010
DA1-34014 ...	5.5	14	17.2	FAZ-B25/3	25	DILM7	DX-LN3-016
DA1-34018 ...	7.5	18	21.8	FAZ-B32/3	30	DILM7	DX-LN3-025
DA1-34024 ...	11	24	27.5	FAZ-B40/3	40	DILM17	DX-LN3-025
DA1-34030 ...	15	30	34.2	FAZ-B50/3	50	DILM17	DX-LN3-040
DA1-34039 ...	18.5	39	44.1	FAZ-B63/3	60	DILM25	DX-LN3-040
DA1-34046 ...	22	46	51.9	NZMC1-S80	70	DILM40	DX-LN3-050
DA1-34061 ...	30	61	66.1	NZMC1-S80	80	DILM50	DX-LN3-080 ³⁾
DA1-34072 ...	37	72	77.3	NZMC1-S100	100	DILM65	DX-LN3-080 ³⁾
DA1-34090 ...	45	90	102.7	NZMC2-S125	125	DILM80	DX-LN3-100 ³⁾
DA1-34110 ...	55	110	126.4	NZMC2-S160	150	DILM95	DX-LN3-120 ³⁾
DA1-34150 ...	75	150	164.7	NZMC2-S200	200	DILM150	DX-LN3-160 ³⁾
DA1-34180 ...	90	180	192.1	NZMC3-S250	250	DILM170	DX-LN3-200 ³⁾
DA1-34202 ...	110	202	210.8	NZMC3-S320	300	DILM185A	DX-LN3-250 ³⁾
DA1-34240 ...	132	240	244.5	NZMC3-S320	350	DILM185A	DX-LN3-250 ³⁾
DA1-34302 ...	160	302	307.8	NZMC3-S400	400	DILM225A	DX-LN3-370 ³⁾
DA1-34370 ...	200	370	377.2	NZMC3-S500	500	DILM400	DX-LN3-370 ⁴⁾
DA1-34450 ...	250	450	458.7	NZMH3-AE630-T	600	DILM400	DX-LN3-450 ⁴⁾

Notes

¹⁾ Overload cycle for 60 s every 600 s

²⁾ for normal internally and externally ventilated 4 pole, three-phase asynchronous motors with 1500 rpm⁻¹ at 50 Hz or 1800 rpm⁻¹ at 60 Hz

³⁾ Mains choke recommended only if the power quality is poor. Current harmonics (THD) are attenuated by internal DC link chokes.

⁴⁾ Use of line choke ($U_K=1-4\%$) is mandatory, if line impedance > 1 % cannot be assured

⁵⁾ Optional external radio interference suppression filter for longer motor cable lengths and for use in different EMC environments

Power Wiring	DC link connection		Motor feeder motor choke	Sine filter
	Braking resistance			
Radio interference suppression filter (external, 150 %)⁵)	10 % duty factor (DF)	20 % duty factor (DF)	$I_H = 150\%$ (CT/I_H , at 50 °C)	$I_H = 150\%$ (CT/I_H , at 50 °C)

DX-EMC12-014-FS2	DX-BR100-0K2	DX-BR100-0K4	DX-LM3-005	DX-SIN3-010
DX-EMC12-014-FS2	DX-BR050-0K4	DX-BR050-0K8	DX-LM3-008	DX-SIN3-010
DX-EMC12-025-FS2	DX-BR050-0K8	DX-BR035-1K1	DX-LM3-016	DX-SIN3-016

DX-EMC34-008	DX-BR100-0K2	DX-BR100-0K4	DX-LM3-005	DX-SIN3-010
DX-EMC34-008	DX-BR050-0K4	DX-BR050-0K8	DX-LM3-008	DX-SIN3-010
DX-EMC34-016	DX-BR050-0K8	DX-BR035-1K1	DX-LM3-016	DX-SIN3-016
DX-EMC34-030	DX-BR022-1K4	DX-BR022-3K1	DX-LM3-035	DX-SIN3-023
DX-EMC34-030	DX-BR022-1K4	DX-BR022-3K1	DX-LM3-035	DX-SIN3-032
DX-EMC34-042	DX-BR022-1K4	DX-BR022-3K1	DX-LM3-035	DX-SIN3-032
DX-EMC34-055	DX-BR022-1K4	DX-BR022-3K1	DX-LM3-050	DX-SIN3-048
DX-EMC34-075	DX-BR012-3K1	DX-BR012-5K1	DX-LM3-063	DX-SIN3-061
DX-EMC34-075	DX-BR012-3K1	DX-BR012-5K1	DX-LM3-080	DX-SIN3-072
DX-EMC34-100	DX-BR006-5K1	DX-BR006-9K2	DX-LM3-100	DX-SIN3-090
DX-EMC34-130	DX-BR006-5K1	DX-BR006-9K2	DX-LM3-150	DX-SIN3-115
DX-EMC34-180	DX-BR006-5K1	DX-BR006-9K2	DX-LM3-180	DX-SIN3-150
DX-EMC34-250	DX-BR006-5K1	DX-BR006-9K2	DX-LM3-220	DX-SIN3-180
DX-EMC34-250	DX-BR006-5K1	DX-BR006-9K2	DX-LM3-220	DX-SIN3-250
DX-EMC34-400	DX-BR006-5K1	DX-BR006-9K2	DX-LM3-260	DX-SIN3-250

DX-EMC34-008	DX-BR400-0K4	DX-BR400-0K4	DX-LM3-005	DX-SIN3-004
DX-EMC34-008	DX-BR200-0K4	DX-BR200-0K8	DX-LM3-005	DX-SIN3-010
DX-EMC34-008	DX-BR150-0K5	DX-BR150-1K4	DX-LM3-008	DX-SIN3-010
DX-EMC34-016	DX-BR100-0K8	DX-BR100-1K4	DX-LM3-011	DX-SIN3-010
DX-EMC34-016	DX-BR075-1K4	DX-BR075-5K1	DX-LM3-016	DX-SIN3-016
DX-EMC34-030	DX-BR050-3K1	DX-BR050-5K1	DX-LM3-035	DX-SIN3-023
DX-EMC34-030	DX-BR040-3K1	DX-BR040-5K1	DX-LM3-035	DX-SIN3-023
DX-EMC34-042	DX-BR022-5K1	DX-BR022-9K2	DX-LM3-035	DX-SIN3-032
DX-EMC34-042	DX-BR022-5K1	DX-BR022-9K2	DX-LM3-050	DX-SIN3-048
DX-EMC34-055	DX-BR022-5K1	DX-BR022-9K2	DX-LM3-050	DX-SIN3-048
DX-EMC34-075	DX-BR012-9K2	DX-BR012-18K1	DX-LM3-063	DX-SIN3-061
DX-EMC34-075	DX-BR012-9K2	DX-BR012-18K1	DX-LM3-080	DX-SIN3-090
DX-EMC34-100	DX-BR006-18K1	DX-BR006-33K3	DX-LM3-100	DX-SIN3-090
DX-EMC34-130	DX-BR006-18K1	DX-BR006-33K3	DX-LM3-150	DX-SIN3-115
DX-EMC34-180	DX-BR006-18K1	DX-BR006-33K3	DX-LM3-180	DX-SIN3-150
DX-EMC34-250	DX-BR006-18K1	DX-BR006-33K3	DX-LM3-220	DX-SIN3-180
DX-EMC34-250	DX-BR006-18K1	DX-BR006-33K3	DX-LM3-220	DX-SIN3-250
DX-EMC34-250	DX-BR006-18K1	DX-BR006-33K3	DX-LM3-260	DX-SIN3-250
DX-EMC34-400	DX-BR006-18K1	DX-BR006-33K3	DX-LM3-370	DX-SIN3-440
DX-EMC34-400	DX-BR002-54K3	DX-BR002-102K4	DX-LM3-450	DX-SIN3-440
DX-EMC34-750	DX-BR002-54K3	DX-BR002-102K4	-	DX-SIN3-480

Part no.	Motor Assigned motor rating ^{1),2)} $I_H = 150\%$ P kW	Frequency inverters		Power Wiring		Mains contactor $I_H = 150\%$ (CT/ I_H , at 50 °C)	Main choke $I_H = 150\%$ (at 50°C)
		Rated operational current ¹⁾ $I_H = 150\%$ I_e A	Input current $I_H = 150\%$ I_{LN} A	Safety device (fuse or miniature circuit-breaker) IEC (Type B, gG), 150 % ³⁾	UL (Class CC or J) ⁴⁾ A		

PowerXL variable frequency drives DA1

500 V AC, 3-phase/500 V AC, 3-phase

Part no.	Motor rating ^{1),2)}	Rated operational current ¹⁾	Input current	Safety device	UL	Mains contactor	Main choke
DA1-352D1 ...	0.75	2.1	3.4	6NHG000B	LPJ-6SP	DILM7	DX-LN3-004
DA1-353D1 ...	1.5	3.1	4.2	6NHG000B	LPJ-6SP	DILM7	DX-LN3-004
DA1-354D1 ...	2.2	4.1	4.9	10NHG000B	LPJ-10SP	DILM7	DX-LN3-006
DA1-356D5 ...	4	6.5	8.6	10NHG000B	LPJ-10SP	DILM7	DX-LN3-010
DA1-359D0 ...	5.5	9	12.2	16NHG000B	LPJ-15SP	DILM7	DX-LN3-016
DA1-35012 ...	7.5	12	15.1	20NHG000B	LPJ-20SP	DILM7	DX-LN3-016
DA1-35017 ...	11	17	20.9	32NHG000B	LPJ-30SP	DILM17	DX-LN3-025
DA1-35022 ...	15	22	26	40NHG000B	LPJ-35SP	DILM17	DX-LN3-040
DA1-35028 ...	18.5	28	32.2	50NHG000B	LPJ-45SP	DILM17	DX-LN3-040
DA1-35034 ...	22	34	39.1	63NHG000B	LPJ-60SP	DILM25	DX-LN3-050
DA1-35043 ...	30	43	48.9	63NHG000B	LPJ-70SP	DILM40	DX-LN3-050
DA1-35054 ...	37	54	59.9	80NHG000B NZMC1-S80	LPJ-80SP	DILM50	DX-LN3-080
DA1-35065 ...	45	65	70.4	100NHG000B NZMC1-S100	LPJ-100SP	DILM80	DX-LN3-080
DA1-35078 ...	55	78	90.6	125NHG000B NZMC2-S125	LPJ-125SP	DILM95	DX-LN3-100
DA1-35105 ...	75	105	121.1	160NHG000B NZMC2-S160	LPJ-150SP	DILM95	DX-LN3-120
DA1-35130 ...	90	130	143.2	160NHG000B NZMC2-S160	LPJ-175SP	DILM115	DX-LN3-160
DA1-35150 ...	110	150	158.4	200NHG1B NZMC2-S200	LPJ-200-SP	DILM150	DX-LN3-160

Notes

¹⁾ Overload cycle for 60 s every 600 s

²⁾ for normal internally and externally ventilated 4 pole, three-phase asynchronous motors with 1500 rpm⁻¹ at 50 Hz or 1800 min⁻¹ at 60 Hz

³⁾ NH fuse used together with TB00-D fuse base

⁴⁾ LPJ fuse used together with J60060-3 fuse base

⁵⁾ Optional external radio interference suppression filter for longer motor cable lengths and for use in different EMC environments

Power Wiring	DC link connection		Motor feeder	Sine filter
	Braking resistance		motor choke	
Radio interference suppression filter (external, 150 %) ⁵⁾	10 % duty factor (DF)	20 % duty factor (DF)	$I_H = 150 \%$ (CT/I_H , at 50 °C)	$I_H = 150 \%$ (CT/I_H , at 50 °C)

-	-	-	DX-LM3-005	SIN-0005-6-0-P
-	DX-BR400-0K4	-	DX-LM3-005	SIN-0005-6-0-P
-	DX-BR200-0K4	DX-BR200-0K8	DX-LM3-005	SIN-0005-6-0-P
-	DX-BR150-0K5	DX-BR150-1K4	DX-LM3-008	SIN-0008-6-0-P
-	DX-BR100-0K8	DX-BR100-1K4	DX-LM3-011	SIN-0014-6-0-P
-	DX-BR100-0K8	DX-BR100-1K6	DX-LM3-016	SIN-0014-6-0-P
-	DX-BR050-3K1	DX-BR050-5K1	DX-LM3-035	SIN-0023-6-0-P
-	DX-BR040-3K1	DX-BR040-5K1	DX-LM3-035	SIN-0035-6-0-P
-	DX-BR040-3K1	DX-BR040-5K1	DX-LM3-035	SIN-0035-6-0-P
-	DX-BR022-3K1	DX-BR022-5K1	DX-LM3-035	SIN-0052-6-0-P
-	DX-BR022-3K1	DX-BR022-5K1	DX-LM3-050	SIN-0052-6-0-P
-	DX-BR022-3K1	DX-BR022-5K1	DX-LM3-063	SIN-0085-6-0-P
-	DX-BR012-3K1	DX-BR012-5K1	DX-LM3-080	SIN-0085-6-0-P
-	DX-BR012-3K1	DX-BR012-5K1	DX-LM3-080	SIN-0085-6-0-P
-	DX-BR012-3K1	DX-BR012-5K1	DX-LM3-150	SIN-0122-6-0-P
-	DX-BR012-3K1	DX-BR012-9K2	DX-LM3-150	SIN-0185-6-0-P
-	DX-BR012-3K1	DX-BR012-18K1	DX-LM3-150	SIN-0185-6-0-P

Part no.	Motor		Frequency inverters				Power Wiring		Mains contactor	
	Assigned motor rating ^{1), 2)}		Rated operational current ¹⁾		Input current		Safety device (fuse or miniature circuit-breaker)			
	I _H = 150 %	I _L = 110 %	I _H = 150 %	I _L = 110 %	I _H = 150 %	I _L = 110 %	IEC (Type B, gG), 150 %	UL (Class CC or J)	I _H = 150 % (CT/I _H , at 50 °C)	I _L = 110 % (VT/I _L , at 40 °C)
P	P	I _e	I _e	I _{LN}	I _{LN}		A			
kW	kW	A	A	A	T					
-PowerXL variable frequency drive DG1										
230 V AC, 3-phase/230 V AC, 3-phase										
DG1-323D7 ...	0.75	1.1	3.7	4.8	3.2	4.4	PKZM0-4	10	DILM7	DILM7
DG1-324D8 ...	1.1	1.5	4.8	6.6	4.4	6.1	PKZM0-6,3	10	DILM7	DILM7
DG1-326D6 ...	1.5	1.5	6.6	7.8	6.1	7.2	PKZM0-10	10	DILM7	DILM7
DG1-327D8 ...	1.5	2.2	7.8	11	7.2	10.2	PKZM0-10	15	DILM7	DILM7
DG1-32011 ...	2.2	3	11	12.5	10.2	11.6	PKZM0-12	15	DILM7	DILM7
DG1-32012 ...	3	4	12.5	17.5	10.2	16.3	PKZM0-16	20	DILM7	DILM7
DG1-32017 ...	4	5.5	17.5	25	16.2	23.2	PKZM0-20	30	DILM7	DILM17
DG1-32025 ...	5.5	7.5	25	31	23.1	29	PKZM0-25	35	DILM17	DILM17
DG1-32031 ...	7.5	11	31	48	28.7	44.2	PKZM0-32	60	DILM17	DILM40
DG1-32048 ...	11	15	48	61	44.4	56	PKZM4-50	63	DILM40	DILM50
DG1-32061 ...	15	22	61	75	54.4	64.6	PKZM4-63	100	DILM50	DILM65
DG1-32075 ...	22	22	75	88	69.4	78	NZMC1-A80	110	DILM65	DILM80
DG1-32088 ...	22	30	88	114	81.4	94.3	NZMC1-A100	125	DILM80	DILM115
DG1-32114 ...	30	45	114	143	105.5	129	NZMC1-A125	175	DILM115	DILM150
DG1-32143 ...	45	45	143	170	132.2	157	NZMC1-A160	200	DILM150	DILM170
DG1-32170 ...	45	55	170	211	157.3	189	NZMC2-A200	250	DILM170	DILM185A
400 V AC, 3-phase/400 V AC, 3-phase										
DG1-342D2 ...	0.75	1.1	2.2	3.3	2	3.1	PKZM0-2,5	10	DILM7	DILM7
DG1-343D3 ...	1.1	1.5	3.3	4.3	3.1	4	PKZM0-4	10	DILM7	DILM7
DG1-344D3 ...	1.5	2.2	4.3	5.6	4	5.2	PKZM0-6,3	10	DILM7	... DILM7
DG1-345D6 ...	2.2	3	5.6	7.6	5.2	7.1	PKZM0-6,3	10	DILM7	DILM7
DG1-347D6 ...	3	4	7.6	9	7.1	8.4	PKZM0-10	15	DILM7	DILM7
DG1-349D0 ...	4	5.5	9	12	8.4	11.2	PKZM0-10	15	DILM7	DILM7
DG1-34012 ...	5.5	7.5	12	16	11.2	15	PKZM0-12	20	DILM7	DILM7
DG1-34016 ...	7.5	11	16	23	15	21.5	PKZM0-16	30	DILM7	DILM17
DG1-34023 ...	11	15	23	31	21.5	29	PKZM0-25	35	DILM17	DILM17
DG1-34031 ...	15	18.5	31	38	29	35.2	PKZM0-32	50	DILM17	DILM17
DG1-34038 ...	18.5	22	38	46	35.2	42.6	PKZM4-40	60	DILM17	DILM40
DG1-34046 ...	22	30	46	61	42.6	55.7	PKZM4-50	80	DILM40	DILM50
DG1-34061 ...	30	37	61	72	55.7	65.7	PKZM4-63	100	DILM50	DILM65
DG1-34072 ...	37	45	72	87	65.7	79.4	NZMC1-A80	110	DILM65	DILM80
DG1-34087 ...	45	55	87	105	79.4	97	NZMC1-A100	125	DILM80	DILM95
DG1-34105 ...	55	75	105	140	97	129	NZMC1-A125	175	DILM95	DILM150
DG1-34140 ...	75	90	140	170	129	157	NZMC1-A160	200	DILM150	DILM170
DG1-34170 ...	90	110	170	205	157	189	NZMC2-A200	250	DILM170	DILM185A

Notes

¹⁾ Overload cycle for 60 s every 600 s

²⁾ for normal internally and externally ventilated 4 pole, three-phase asynchronous motors with 1500 rpm⁻¹ at 50 Hz or 1800 min⁻¹ at 60 Hz

³⁾ Optional external radio interference suppression filter for longer motor cable lengths and for use in different EMC environments

DC link connection			Motor feeder		Sine filter	
Braking resistance			motor choke			
10 % duty factor (DF)	20 % duty factor (DF)	40 % duty factor (DF)	$I_H = 150\%$ (CT/ I_H , at 50 °C)	$I_L = 110\%$ (VT/ I_L , at 40 °C)	$I_H = 150\%$ (CT/ I_H , at 50 °C)	$I_L = 110\%$ (VT/ I_L , at 40 °C)

DX-BR035-1K1	DX-BR040-3K1	DX-BR040-3K1	DX-LM3-005	DX-LM3-005	DX-SIN3-004	DX-SIN3-010
DX-BR035-1K1	DX-BR040-3K1	DX-BR040-3K1	DX-LM3-005	DX-LM3-008	DX-SIN3-010	DX-SIN3-010
DX-BR035-1K1	DX-BR040-3K1	DX-BR040-3K1	DX-LM3-008	DX-LM3-008	DX-SIN3-010	DX-SIN3-010
DX-BR035-1K1	DX-BR040-3K1	DX-BR040-3K1	DX-LM3-008	DX-LM3-011	DX-SIN3-010	DX-SIN3-016
DX-BR035-1K1	DX-BR040-3K1	DX-BR040-3K1	DX-LM3-011	DX-LM3-016	DX-SIN3-016	DX-SIN3-016
DX-BR022-1K4	DX-BR022-3K1	DX-BR022-5K1	DX-LM3-016	DX-LM3-035	DX-SIN3-016	DX-SIN3-023
DX-BR022-1K4	DX-BR022-3K1	DX-BR022-5K1	DX-LM3-035	DX-LM3-035	DX-SIN3-023	DX-SIN3-032
DX-BR022-1K4	DX-BR022-3K1	DX-BR022-5K1	DX-LM3-035	DX-LM3-035	DX-SIN3-032	DX-SIN3-032
P:4 x DX-BR047-9K2	P:4 x DX-BR047-9K2	P:4 x DX-BR047-9K2	DX-LM3-035	DX-LM3-050	DX-SIN3-032	DX-SIN3-048
P:4 x DX-BR047-9K2	P:4 x DX-BR047-9K2	P:4 x DX-BR047-9K2	DX-LM3-050	DX-LM3-063	DX-SIN3-048	DX-SIN3-061
-	-	-	DX-LM3-063	DX-LM3-080	DX-SIN3-061	DX-SIN3-090
-	-	-	DX-LM3-080	DX-LM3-100	DX-SIN3-090	DX-SIN3-090
R:2 x DX-BR002-54K3	R:2 x DX-BR002-54K3	R:2 x DX-BR002-54K3	DX-LM3-100	DX-LM3-150	DX-SIN3-090	DX-SIN3-115
-	-	-	DX-LM3-150	DX-LM3-150	DX-SIN3-115	DX-SIN3-150
-	-	-	DX-LM3-150	DX-LM3-180	DX-SIN3-150	DX-SIN3-180
P:4 x DX-BR006-5K1	DX-BR002-54K3	DX-BR002-54K3	DX-LM3-180	DX-LM3-220	DX-SIN3-180	DX-SIN3-250

DX-BR075-1K4	DX-BR075-5K1	DX-BR075-5K1	DX-LM3-005	DX-LM3-005	DX-SIN3-004	DX-SIN3-004
DX-BR075-1K4	DX-BR075-5K1	DX-BR075-5K1	DX-LM3-005	DX-LM3-005	DX-SIN3-004	DX-SIN3-010
DX-BR075-1K4	DX-BR075-5K1	DX-BR075-5K1	DX-LM3-005	DX-LM3-008	DX-SIN3-010	DX-SIN3-010
DX-BR075-1K4	DX-BR075-5K1	DX-BR075-5K1	DX-LM3-008	DX-LM3-008	DX-SIN3-010	DX-SIN3-010
DX-BR075-1K4	DX-BR075-5K1	DX-BR075-5K1	DX-LM3-008	DX-LM3-011	DX-SIN3-010	DX-SIN3-010
DX-BR075-1K4	DX-BR075-5K1	DX-BR075-5K1	DX-LM3-011	DX-LM3-016	DX-SIN3-010	DX-SIN3-016
DX-BR047-3K1	DX-BR047-5K1	DX-BR047-9K2	DX-LM3-016	DX-LM3-016	DX-SIN3-016	DX-SIN3-016
DX-BR047-3K1	DX-BR047-5K1	DX-BR047-9K2	DX-LM3-016	DX-LM3-035	DX-SIN3-016	DX-SIN3-023
DX-BR047-3K1	DX-BR047-5K1	DX-BR047-9K2	DX-LM3-035	DX-LM3-035	DX-SIN3-023	DX-SIN3-032
P:3 x DX-BR047-3K1	P:3 x DX-BR047-5K1	P:3 x DX-BR047-9K2	DX-LM3-035	DX-LM3-050	DX-SIN3-032	DX-SIN3-048
P:3 x DX-BR047-3K1	P:3 x DX-BR047-5K1	P:3 x DX-BR047-9K2	DX-LM3-050	DX-LM3-050	DX-SIN3-048	DX-SIN3-048
P:3 x DX-BR047-3K1	P:3 x DX-BR047-5K1	P:3 x DX-BR047-9K2	DX-LM3-050	DX-LM3-063	DX-SIN3-048	DX-SIN3-061
P:3 x DX-BR022-5K1	P:3 x DX-BR022-9K2	R:4 x DX-BR002-54K3	DX-LM3-063	DX-LM3-080	DX-SIN3-061	DX-SIN3-072
-	-	-	DX-LM3-080	DX-LM3-100	DX-SIN3-072	DX-SIN3-090
-	-	-	DX-LM3-100	DX-LM3-150	DX-SIN3-090	DX-SIN3-115
-	-	-	DX-LM3-150	DX-LM3-150	DX-SIN3-115	DX-SIN3-150
-	-	-	DX-LM3-150	DX-LM3-180	DX-SIN3-150	DX-SIN3-180
-	-	-	DX-LM3-180	DX-LM3-220	DX-SIN3-180	DX-SIN3-250



9000X SVX, SPX variable frequency drive

9000X variable frequency drives are perfect for applications that require only the best. The SVX series of standard variable frequency drives is designed to easily meet the needs of simple and complex motor controllers in the industrial machine-building industry, while the SPX series of special-purpose variable frequency drives is ideal for sophisticated, high-performance applications. Whether run in open-loop or closed-loop mode, their vector control ensures reliable and dynamically responsive motor control for three-phase induction and PM motors.

SVX variable frequency drive

Variable frequency drives for operation with two overload profiles: 150% or 110%. The compact enclosures are available in IP21 (NEMA 1) and IP54 (NEMA 12) versions and feature an integrated radio interference suppression filter. A braking chopper is always integrated in frame sizes of up to FR6, and there are two types available.

SVX...-4A...: U_{IN} 3~400 V/ U_{OUT} 3~400 V, allocated motor outputs 0.75 – 132 kW

SVX...-5A...: U_{IN} 3~690 V/ U_{OUT} 3~690 V, allocated motor outputs 2.2 – 160 kW

SPX variable frequency drive

Variable frequency drives for operation with two overload profiles of 150% and 110%. The enclosures for these compact devices are available in versions with an IP21 (NEMA 1) or IP54 (NEMA 12) degree of protection and feature an integrated radio interference suppression filter. A braking chopper is always integrated in frame sizes of up to FR6, and there are two types available.

SPX...-4A...: U_{IN} 3~400 V/ U_{OUT} 3~400 V, allocated motor outputs 0.75 – 1200 kW

SPX...-5A...: U_{IN} 3~690 V/ U_{OUT} 3~690 V, allocated motor outputs 2.2 – 2000 kW



Description

Variable frequency drive SVX, SPX	76
-----------------------------------	----

Key to type references, UL/CSA

Variable frequency drive SVX, SPX	77
-----------------------------------	----

Ordering

Variable frequency drive SVX, IP21	78
------------------------------------	----

Variable frequency drive SVX, IP54	81
------------------------------------	----

Variable frequency drive SPX, IP00/IP21	84
---	----

Variable frequency drive SPX, IP54	88
------------------------------------	----

Accessories	91
-------------	----

Mains chokes, Motor chokes, Sine filter	60
---	----

Engineering

Assigned switching and protective elements	94
--	----

Description

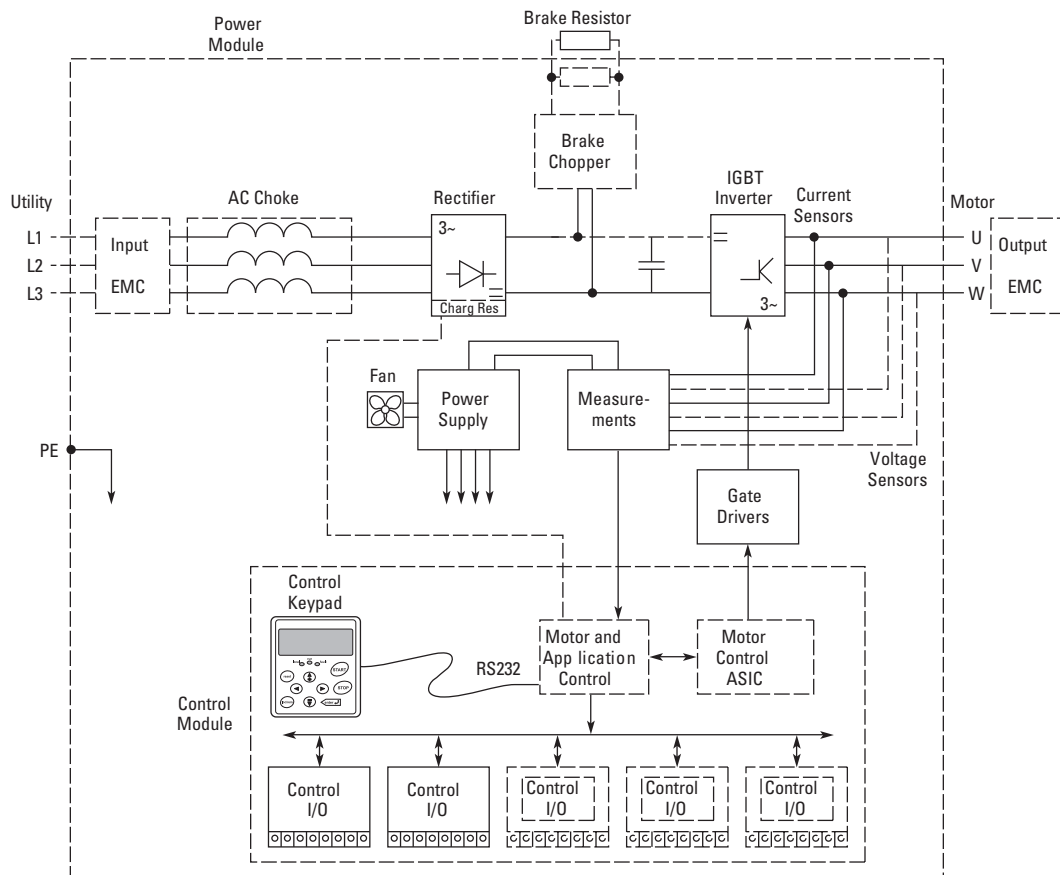

SVX variable frequency drive

SVX units are heavy-duty, all-purpose standard variable frequency drives. Featuring a variety of application settings, they can be configured to meet virtually any challenge that arises when used to control induction motors, including applications involving multiple motors or multiple pumps run in parallel. SVX variable frequency drives are suitable for all standard applications in machines, buildings, and industrial projects. One of the factors contributing to this is their sturdy design, which features integrated chokes and EMC filters and provides effective protection against interference from the grid. In addition, their sophisticated motor control design and effective protection features for both motor and variable frequency drive guarantee reliable operation.

Essential features

- Performance range:
 - 0.75 - 132 kW (U_{IN} : 3~ 400 V / U_{OUT} : 3~ 400 V)
 - 2.2 - 160 kW (U_{IN} : 3~ 690 V / U_{OUT} : 3~ 690 V)
- High load capacity:
 - H = 2x rated operational current (2 seconds/20 seconds) and 150% overload (60 seconds/600 seconds)
 - L = 2x rated operational current (2 seconds/20 seconds) and 110% overload (60 seconds/600 seconds)
- Ambient air temperature: -10 °C up to +50 °C without derating
- Degree of protection with compact design: IP21 (NEMA1) and IP54 (NEMA12)
- I/O expansion with plug-in modules (5 slots)
- Optional fieldbus connection (CANopen, PROFIBUS-DP, DeviceNet), LonWorks
- PID control and power factor correction (PFC) for 1 to 5 pumps
- Programmable start and application wizard for an easy parameter configuration process
- Multiple display (multi-monitoring) for monitoring up to 3 different readings at the same time
- V/Hz control with boost and slip compensation
- Dynamic open-loop and closed-loop vector control
- Internal braking chopper available in sizes of up to FR9 (compact design)

SPX variable frequency drive

SPX variable frequency drives are the perfect choice when it comes to demanding applications in which reliability, a highly dynamic response, precision, and power are a must. Popular applications include lifting equipment and conveyances (cranes, winches, elevators, lifts), compressors and oil pumps, chippers, crushers, mixers, extruders, take-up and pay-off units, and tunnel boring machines. Multi-purpose SPX variable frequency drives are designed to cover a wide variety of applications while keeping things simple. In fact, with their excellent flexibility, they make it easy to adapt to additional process requirements for custom and complex applications used to control induction and permanent magnet motors. On top of this, their sturdy design, which features integrated chokes and EMC filters, provides effective protection against interference from the grid. Finally, their sophisticated motor control design and effective protection features for both motor and variable frequency drive guarantee reliable operation.

Essential features

- Performance range:
 - 0.75 - 132 kW (U_{IN} : 3~ 400 V / U_{OUT} : 3~ 400 V)
 - 2.2 - 160 kW (U_{IN} : 3~ 690 V / U_{OUT} : 3~ 690 V)
- Expanded performance range with distributed design (IP00). Please enquire:
 - up to 1100 kW (U_{IN} : 3~ 400 V / U_{OUT} : 3~ 400 V)
 - up to 2000 kW (U_{IN} : 3~ 690 V / U_{OUT} : 3~ 690 V)
- High load capacity:
 - H = 2x rated operational current (2 seconds/20 seconds) and 150% overload (60 seconds/600 seconds)
 - L = 2x rated operational current (2 seconds/20 seconds) and 110% overload (60 seconds/600 seconds)
- Ambient air temperature: -10 °C up to +50 °C without derating
- Degree of protection with compact design: Up to 132/160 kW: IP21 (NEMA1) and IP54 (NEMA12)
- I/O expansion with plug-in modules (5 slots)
- Optional fieldbus connection (CANopen, PROFIBUS-DP, DeviceNet), LonWorks
- PID control and power factor correction (PFC)
- Direct and parallel circuit solutions, even for PM motors with high outputs
- Programmable start and application wizard for an easy parameter configuration process
- Multiple display (multi-monitoring) for monitoring up to 3 different readings at the same time
- V/Hz control with boost and slip compensation
- Dynamic open-loop and closed-loop vector control
- Internal braking chopper available in sizes up to FR9

Key to type references

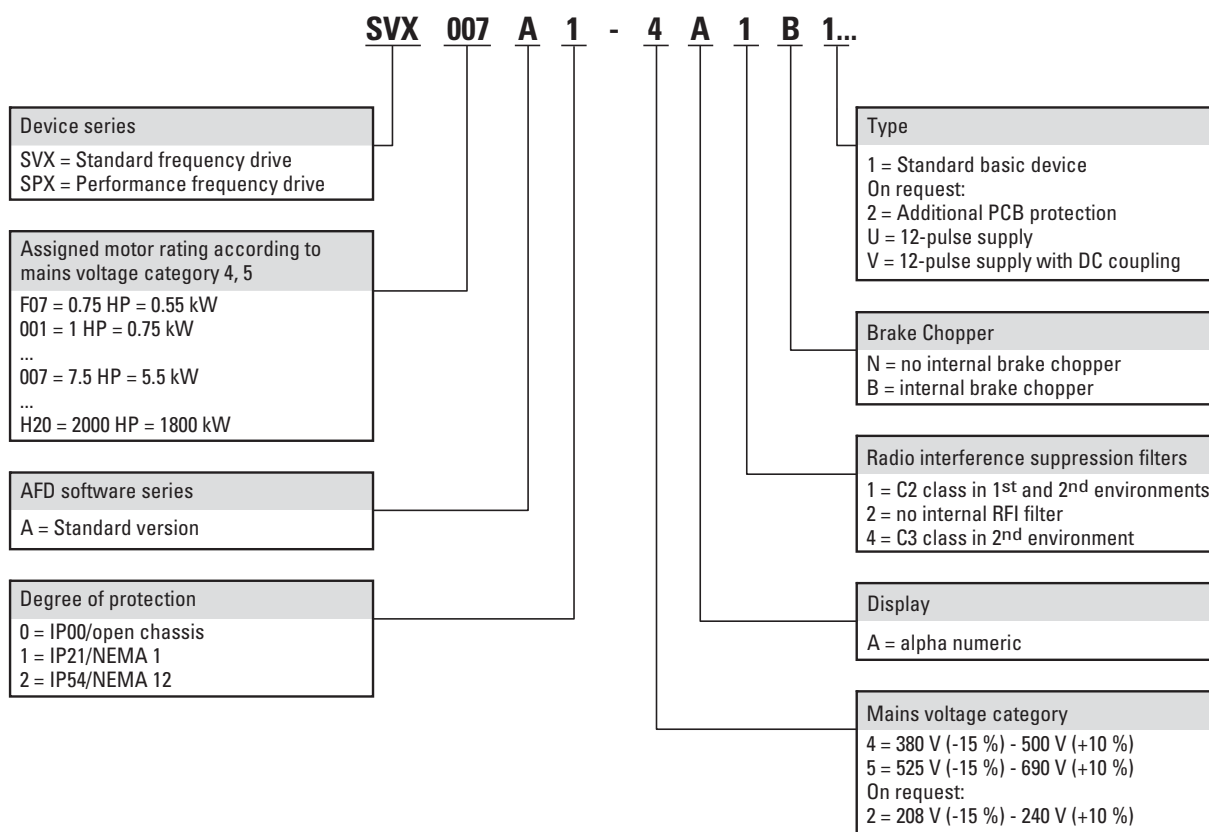

UL/CSA

Information relevant for export to North America



Product Standards	UL 508C; CSA-C22.2 No. 14; IEC/EN61800-3; IEC/EN61800-5; CE marking
UL File No.	E134360
UL Category Control No.	NMMS, NMMS2, NMMS7, NMMS8
CSA File No.	UL report applies to both US and Canada
CSA Class No.	3211-06
North America Certification	UL listed, certified by UL for use in Canada
Specially designed for North America	No
Suitable for	Branch circuits
Max. Voltage Rating	
SVX/SPX...-4...	3~ 480 V AC IEC: TN-S UL/CSA: "Y" (Solidly Grounded Wey)
SVX/SPX...-5...	3~ 690 V AC IEC: TN-S UL/CSA: "Y" (Solidly Grounded Wey)
Degree of Protection	
SPX...A0...	IEC: IP00
SVX/SPX...A1...	IEC: IP21
SVX/SPX...A2...	IEC: IP54

Ordering

Rated operational current ¹⁾	Assigned motor rating ^{1), 2), 3)}		Rated operational current ¹⁾	Assigned motor rating ^{1), 2), 3)}		Fitted with		Frame size	Degree of Protection	Part no. Article no.	Price see price list	Std. pack
	I _H = 150 % I _e A	I _H = 150 % P kW		I _H = 150 % P HP	I _L = 110 % I _e A	I _L = 110 % P kW	I _L = 110 % P HP					
U _e 400 V AC, 3-phase / U ₂ 400 V AC, 3-phase Mains voltage (50/60Hz) U _{LN} : 380 (-15%) - 500 (+10%) V												
2.2	0.75	1	3.3	1.1	1.5	✓	✓	FR4	IP21	SVX001A1-4A1B1 125676		1 off 
3.3	1.1	1.5	4.3	1.5	2	✓	✓			SVXF15A1-4A1B1 125707		
4.3	1.5	2	5.6	2.2	3	✓	✓			SVX002A1-4A1B1 125748		
5.6	2.2	3	7.6	3	5	✓	✓			SVX003A1-4A1B1 125679		
7.6	3	5	9	4	5	✓	✓			SVX005A1-4A1B1 125749		
9	4	5	12	5.5	7.5	✓	✓			SVX006A1-4A1B1 125682		
12	5.5	7.5	16	7.5	10	✓	✓	FR5	SVX007A1-4A1B1 125684			
16	7.5	10	23	11	15	✓	✓		SVX010A1-4A1B1 125686			
23	11	15	31	15	20	✓	✓		SVX015A1-4A1B1 125688			
31	15	20	38	18.5	25	✓	✓	FR6	SVX020A1-4A1B1 125690			
38	18.5	25	46	22	30	✓	✓		SVX025A1-4A1B1 125691			
46	22	30	61	30	40	✓	✓	SVX030A1-4A1B1 125693	FR7	SVX040A1-4A1N1 125695		
61	30	40	72	37	50	✓	-	SVX040A1-4A1B1 132656				
72	37	50	87	45	60	✓	✓	SVX050A1-4A1B1 138430				
87	45	60	105	55	75	✓	-	SVX050A1-4A1N1 125750				
105	55	75	140	75	100	✓	✓	SVX060A1-4A1B1 138431				
140	75	100	170	90	125	✓	-	SVX060A1-4A1N1 125751				
170	90	125	205	110	150	✓	✓	FR8	SVX075A1-4A1N1 125699			
205	110	150	261	132	200	✓	-		SVX075A1-4A1B1 132657			
245	132	200	300	160	250	✓	-	FR9	SVX100A1-4A1N1 125701			
						✓	✓		SVX100A1-4A1B1 132658			
						✓	-		SVX125A1-4A1N1 125702			
						✓	✓	SVX125A1-4A1B1 135242	FR9	SVX150A1-4A1N1 125704		
						✓	✓	SVX150A1-4A1B1 138432				
						✓	-	SVX200A1-4A1N1 125752	FR9	SVX200A1-4A1B1 132900		
						✓	✓	SVX200A1-4A1B1 132900				

Notes

¹⁾ Overload cycle for 60 s every 600 s

²⁾ for normal internally and externally ventilated 4 pole, three-phase asynchronous motors with 1500 rpm⁻¹ at 50 Hz or 1800 min⁻¹ at 60 Hz

³⁾ at 400 V, 50 Hz/at 440 - 480 V, 60 Hz



Information relevant for export to North America → Page 77

Rated operational current ¹⁾	Assigned motor rating ^{1), 2), 3)}		Rated operational current ¹⁾	Assigned motor rating ^{1), 2), 3)}		Fitted with Radio interference suppression filter Brake chopper	Frame size	Degree of Protection	Part no. Article no.	Price see price list	Std. pack
	I _H = 150 % I _e A	I _H = 150 % P kW		I _H = 150 % P HP	I _L = 110 % I _e A						
U_e 600 V AC, 3-phase / U₂ 600 V AC, 3-phase Mains voltage (50/60Hz) U _{LN} : 525 (-15%) - 690 (±10%) V											
3.2	2.2	2	4.5	3	3	✓ - ✓ ✓	FR6	IP21	SVX002A1-5A4N1 125756	1 off 	
						✓ ✓			SVX002A1-5A4B1 138480		
4.5	3	3	5.5	4	5	✓ - ✓ ✓			SVX003A1-5A4N1 125757		
						✓ ✓			SVX003A1-5A4B1 138481		
5.5	4	5	7.5	5.5	5	✓ - ✓ ✓			SVX004A1-5A4N1 125758		
						✓ ✓			SVX004A1-5A4B1 138482		
7.5	5.5	5	10	7.5	7.5	✓ - ✓ ✓			SVX005A1-5A4N1 125759		
						✓ ✓			SVX005A1-5A4B1 138483		
10	7.5	7.5	13.5	11	10	✓ - ✓ ✓			SVX007A1-5A4N1 125760		
						✓ ✓			SVX007A1-5A4B1 138484		
13.5	11	10	18	15	15	✓ - ✓ ✓	SVX010A1-5A4N1 125761				
						✓ ✓	SVX010A1-5A4B1 138485				
18	15	15	22	18.5	20	✓ - ✓ ✓	SVX015A1-5A4N1 125762				
						✓ ✓	SVX015A1-5A4B1 138486				
22	18.5	20	27	22	25	✓ - ✓ ✓	SVX020A1-5A4N1 125763				
						✓ ✓	SVX020A1-5A4B1 138487				
27	22	25	34	30	30	✓ - ✓ ✓	SVX025A1-5A4N1 125764				
						✓ ✓	SVX025A1-5A4B1 138488				
34	30	30	41	37	40	✓ - ✓ ✓	SVX030A1-5A4N1 125765				
						✓ ✓	SVX030A1-5A4B1 138489				
41	37	40	52	45	50	✓ - ✓ ✓	SVX040A1-5A4N1 125766				
						✓ ✓	SVX040A1-5A4B1 138490				
52	45	50	62	55	60	✓ - ✓ ✓	SVX050A1-5A4N1 125767				
						✓ ✓	SVX050A1-5A4B1 138491				
62	55	60	80	75	75	✓ - ✓ ✓	SVX060A1-5A4N1 125768				
						✓ ✓	SVX060A1-5A4B1 138492				
80	75	75	100	90	100	✓ - ✓ ✓	SVX075A1-5A4N1 125769				
						✓ ✓	SVX075A1-5A4B1 138493				

Notes

- ¹⁾ Overload cycle for 60 s every 600 s
- ²⁾ for normal internally and externally ventilated 4 pole, three-phase asynchronous motors with 1500 rpm⁻¹ at 50 Hz or 1800 min⁻¹ at 60 Hz
- ³⁾ at 690 V, 50 Hz/at 690 V, 60 Hz

Information relevant for export to North America → Page 77

SVX/SPX

Rated operational current ¹⁾	Assigned motor rating ^{1), 2), 3)}		Rated operational current ¹⁾	Assigned motor rating ^{1), 2), 3)}		Fitted with	Frame size	Degree of Protection	Part no. Article no.	Price see price list	Std. pack
$I_H = 150\%$ I_e A	$I_H = 150\%$ P kW	$I_H = 150\%$ P HP	$I_L = 110\%$ I_e A	$I_L = 110\%$ P kW	$I_L = 110\%$ P HP	Radio interference suppression filter Brake chopper					
U_e 600 V AC, 3-phase / U₂ 600 V AC, 3-phase											
Mains voltage (50/60Hz) U _{LN} : 525 (-15%) - 690 (±10%) V											
100	90	100	125	110	125	✓ - ✓ ✓	FR9	IP21	SVX100A1-5A4N1 125770		1 off 
									SVX100A1-5A4B1 138494		
125	110	125	144	132	150	✓ - ✓ ✓			SVX125A1-5A4N1 125771		
									SVX125A1-5A4B1 138495		
144	132	150	170	160	200	✓ - ✓ ✓			SVX150A1-5A4N1 125772		
									SVX150A1-5A4B1 138496		
170	160	200	208	200	200	✓ - ✓ ✓			SVX175A1-5A4N1 125773		
									SVX175A1-5A4B1 138497		

Notes

¹⁾ Overload cycle for 60 s every 600 s

²⁾ for normal internally and externally ventilated 4 pole, three-phase asynchronous motors with 1500 rpm⁻¹ at 50 Hz or 1800 min⁻¹ at 60 Hz

³⁾ at 690 V, 50 Hz/at 690 V, 60 Hz



Information relevant for export to North America → Page 77

Rated operational current ¹⁾	Assigned motor rating ^{1), 2), 3)}		Rated operational current ¹⁾	Assigned motor rating ^{1), 2), 3)}		Fitted with		Frame size	Degree of Protection	Part no. Article no.	Price see price list	Std. pack
	$I_H = 150\%$ I_e A	$I_H = 150\%$ P kW		$I_H = 150\%$ P HP	$I_L = 110\%$ I_e A	$I_L = 110\%$ P kW	$I_L = 110\%$ P HP					
U_g 400 V AC, 3-phase / U_2 400 V AC, 3-phase Mains voltage (50/60Hz) U_{LN} : 380 (-15%) - 500 (+10%) V												
2.2	0.75	1	3.3	1.1	1.5	✓	✓	FR4	IP54	SVX001A2-4A1B1 125677	1 off 	
3.3	1.1	1.5	4.3	1.5	2	✓	✓			SVXF15A2-4A1B1 125708		
4.3	1.5	2	5.6	2.2	3	✓	✓			SVX002A2-4A1B1 125678		
5.6	2.2	3	7.6	3	5	✓	✓			SVX003A2-4A1B1 125680		
7.6	3	5	9	4	5	✓	✓			SVX005A2-4A1B1 125753		
9	4	5	12	5.5	7.5	✓	✓			SVX006A2-4A1B1 125683		
12	5.5	7.5	16	7.5	10	✓	✓	FR5	SVX007A2-4A1B1 125685			
16	7.5	10	23	11	15	✓	✓		SVX010A2-4A1B1 125687			
23	11	15	31	15	20	✓	✓		SVX015A2-4A1B1 125689			
31	15	20	38	18.5	25	✓	✓	FR6	SVX020A2-4A1B1 125754			
38	18.5	25	46	22	30	✓	✓		SVX025A2-4A1B1 125692			
46	22	30	61	30	40	✓	✓		SVX030A2-4A1B1 125694			
61	30	40	72	37	50	✓	-	FR7	SVX040A2-4A1N1 125696			
						✓	✓		SVX040A2-4A1B1 138452			
72	37	50	87	45	60	✓	-		SVX050A2-4A1N1 125697			
						✓	✓		SVX050A2-4A1B1 138453			
87	45	60	105	55	75	✓	-		SVX060A2-4A1N1 125698			
						✓	✓		SVX060A2-4A1B1 138454			
105	55	75	140	75	100	✓	-	FR8	SVX075A2-4A1N1 125700			
						✓	✓		SVX075A2-4A1B1 138455			
140	75	100	170	90	125	✓	-		SVX100A2-4A1N1 125755			
						✓	✓	SVX100A2-4A1B1 138456				
170	90	125	205	110	150	✓	-	FR9	SVX125A2-4A1N1 125703			
						✓	✓		SVX125A2-4A1B1 138457			
205	110	150	261	132	200	✓	-		SVX150A2-4A1N1 125705			
						✓	✓	SVX150A2-4A1B1 138458				
245	132	200	300 300	160	250	✓	-	FR9	SVX200A2-4A1N1 125706			
						✓	✓		SVX200A2-4A1B1 138459			

Notes

¹⁾ Overload cycle for 60 s every 600 s

²⁾ for normal internally and externally ventilated 4 pole, three-phase asynchronous motors with 1500 rpm⁻¹ at 50 Hz or 1800 min⁻¹ at 60 Hz

³⁾ at 400 V, 50 Hz/at 440 - 480 V, 60 Hz

 Information relevant for export to North America → Page 77

SVX/SPX

Rated operational current ¹⁾	Assigned motor rating ^{1), 2), 3)}		Rated operational current ¹⁾	Assigned motor rating ^{1), 2), 3)}		Fitted with	Frame size	Degree of Protection	Part no. Article no.	Price see price list	Std. pack	
$I_H = 150\%$ I_e A	$I_H = 150\%$ P kW	$I_H = 150\%$ P HP	$I_L = 110\%$ I_e A	$I_L = 110\%$ P kW	$I_L = 110\%$ P HP	Radio interference suppression filter Brake chopper						
U_e 600 V AC, 3-phase / U_2 600 V AC, 3-phase Mains voltage (50/60Hz) U_{LN} : 525 (-15%) - 690 ($\pm 10\%$) V												
3.2	2.2	2	4.5	3	3	✓ - ✓ ✓	FR6	IP54	SVX002A2-5A4N1 125774		1 off 	
						✓ ✓			SVX002A2-5A4B1 138498			
4.5	3	3	5.5	4	5	✓ - ✓ ✓			SVX003A2-5A4N1 125775			SVX003A2-5A4B1 138499
5.5	4	5	7.5	5.5		✓ - ✓ ✓			SVX004A2-5A4N1 125776			SVX004A2-5A4B1 138500
7.5	5.5		10	7.5	7.5	✓ - ✓ ✓			SVX005A2-5A4N1 125777			SVX005A2-5A4B1 138501
10	7.5	7.5	13.5	11	10	✓ - ✓ ✓			SVX007A2-5A4N1 125778			SVX007A2-5A4B1 138502
13.5	11	10	18	15	15	✓ - ✓ ✓			SVX010A2-5A4N1 125779			SVX010A2-5A4B1 138503
18	15	15	22	18.5	20	✓ - ✓ ✓			SVX015A2-5A4N1 125780			SVX015A2-5A4B1 138504
22	18.5	20	27	22	25	✓ - ✓ ✓			SVX020A2-5A4N1 125781			SVX020A2-5A4B1 138505
27	22	25	34	30	30	✓ - ✓ ✓			SVX025A2-5A4N1 125782			SVX025A2-5A4B1 138506
34	30	30	41	37	40	✓ - ✓ ✓	FR7	SVX030A2-5A4N1 125783	SVX030A2-5A4B1 138507			
41	37	40	52	45	50	✓ - ✓ ✓		SVX040A2-5A4N1 125784	SVX040A2-5A4B1 138508			
52	45	50	62	55	60	✓ - ✓ ✓	FR8	SVX050A2-5A4N1 125785	SVX050A2-5A4B1 138509			
62	55	60	80	75	75	✓ - ✓ ✓		SVX060A2-5A4N1 125786	SVX060A2-5A4B1 138510			
80	75	75	100	90	100	✓ - ✓ ✓		SVX075A2-5A4N1 125787	SVX075A2-5A4B1 138511			

Notes

- ¹⁾ Overload cycle for 60 s every 600 s
- ²⁾ for normal internally and externally ventilated 4 pole, three-phase asynchronous motors with 1500 rpm⁻¹ at 50 Hz or 1800 min⁻¹ at 60 Hz
- ³⁾ at 690 V, 50 Hz/at 690 V, 60 Hz



 Information relevant for export to North America → Page 77



Rated operational current ¹⁾	Assigned motor rating ^{1), 2), 3)}		Rated operational current ¹⁾	Assigned motor rating ^{1), 2), 3)}		Fitted with	Frame size	Degree of Protection	Part no. Article no.	Price see price list	Std. pack
$I_H = 150\%$ I_e A	$I_H = 150\%$ P kW	$I_H = 150\%$ P HP	$I_L = 110\%$ I_e A	$I_L = 110\%$ P kW	$I_L = 110\%$ P HP	Radio interference suppression filter Brake chopper					
U_e 600 V AC, 3-phase / U_2 600 V AC, 3-phase Mains voltage (50/60Hz) U_{LN} : 525 (-15%) - 690 ($\pm 10\%$) V											
100	90	100	125	110	125	✓ - ✓ ✓	FR9	IP54	SVX100A2-5A4N1 125788		1 off
									SVX100A2-5A4B1 138512		
125	110	125	144	132	150	✓ - ✓ ✓			SVX125A2-5A4N1 125789		
									SVX125A2-5A4B1 138513		
144	132	150	170	160	200	✓ - ✓ ✓			SVX150A2-5A4N1 125790		
									SVX150A2-5A4B1 138514		
170	160	200	208	200	200	✓ - ✓ ✓			SVX175A2-5A4N1 125791		
									SVX175A2-5A4B1 138515		

Notes

- ¹⁾ Overload cycle for 60 s every 600 s
- ²⁾ for normal internally and externally ventilated 4 pole, three-phase asynchronous motors with 1500 rpm⁻¹ at 50 Hz or 1800 min⁻¹ at 60 Hz
- ³⁾ at 690 V, 50 Hz/at 690 V, 60 Hz

Information relevant for export to North America → Page 77

Rated operational current ¹⁾	Assigned motor rating ^{1), 2), 3)}		Rated operational current ¹⁾	Assigned motor rating ^{1), 2), 3)}		Fitted with		Frame size	Degree of Protection	Part no. Article no.	Price see price list	Std. pack
	I _H = 150 % I _e A	I _H = 150 % P kW		I _H = 150 % P HP	I _L = 110 % I _e A	I _L = 110 % P kW	I _L = 110 % P HP					
U _e 400 V AC, 3-phase / U ₂ 400 V AC, 3-phase												
Mains voltage (50/60Hz) U _{LN} : 380 (-15%) - 500 (+10%) V												
2.2	0.75	1	3.3	1.1	1.5	✓	✓	FR4	IP21	SPX001A1-4A1B1	125203	1 off  
3.3	1.1	1.5	4.3	1.5	2	✓	✓			SPXF15A1-4A1B1	125675	
4.3	1.5	2	5.6	2.2	3	✓	✓			SPX002A1-4A1B1	125657	
5.6	2.2	3	7.6	3	5	✓	✓			SPX003A1-4A1B1	125658	
7.6	3	5	9	4	6	✓	✓			SPX005A1-4A1B1	125659	
9	4	5	12	5.5	7.5	✓	✓			SPX006A1-4A1B1	125249	
12	5.5	7.5	16	7.5	10	✓	✓	FR5	SPX007A1-4A1B1	125660		
16	7.5	10	23	11	15	✓	✓		SPX010A1-4A1B1	125661		
23	11	15	31	15	20	✓	✓		SPX015A1-4A1B1	125663		
31	15	20	38	18.5	25	✓	✓	FR6	SPX020A1-4A1B1	125665		
38	18.5	25	46	22	30	✓	✓		SPX025A1-4A1B1	125666		
46	22	30	61	30	40	✓	✓	FR7	SPX030A1-4A1B1	125667		
61	30	40	72	37	50	✓	-		SPX040A1-4A1N1	125319		
						✓	✓		SPX040A1-4A1B1	134844		
72	37	50	87	45	60	✓	-		SPX050A1-4A1N1	125331		
						✓	✓		SPX050A1-4A1B1	138606		
87	45	60	105	55	75	✓	-		SPX060A1-4A1N1	125668		
						✓	✓	SPX060A1-4A1B1	138607			
105	55	75	140	75	100	✓	-	FR8	SPX075A1-4A1N1	125354		
						✓	✓		SPX075A1-4A1B1	138608		
140	75	100	170	90	125	✓	-	FR9	SPX100A1-4A1N1	125365		
						✓	✓		SPX100A1-4A1B1	131744		
170	90	125	205	110	150	✓	-	FR9	SPX125A1-4A1N1	125669		
						✓	✓		SPX125A1-4A1B1	134489		
205	110	150	261	132	200	✓	-	FR9	SPX150A1-4A1N1	125381		
						✓	✓		SPX150A1-4A1B1	129701		
245	132	200	300	160	250	✓	-	FR9	SPX200A1-4A1N1	125670		
						✓	✓		SPX200A1-4A1B1	134845		

Notes¹⁾ Overload cycle for 60 s every 600 s²⁾ for normal internally and externally ventilated 4 pole, three-phase asynchronous motors with 1500 rpm⁻¹ at 50 Hz or 1800 min⁻¹ at 60 Hz³⁾ at 400 V, 50 Hz/at 440 - 480 V, 60 Hz  Information relevant for export to North America → Page 77

Rated operational current ¹⁾	Assigned motor rating ^{1), 2), 3)}		Rated operational current ¹⁾	Assigned motor rating ^{1), 2), 3)}		Fitted with		Frame size	Degree of Protection	Part no. Article no.	Price see price list	Std. pack		
	$I_H = 150\%$ I_e A	$I_H = 150\%$ P kW		$I_H = 150\%$ P HP	$I_L = 110\%$ I_e A	$I_L = 110\%$ P kW	$I_L = 110\%$ P HP						Radio interference suppression filter	Brake chopper
U_e 400 V AC, 3-phase / U_2 400 V AC, 3-phase Mains voltage (50/60Hz) U_{LN} : 380 (-15%) - 500 (+10%) V														
300	160	250	385	200	300	✓	✓	FR10	IP21	SPX250A1-4A4B1		1 off		
						✓	-							SPX250A1-4A4N1
385	200	300	460	250	350	✓	-							SPX300A1-4A4N1
460	250	350	520			✓	-							SPX350A1-4A4N1
520	250	400	590	315	500	✓	-			FR11				SPX400A1-4A4N1
590	315	500	650	355	550	✓	-							
650	355	550	730	400	600	✓	-				SPX550A1-4A4N1			
300	160	250	385	200	300	-	✓	FR10	IP00	SPX250A0-4A2B1				
						-	-							SPX250A0-4A2N1
385	200	300	460	250	350	-	✓							SPX300A0-4A2B1
460	250	350	520			-	✓							SPX350A0-4A2B1
520		400	590	315	500	-	✓			FR11				SPX400A0-4A2B1
590	315	500	650	355	550	-	✓							
650	355	550	730	400	600	-	✓				SPX550A0-4A2B1			
730	400	600	820	450	650	-	✓	FR12		SPX600A0-4A2B1				
820	450	650	920	500	700	-	-				SPX650A0-4A2N1			
920	500	700	1030	560	800	-	-				SPX700A0-4A2N1			
1030	560	800	1150	630	900	-	-	FR13		SPX800A0-4A2N1				
1150	630	900	1300	710	1000	-	-				SPX900A0-4A2N1			
1300	710	1000	1450	800	1200	-	-				SPXH10A0-4A2N1			
1600	900	1200	1770	1000	1600	-	-	FR14		SPXH12A0-4A2N1				
1940	1100	1600	2150	1200	2000	-	-				SPXH16A0-4A2N1			

Notes

- ¹⁾ Overload cycle for 60 s every 600 s
- ²⁾ for normal internally and externally ventilated 4 pole, three-phase asynchronous motors with 1500 rpm⁻¹ at 50 Hz or 1800 min⁻¹ at 60 Hz
- ³⁾ at 400 V, 50 Hz/at 440 - 480 V, 60 Hz

Information relevant for export to North America → Page 77

SVX/SPX

Rated operational current ¹⁾	Assigned motor rating 1), 2), 3)		Rated operational current ¹⁾	Assigned motor rating 1), 2), 3)		Fitted with Radio interference suppression filter Brake chopper	Frame size	Degree of Protection	Part no. Article no.	Price see price list	Std. pack
	$I_H = 150\%$ I_e A	$I_H = 150\%$ P kW		$I_H = 150\%$ P HP	$I_L = 110\%$ I_e A						
U_e 600 V AC, 3-phase / U₂ 600 V AC, 3-phase											
Mains voltage (50/60Hz) U _{L,N} : 525 (-15%) - 690 (±10%) V											
3.2	2.2	2	4.5	3	3	✓ - ✓ ✓	FR6	IP21	SPX002A1-5A4N1 125212		1 off 
						✓ ✓			SPX002A1-5A4B1 138638		
4.5	3	3	5.5	4	5	✓ - ✓ ✓			SPX003A1-5A4N1 125222		
						✓ ✓			SPX003A1-5A4B1 138639		
5.5	4	5	7.5	5.5		✓ - ✓ ✓			SPX004A1-5A4N1 125232		
						✓ ✓			SPX004A1-5A4B1 138640		
7.5	5.5		10	7.5	7.5	✓ - ✓ ✓			SPX005A1-5A4N1 125241		
						✓ ✓			SPX005A1-5A4B1 138641		
10	7.5	7.5	13.5	11	10	✓ - ✓ ✓			SPX007A1-5A4N1 125256		
						✓ ✓			SPX007A1-5A4B1 138642		
13.5	11	10	18	15	15	✓ - ✓ ✓	SPX010A1-5A4N1 125267				
						✓ ✓	SPX010A1-5A4B1 138643				
18	15	15	22	18.5	20	✓ - ✓ ✓	SPX015A1-5A4N1 125277				
						✓ ✓	SPX015A1-5A4B1 138644				
22	18.5	20	27	22	25	✓ - ✓ ✓	SPX020A1-5A4N1 125287				
						✓ ✓	SPX020A1-5A4B1 138645				
27	22	25	34	30	30	✓ - ✓ ✓	SPX025A1-5A4N1 125298				
						✓ ✓	SPX025A1-5A4B1 138646				
34	30	30	41	37	40	✓ - ✓ ✓	FR7	SPX030A1-5A4N1 125309			
						✓ ✓	SPX030A1-5A4B1 138647				
41	37	40	52	45	50	✓ - ✓ ✓	SPX040A1-5A4N1 125321				
						✓ ✓	SPX040A1-5A4B1 138648				
52	45	50	62	55	60	✓ - ✓ ✓	FR8	SPX050A1-5A4N1 125333			
						✓ ✓	SPX050A1-5A4B1 138649				
62	55	60	80	75	75	✓ - ✓ ✓	SPX060A1-5A4N1 125344				
						✓ ✓	SPX060A1-5A4B1 138650				
80	75	75	100	90	100	✓ - ✓ ✓	SPX075A1-5A4N1 125356				
						✓ ✓	SPX075A1-5A4B1 138651				

Notes





¹⁾ Overload cycle for 60 s every 600 s

²⁾ for normal internally and externally ventilated 4 pole, three-phase asynchronous motors with 1500 rpm⁻¹ at 50 Hz or 1800 min⁻¹ at 60 Hz

³⁾ at 690 V, 50 Hz/at 690 V, 60 Hz



Information relevant for export to North America → Page 77



Rated operational current ¹⁾	Assigned motor rating 1), 2), 3)		Rated operational current ¹⁾	Assigned motor rating 1), 2), 3)		Fitted with Radio interference suppression filter Brake chopper	Frame size	Degree of Protection	Part no. Article no.	Price see price list	Std. pack
	I _H = 150 % I _e A	I _H = 150 % P kW		I _H = 150 % P HP	I _L = 110 % I _e A						
U_B 690 V AC, 3-phase / U₂ 690 V AC, 3-phase Mains voltage (50/60Hz) U _{LN} : 525 (-15%) - 690 (±10%) V											
100	90	100	125	110	125	✓ - ✓ ✓	FR9	IP21	SPX100A1-5A4N1 125367 SPX100A1-5A4B1 138652 SPX125A1-5A4N1 125375 SPX125A1-5A4B1 138653 SPX150A1-5A4N1 125383 SPX150A1-5A4B1 138654 SPX175A1-5A4N1 125389 SPX175A1-5A4B1 138655		1 off  
125	110	125	144	132	150	✓ - ✓ ✓					
144	132	150	170	160	200	✓ - ✓ ✓					
170	160	200	208	200		✓ - ✓ ✓					
208	200		261	250	300	✓ -	FR10		SPX200A1-5A4N1 125396 SPX250A1-5A4N1 125407		
261	250	250	325	315		✓ -					
325	315	300	385	355	400	✓ -	FR11		SPX300A1-5A4N1 125417 SPX400A1-5A4N1 125434 SPX450A1-5A4N1 125438 SPX500A1-5A4N1 125446		
385	355	400	460	450	450	✓ -					
460	450	450	502	500	500	✓ -					
502	500	500	590	560	600	✓ -					
208	200	200	261	250	300	- -	FR10	IP00	SPX200A0-5A2N1 129600 SPX250A0-5A2N1 129602		1 off  
261	250	250	325	315		- -					
325	315	300	385	355	400	- -	FR11		SPX300A0-5A2N1 129604 SPX400A0-5A2N1 129607 SPX450A0-5A2N1 129608 SPX500A0-5A2N1 129610		
385	355	400	460	450	450	- -					
460	450	450	502	500	500	- -					
502	500	500	590	560	600	- -					
590	560	600	650	630	750	- -	FR12		SPX550A0-5A2N1 129612 SPX600A0-5A2N1 129614		
650	630		750	710	850	- -					
750	710	850	820	800		- -	FR13		SPX700A0-5A2N1 129617 SPX800A0-5A2N1 129618 SPX900A0-5A2N1 129619		
820	800		920	900	1100	- -					
920	900	1100	1030	1000		- -					
1030	1000		1180	1150	1300	- -					
1300	1300	1300	1500	1500		- -	FR14		SPXH10A0-5A2N1 129620 SPXH13A0-5A2N1 129621 SPXH15A0-5A2N1 129622 SPXH20A0-5A2N1 129623		
1500	1500		1900	1800		- -					
1900	1800		2250	2000		- -					

Notes

¹⁾ Overload cycle for 60 s every 600 s

²⁾ for normal internally and externally ventilated 4 pole, three-phase asynchronous motors with 1500 rpm⁻¹ at 50 Hz or 1800 min⁻¹ at 60 Hz

³⁾ at 690 V, 50 Hz/at 690 V, 60 Hz

  Information relevant for export to North America → Page 77

SVX/SPX

Rated operational current ¹⁾	Assigned motor rating ^{1), 2), 3)}		Rated operational current ¹⁾	Assigned motor rating ^{1), 2), 3)}		Fitted with		Frame size	Degree of Protection	Part no. Article no.	Price see price list	Std. pack		
	I _H = 150 % I _e A	I _H = 150 % P kW		I _H = 150 % P HP	I _L = 110 % I _e A	I _L = 110 % P kW	I _L = 110 % P HP						Radio interference suppression filter	Brake chopper
U_e 400 V AC, 3-phase / U₂ 400 V AC, 3-phase Mains voltage (50/60Hz) U _{LN} : 380 (-15%) - 500 (+10%) V														
2.2	0.75	1	3.3	1.1	1.5	✓	✓	FR4	IP54	SPX001A2-4A1B1		1 off 		
													125207	
3.3	1.1	1.5	4.3	1.5	2	✓	✓						SPXF15A2-4A1B1	
													125480	
4.3	1.5	2	5.6	2.2	3	✓	✓						SPX002A2-4A1B1	
													125216	
5.6	2.2	3	7.6	3	5	✓	✓			SPX003A2-4A1B1				
										125226				
7.6	3	5	9	4	6	✓	✓			SPX005A2-4A1B1				
										125245				
9	4	5	12	5.5	7.5	✓	✓			SPX006A2-4A1B1				
										125251				
12	5.5	7.5	16	7.5	10	✓	✓	FR5		SPX007A2-4A1B1				
											125260			
16	7.5	10	23	11	15	✓	✓				SPX010A2-4A1B1			
										125662				
23	11	15	31	15	20	✓	✓			SPX015A2-4A1B1				
										125664				
31	15	20	38	18.5	25	✓	✓	FR6		SPX020A2-4A1B1				
											125291			
38	18.5	25	46	22	30	✓	✓			SPX025A2-4A1B1				
										125302				
46	22	30	61	30	40	✓	✓			SPX030A2-4A1B1				
										125313				
61	30	40	72	37	50	✓	-	FR7		SPX040A2-4A1N1				
						✓	✓				125325			
72	37	50	87	45	60	✓	-			SPX040A2-4A1B1				
						✓	✓			138609				
87	45	60	105	55	75	✓	-			SPX050A2-4A1N1				
						✓	✓			125337				
105	55	75	140	75	100	✓	-	FR8		SPX050A2-4A1B1				
						✓	✓				138610			
140	75	100	170	90	125	✓	-			SPX060A2-4A1N1				
						✓	✓			125348				
170	90	125	205	110	150	✓	-			SPX060A2-4A1B1				
						✓	✓			138611				
205	110	150	261	132	200	✓	-	FR9		SPX075A2-4A1N1				
			261			✓	✓				125359			
245	132	200	300	160	250	✓	-			SPX075A2-4A1B1				
						✓	✓			138612				
300	160	250	385	200	300	✓	-	FR10		SPX100A2-4A1N1				
						✓	✓				125370			
385	200	300	460	250	350	✓	-			SPX100A2-4A1B1				
						✓	✓			138613				
460	250	350	520			✓	-			SPX125A2-4A1N1				
						✓	✓			125377				
										SPX125A2-4A1B1				
										138614				
										SPX150A2-4A1N1				
										125385				
										SPX150A2-4A1B1				
										138615				
										SPX200A2-4A1N1				
										125398				
										SPX200A2-4A1B1				
										138616				
										SPX250A2-4A4N1				
										125672				
										SPX300A2-4A4N1				
										125419				
										SPX350A2-4A4N1				
										125426				

Notes

¹⁾ Overload cycle for 60 s every 600 s

²⁾ for normal internally and externally ventilated 4 pole, three-phase asynchronous motors with 1500 rpm⁻¹ at 50 Hz or 1800 min⁻¹ at 60 Hz

³⁾ at 400 V, 50 Hz/at 440 - 480 V, 60 Hz

 Information relevant for export to North America → Page 77

Rated operational current ¹⁾	Assigned motor rating ^{1), 2), 3)}		Rated operational current ¹⁾	Assigned motor rating ^{1), 2), 3)}		Fitted with Radio interference suppression filter Brake chopper	Frame size	Degree of Protection	Part no. Article no.	Price see price list	Std. pack
	$I_H = 150\%$ I_e A	$I_H = 150\%$ P kW		$I_H = 150\%$ P HP	$I_L = 110\%$ I_e A						
U_e 600 V AC, 3-phase / U_e 600 V AC, 3-phase Mains voltage (50/60Hz) U_{LN} : 525 (-15%) - 690 ($\pm 10\%$) V											
3.2	2.2	2	4.5	3	3	✓ - ✓ ✓	FR6	IP54	SPX002A2-5A4N1 125218		1 off
						✓ ✓			SPX002A2-5A4B1 129582		
4.5	3	3	5.5	4	5	✓ - ✓ ✓			SPX003A2-5A4N1 125228		
						✓ ✓			SPX003A2-5A4B1 129583		
5.5	4	5	7.5	5.5		✓ ✓ ✓ -			SPX004A2-5A4B1 129584		
						✓ -			SPX004A2-5A4N1 125236		
7.5	5.5		10	7.5	7.5	✓ - ✓ ✓			SPX005A2-5A4N1 125247		
						✓ ✓			SPX005A2-5A4B1 129585		
10	7.5	7.5	13.5	11	10	✓ - ✓ ✓			SPX007A2-5A4N1 125262		
						✓ ✓			SPX007A2-5A4B1 129586		
13.5	11	10	18	15	15	✓ - ✓ ✓	SPX010A2-5A4N1 125272				
						✓ ✓	SPX010A2-5A4B1 129587				
18	15	15	22	18.5	20	✓ - ✓ ✓	SPX015A2-5A4N1 125282				
						✓ ✓	SPX015A2-5A4B1 129588				
22	18.5	20	27	22	25	✓ - ✓ ✓	SPX020A2-5A4N1 125293				
						✓ ✓	SPX020A2-5A4B1 129589				
27	22	25	34	30	30	✓ - ✓ ✓	SPX025A2-5A4N1 125304				
						✓ ✓	SPX025A2-5A4B1 129590				
34	30	30	41	37	40	✓ - ✓ ✓	FR7 SPX030A2-5A4N1 125315				
						✓ ✓	SPX030A2-5A4B1 129591				
41	37	40	52	45	50	✓ - ✓ ✓	SPX040A2-5A4N1 125327				
						✓ ✓	SPX040A2-5A4B1 129592				
52	45	50	62	55	60	✓ - ✓ ✓	FR8 SPX050A2-5A4N1 125339				
						✓ ✓	SPX050A2-5A4B1 129593				
62	55	60	80	75	75	✓ - ✓ ✓	SPX060A2-5A4N1 125350				
						✓ ✓	SPX060A2-5A4B1 129594				
80	75	75	100	90	100	✓ - ✓ ✓	SPX075A2-5A4N1 125361				
						✓ ✓	SPX075A2-5A4B1 129595				

Notes

- ¹⁾ Overload cycle for 60 s every 600 s
- ²⁾ for normal internally and externally ventilated 4 pole, three-phase asynchronous motors with 1500 rpm⁻¹ at 50 Hz or 1800 min⁻¹ at 60 Hz
- ³⁾ at 690 V, 50 Hz/at 690 V, 60 Hz













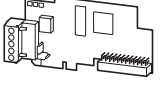

Information relevant for export to North America → Page 77

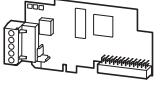

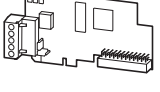
SVX/SPX

Rated operational current ¹⁾	Assigned motor rating ^{1), 2), 3)}		Rated operational current ¹⁾	Assigned motor rating ^{1), 2), 3)}		Fitted with	Frame size	Degree of Protection	Part no. Article no.	Price see price list	Std. pack
$I_H = 150\%$ I_e A	$I_H = 150\%$ P kW	$I_H = 150\%$ P HP	$I_L = 110\%$ I_e A	$I_L = 110\%$ P kW	$I_L = 110\%$ P HP	Radio interference suppression filter Brake chopper					
U_e 600 V AC, 3-phase / U₂ 600 V AC, 3-phase											
Mains voltage (50/60Hz) U _{LN} : 525 (-15%) - 690 (±10%) V											
100	90	100	125	110	125	✓ - ✓ ✓	FR9	IP54	SPX100A2-5A4N1 125372		1 off 
									SPX100A2-5A4B1 129596		
125	110	125	144	132	150	✓ - ✓ ✓			SPX125A2-5A4N1 125379		
									SPX125A2-5A4B1 129597		
144	132	150	170	160	200	✓ - ✓ ✓			SPX150A2-5A4N1 125387		
									SPX150A2-5A4B1 129598		
170	160	200	208	200		✓ - ✓ ✓			SPX175A2-5A4N1 125391		
									SPX175A2-5A4B1 129599		
208	200		261	250	300	✓ -	FR10		SPX200A2-5A4N1 125400		
261	250	250	325	315		✓ -			SPX250A2-5A4N1 125410		
325	315	300	385	355	400	✓ -			SPX300A2-5A4N1 125421		

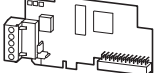
Notes¹⁾ Overload cycle for 60 s every 600 s²⁾ for normal internally and externally ventilated 4 pole, three-phase asynchronous motors with 1500 rpm⁻¹ at 50 Hz or 1800 min⁻¹ at 60 Hz³⁾ at 690 V, 50 Hz/at 690 V, 60 Hz**Information relevant for export to North America → Page 77**

Accessories

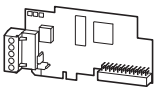
Description	For use with	Part no. Article no.	Price see price list	Std. pack	Information relevant for export to North America 
External keypad					
With illuminated LCD display Plain text, multi-line With control buttons and function keys Front IP54	SVX, SPX	KEYPAD-LOC/REM 139787		1 off 	Product Standards UL 508C; CSA-C22.2 No. 14; IEC/EN61800-3; IEC/EN61800-5; CE marking E134360 UL File No. UL Category Control No. NMMS, NMMS2, NMMS7, NMMS8 UL report applies to both US and Canada CSA File No. North America Certification UL listed, certified by UL for use in Canada Branch circuits Suitable for
External keypad					
Mounting frame for control panel door 2 m	KEYPAD- LOC/REM	OPTRMT-KIT 126868		1 off 	
Connection cable					
Connection between variable frequency drive and PC 1.5 m	SVX, SPX	SVDRIVCABLE 129001		1 off 	
Expansion modules					
The expansion module is plugged into the variable-frequency drive.					
Adapters					
	System bus adapter	SPX	OPTD1 125077	1 off 	
	System bus adapter with CANopen® interface	SPX	OPTD2 125078		
	RS232 adapter	SPX	OPTD3 125079		
Output expansion					
	1 relay output (NO/NC) 1 relay output (NC) 1 Thermistor input	SPX	OPTA3 125050	1 off 	
	2 relay outputs (NO/NC)	SVX, SPX	OPTA2 125049		
	1 relay output (NO) 5 digital inputs (42 - 240 V AC)	SVX, SPX	OPTB9 125064		
	3 relay outputs (NO)	SVX, SPX	OPTB5 125062		
	1 relay output (NO/NC) 1 relay output (NO) 1 Thermistor input	SVX, SPX	OPTB2 125060		
I/O expansion					
	6 digital inputs External 24 V supply	SVX, SPX	OPTB1 125059	1 off 	
	6 digital inputs 1 digital output 2 analog inputs (mA/V) 1 analog output	SVX, SPX	OPTA9 125055		
	3 digital inputs 1 relay output (NO/NC) 1 digital output	SVX, SPX	OPTAA 125056		
	6 digital inputs 1 digital output 2 analog inputs (mA/V) 1 analog output	SPX	OPTA8 125054		
	1 analog input (mA, isolated) 2 analog outputs (mA, isolated)	SVX, SPX	OPTB4 125061		
Encoder module					
	HTL (+15 V/24 V) Master / Slave capability	SPX	OPTA7 125053	1 off 	
Temperature sensor expansion					
	3 Pt100 External 24 V supply	SVX, SPX	OPTB8 125063	1 off 	

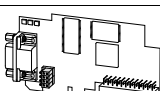
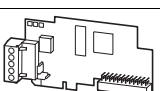
Description	For use with	Part no. Article no.	Price see price list	Std. pack	Information relevant for export to North America 
Fieldbus modules					
The field bus module is plugged into the variable-frequency drive.					
	Modbus RS485 Screw terminals	SVX, SPX	OPTC2 125067	1 off 	Product Standards UL 508C; CSA-C22.2 No. 14; IEC/EN61800-3; IEC/EN61800-5; CE marking UL File No. E134360 UL Category Control No. NMMS, NMMS2, NMMS7, NMMS8 CSA File No. UL report applies to both US and Canada North America Certification UL listed, certified by UL for use in Canada Suitable for Branch circuits
	PROFIBUS-DP Screw terminals	SVX, SPX	OPTC3 125068		
	LonWorks Screw terminals	SVX, SPX	OPTC4 125069		
	CANopen® Screw terminals	SVX, SPX	OPTC6 125710		
	PROFIBUS-DP SUB-D 9 pole, socket	SVX, SPX	OPTC5 125070		
	DeviceNet SUB-D 9 pole, socket	SVX, SPX	OPTC7 125071		
	Modbus RS485 SUB-D 9 pole, socket	SVX, SPX	OPTC8 125072		
	Modbus TCP RJ45, 8-pole	SVX, SPX	OPTCI 125075		
	BACnet MS/TP Screw terminals	SVX, SPX	OPTCJ 125076		

Part no.	Motor		Frequency inverters		Power Wiring	Motor feeder		Sine filter	
	Assigned motor rating		Rated operational current		Main choke	motor choke			
	$I_H = 150\%$	$I_L = 110\%$	$I_H = 150\%$	$I_L = 110\%$	$I_H = 150\%$ (CT/ I_H , at 50 °C)	$I_H = 150\%$ (CT/ I_H , at 50 °C)	$I_L = 110\%$ (VT/ I_L , at 40 °C)	$I_H = 150\%$ (CT/ I_H , at 50 °C)	$I_L = 110\%$ (VT/ I_L , at 40 °C)
P	P	I_e	I_e						
kW	kW	A	A						

SVX variable frequency drive

400 V AC, 3-phase/400 V AC, 3-phase

SVX001A1-4...	0.75	1.1	2.2	3.3	DX-LN3-004	DX-LM3-005	DX-LM3-005	DX-SIN3-004	DX-SIN3-004
SVXF15A1-4...	1.1	1.5	3.3	4.3	DX-LN3-006	DX-LM3-005	DX-LM3-005	DX-SIN3-004	DX-SIN3-010
SVX002A1-4...	1.5	2.2	4.3	5.6	DX-LN3-006	DX-LM3-005	DX-LM3-008	DX-SIN3-010	DX-SIN3-010
SVX003A1-4...	2.2	3	5.6	7.6	DX-LN3-010	DX-LM3-008	DX-LM3-008	DX-SIN3-010	DX-SIN3-010
SVX005A1-4...	3	4	7.6	9	DX-LN3-010	DX-LM3-008	DX-LM3-011	DX-SIN3-010	DX-SIN3-010
SVX006A1-4...	4	5.5	9	12	DX-LN3-016	DX-LM3-011	DX-LM3-016	DX-SIN3-010	DX-SIN3-016
SVX007A1-4...	5.5	7.5	12	16	DX-LN3-016	DX-LM3-016	DX-LM3-016	DX-SIN3-016	DX-SIN3-016
SVX010A1-4...	7.5	11	16	23	DX-LN3-025	DX-LM3-016	DX-LM3-035	DX-SIN3-016	DX-SIN3-023
SVX015A1-4...	11	15	23	31	DX-LN3-040	DX-LM3-035	DX-LM3-035	DX-SIN3-023	DX-SIN3-032
SVX020A1-4...	15	18.5	31	38	DX-LN3-040	DX-LM3-035	DX-LM3-050	DX-SIN3-032	DX-SIN3-048
SVX025A1-4...	18.5	22	38	46	DX-LN3-050	DX-LM3-050	DX-LM3-050	DX-SIN3-048	DX-SIN3-048
SVX030A1-4...	22	30	46	61	DX-LN3-080	DX-LM3-050	DX-LM3-063	DX-SIN3-048	DX-SIN3-061
SVX040A1-4...	30	37	61	72	DX-LN3-080	DX-LM3-063	DX-LM3-080	DX-SIN3-061	DX-SIN3-072
SVX050A1-4...	37	45	72	87	DX-LN3-100	DX-LM3-080	DX-LM3-100	DX-SIN3-072	DX-SIN3-090
SVX060A1-4...	45	55	87	105	DX-LN3-120	DX-LM3-100	DX-LM3-150	DX-SIN3-090	DX-SIN3-115
SVX075A1-4...	55	75	105	140	DX-LN3-160	DX-LM3-150	DX-LM3-150	DX-SIN3-115	DX-SIN3-150
SVX100A1-4...	75	90	140	170	DX-LN3-200	DX-LM3-150	DX-LM3-180	DX-SIN3-150	DX-SIN3-180
SVX125A1-4...	90	110	170	205	DX-LN3-250	DX-LM3-180	DX-LM3-220	DX-SIN3-180	DX-SIN3-250
SVX150A1-4...	110	132	205	261	DX-LN3-300	DX-LM3-220	DX-LM3-260	DX-SIN3-250	DX-SIN3-440
SVX200A1-4...	132	160	245	300	DX-LN3-300	DX-LM3-260	DX-LM3-303	DX-SIN3-250	DX-SIN3-440

690 V AC, 3-phase/690 V AC, 3-phase

SVX002A1-5...	2.2	3	3.2	4.5	DX-LN3-006	DX-LM3-005	DX-LM3-005	SIN-0005-6-0-P	SIN-0005-6-0-P
SVX003A1-5...	3	4	4.5	5.5	DX-LN3-006	DX-LM3-005	DX-LM3-008	SIN-0008-6-0-P	SIN-0008-6-0-P
SVX004A1-5...	4	5.5	5.5	7.5	DX-LN3-010	DX-LM3-008	DX-LM3-008	SIN-0008-6-0-P	SIN-0008-6-0-P
SVX005A1-5...	5.5	7.5	7.5	10	DX-LN3-010	DX-LM3-008	DX-LM3-011	SIN-0014-6-0-P	SIN-0014-6-0-P
SVX007A1-5...	7.5	11	10	13.5	DX-LN3-016	DX-LM3-011	DX-LM3-016	SIN-0014-6-0-P	SIN-0014-6-0-P
SVX010A1-5...	11	15	13.5	18	DX-LN3-025	DX-LM3-016	DX-LM3-035	SIN-0023-6-0-P	SIN-0023-6-0-P
SVX015A1-5...	15	18.5	18	22	DX-LN3-025	DX-LM3-035	DX-LM3-035	SIN-0023-6-0-P	SIN-0023-6-0-P
SVX020A1-5...	18.5	22	22	27	DX-LN3-040	DX-LM3-035	DX-LM3-035	SIN-0035-6-0-P	SIN-0035-6-0-P
SVX025A1-5...	22	30	27	34	DX-LN3-040	DX-LM3-035	DX-LM3-035	SIN-0035-6-0-P	SIN-0035-6-0-P
SVX030A1-5...	30	37	34	41	DX-LN3-050	DX-LM3-035	DX-LM3-050	SIN-0052-6-0-P	SIN-0052-6-0-P
SVX040A1-5...	37	45	41	52	DX-LN3-080	DX-LM3-050	DX-LM3-063	SIN-0052-6-0-P	SIN-0052-6-0-P
SVX050A1-5...	45	55	52	62	DX-LN3-080	DX-LM3-063	DX-LM3-063	SIN-0085-6-0-P	SIN-0085-6-0-P
SVX060A1-5...	55	75	62	80	DX-LN3-080	DX-LM3-063	DX-LM3-080	SIN-0085-6-0-P	SIN-0085-6-0-P
SVX075A1-5...	75	90	80	100	DX-LN3-100	DX-LM3-080	DX-LM3-100	SIN-0122-6-0-P	SIN-0122-6-0-P
SVX100A1-5...	90	110	100	125	DX-LN3-160	DX-LM3-100	DX-LM3-150	SIN-0122-6-0-P	SIN-0185-6-0-P
SVX125A1-5...	110	132	125	144	DX-LN3-160	DX-LM3-150	DX-LM3-150	SIN-0185-6-0-P	SIN-0185-6-0-P
SVX150A1-5...	132	160	144	170	DX-LN3-200	DX-LM3-150	DX-LM3-180	SIN-0185-6-0-P	SIN-0185-6-0-P
SVX175A1-5...	160	200	170	208	DX-LN3-250	DX-LM3-180	DX-LM3-220	SIN-0287-6-0-P	SIN-0287-6-0-P

SPX variable frequency drive

400 V AC, 3-phase/400 V AC, 3-phase

SPX001A1-4...	0.75	1.1	2.2	3.3	DX-LN3-004	DX-LM3-005	DX-LM3-005	DX-SIN3-004	DX-SIN3-004
SPXF15A1-4...	1.1	1.5	3.3	4.3	DX-LN3-006	DX-LM3-005	DX-LM3-005	DX-SIN3-004	DX-SIN3-010
SPX002A1-4...	1.5	2.2	4.3	5.6	DX-LN3-006	DX-LM3-005	DX-LM3-008	DX-SIN3-010	DX-SIN3-010
SPX003A1-4...	2.2	3	5.6	7.6	DX-LN3-010	DX-LM3-008	DX-LM3-008	DX-SIN3-010	DX-SIN3-010
SPX005A1-4...	3	4	7.6	9	DX-LN3-010	DX-LM3-008	DX-LM3-011	DX-SIN3-010	DX-SIN3-010
SPX006A1-4...	4	5.5	9	12	DX-LN3-016	DX-LM3-011	DX-LM3-016	DX-SIN3-010	DX-SIN3-016
SPX007A1-4...	5.5	7.5	12	16	DX-LN3-016	DX-LM3-016	DX-LM3-016	DX-SIN3-016	DX-SIN3-016
SPX010A1-4...	7.5	11	16	23	DX-LN3-025	DX-LM3-016	DX-LM3-035	DX-SIN3-016	DX-SIN3-023
SPX015A1-4...	11	15	23	31	DX-LN3-040	DX-LM3-035	DX-LM3-035	DX-SIN3-023	DX-SIN3-032
SPX020A1-4...	15	18.5	31	38	DX-LN3-040	DX-LM3-035	DX-LM3-050	DX-SIN3-032	DX-SIN3-048
SPX025A1-4...	18.5	22	38	46	DX-LN3-050	DX-LM3-050	DX-LM3-050	DX-SIN3-048	DX-SIN3-048
SPX030A1-4...	22	30	46	61	DX-LN3-080	DX-LM3-050	DX-LM3-063	DX-SIN3-048	DX-SIN3-061
SPX040A1-4...	30	37	61	72	DX-LN3-080	DX-LM3-063	DX-LM3-080	DX-SIN3-061	DX-SIN3-072
SPX050A1-4...	37	45	72	87	DX-LN3-100	DX-LM3-080	DX-LM3-100	DX-SIN3-072	DX-SIN3-090

Part no.	Motor		Frequency inverters		Power Wiring Main choke	Motor feeder motor choke		Sine filter		
	Assigned motor rating		Rated operational current			I _H = 150 % (CT/I _H , at 50 °C)	I _H = 150 % (CT/I _H , at 50 °C)	I _L = 110 % (VT/I _L , at 40 °C)	I _H = 150 % (CT/I _H , at 50 °C)	I _L = 110 % (VT/I _L , at 40 °C)
	I _H = 150 %	I _L = 110 %	I _H = 150 %	I _L = 110 %						
P	P	I _e	I _e							
kW	kW	A	A							
SPX060A1-4...	45	55	87	105	DX-LN3-120 ¹⁾	DX-LM3-100	DX-LM3-150	DX-SIN3-090	DX-SIN3-115	
SPX075A1-4...	55	75	105	140	DX-LN3-160 ¹⁾	DX-LM3-150	DX-LM3-150	DX-SIN3-115	DX-SIN3-150	
SPX100A1-4...	75	90	140	170	DX-LN3-200 ¹⁾	DX-LM3-150	DX-LM3-180	DX-SIN3-150	DX-SIN3-180	
SPX125A1-4...	90	110	170	205	DX-LN3-250 ¹⁾	DX-LM3-180	DX-LM3-220	DX-SIN3-180	DX-SIN3-250	
SPX150A1-4...	110	132	205	261	DX-LN3-300 ¹⁾	DX-LM3-220	DX-LM3-260	DX-SIN3-250	DX-SIN3-440	
SPX200A1-4...	132	160	245	300	DX-LN3-300	DX-LM3-260	DX-LM3-303	DX-SIN3-250	DX-SIN3-440	
SPX250A0-4...	160	200	300	385	On request	DX-LM3-303	DX-LM3-450	DX-SIN3-440	DX-SIN3-440	
SPX300A0-4...	200	250	385	460	On request	DX-LM3-450	DUT-0590-6-0-S	DX-SIN3-440	DX-SIN3-480	
SPX350A0-4...	250	250	460	520	-	DUT-0590-6-0-S	DUT-0590-6-0-S	SIN-0600-5-0-P	SIN-0600-5-0-P	
SPX400A0-4...	250	315	520	590	-	DUT-0590-6-0-S	DUT-0590-6-0-S	SIN-0600-5-0-P	SIN-0600-5-0-P	
SPX500A0-4...	315	355	590	650	-	DUT-0820-6-0-S	DUT-0820-6-0-S	SIN-0600-5-0-P	SIN-0840-5-0-P	
SPX550A0-4...	355	400	650	730	-	DUT-0820-6-0-S	DUT-1100-6-0-S	SIN-0840-5-0-P	SIN-0840-5-0-P	
SPX600A0-4...	400	450	730	820	-	DUT-1250-6-0-S	DUT-1100-6-0-S	SIN-0840-5-0-P	SIN-0840-5-0-P	
SPX650A0-4...	450	500	820	920	-	DUT-1250-6-0-S	DUT-1100-6-0-S	SIN-1160-5-0-P	SIN-1160-5-0-P	
SPX700A0-4...	500	560	920	1030	-	DUT-1250-6-0-S	DUT-1100-6-0-S	SIN-1160-5-0-P	SIN-1160-5-0-P	
SPX800A0-4...	560	630	1030	1150	-	DUT-1250-6-0-S	DUT-1250-6-0-S	SIN-1480-5-0-P	SIN-1160-5-0-P	
SPX900A0-4...	630	710	1150	1300	-	DUT-1600-6-0-S	DUT-1600-6-0-S	SIN-1480-5-0-P	SIN-1480-5-0-P	
SPXH10A0-4...	710	800	1300	1450	-	DUT-1600-6-0-S	DUT-1600-6-0-S	SIN-1480-5-0-P	SIN-1480-5-0-P	
SPXH12A0-4...	900	1000	1600	1770	-	-	-	-	-	
SPXH16A0-4...	1100	1200	1940	2150	-	-	-	-	-	
690 V AC, 3-phase/690 V AC, 3-phase										
SPX002A1-5...	2.2	3	3.2	4.5	DX-LN3-006	DX-LM3-005	DX-LM3-005	SIN-0005-6-0-P	SIN-0005-6-0-P	
SPX003A1-5...	3	4	4.5	5.5	DX-LN3-006	DX-LM3-008	DX-LM3-008	SIN-0008-6-0-P	SIN-0008-6-0-P	
SPX004A1-5...	4	5.5	5.5	7.5	DX-LN3-010	DX-LM3-008	DX-LM3-008	SIN-0008-6-0-P	SIN-0008-6-0-P	
SPX005A1-5...	5.5	7.5	7.5	10	DX-LN3-010	DX-LM3-011	DX-LM3-011	SIN-0014-6-0-P	SIN-0014-6-0-P	
SPX007A1-5...	7.5	11	10	13.5	DX-LN3-016	DX-LM3-016	DX-LM3-016	SIN-0014-6-0-P	SIN-0014-6-0-P	
SPX010A1-5...	11	15	13.5	18	DX-LN3-025	DX-LM3-035	DX-LM3-035	SIN-0023-6-0-P	SIN-0023-6-0-P	
SPX015A1-5...	15	18.5	18	22	DX-LN3-025	DX-LM3-035	DX-LM3-035	SIN-0023-6-0-P	SIN-0023-6-0-P	
SPX020A1-5...	18.5	22	22	27	DX-LN3-040	DX-LM3-035	DX-LM3-035	SIN-0035-6-0-P	SIN-0035-6-0-P	
SPX025A1-5...	22	30	27	34	DX-LN3-040	DX-LM3-035	DX-LM3-035	SIN-0035-6-0-P	SIN-0035-6-0-P	
SPX030A1-5...	30	37	34	41	DX-LN3-050	DX-LM3-035	DX-LM3-050	SIN-0052-6-0-P	SIN-0052-6-0-P	
SPX040A1-5...	37	45	41	52	DX-LN3-080	DX-LM3-050	DX-LM3-063	SIN-0052-6-0-P	SIN-0052-6-0-P	
SPX050A1-5...	45	55	52	62	DX-LN3-080	DX-LM3-063	DX-LM3-063	SIN-0085-6-0-P	SIN-0085-6-0-P	
SPX060A1-5...	55	75	62	80	DX-LN3-080	DX-LM3-063	DX-LM3-080	SIN-0085-6-0-P	SIN-0085-6-0-P	
SPX075A1-5...	75	90	80	100	DX-LN3-100	DX-LM3-080	DX-LM3-100	SIN-0122-6-0-P	SIN-0122-6-0-P	
SPX100A1-5...	90	110	100	125	DX-LN3-160	DX-LM3-100	DX-LM3-150	SIN-0122-6-0-P	SIN-0185-6-0-P	
SPX125A1-5...	110	132	125	144	DX-LN3-160	DX-LM3-150	DX-LM3-150	SIN-0185-6-0-P	SIN-0185-6-0-P	
SPX150A1-5...	132	160	144	170	DX-LN3-200	DX-LM3-150	DX-LM3-180	SIN-0185-6-0-P	SIN-0185-6-0-P	
SPX175A1-5...	160	200	170	208	DX-LN3-250	DX-LM3-180	DX-LM3-220	SIN-0287-6-0-P	SIN-0287-6-0-P	
SPX200A0-5...	200	250	208	261	DX-LN3-300	DX-LM3-220	DX-LM3-303	SIN-0287-6-0-P	SIN-0287-6-0-P	
SPX250A0-5...	250	315	261	325	-	DX-LM3-260	DX-LM3-450	SIN-0390-6-0-P	SIN-0390-6-0-P	
SPX300A0-5...	315	355	325	385	-	DX-LM3-450	DX-LM3-450	SIN-0390-6-0-P	SIN-0390-6-0-P	
SPX400A0-5...	355	450	385	460	-	DX-LM3-450	DUT-0590-6-0-S	SIN-0460-6-0-P	SIN-0460-6-0-P	
SPX450A0-5...	450	500	460	502	-	DUT-0590-6-0-S	DUT-0590-6-0-S	SIN-0460-6-0-P	SIN-0620-6-0-P	
SPX500A0-5...	500	560	502	590	-	DUT-0590-6-0-S	DUT-0590-6-0-S	SIN-0620-6-0-P	SIN-0620-6-0-P	
SPX550A0-5...	560	630	590	650	-	DUT-0820-6-0-S	DUT-0820-6-0-S	SIN-0780-6-0-P	SIN-0780-6-0-P	
SPX600A0-5...	630	710	650	750	-	DUT-0820-6-0-S	DUT-0820-6-0-S	SIN-0780-6-0-P	SIN-0780-6-0-P	
SPX700A0-5...	710	800	750	820	-	DUT-1250-6-0-S	DUT-0820-6-0-S	SIN-0920-6-0-P	SIN-0920-6-0-P	
SPX800A0-5...	800	900	820	920	-	DUT-1250-6-0-S	DUT-1250-6-0-S	SIN-1180-6-0-P	SIN-0920-6-0-P	
SPX900A0-5...	900	1000	920	1030	-	DUT-1250-6-0-S	DUT-1250-6-0-S	SIN-1180-6-0-P	SIN-1180-6-0-P	
SPXH10A0-5...	1000	1150	1030	1180	-	DUT-1250-6-0-S	DUT-1250-6-0-S	SIN-1180-6-0-P	SIN-1180-6-0-P	
SPXH13A0-5...	1300	1500	1300	1500	-	DUT-1600-6-0-S	DUT-1600-6-0-S	-	-	
SPXH15A0-5...	1500	1800	1500	1900	-	-	-	-	-	
SPXH20A0-5...	1800	2000	1900	2250	-	-	-	-	-	

Notes

¹⁾ Mains choke recommended only if the power quality is poor. Current harmonics (THD) are attenuated by internal DC link chokes.



Soft Starter DS7 of System xStart – Soft at the Start, High on Torque

Soft starters have become a well-established alternative to the star-delta starter. This is where the DS7, featuring two-phase control and designed to work seamlessly with DILM and PKZ switchgear, comes in. The DS7 can be flexibly combined with other units and adds the ability to "start motors softly" to the switching, protection, and starting functions common to control panels. A patented method ensures that motor run-ups will be exceptionally soft while providing a higher torque than other available solutions. Longer service intervals and reduced operating costs are welcome side effects of this.

Designed for normal applications such as pumps, fans and small conveyors, the compact DS7 is ideal. The DS7 is also available with a SmartWire-DT connection to simplify wiring and enhance functionality as an automation solution.



System overview

DS7 soft starter < 32 A	98
DS7 soft starter > 32 A	100

Key to type references

DS7 soft starter	101
------------------	-----

Description

DS7 soft starter	102
------------------	-----

Ordering

DS7 soft starter	103
Accessories DS7	104

Engineering

General informationen on Engineering	108
Design with different load cycles	110
Connection examples	112
Assigned switching and protective elements DS7	114

System overview

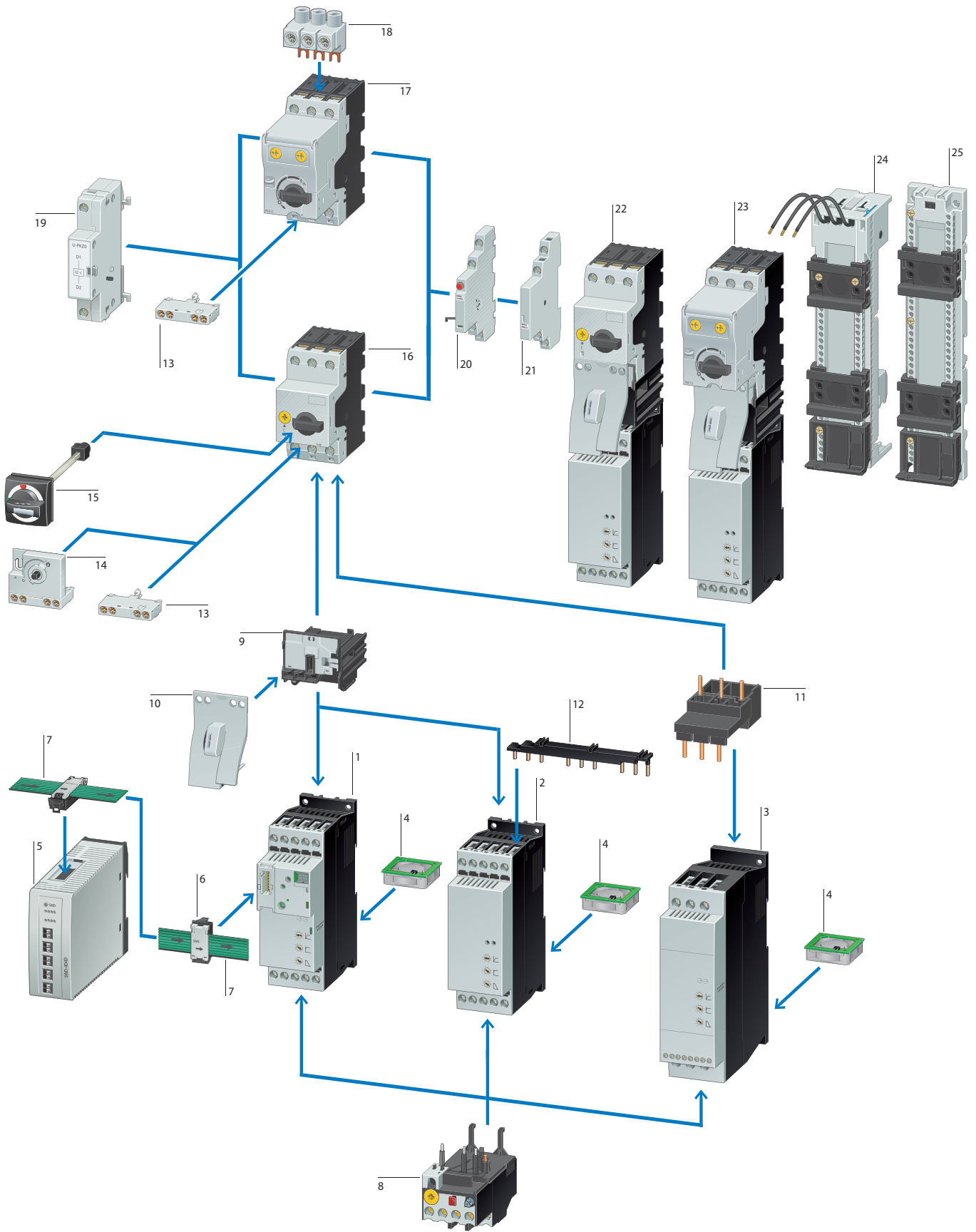

Soft starter DS7 with SmartWire-DT	1	Early-make auxiliary contact	14
→ page 103		→Industrial Switchgear catalog	
DS7 soft starters in construction size 1 for assigned motor current up to 12 A	2	Door coupling handle	15
→ page 103		→Industrial Switchgear catalog	
DS7 soft starters in construction size 2 for assigned motor current up to 32 A	3	PKZM0 motor-protective circuit-breakers	16
→ page 103		→Industrial Switchgear catalog	
DS7-FAN-32 device fan	4	PKE motor-protective circuit-breakers	17
→ page 107		→Industrial Switchgear catalog	
SmartWire-DT gateway	5	Connection clamp	18
→ page 148		→Industrial Switchgear catalog	
SmartWire-DT external device plug	6	voltage release	19
→ page 148		→Industrial Switchgear catalog	
SmartWire-DT flat band conductor	7	Indicator switch	20
→ page 148		→Industrial Switchgear catalog	
Overload relays	8	standard auxiliary contact	21
→ page 105		→Industrial Switchgear catalog	
PKZM0-XDM wiring set in tool-less plug connection	9, 10	Motor-starter combination with PKZ	22
→ page 105		→Industrial Switchgear catalog	
PKZM0-XM wiring set	11	Motor-starter combination with PKE	23
→ page 105		→Industrial Switchgear catalog	
three-phase commoning link	12	busbar adapter	24
→ page 106		→ page 105	
standard auxiliary contact	13	top-hat rail adapter	25
→Industrial Switchgear catalog		→ page 105	

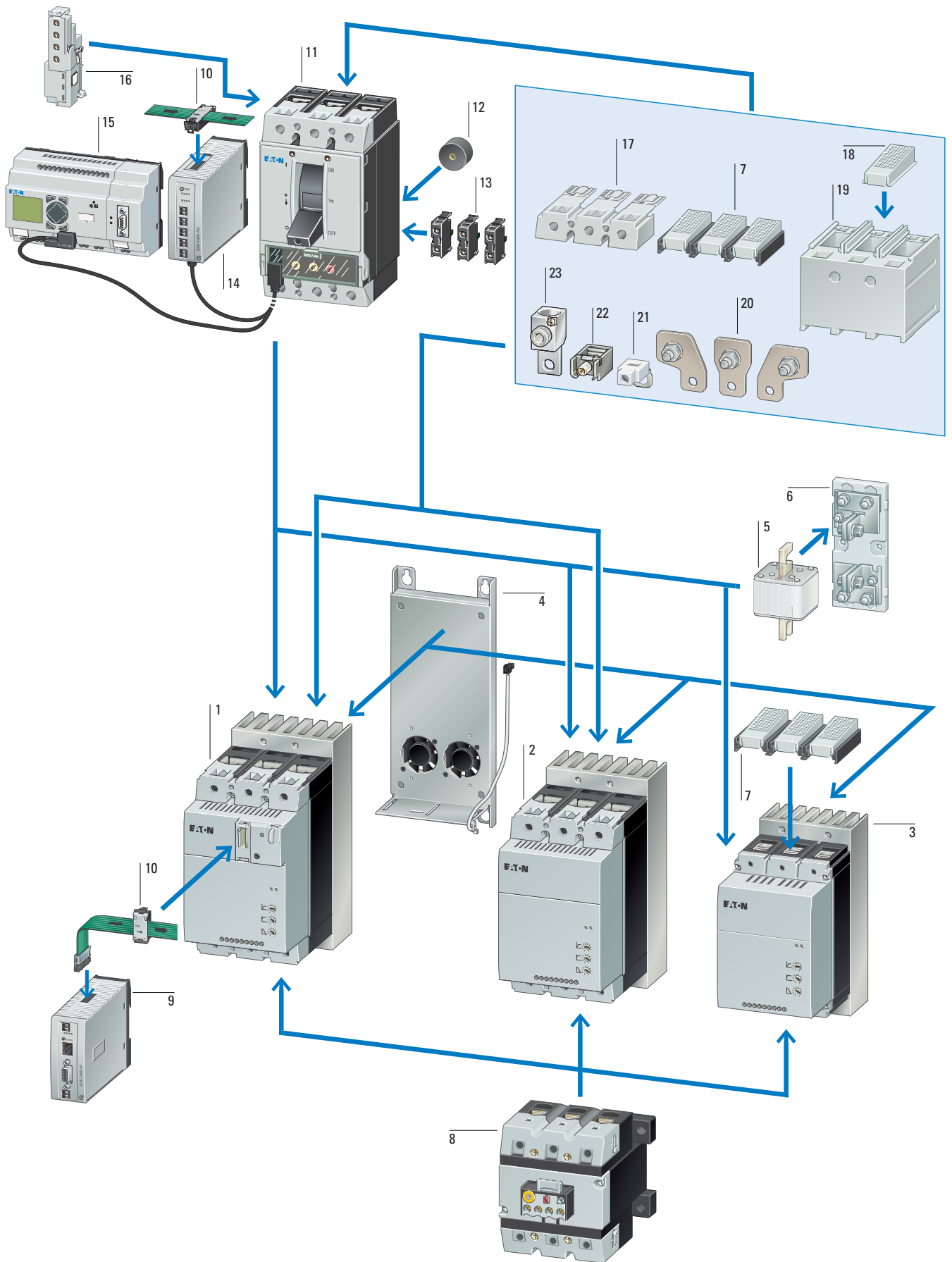

DS7 with SmartWire-DT	1
→ page 103	
DS7 size 4 up to 200 A	2
→ page 103	
DS7 size 3 up to 100 A	3
→ page 103	
Device fan	4
→ page 107	
Superfast semiconductor fuses	5
→ page 104	
Fuse bases for superfast semiconductor fuses	6
→ page 104	
IP2X protection against contact with a finger	7
→ page 107	
Overload relays	8
→ Industrial Switchgear catalog	
Gateways for SmartWire-DT	9
→ page 148	
SmartWire-DT external device plug	10
→ page 148	
NZM circuit-breaker	11
→ Industrial Switchgear catalog	

Spacer	12
→ Industrial Switchgear catalog	
Standard auxiliary contact/Trip-indicating auxiliary switch	13
→ Industrial Switchgear catalog	
NZM communication module for SmartWire-DT	14
→ Industrial Switchgear catalog	
Data management interface (DMI module)	15
→ Industrial Switchgear catalog	
Voltage release/Early-make auxiliary contact	16
→ Industrial Switchgear catalog	
Terminal cover for terminals	17
→ page 106	
IP2X protection against contact with a finger	18
→ page 107	
Terminal cover for cable lugs	19
→ page 106	
Connection width extension	20
→ Industrial Switchgear catalog	
Control circuit terminal	21
→ Industrial Switchgear catalog	
Box terminals	22
→ Industrial Switchgear catalog	
Tunnel terminals for Al and Cu cable	23
→ Industrial Switchgear catalog	

Key to type references

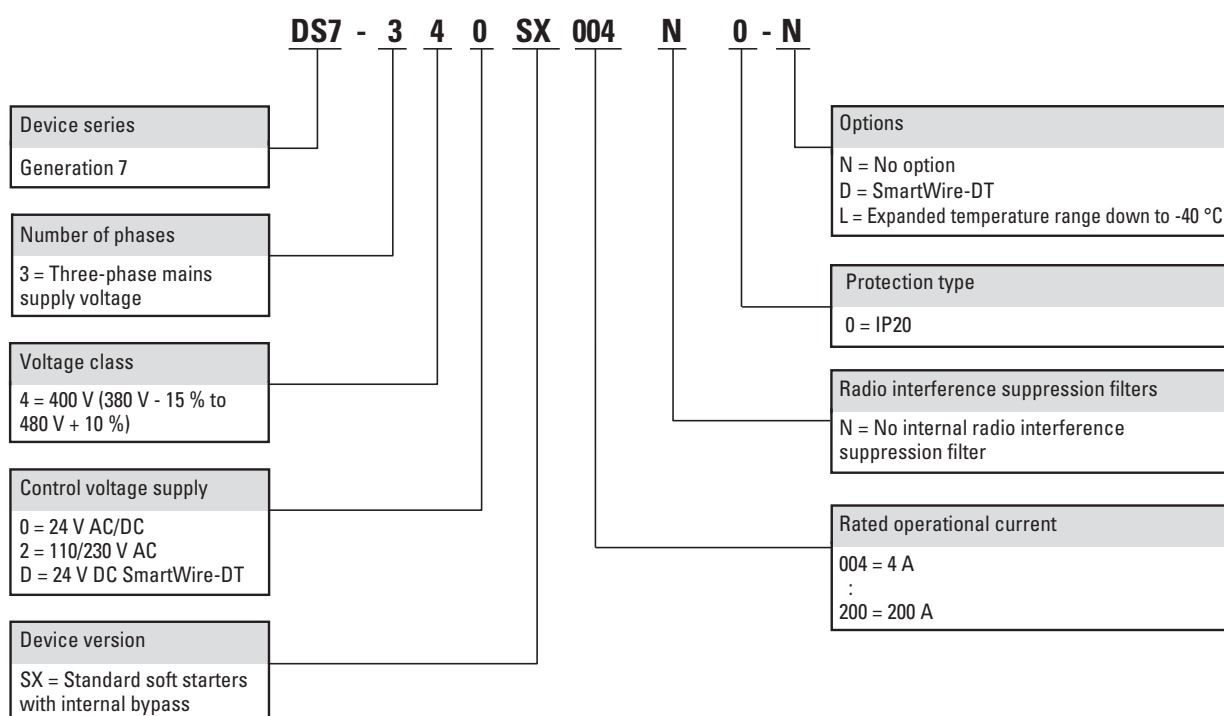

DS7

Description



Application

The DS7 series soft starters are two-phased controlled soft starters used for soft starting three-phase AC motors for applications with a normal operating frequency and a performance range of 3 to 200 A (1.1 to 110 kW with a 400 V mains voltage).

Closing transients and DC components during startup are effectively suppressed and guarantee even motor starting.

The special actuation method (asymmetrical trigger phase control) for the soft starter function avoids the DC components (Eaton patent) that would normally occur in two-phase-controlled soft starters. This suppresses the generation of an elliptical rotating field, which would cause uneven motor starting and increase the motor's acceleration. The true run behavior of the DS7 is therefore comparable with that of a three-phase controlled soft starter.

Functions

Typical fields of application for Series DS7 soft starters are:

- Pump drives: pressure surges are prevented through soft starting. The mechanical load on the whole plant is reduced and its service life increases.
- Fan drives: soft starting keeps fan belts from slipping, preventing premature wear. This lowers operating costs and extends the system's lifespan.
- Conveyor belts: conveyor belts start running smoothly, instead of starting with a jolt. This ensures that any goods being conveyed do not topple over. Mechanical damage to the belt itself is avoided, making it more durable.

Features

- The ramp time can be adjusted by potentiometer within a range of 1 to 30 s (for starting) or 0 to 30 s (for stopping) with a potentiometer
- The start voltage (or start torque) can be adjusted within a range of 30 to 100 percent of the mains voltage with a potentiometer
- Significant reduction in switch-on current, achieved with a short soft start ramp time (min. 1 s) for lamp and heating loads
- Internal bypass relay: switches on automatically after the end of the ramp, bypassing the internal thyristors.
- This makes it possible to comply with radio interference level B without any additional measures.
- The motor's thermal load is smaller than it would be without asymmetric ignition control.
- Designed specifically for long cables

Documentation

Surface mounting and standard mounting procedures are described in the corresponding mounting instructions and in the manual.

Instructional leaflets:
 IL03902003Z: for size 1 devices (up to 12 A motor output)
 IL03902004Z: for size 2 devices (up to 32 A motor output)
 IL03902005Z: for size 3, 4 devices (up to 200 A motor output)

Manual:
 MN03901001Z

You can download the documentation for the DS7 soft starters from the Internet at: www.moeller.net/support

Communication interface SmartWire-DT

Our SmartWire-DT interface completely eliminates the need for conventional control wiring. This has several advantages:

- No incorrect wiring
- Faster wiring
- Cost saving

The interface can be used to send control commands to the DS7-SWD and change and diagnose its parameter configuration; in addition, the control electronics can be powered via the SmartWire-DT cable. The device is controlled with one of three selectable profiles:

- A "start/stop" profile, which should already be familiar from the PKE motor-protective circuit-breaker and contactor combination
- An 8 bit-wide profile for the soft starter, which is provided the same way for the variable frequency drive and features more options
- A control profile comparable to a PROFIdrive profile, just like the one available for the variable frequency drive.

Regardless of the profile chosen, the DS7-SWD's parameters can be read and written to at any time by using acyclic services.

DS7-SWD makes it possible to read and write to all device parameters. The mechanisms of the parameter channel that is described for the drives in the PROFIdrive profile are used for this purpose. This profile provides a standardized parameter access method for variable frequency drives and soft starters.

It is also possible to overwrite the potentiometer settings on the DS7-SWD, which can come in handy, for instance, when a change made to the machine needs to be undone.

The DS7-SWD comes with a detailed diagnostic system with options that extend far beyond those of wired devices. In addition to having an error log, the DS7-SWD can detect and report nine different device faults. A warning parameter reports any present alarm messages. Moreover, the response to each individual fault can be customized. Finally, there are 35 additional messages for communication errors. Using the DS7 in connection with the PKE opens up new functionalities that were previously thought impossible to implement with a low-cost soft starter and that were reserved to significantly more expensive devices. Combining a PKE unit and a DS7-SWD makes it possible to completely protect the DS7-SWD device against overloads. In addition, it provides a current limiting function and can report thermal capacity utilization levels to higher level controllers.

Expanded temperature range

DS7-340SX...-L soft starters can operate at temperatures as low as -40 °C.

Ordering

Rated operational current	Assigned motor rating		Part no.	Article no.	Price see price list	Part no.	Article no.	Price see price list	Std. pack
AC-53	at 400 V, 50 Hz	at 460 V, 60 Hz	U _C 24 V AC/DC U _S 24 V AC/DC Standard temperature range			U _C 24 V AC/DC U _S 24 V AC/DC Expanded temperature range down to -40 °C			
I _e	P	P							
A	kW	HP							

Soft starters

Soft starters for three-phase loads
Mains supply voltage (50/60 Hz)
U_{LN} 200 - 480 V AC

4	1.5	2	DS7-340SX004NO-N	134847		DS7-340SX004NO-L	171740		1 off
7	3	5	DS7-340SX007NO-N	134849		DS7-340SX007NO-L	171741		
9	4	5	DS7-340SX009NO-N	134910		DS7-340SX009NO-L	171742		
12	5.5	10	DS7-340SX012NO-N	134911		DS7-340SX012NO-L	171743		
16	7.5	10	DS7-340SX016NO-N	134912		DS7-340SX016NO-L	171744		
24	11	15	DS7-340SX024NO-N	134913		DS7-340SX024NO-L	171745		
32	15	25	DS7-340SX032NO-N	134914		DS7-340SX032NO-L	171746		
41	22	30	DS7-340SX041NO-N	134916		DS7-340SX041NO-L	171747		
55	30	40	DS7-340SX055NO-N	134917		DS7-340SX055NO-L	171748		
70	37	50	DS7-340SX070NO-N	134918		DS7-340SX070NO-L	171749		
81	45	60	DS7-340SX081NO-N	134919		DS7-340SX081NO-L	171750		
100	55	75	DS7-340SX100NO-N	134920		DS7-340SX100NO-L	171751		
135	75	100	DS7-340SX135NO-N	134921		DS7-340SX135NO-L	171752		
160	90	125	DS7-340SX160NO-N	134922		DS7-340SX160NO-L	171753		
200	110	150	DS7-340SX200NO-N	134923		DS7-340SX200NO-L	171754		

U_C 110 - 230 V AC
U_S 110 - 230 V AC

U_C 24 V DC
U_S 24 V DC



4	1.5	2	DS7-342SX004NO-N	134925		DS7-34DSX004NO-D	134943		1 off
7	3	5	DS7-342SX007NO-N	134927		DS7-34DSX007NO-D	134945		
9	4	5	DS7-342SX009NO-N	134928		DS7-34DSX009NO-D	134946		
12	5.5	10	DS7-342SX012NO-N	134929		DS7-34DSX012NO-D	134947		
16	7.5	10	DS7-342SX016NO-N	134930		DS7-34DSX016NO-D	134948		
24	11	15	DS7-342SX024NO-N	134931		DS7-34DSX024NO-D	134949		
32	15	25	DS7-342SX032NO-N	134932		DS7-34DSX032NO-D	134950		
41	22	30	DS7-342SX041NO-N	134934		DS7-34DSX041NO-D	134952		
55	30	40	DS7-342SX055NO-N	134935		DS7-34DSX055NO-D	134953		
70	37	50	DS7-342SX070NO-N	134936		DS7-34DSX070NO-D	134954		
81	45	60	DS7-342SX081NO-N	134937		DS7-34DSX081NO-D	134955		
100	55	75	DS7-342SX100NO-N	134938		DS7-34DSX100NO-D	134956		
135	75	100	DS7-342SX135NO-N	134939		DS7-34DSX135NO-D	134957		
160	90	125	DS7-342SX160NO-N	134940		DS7-34DSX160NO-D	134958		
200	110	150	DS7-342SX200NO-N	134941		DS7-34DSX200NO-D	134959		

Notes

Information relevant for export to North America
UL/CSA applies only for DS7...-N

Product Standards IEC/EN 60947-4-2; GB 14048.6; UL 508;
CSA-C22.2 No 0-M91; CSA-C22.2 No 14-05
CE marking
UL File No. E251034
CSA File No. 2511305
CSA Class No. 321106
Suitable for Branch circuits
Max. Voltage Rating 480 V
Degree of Protection IP20; UL/CSA Type 1

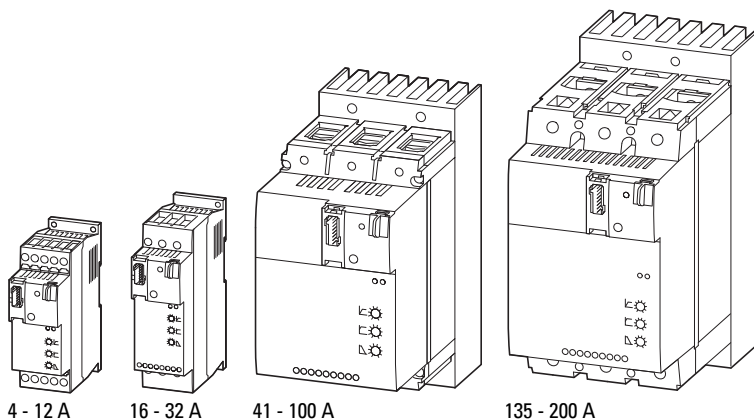







4 - 12 A

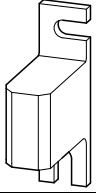

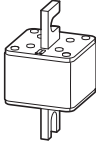

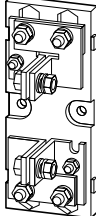

16 - 32 A



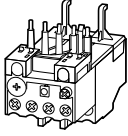

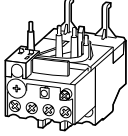



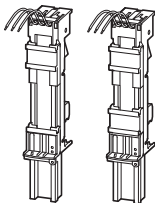
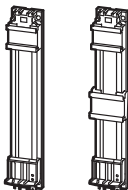



41 - 100 A

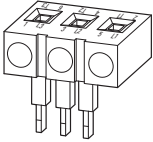



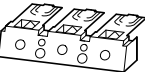

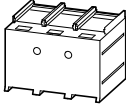
135 - 200 A

Rated device current	Maximum power loss P_v W	Frame size	For use with	Article no.	Price see price list	Std. pack	Information relevant for export to North America 	
Superfast semiconductor fuses								
DIN 43653, 690/700 V (IEC/UL) Inside micrometer 80 mm								
	16	5.5	000	DS7-34...SX004N0-...	170M1359	10 off 	Product Standards IEC/EN 60269-4; UL 248-1; CSA-C22.2 No. 248.14; CE marking E125085 UL File No. UL Category Control No. JFHR2 CSA File No. 053787_C_000 CSA Class No. 1422-30 North America Certification Suitable for UL recognized, CSA certified semiconductor protection	
	25	9	000	DS7-34...SX007N0-...	170M1361			
	32	10	000	DS7-34...SX009N0-... DS7-34...SX012N0-...	170M1362			
	50	15	000	DS7-34...SX016N0-...	170M1364			
	63	16	000	DS7-34...SX024N0-...	170M1365			
	80	19	000	DS7-34...SX032N0-...	170M1366			
		125	26	S1*	DS7-34...SX041N0-... DS7-34...SX055N0-...			170M3013
		200	45	S1	DS7-34...SX070N0-... DS7-34...SX081N0-... DS7-34...SX100N0-...			170M4008
		315	58	S1	DS7-34...SX135N0-...			170M4010
		400	65	S2	DS7-34...SX160N0-... DS7-34...SX200N0-...			170M5008

	For use with	Article no.	Price see price list	Std. pack	Information relevant for export to North America 
Fuse Bases					
	Dimensions (W x H x D) mm 145 x 43 x 50	000, 00	170H1007	3 off 	Product Standards IEC/EN 60269-1; UL 512; CE marking E14853 UL File No. UL Category Control No. IZLT2 North America Certification Suitable for UL listed DIN 43653 fuses
	205 x 88 x 80	S1*, S1, S2, S3	170H3004		

	For use with	Part no. Article no.	Price see price list	Std. pack	Information relevant for export to North America 
Overload relays					
	DS7-34...SX004...	ZB12-4 278438		1 off 	Product Standards UL 508; CSA-C22.2 No. 14; IEC/EN 60947-4-1; IEC/EN 60947-5-1; CE marking UL File No. E29184 UL Category Control No. NKCR CSA File No. 12528 CSA Class No. 3211-03 North America Certification UL listed, CSA certified Suitable for Branch circuits Max. Voltage Rating 600 V AC Degree of Protection IEC: IP20, UL/CSA Type: -
	DS7-34...SX007... DS7-34...SX009...	ZB12-10 278440			
	DS7-34...SX012...	ZB12-12 278441			
	DS7-34...SX016...	ZB32-16 278452			
	DS7-34...SX024...	ZB32-24 278453			
	DS7-34...SX032...	ZB32-32 278454			
Wiring set					
For DOL Starter					
	DS7-34...SX004... DS7-34...SX007... DS7-34...SX009... DS7-34...SX012...	PKZM0-XDM12 283149		1 off 	Product Standards UL 508; CSA-C22.2 No. 14; IEC60947-4-1; CE marking UL File No. E36332 UL Category Control No. NLRV CSA File No. 165628 CSA Class No. 3211-05 North America Certification UL listed, CSA certified
	Electric contact module				
	DS7-34...SX016... DS7-34...SX024... DS7-34...SX032...	PKZM0-XM32DE 239349		5 off 	Product Standards UL 508; CSA-C22.2 No. 14; IEC60947-4-1; CE marking UL File No. E36332 UL Category Control No. NLRV CSA File No. 165628 CSA Class No. 3211-05 North America Certification UL listed, CSA certified
Busbar adapters					
	PKZM0, PKE + DS7...004N... PKZM0, PKE + DS7...007N... PKZM0, PKE + DS7...009N... PKZM0, PKE + DS7...012N...	BBA0L-25 142526		1 off	
	PKZM0, PKE + DS7...016N... PKZM0, PKE + DS7...024N... PKZM0, PKE + DS7...032N...	BBA0L-32 142527		1 off	
Top-hat rail adapter					
45 mm wide adapter plate					
	PKZM0, PKE + DS7...004N... PKZM0, PKE + DS7...007N... PKZM0, PKE + DS7...009N... PKZM0, PKE + DS7...012N...	PKZM0-XC45L 142529		1 off	
	PKZM0, PKE + DS7...016N... PKZM0, PKE + DS7...024N... PKZM0, PKE + DS7...032N...	PKZM0-XC45L/2 142570		1 off	

For use with	Part no. Article no.	Price see price list	Std. pack	Notes	Information relevant for export to North America 
Three-phase commoning links					
protected against accidental contact, short-circuit proof, $U_e = 690\text{ V}$, $I_u = 35\text{ A}$ can be extended by rotating installation ($\sum I_u \leq 35\text{ A}$)					
	DS7-34...SX004... DS7-34...SX007... DS7-34...SX009... DS7-34...SX012...	DILM12-XDSB0/3 240084	5 off 	For the primary side of DS7 Suitable for 3 DS7 soft starters Length 112 mm	Product Standards IEC/EN 60947-4-1; UL 508; CSA-C22.2 No. 14-05; CE marking E36332
		DILM12-XDSB0/4 240085		For the primary side of DS7 Suitable for 4 DS7 soft starters Length 157 mm	UL File No. UL Category Control No. NLRV CSA File No. 012528 CSA Class No. 2411-03
		DILM12-XDSB0/5 240086		For the primary side of DS7 Suitable for 5 DS7 soft starters Length 202 mm	UL listed, CSA certified
Incoming connection block					
	DS7-34...SX004... DS7-34...SX007... DS7-34...SX009... DS7-34...SX012...	DILM12-XEK 240083	5 off 	For three-phase commoning link, protected against accidental contact, $U_e = 690\text{ V}$, $I_u = 35\text{ A}$. Connection cross section: Stranded 2.5...16 mm ² Flexible with ferrule 2.5...16 mm ² AWG14...8	Product Standards IEC/EN 60947-4-1; UL 508; CSA-C22.2 No. 14-05; CE marking E36332 UL File No. UL Category Control No. NLRV CSA File No. 012528 CSA Class No. 2411-03 North America Certification UL listed, CSA certified
Terminal cover					
knockout 	DS7-34...SX041... DS7-34...SX055... DS7-34...SX070... DS7-34...SX081... DS7-34...SX100...	NZM1-XKSFA 100780	1 off 	-	UL/CSA certification not required
knockout 	DS7-34...SX135... DS7-34...SX160... DS7-34...SX200...	NZM2-XKSFA 104640	1 off 	Type contains parts for a terminal located at top or bottom for 3 pole circuit- breakers. Enhancement of the busbar tag shroud (simple protection against contact with a finger). Protection when reaching into the cable connection area with the connection of cables in the box terminal. With 2 conductors max cross section 22 mm ² or AWG4. Cannot be combined with NZM-XSTK control circuit terminal.	UL/CSA certification not required
	DS7-34...SX135... DS7-34...SX160... DS7-34...SX200...	NZM2-XKSA 260038	1 off 	Type contains parts for a terminal located at top or bottom for 3 pole circuit- breakers. Insulation/protection against direct contact where cable lugs or busbars are connected or tunnel terminals are used. Included in the set with tunnel terminals. When using insulated conductor material to IP1X.	Product Standards UL489; CSA-C22.2 No. 5-09; IEC60947, CE marking E31593 UL File No. UL Category Control No. DIHS 22086 CSA File No. 1432-01 North America Certification UL listed, CSA certified Refer to main component information Suitable for

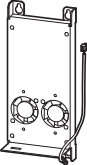
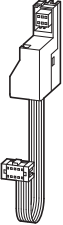
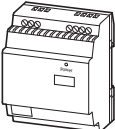
For use with	Part no. Article no.	Price see price list	Std. pack	Notes	Information relevant for export to North America 
IP2X protection against contact with a finger					
Type contains parts for a terminal located at top or bottom for 3 pole circuit-breakers. Enhancement of the busbar tag shroud to IP2X.					
For box terminal 	NZM2, PN2, N2	NZM2-XIPK 266773	1 off 	Protection when reaching into the cable connection area with the connection of cables in the box terminal. With 2 conductors max cross section 25 mm ² or AWG4. Cannot be combined with NZM-XSTK control circuit terminal.	UL/CSA certification not required
for cover NZM2-XKSA or NZM2...(C)NA und N(S)2...NA 	NZM2, PN2, N(S)2	NZM2-XIPA 266777	1 off 	When mounting NZM2...(C)NA or NZM...-NA the following applies: with 2 conductors max cross section 25 mm ² or AWG4.	UL/CSA certification not required
Mounting kit					
when using covers NZM1-XKSFA and NZM2-XKSA					
	DS7-34xSX041N0-x DS7-34xSX055N0-x DS7-34xSX070N0-x DS7-34xSX081N0-x DS7-34xSX100N0-x DS7-34xSX135N0-x DS7-34xSX160N0-x DS7-34xSX200N0-x	DE6-MNT-NZM 107323	1 off	-	
Device fans					
flush-mounted fan					
	DS7-34...SX004... DS7-34...SX007... DS7-34...SX009... DS7-34...SX012... DS7-34...SX016... DS7-34...SX024... DS7-34...SX032...	DS7-FAN-032 135553	1 off 	flush-mounted fan	UL/CSA certification not required
	DS7-34...SX041... DS7-34...SX055... DS7-34...SX070... DS7-34...SX081... DS7-34...SX100...	DS7-FAN-100 169021		Bottom fans	
	DS7-34...SX135... DS7-34...SX160... DS7-34...SX200...	DS7-FAN-200 169022			
PKE communications cable					
6 pole Prefabricated with two plugs For connecting the PKE to DS7-SWD					
	DS7...SWD	PKE32-COM 168970	1 off		
Switched-mode power supply units easyPOW					
Single-phase Nominal input voltage 100 - 240 V AC Rated output voltage 24 V DC (± 3%) Rated output current 1.25 A					
		EASY400-POW 212319	1 off		

Engineering

Generalized phase control of motor voltage

By means of generalized phase control, the soft starter adjusts the grid's voltage (U_{LN}) smoothly from an adjustable start value to 100 % of the rated value U_{LN} .

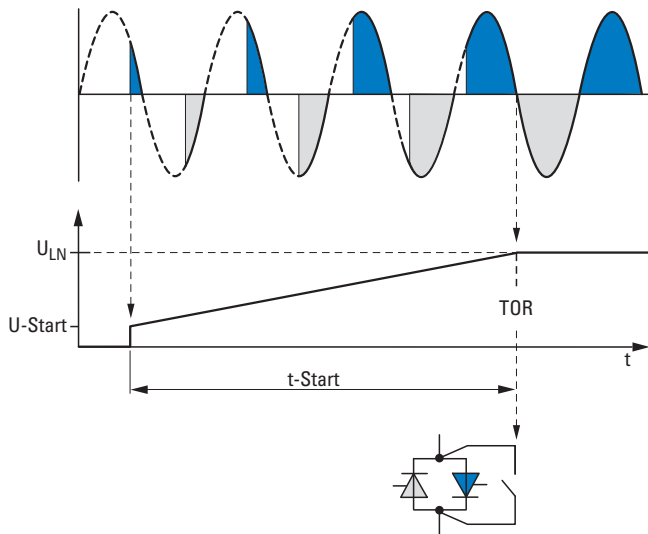

U_{LN} : Mains supply voltage

U-Start: start voltage

t-Start: Ramp time of the voltage change at start

TOR (Top of Ramp): Signals the end of the set "t-Start" ramp time (output voltage U_2 = Mains supply voltage U_{LN}). The internal bypass contacts are closed after this.

This voltage control enables the inrush current of a three-phase asynchronous motor to be limited and its starting torque to be reduced. This enables a smooth and jerk-free increase in torque, adjusted in line with the machine's load behavior. This has a positive effect on the lifespan, operating behavior, and operating processes of the mechanical equipment and prevents negative effects such as:

- Impacting of cog edges in the gearbox
- Pressure surge in pipe systems (water impact),
- Slipping of V belts or
- Jitter with conveyor systems.

In DS7 and S801+/S811+ series soft starters, generalized phase control is achieved with anti-parallel thyristors that are bypassed for continuous operation by using bypass contacts (TOR = Top Of Ramp) after the time for a time-triggered voltage change (t-Start) has elapsed. The transition resistance of these bypass contacts is considerably lower than the transition resistance of the power semiconductors. This reduces the heat dissipation in the soft starter and extends the lifespan of the power semiconductors.

As well as the time-controlled startup of a motor, the soft starter also enables a time-controlled reduction of the motor voltage and thus a controlled stopping of the motor.

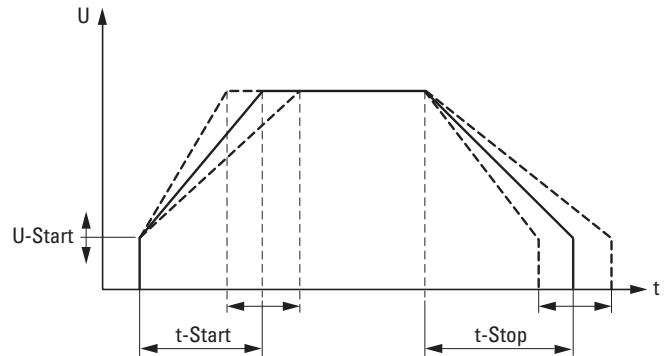

The output voltage of a soft starter determines the torque of the motor ($M \sim U^2$). Because of this, it is necessary to make sure that, when a machine starts up, the selected U-Start start voltage is not too low and the t-Start ramp time for the linear voltage change is set to be as short as possible.

Please note:

- Long ramp times (t-Start) will produce a soft startup behavior, but will also result in a higher thermal load on the thyristors
- A high start voltage (U-Start) will produce a higher torque and a high starting current
- Set the lowest possible start voltage and the shortest possible start ramps.

The following pages include application and setting configuration examples for DS7 soft starters.

If controlled deceleration is required, t-Stop must be set to a longer time than would be necessary for the machine to coast freely based on the load. For the thyristors, the controlled deceleration constitutes a load comparable to that produced during startup. If, for example, the deceleration ramp is activated on a soft starter with a maximum of 10 permissible starts per hour, the number of permissible starts will be reduced to five per hour (plus five stops within that hour).

Selection criteria

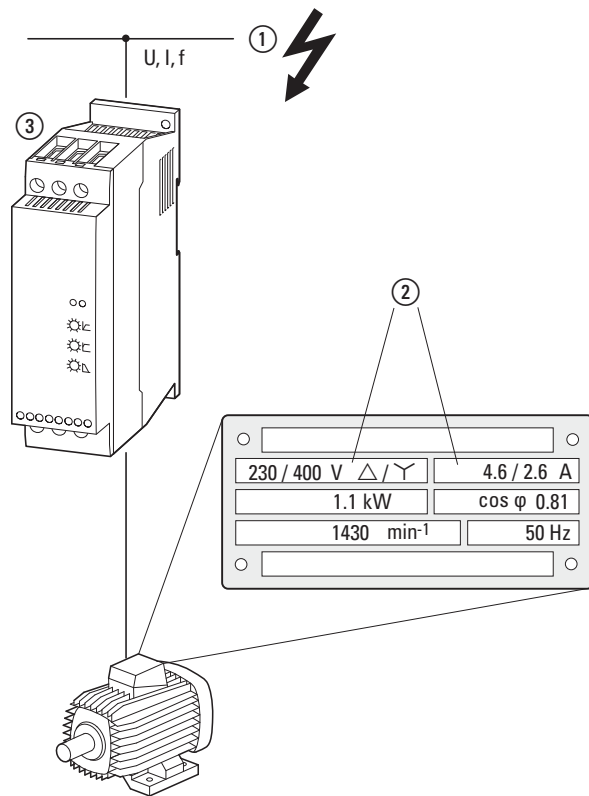

Soft starters ③ are selected based on the supply voltage of the corresponding grid ① (ULN) and the rated operational current of the assigned motor ②. The motor's circuit configuration (Δ/Y) must be selected in such a way that it matches the supply voltage. In addition, the soft starter's rated operational current (I_e) must be at least equal to that of the motor.

Additional selection criteria include:

- Ambient air temperature (rated value +40 °C)
- The number of starts per hour (< 10 starts, take stops into account)
- Load torque (quadratic, linear)
- Starting torque

Centrifugal pumps, centrifugal fans, simple and smooth-running conveyor belts and traction drives, and circular saws and ribbon saws are some of the typical applications for which soft starters are used. Reciprocating compressors, mixers, mills, crushers, and lifting gear are instead categorized as heavy starting duty machines. In this case, the soft starter must be oversized in terms of its overload capacity.

In the case of applications that are typical for a soft starter, such as water pumps (centrifugal pumps), and that feature comparable operational data (operating frequency, run-up time, and/or inrush currents) a soft starter can be assigned directly to the motor on the basis of the rated operational current.

Example:

- 15 kW Pump motor
- 400 V
- Rated operational current 29 A
- About three times the starting current (I_{LRP} = 87 A),
- A maximum of 10 starts per hour
- 5-second start-up time
- ambient air temperature 40 °C.

=> DS7-34...032... (I_e = 32 A)

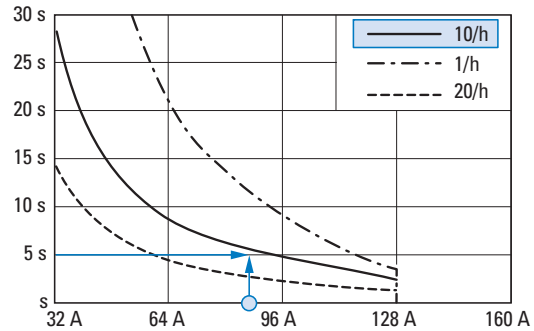

When different operating frequencies, run-up times and/or starting currents are involved, the thermal capacity of the DS7 soft starter must be taken into account in the design. This can be done by using the following diagrams and by calculating the I²t values. These I²t values define the corresponding load capacity and overload cycle and are defined in product standard IEC/EN 60947-4-2.

DS7-34...SX032... soft starter:

- 32A: AC-53a: 3-5: 75-10
- Rated operational current (I_e) 32 A
- Load cycle AC-53a
- 300% overcurrent for 5 seconds
- 75% duty factor with 10 starts per hour

The resulting I²t value is: (3 x 32 A)² x 5 s = 46.080 A²s

The maximum I²t value of the connected motor load must be smaller:

(3 x 29 A)² x 5 s = 37.845 A²s

Soft starter DS7-34...SX032... is the right choice for this application.

If the motor had a higher inrush current, e.g., 5 times the starting current, a more powerful soft starter would have to be selected:

- Motor inrush current: I_{LRP} = 5 x 29 = 145 A, I²t value = (5 x 29 A)² x 5 s = 105.125 A²s
- DS7-34...SX041...: 41A:
AC-53a: 3-5: 75-10
=> (3 x 41 A)² x 5 s = 75.645 A²s

Soft starter DS7-34...SX041... cannot meet the required startup and load conditions required in this case.

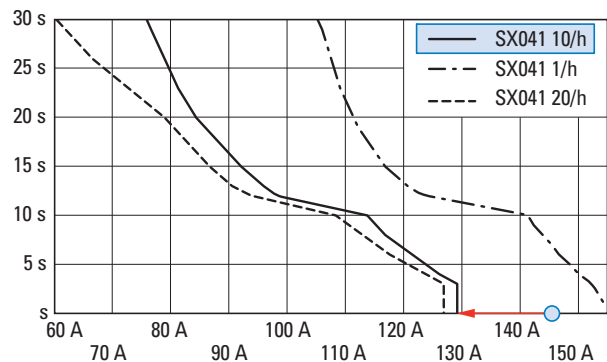

DS7-34...SX055...:

55A: AC-53a: 3-5: 75-10

=> (3 x 55 A)² x 5 s = 136.125 A²s

Soft starter DS7-34...SX055..., however, does meet the required startup and load conditions.

Note: As the following diagram shows, the DS7-34...SX055... unit can handle even more demanding startup and load requirements, e.g., up to 20 starts per hour and longer start-up times (up to 10 seconds).

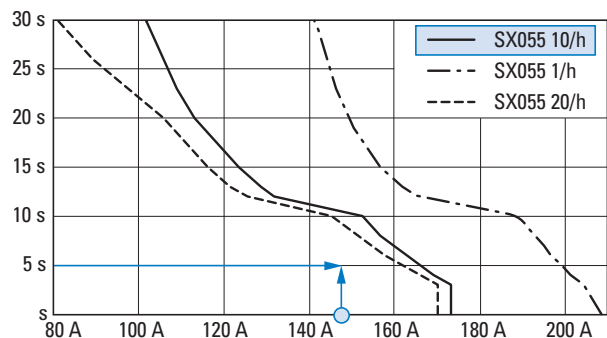

DS7-34...SX004...

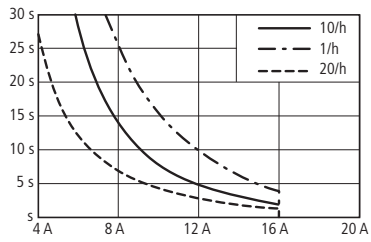

DS7-34...SX007...

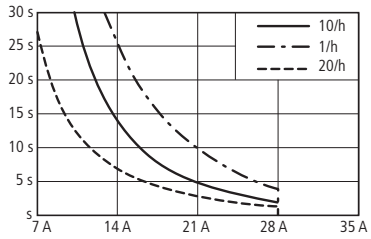

DS7-34...SX009...

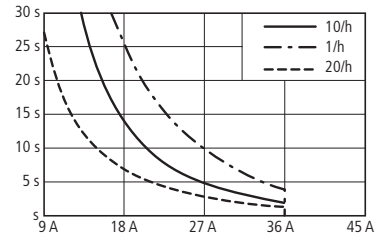

DS7-34...SX012...

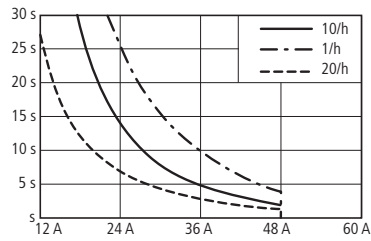

DS7-34...SX016...

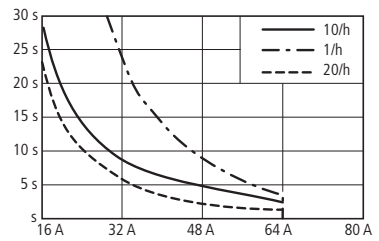

DS7-34...SX024...

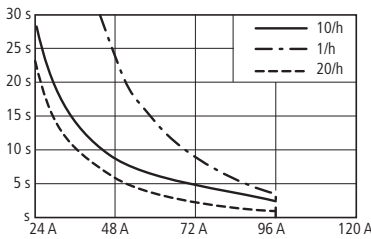

DS7-34...SX032E...

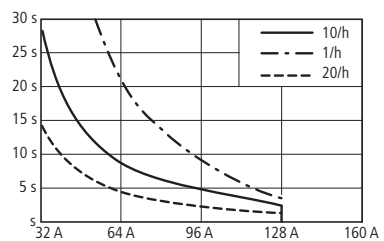

DS7-34...SX041N0-...

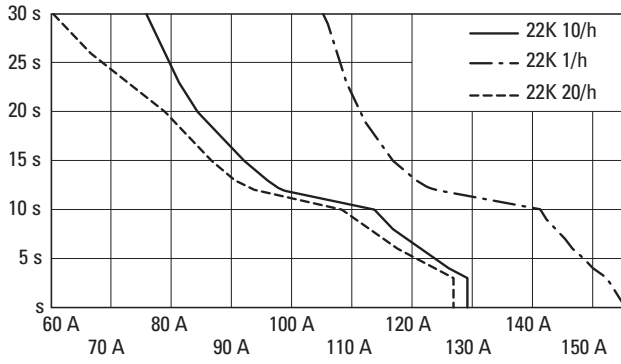

DS7-34...SX055N0-...

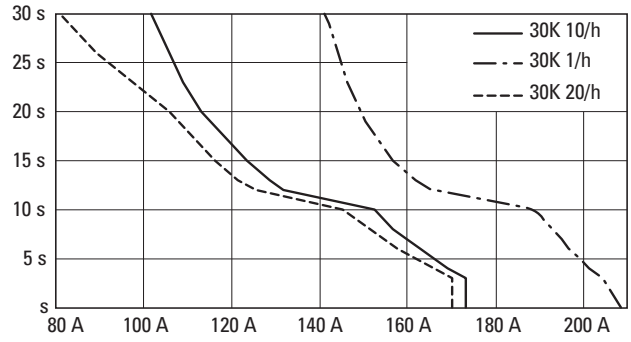

DS7-34...SX070N0-...

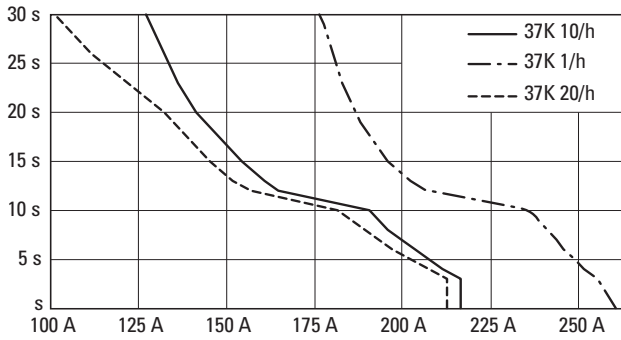

DS7-34...SX081N0-...

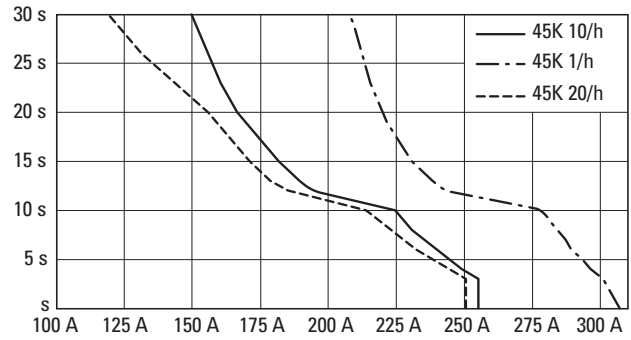

DS7-34...SX100N0-...

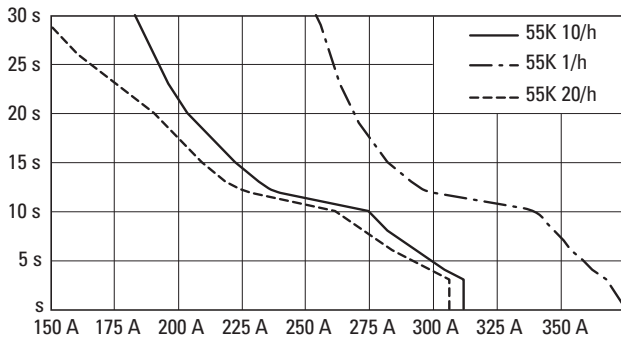

DS7-34...SX135N0-...

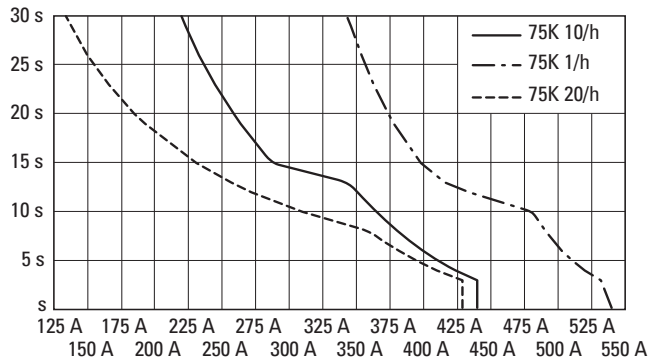

DS7-34...SX160N0-...

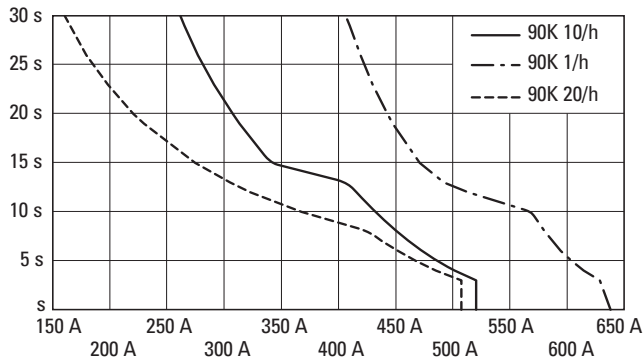

DS7-34...SX200N0-...

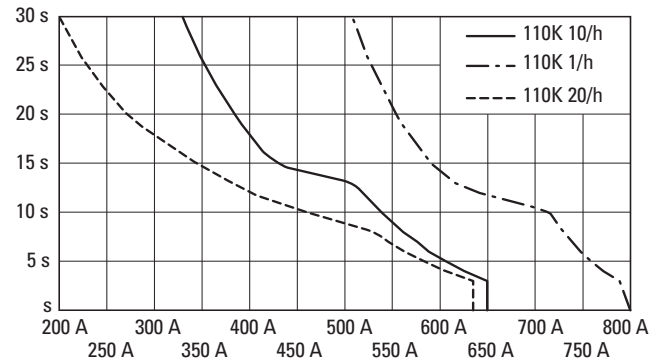

DS7

Standard connection

up to 12 A

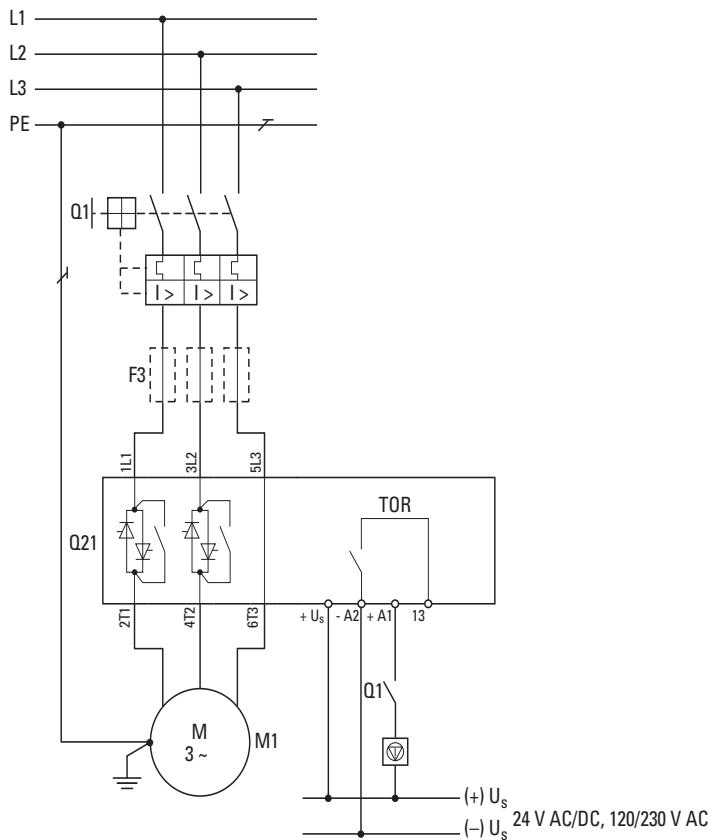

Standard connection

up to 32 A

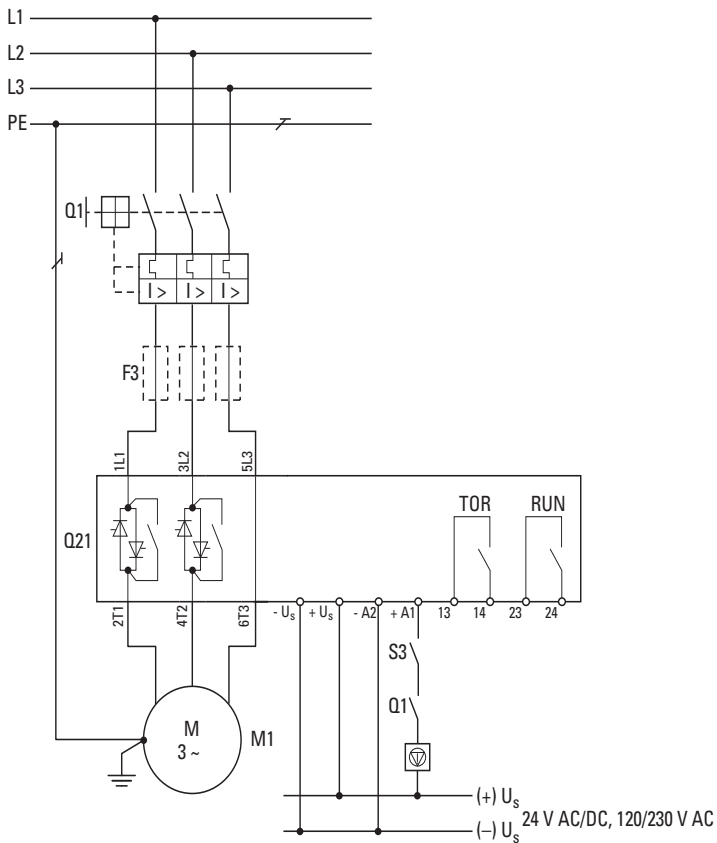

Standard connection

41 - 200 A

With Emergency switching off function according to IEC/EN 60 204-1 and VDE 0113 Part 1

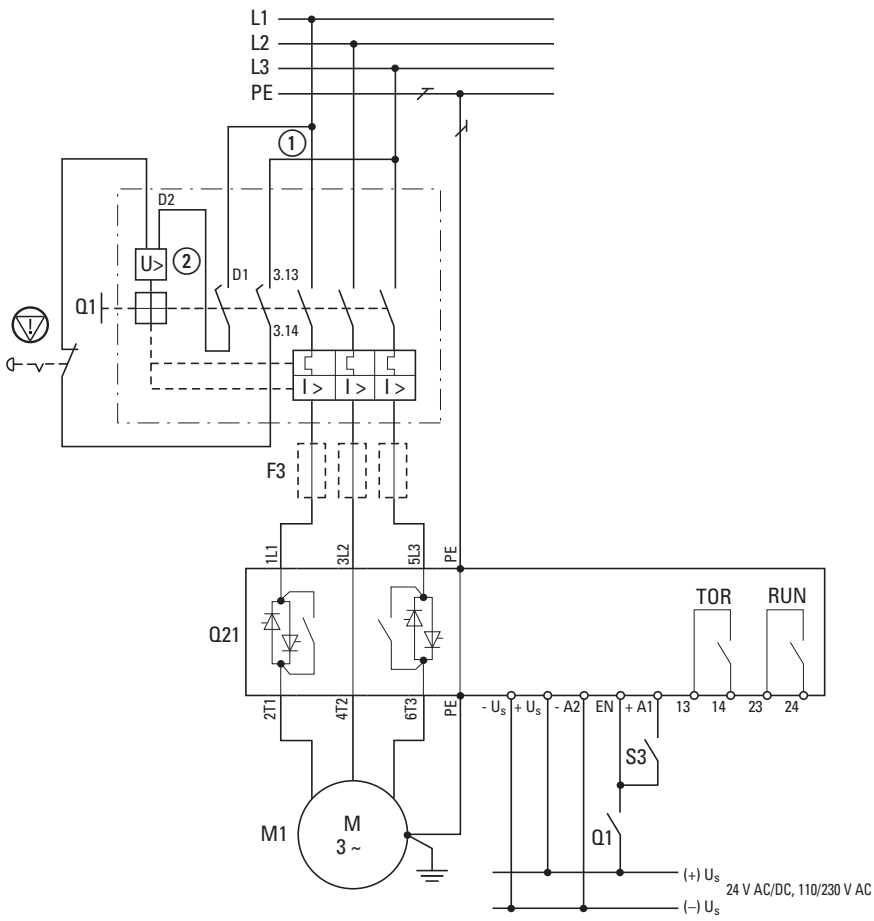

⊕ = EMERGENCY SWITCHING OFF

Q 1 = Cable and motor protection (NZM1, NZM2)

Q21 = Soft starter DS7

M1 = Motor

F3 = superfast semiconductor fuse, optional for type 2 coordination (in addition to Q1)

① Control circuit terminal

② Undervoltage release with early-make auxiliary contact

assigned Motor output at		Rated operational current ¹⁾		Part no. Soft starters (device to be selected)	Soft starter function Cable protection ²⁾ Type "1" coordination
400 V P kW	480 V P HP	Motor I_e A	Soft starters I_e A		
				Soft starters for three-phase mains connection, low operating frequency (5 s, 3 x I_e, 10 starts/h)	
1.5	2	3.6	4	DS7-34xSX004N0-x	PKZM0-4 (+ CL-PKZ0)
3	3	6.6	7	DS7-34xSX007N0-x	PKZM0-10 (+ CL-PKZ0)
4	5	8.5	9	DS7-34xSX009N0-x	PKZM0-10 (+ CL-PKZ0)
5.5	7.5	11.3	12	DS7-34xSX012N0-x	PKZM0-12 (+ CL-PKZ0)
7.5	10	15.2	16	DS7-34xSX016N0-x	PKZM0-16 (+ CL-PKZ0)
11	15	21.7	24	DS7-34xSX024N0-x	PKZM0-25 (+ CL-PKZ0)
15	20	29.3	32	DS7-34xSX032N0-x	PKZM0-32 (+ CL-PKZ0)
22	25	41	41	DS7-34xSX041N0-x	NZMN1-M50 / PKZM4-50
30	30	55	55	DS7-34xSX055N0-x	NZMN1-M63 / PKZM4-58
37	40	68	70	DS7-34xSX070N0-x	NZMN1-M80
45	50	81	81	DS7-34xSX081N0-x	NZMN1-M100
55	60	99	100	DS7-34xSX100N0-x	NZMN1-M100
75	75	134	135	DS7-34xSX135N0-x	NZMN2-M160
90	100	160	160	DS7-34xSX160N0-x	NZMN2-M200
110	125	196	200	DS7-34xSX200N0-x	NZMN2-M200

Notes

¹⁾ Rated operational current based on the load cycle specified here.

²⁾ Used to specify the circuit-breaker required for the specified load cycle. At different duty cycles (operating frequency, overcurrent, overcurrent time, duty factor), this value changes and must then be adapted accordingly.

³⁾ An external overload relay is required if the main contacts should not be disconnected in the event of an overload and a controlled soft stop is desired instead.

⁴⁾ A mains contactor is not required. Disconnection characteristics in accordance with VDE can only be ensured with the specified circuit-breaker.

⁵⁾ The superfast semiconductor fuses protect the soft starter from short circuits on the motor side. This can not, however, prevent damage caused by voltage peaks, for example through lightning strike.

Soft starter function with soft stop in case of overload		Mains contactor	Semiconductor contactor (optional, in addition to the protective devices for type 1 coordination, required for type 2 coordination) ⁵⁾	
Cable protection ²⁾ Type "1" coordination	overload relay ³⁾	optional ⁴⁾	Fuses Number x Part no.	Fuse holders Number x Part no.
PKM0-4 (+ CL-PKZ0)	ZB12-4	DILM7	3 × 170M1359	3 × 170H1007
PKM0-10 (+ CL-PKZ0)	ZB12-10	DILM9	3 × 170M1361	3 × 170H1007
PKM0-10 (+ CL-PKZ0)	ZB12-10	DILM9	3 × 170M1362	3 × 170H1007
PKM0-12 (+ CL-PKZ0)	ZB12-12	DILM12	3 × 170M1362	3 × 170H1007
PZM0-16 (+ CL-PKZ0)	ZB32-16	DILM17	3 × 170M1364	3 × 170H1007
PZM0-25 (+ CL-PKZ0)	ZB32-24	DILM25	3 × 170M1365	3 × 170H1007
PZM0-32 (+ CL-PKZ0)	ZB32-32	DILM32	3 × 170M1366	3 × 170H1007
NZMN1-M50 / PKZM4-50	ZB65-40+ZB65-XEZ	DILM50	3 × 170M3013	3 × 170H3004
NZMN1-M63 / PKZM4-58	ZB65-57+ZB65-XEZ	DILM65	3 × 170M3013	3 × 170H3004
NZMN1-M80	ZB150-70/KK	DILM80	3 × 170M4008	3 × 170H3004
NZMN1-M100	ZB150-100/KK	DILM95	3 × 170M4008	3 × 170H3004
NZMN1-M100	ZB150-100/KK	DILM115	3 × 170M4008	3 × 170H3004
NZMN2-M160	ZB150-150/KK	DILM150	3 × 170M4010	3 × 170H3004
NZMN2-M200	Z5-160/FF250	DILM185	3 × 170M5008	3 × 170H3004
NZMN2-M200	Z5-220/FF250	DILM225	3 × 170M5008	3 × 170H3004



S801+/S811+ Soft Starters – a Powerful Presence in a Small Design

The unparalleled performance and features behind S801+ and S811+ soft starters build upon the proven capabilities of our soft starter series. With only five frame sizes and rated operational currents of 37 A to 850 A for supply voltages of 200 V to 690 V, S801+ and S811+ units are some of the world's smallest compact soft starters.

These three-phase-controlled soft starters, which feature an internal bypass and comprehensive monitoring and protection mechanisms, provide a soft start and ensure that three-phase motors can remain in continuous operation safely and reliably even in applications with large load torques.

S801+ soft starters are designed with standard applications in mind and make a strong case with their ease of use, while S811+ devices feature a digital control and display unit that provides access to advanced functions for sophisticated applications. In addition, S811+ units can be used not only in a standard line (outside the delta) configuration, but also with an inside-the-delta configuration.



System overview

Soft starter S801+, S811+	118
---------------------------	-----

Description

Soft starter S801+, S811+	119
---------------------------	-----

Key to type references, UL/CSA

Soft starter S801+, S811+	120
---------------------------	-----

Ordering

Soft starter S801+, S811+	121
Accessories	123

Engineering

Connection examples S811+...N3S	125
---------------------------------	-----

System overview



S801+ / S811+ 1
 → page 121

Superfast semiconductor fuses 2
 → page 104

Terminal blocks 3
 → page 124

EtherNet/IP - Modbus/TCP adapter 4
 → page 123

External keypad 5
 → page 123

Description



The soft starters in series S801+ assure reliable operation even under tough and challenging ambient conditions. This series makes a compelling case as a result of its ease of use and is the perfect choice for standard applications such as pumps, fans, compressors, and conveyor belts.

S801+ soft starters have three-phase control and are equipped with internal bypass contacts for continuous operation. With their comprehensive protection and monitoring functions, S801+ soft starters ensure a soft startup, as well as safe and reliable continuous operation, for three-phase motors with rated operational currents of 11 A to 850 A when working with mains voltages of 200 V to 600 V. For example, when used in pump applications, they prevent water impact by using controlled deceleration (soft stop control) and torque monitoring, significantly reducing the mechanical loads exerted on pump systems in the process.

Essential features S801+ / S811+

- Rated operational current: 37 - 850 A
- Parameterizable overload settings: 31–100%
- Adjustable overload classes: class 5, 10, 20, 30
- Base setting: 15 s start ramp, 4 starts per hour, 300% starting current at 40 °C ambient temperature
- Allocated motor outputs for in-line connection:
 - 7.5 - 250 kW (3~ 230 V)
 - 18.5 - 450 kW (3~ 400 V)
- Ambient air temperature: -30 °C to +50 °C
- any required mounting position
- Degree of protection with compact design (IP20 optional)
- 5 compact designs
- Adjustable torque control
- Adjustable kick start
- Efficient use of power achieved with internal bypass contacts during continuous operation
- 24-V control voltage:
 - External supply required
 - 1 A continuous current
 - 10 A Inrush current (peak value for 150 ms)

S801+ specific characteristics

- Microswitches and potentiometers make it easy to configure these soft starters

S811+ series soft starters provide all the features and characteristics of S801+ soft starters, plus expanded functionality and an operating unit (DIM = digital interface module).

With the S811+, motors can be connected using the standard line configuration or using the delta circuit (inside-the-delta configuration / six-wire connection). Using an inside-the-delta configuration will reduce the current flowing through the soft starter by approximately 42%. This way, a 58 A soft starter can be used to start and run a motor with a rated operational current of 100 A, for example.



Important operating unit characteristics (S811+)

- Language-neutral LCD display with backlight
- Easy to use and configure with function keys
- System parameter configuration
- Diagnostic and monitoring options
- Reading display (e.g., L1, L2, L3 phase currents)
- Error Display
- Offset placement (mounted on door), connection via plug-in patch cord with RJ11 plug
- Front IP54

S811+ specific characteristics

- Mains voltage up to 690 V
- Allocated motor outputs for in-line connection:
 - 7.5 - 250 kW (3~ 230 V)
 - 18.5 - 450 kW (3~ 400 V)
 - 160 - 710 kW (3~ 690 V)
- Special pump control algorithm with prolonged soft stop ramp
- In-delta connection, see "Engineering, connecting examples"
- RS485 Modbus Connection
- EtherNet-IP/Modbus-TCP with option C441 (communication adapter).

Key to type references

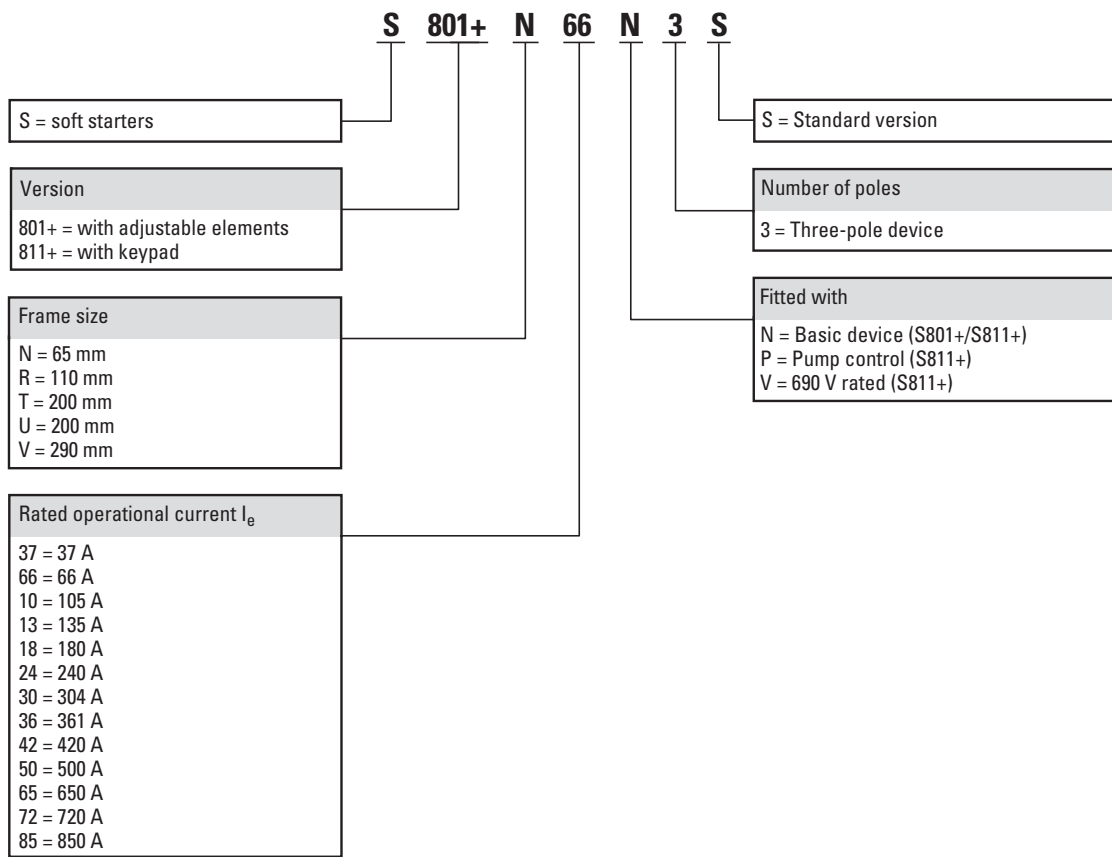

UL/CSA

Information relevant for export to North America





	S801+N..., S801+R..., S801+T... (600 V) S811+N..., S811+R..., S811+T... (600 V)
Product Standards	IEC/EN 60947-4-2; UL 508; CSA C22.2 No. 14; CE marking
UL File No.	E202571
UL CCN	NMFT
CSA File No.	LR 353
CSA Class No.	3211-06, 2411-01
NA Certification	UL Listed, CSA Certified
Conditions of Acceptability	None
Suitable for	Branch Circuits, not as BCPD
Max. Voltage Rating	600 Vac
Degree of Protection	IP20 with kit

	S801+U..., S801+V... bis 850 A (600 V) S811+U..., S811+V... bis 850 A (600 V)
Product Standards	IEC/EN 60947-4-2; UL 508; CSA C22.2 No. 14; CE marking
UL File No.	E202571
UL CCN	NMFT
CSA File No.	LR 353
CSA Class No.	3211-06
NA Certification	UL Listed, CSA Certified
Conditions of Acceptability	None
Suitable for	Branch Circuits, not as BCPD
Max. Voltage Rating	600 Vac
Degree of Protection	IP20 with kit

	S811+...V3S (690 V)
Product Standards	IEC/EN 60947-4-2; UL 508; CE marking
UL File No.	E202571
UL CCN	NMFT
CSA File No.	
CSA Class No.	
NA Certification	UL Listed
Conditions of Acceptability	None
Suitable for	Branch Circuits, not as BCPD
Max. Voltage Rating	690 Vac
Degree of Protection	IP20 with kit

	S811+...V3S (690 V)
Product Standards	IEC/EN 60947-4-2; UL 508; CE marking
UL File No.	E202571
UL CCN	NMFT
CSA File No.	
CSA Class No.	
NA Certification	UL Listed
Conditions of Acceptability	None
Suitable for	Branch Circuits, not as BCPD
Max. Voltage Rating	690 Vac
Degree of Protection	IP20 with kit

Ordering

Frame size	Rated operational current AC-53 I_e A	Assigned motor rating				Part no.	Article no.	Price see price list	Std. pack
		at 230 V, 50 Hz kW	at 230 V, 60 Hz HP	at 400 V, 50 Hz kW	at 460 V, 60 Hz HP				
Soft starters									
Supply voltage U_s : 24 V DC Control voltage U_c : 24 V DC With internal bypass contacts Terminal blocks for the terminals are required for frame sizes T, U, and V -> Accessories									
Soft starters for three-phase loads Mains supply voltage (50/60 Hz) U_{LN} : 200 - 600 V AC In-line circuit									
N	37	7.5	10	18.5	25	S801+N37N3S	169852		1 off  
	66	18.5	20	30	50	S801+N66N3S	169853		
R	105	30	40	55	75	S801+R10N3S	169854		
	135	37	50	75	100	S801+R13N3S	169855		
T	180	55	60	90	150	S801+T18N3S	169856		
	240	75	75	132	200	S801+T24N3S	169857		
	304	90	100	160	250	S801+T30N3S	169858		
U	361	110	125	200	300	S801+U36N3S	169859		
	420	132	150	200	350	S801+U42N3S	169860		
V	361	110	125	200	300	S801+V36N3S	169863		
	420	132	150	200	350	S801+V42N3S	169864		
	500	160	200	250	400	S801+V50N3S	169865		
	650	200	250	315	500	S801+V65N3S	169866		
	720	250	-	400	600	S801+V72N3S	169867		
	850	-	-	450	600	S801+V85N3S	169868		
Soft starter for three-phase loads, with control unit Mains supply voltage (50/60 Hz) U_{LN} : 200 - 600 V AC In-line configuration/In-delta configuration									
N	37	7.5	10	18.5	25	S811+N37N3S	168976		1 off  
	66	18.5	20	30	50	S811+N66N3S	168978		
R	105	30	40	55	75	S811+R10N3S	168980		
	135	37	50	75	100	S811+R13N3S	168982		
T	180	55	60	90	150	S811+T18N3S	168984		
	240	75	75	132	200	S811+T24N3S	168987		
	304	90	100	160	250	S811+T30N3S	168990		
U	361	110	125	200	300	S811+U36N3S	169869		
	420	132	150	200	350	S811+U42N3S	169870		
V	361	110	125	200	300	S811+V36N3S	168993		
	420	132	150	200	350	S811+V42N3S	168996		
	500	160	200	250	400	S811+V50N3S	168999		
	650	200	250	315	500	S811+V65N3S	169002		
	720	250	-	400	600	S811+V72N3S	169005		
	850	-	-	450	600	S811+V85N3S	169008		

Notes   Information relevant for export to North America → Page 120





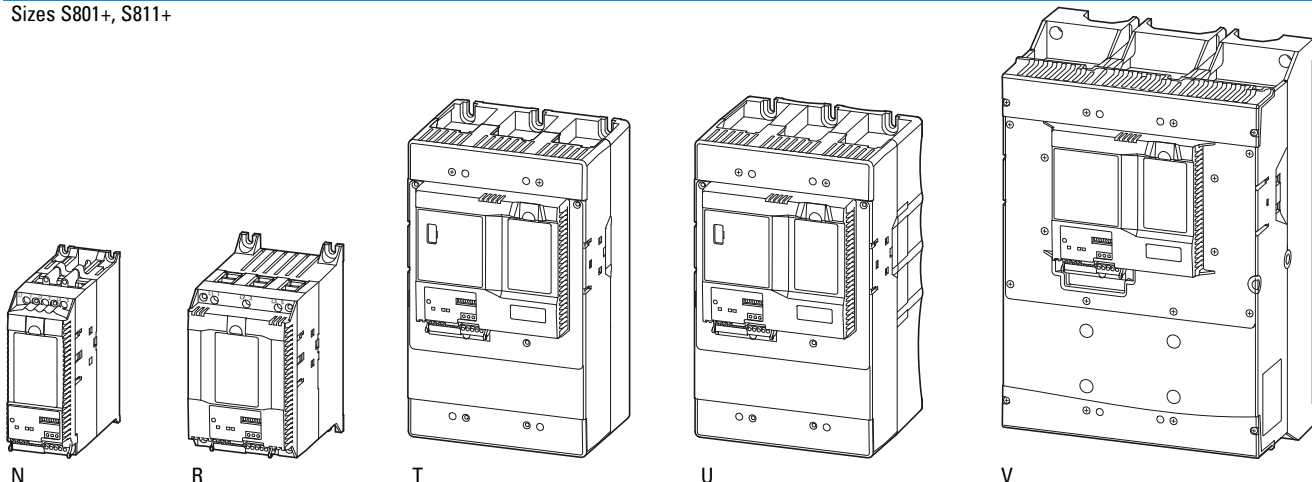

S801+/S811+

Frame size	Rated operational current AC-53 I_e A	Assigned motor rating					Part no.	Article no.	Price see price list	Std. pack
		at 230 V, 50 Hz kW	at 230 V, 60 Hz HP	at 400 V, 50 Hz kW	at 460 V, 60 Hz HP	at 690 V, 50 Hz kW				
Soft starters										
Supply voltage U_s : 24 V DC Control voltage U_c : 24 V DC With internal bypass contacts Terminal blocks for the terminals are required for frame sizes T, U, and V -> Accessories										
Soft starter for three-phase loads, with control unit and pump algorithm Mains supply voltage (50/60 Hz) U_{LN} : 200 - 600 V AC In-line configuration/In-delta configuration										
N	37	7.5	10	18.5	25	-	S811+N37P3S	168977		1 off
	66	18.5	20	30	50	-	S811+N66P3S	168979		
R	105	30	40	55	75	-	S811+R10P3S	168981		
	135	37	50	75	100	-	S811+R13P3S	168983		
T	180	55	60	90	150	-	S811+T18P3S	168985		
	240	75	75	132	200	-	S811+T24P3S	168988		
	304	90	100	160	250	-	S811+T30P3S	168991		
U	361	110	125	200	300	-	S811+U36P3S	169872		
	420	132	150	200	350	-	S811+U42P3S	169873		
V	361	110	125	200	300	-	S811+V36P3S	168994		
	420	132	150	200	350	-	S811+V42P3S	168997		
	500	160	200	250	400	-	S811+V50P3S	169000		
	650	200	250	315	500	-	S811+V65P3S	169003		
	720	250	-	400	600	-	S811+V72P3S	169006		
	850	-	-	450	600	-	S811+V85P3S	169009		
Soft starter for three-phase loads, with control unit and pump algorithm, for 690-V grids Mains supply voltage (50/60 Hz) U_{LN} : 200 - 690 V AC In-line circuit										
T	180	55	60	90	150	160	S811+T18V3S	168986		1 off
	240	75	75	132	200	200	S811+T24V3S	168989		
	304	90	100	160	250	250	S811+T30V3S	168992		
V	361	110	150	200	300	315	S811+V36V3S	168995		
	420	132	150	200	350	400	S811+V42V3S	168998		
	500	160	200	250	400	500	S811+V50V3S	169001		
	650	200	250	315	500	630	S811+V65V3S	169004		
	720	250	-	400	600	630	S811+V72V3S	169007		
	850	-	-	450	600	710	S811+V85V3S	169010		

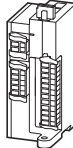

Sizes S801+, S811+



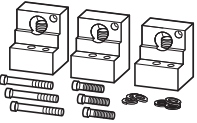

Information relevant for export to North America → Page 120

Description	For use with	Part no. Article no.	Price see price list	Std. pack	Information relevant for export to North America 
Control unit					
With adjusting elements (potentiometer, microswitch)	S801+	EMA71 144346		1 off 	Product Standards IEC/EN 60947-4-2; UL 508; CSA C22.2 No. 14; CE marking E202571 UL File No. CSA File No. LR 353 Conditions of Acceptability UL unlisted component, CSA Investigated Component
With illuminated LCD display With control buttons and function keys Front IP54 RJ11 plug, 6-pin	S811+	EMA91 144570			
Cover					
Protection for installation space in S811+ if the control unit is set up externally.	S801+	EMA68 144556		1 off	
Mounting frame					
For mounting the EMA91 control unit externally with surface mounting (e.g., installation in control panel door).					
with connection cable RJ11, 6 pole	1 m	EMA91	EMA69A 144557	1 off 	Product Standards IEC/EN 60947-4-2; UL 508; CSA C22.2 No. 14; CE marking E202571 UL File No. UL Category Control No. CSA File No. LR 353 CSA Class No. 3211-06 North America Certification UL listed, CSA certified
	1.5 m	EMA91	EMA69B 144558		
	2 m	EMA91	EMA69C 144559		
	3 m	EMA91	EMA69D 144560		
Fieldbus modules					
 Ethernet-IP/Modbus-TCP	S811+	C441V 172306		1 off 	Product Standards IEC/EN 60947-4-1; UL 508; CSA C22.2 No. 14; CE marking E1230 UL File No. UL Category Control No. NKCR CSA File No. LR 353 CSA Class No. 3211-03 North America Certification UL listed, CSA certified Max. Voltage Rating 240 Vac (auxiliary contacts)
PROFIBUS-DP	S811+	C441QS 184746		1 off 	Product Standards CSA C22.2 No. 14; CE marking E1230 UL File No. UL Category Control No. NKCR CSA File No. LR 353 CSA Class No. 3211-03 North America Certification UL listed, CSA certified Max. Voltage Rating 240 Vac (auxiliary contacts)
DeviceNet	S811+	C441LS 184747		1 off 	
Control terminal strip					
Spare part	S801+, S811+	EMA75 144561		1 off	

S801+/S811+

Description	For use with	Part no. Article no.	Price see price list	Std. pack	Information relevant for export to North America 
Terminal blocks					
Tools with dimensions in inches required 1 set required for each connection side.					
					
Terminal capacities					
2 x 4-1/0MCM, 2 x 25-50 mm ²	S801+, S811+, frame sizes T and U	EML22 127661		1 off 	Product Standards UL508, CSA C22.2 No. 65 UL File No. E202571 UL Category Control No. NMFT CSA File No. LR 353 CSA Class No. 6223-02 North America Certification UL listed, CSA certified
4/0-500 MCM, 120-240 mm ² S801+, S811+, frame sizes T and U		EML23 127662			
2 x 4/0-500 MCM, 2 x 120-240 mm ² S801+, S811+, frame sizes T and U		EML24 127663			
1 x 2/0-300 MCM, 1 x 70-150 mm ² S801+, S811+, frame sizes T and U		EML25 127664			
2 x 2/0-300 MCM, 2 x 70-150 mm ² S801+, S811+, frame sizes T and U		EML26 127665			
2 x 4/0-500 MCM, 2 x 120-240 mm ² S801+, S811+, frame size V	S801+, S811+, frame size V	EML28 127666			
4 x 4/0-500 MCM, 4 x 120-240 mm ² S801+, S811+, frame size V		EML30 127667			
6 x 4/0-500 MCM, 6 x 120-240 mm ² S801+, S811+, frame size V		EML32 127668			
4 x 2/0-300 MCM, 4 x 70-150 mm ² S801+, S811+, frame size V		EML33 127669			

Description	For use with	Part no. Article no.	Price see price list	Std. pack	Information relevant for export to North America 
terminal shroud					
For increasing the degree of protection to IP20 1 set required for each connection side.	S801+, S811+, frame size N	SS-IP20-N 171990		1 off	
	S801+, S811+, frame size R	SS-IP20-R 171991			
	S801+, S811+, frame sizes T und U	SS-IP20-TU 171992			
	S801+, S811+, frame size V	SS-IP20-V 158650			
TVSS					
SMD metal-oxide varistors (MOVs) with connection cables for the grid and motor connection sides	S801+, S811+, up to 600 V	EMS39 127671		1 off 	Product Standards UL 508; CSA C22.2 No. 14 UL File No. E202571 CSA File No. LR 353 Conditions of Acceptability UL and CSA Investigated Component Max. Voltage Rating 1000 V _{ac} 3 ph
	S811+, up to 690 V	EMS41 127672			

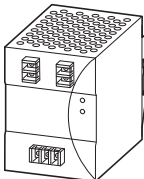
Power supplies PSG					
Rated output voltage 24 V DC (± 2%) Rated output current 10 A					
	Nominal input voltage 100 - 240 V AC 125 - 250 V DC Single-phase	PSG240E24RM 172893			
	Nominal input voltage 3 x 400 - 500 V AC Three-phase	PSG240F24RM 172884			

Engineering

Connection examples for S811+...N3S

Standard connection (in-line connection)

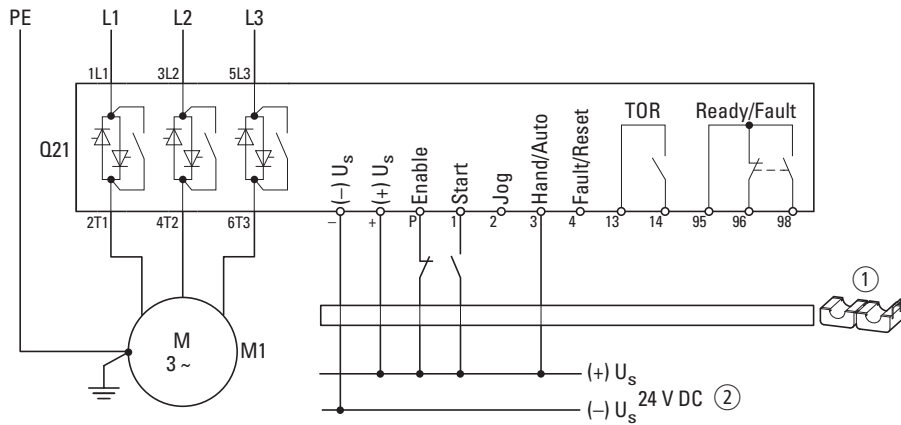

Delta circuit (inside-the-delta circuit)

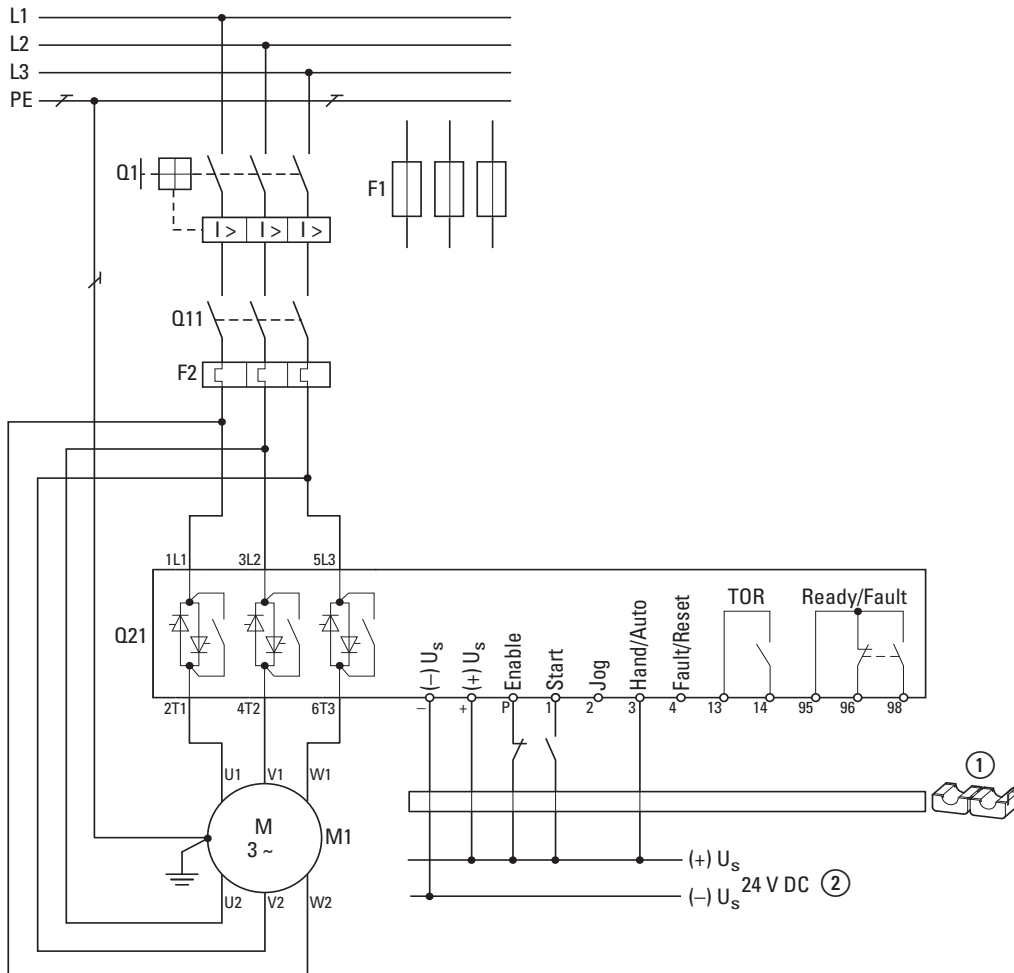

① Snap-on ferrite core, included as standard

② External control voltage (24 VDC) required, I_S 1 A, I_{Peak} = 10 A for 150 ms when bypass contacts are switched
Short-circuit and cable protection: Q1 circuit-breakers or F1 fuses.

Motor

IEC

U1-V1-W1

U2-V2-W2

NEMA

T1-T2-T3

T4-T5-T6



Distributed Drive System Rapid Link 4.0

Standardized installation procedures, the ability to directly and locally configure parameters with a plug and play configuration, and networked communications – these are the needs of material handling system applications today when it comes to state-of-the-art drive engineering and the systems it produces.

Eaton delivers a modern answer with the Rapid Link 4.0 distributed drive system. With its flexible power spectrum, its simple handling and its intelligent programming options, this new motor starter and variable frequency drives generation is the first choice for all kinds of conveying engineering applications.

RAMO electronic motor starters

Electronic DOL and reversing starters with a lifespan of more than 10 million operations, degree of protection IP65

Rated operational current, adjustable between 0.3 – 6.6 A when using a three-phase mains connection with 400 V – 480 V, for rated motor outputs of up to 3.0 kW (400 V) / 3 HP (460 V)

RAMO-D...: DOL starter

RAMO-W...: reversing starter

RASP speed controllers



Frequency-controlled motor starters with Volts-per-Hertz control (V/Hz control) and slip compensation or vector control, as well as an integrated radio interference suppression filter (EMC); IP65 degree of protection.

RASP-2...: Rated operational current of 0.48 – 2.4 A with three-phase mains connection of 400 V – 480 V, allocated motor output of up to 0.75 kW (400 V) / 1 HP (460 V)

RASP-3...: Rated operational current of 0.66 – 3.3 A with three-phase mains connection of 400 V – 480 V, allocated motor output of up to 1.1 kW (400 V) / 1.5 HP (460 V)

RASP-4...: Rated operational current of 0.86 – 4.3 A with three-phase mains connection of 400 V – 480 V, allocated motor output of up to 1.5 kW (400 V) / 2 HP (460 V)

RASP-5...: Rated operational current of 1.12 – 5.6 A with three-phase mains connection of 400 V – 480 V, allocated motor output of up to 2.2 kW (400 V) / 3 HP (460 V)

	System overview	128
	Description	
	Application and function, features	130
	Key to type references	131
	Ordering	
	Motor starter RAMO	132
	RASP speed controllers	133
	Accessories	134
	Engineering	
	General information on Engineering	138
	Block diagram DOL starter RAMO-D	140
	Block diagram RAMO-W reversing starter	141
	Block diagram RASP with 230V brake	142
	Block diagram RASP with 400V brake	143

System overview

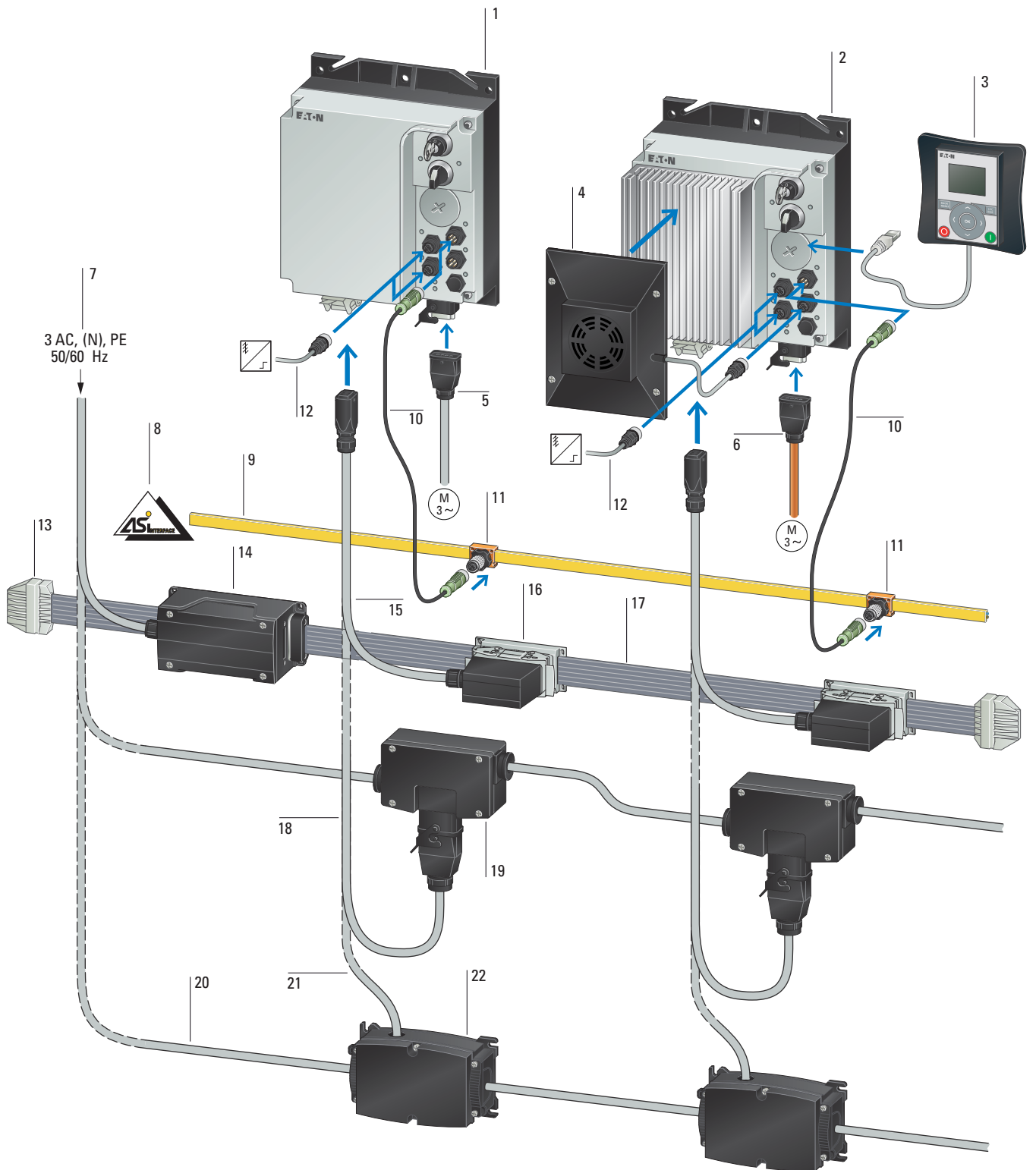

Function modules

Motor starter (Motor Control Unit)	1
Three-phase electronic DOL starter or reversing starter	
→ page 132	
Speed controller RASP (Speed Control Unit)	2
Three phase frequency-controlled motor starter (fixed speeds, two rotational directions, adjustable acceleration and deceleration ramps)	
→ page 133	
Operating unit	3
for parameter setting	
→ page 134	
Fans	4
for operation at high temperatures without derating	
→ page 134	

Motor feeder

Unscreened motor cable	5
→ page 134	
Screened motor supply cable (EMC)	6
→ page 134	

Power and data bus

Energy supply (3 AC 400 V) via circuit-breaker for overload and short-circuit protection	7
for protection against short-circuit and overload	
AS-Interface® supply	8
AS-Interface® flat cable	9
AS-Interface® connection cable	10
→ page 137	
AS-Interface® junction	11
→ page 137	
Sensor connection	12
→ page 137	
End-piece for flat cable	13
→ page 136	
Distribution module	14
for 400-V-AC incoming unit of the flat cable	
→ page 135	
Power connection cable	15
to flexible busbar junction	
→ page 134	
flexible busbar junction	16
→ page 135	
Ribbon cable for 400 V AC	17
→ page 134	
Power connection cable	18
to round cable junction	
→ page 136	
Round cable junction	19
→ page 136	
Round cable for 400 V AC	20
Power connection cable	21
to round cable junction	
→ page 136	
Round cable junction	22
→ page 136	

Rapid Link 4.0 is a modern, efficient drive and PLC. It is the competent further development of the Rapid Link 2.1/3.0 device series, suitable for simple and complex tasks in all aspects of material handling. For example in airports, industrial production and logistics centers. The Rapid Link system consists of the RAMO electronic motor starters and the RASP frequency controlled motor starters.

The RAMO and RASP motor starters are designed with IP65 protection and can be installed in direct proximity to the drive. Their versions and mounting depend on the required specifications and the local conditions. The RAMO and RASP are connected with standard plug connectors to the energy and databus systems predominantly used in material handling systems (AS-Interface). Connection can be implemented without interrupting the required location. This simplifies installation and reduces the wiring requirement.



Overview of features

RAMO 4.0 electronic motor starters

Application and function

The RAMO motor starters enable the electronic DOL or reversing starting of three-phase motors in automatic or manual mode. The electronic overload protection for motor ratings from 90 W to 3 kW at 400 V (50/60 Hz) is configured with DIP switches. Full motor protection is ensured when used in connection with temperature sensors.

The operating mode is set via the AUTO - OFF/RESET – MANUAL key switch and can be combined with the 'Quick stop' and 'Interlocked manual operation' via the two sensor inputs (M12 sockets). Operating states are diagnosed and error messages (Reset) acknowledged on the device or via the AS-Interface. RAMO is available in different versions:

- with actuator output (24 V DC) for a direct actuation of external switching devices, e.g. solenoid valves.
- with electronic actuation for mechanical motor brakes.
- with lockable repair switch for diagnostic and maintenance work, making it possible to safely de-energize the device locally.

Essential features

- Standard size in square enclosure. The bottom section with the two power terminals (power plug, motor feeder socket) and the repair and maintenance switch can be turned 90° clockwise and counterclockwise.
- Long lifespan up to 10 million switching operations and up to 3,000 switch cycles per hour at 2.2 kV.
- Rated operational current 6.6 A.
- Operating and ambient temperature from -10 to +55 °C, without derating.
- Monitoring of thermistor and motor cable.
- Maximum motor cable length: 10 m.

Frequency controlled motor starter RASP 4.0

Application and function

The RASP motor starter enables the infinitely variable speed control of three-phase motors in the range from zero to 320 Hz. The standard size for 400 V (50/60 Hz) is assigned four motor ratings: 0.75 kW, 1.1 kW, 1.5 kW and 2.2 kW. Full motor protection is ensured by the adjustable current limitation (I²t controller).

The operating mode is set via the AUTO - OFF/RESET – MANUAL key switch and can be combined with the 'Quick stop' and 'Interlocked manual operation' via the two sensor inputs (M12 sockets). Settable fixed frequencies and cyclical program sequences extend the application range and relieve the load on the higher-level head-end controller (PLC). Operating states are diagnosed and error messages (Reset) acknowledged on the device or via the AS-Interface. A hand-held programmer and a PC interface are available for the parameterization of the variable frequency drive module.

RASP is available in different versions:

- with integrated brake chopper with braking resistance for dynamic braking.
- with electronic actuation for mechanical motor brakes.
- with lockable repair switch for diagnostic and maintenance work, making it possible to safely de-energize the device locally.

Essential features

- Standard size in square enclosure. The bottom section with the two power terminals (power plug, motor feeder socket) and the repair and maintenance switch can be turned 90° clockwise and counterclockwise.
- Monitoring of thermistor and motor cable.
- Operating and ambient temperatures from 0 to +40 °C without derating, with optional fan in the performance range up to 1.5 kW max. +55 °C.
- Rated operational current: 2.4 A, 3.3 A, 4.3 A, 5.6 A
- EMC class C3 in 2nd environment
- Maximum motor cable length: 10 m shielded.

Electronic motor starters RAMO

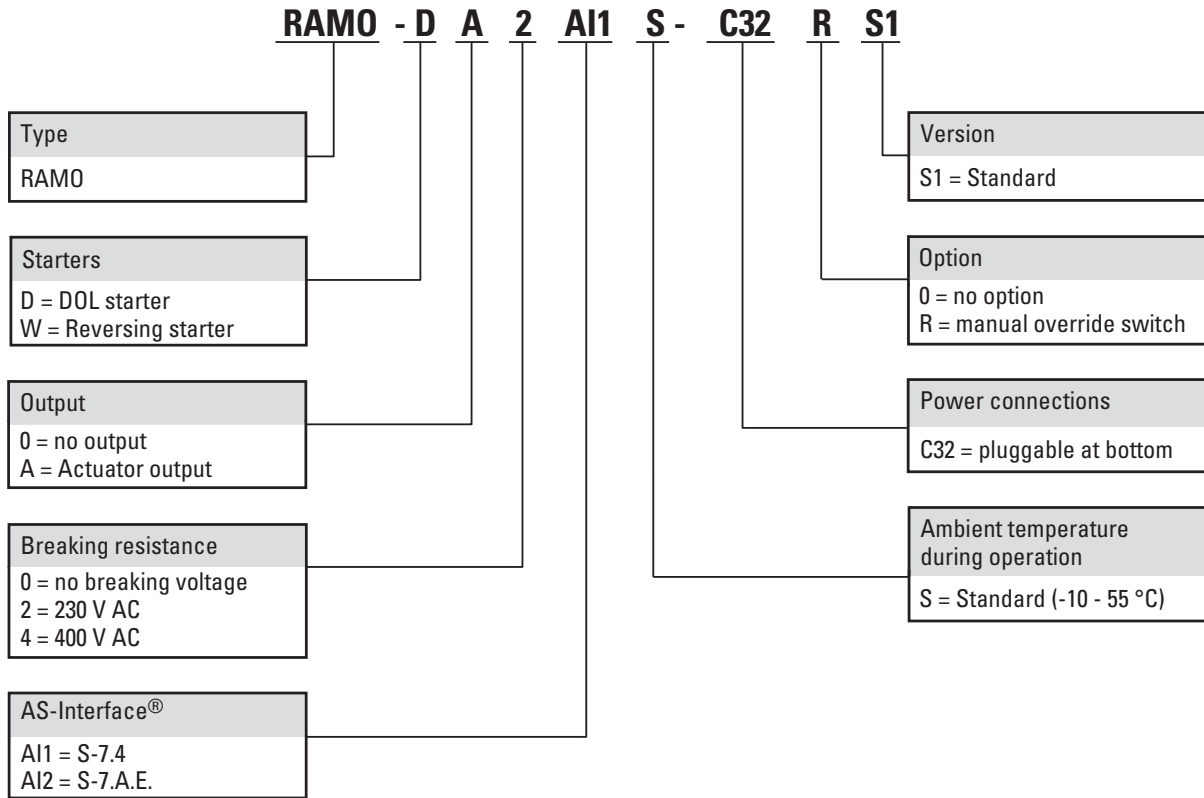

Frequency controlled motor starter RASP

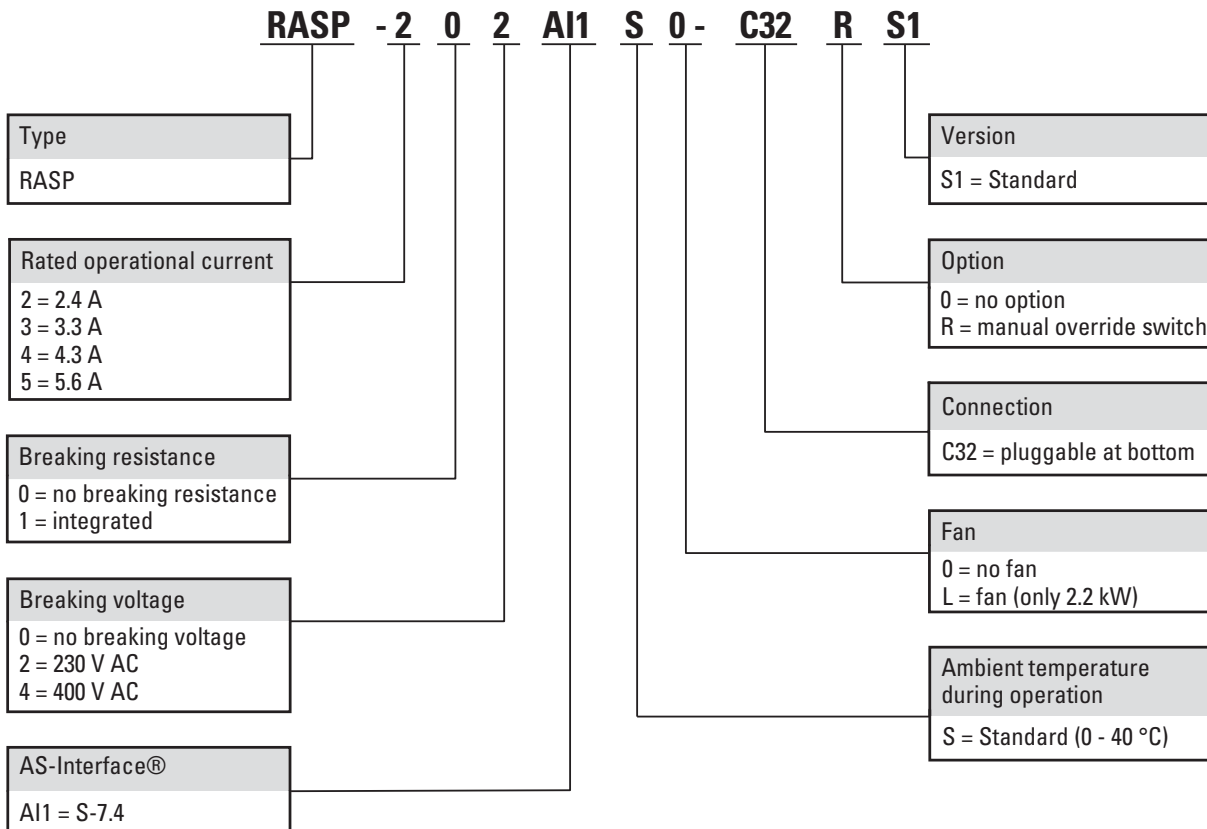

Ordering

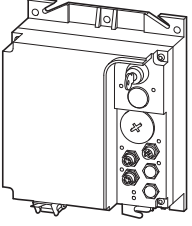
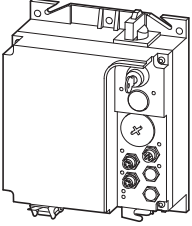
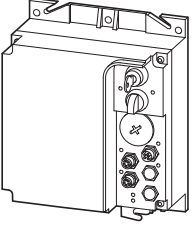
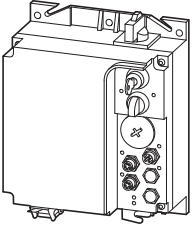
	Rated operational current ¹⁾ I _e A	assigned motor rating P ^{2),3)} P kW P HP		Control voltage external brake (50/60 Hz) ⁴⁾ V AC	Actuator output ⁵⁾ Number	AS-Interface profile cable		Part no. Article no.	Price see price list	Std. pack
						S-7.4 for 31 modules	S-7.4.E. for 62 modules			
motor starter										
Rated operational voltage 400 V AC, 3-phase Mains voltage (50/60Hz) U _{LN} 380 (-10%) - 480 (+10%) V										
DOL starters										
	6.6	0,09 - 3	0,125 - 3	-	-	✓	-	RAMO-D00AI1S-C320S1 150150		1 off
				230	-	✓	-	RAMO-D02AI1S-C320S1 150152		
				230	-	-	✓	RAMO-D02AI2S-C320S1 171776		
				230	1	✓	-	RAMO-DA2AI1S-C320S1 164321		
				400	-	✓	-	RAMO-D04AI1S-C320S1 169799		
				400	-	-	✓	RAMO-D04AI2S-C320S1 171778		
				400	1	✓	-	RAMO-DA4AI1S-C320S1 169800		
with manual override switch										
	6.6	0,09 - 3	0,125 - 3	-	-	✓	-	RAMO-D00AI1S-C32RS1 150158		1 off
				230	-	✓	-	RAMO-D02AI1S-C32RS1 150160		
				230	-	-	✓	RAMO-D02AI2S-C32RS1 171782		
				400	-	✓	-	RAMO-D04AI1S-C32RS1 169801		
				400	-	-	✓	RAMO-D04AI2S-C32RS1 171784		
Reversing starter with selector switch REV - OFF - FWD										
	6.6	0,09 - 3	0,125 - 3	-	-	✓	-	RAMO-W00AI1S-C320S1 150151		1 off
				230	-	✓	-	RAMO-W02AI1S-C320S1 150153		
				230	-	-	✓	RAMO-W02AI2S-C320S1 171777		
				230	1	✓	-	RAMO-WA2AI1S-C320S1 164322		
				230	1	-	✓	RAMO-WA2AI2S-C320S1 174473		
				400	-	✓	-	RAMO-W04AI1S-C320S1 169802		
				400	-	-	✓	RAMO-W04AI2S-C320S1 171779		
				400	1	✓	-	RAMO-WA4AI1S-C320S1 169803		
with manual override switch										
	6.6	0,09 - 3	0,125 - 3	-	-	✓	-	RAMO-W00AI1S-C32RS1 150159		1 off
				230	-	✓	-	RAMO-W02AI1S-C32RS1 150161		
				230	-	-	✓	RAMO-W02AI2S-C32RS1 171783		
				400	-	✓	-	RAMO-W04AI1S-C32RS1 169804		
				400	-	-	✓	RAMO-W04AI2S-C32RS1 171785		

Instructions

¹⁾ 0.3 - 6.6 adjustable

²⁾ for normal internally and externally ventilated 4 pole, three-phase asynchronous motors with 1500 rpm⁻¹ at 50 Hz or 1800 min⁻¹ at 60 Hz

³⁾ at 400 V, 50 Hz

at 440 - 480 V, 60 Hz



⁴⁾ for actuation of motors with mechanical brake

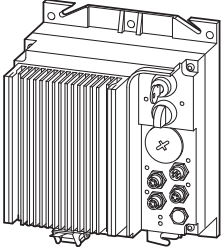
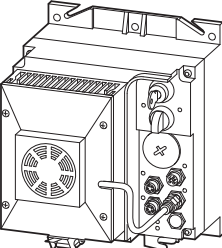
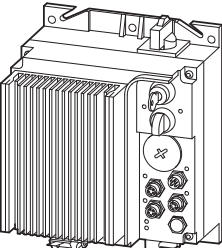
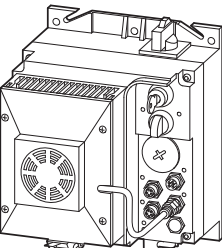





⁵⁾ Operation with external 24V DC supply

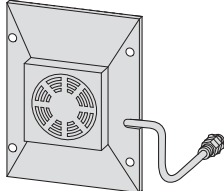
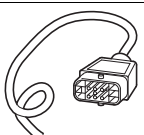
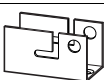
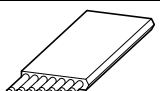
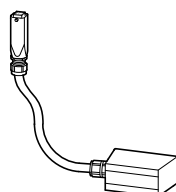

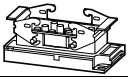

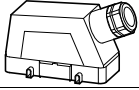
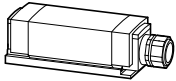
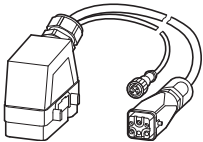
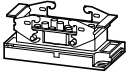
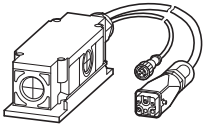
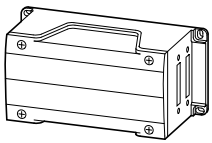

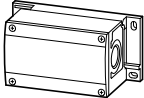
	Rated operational current ¹⁾		assigned motor rating P ³⁾		Control voltage external brake (50/60 Hz) ³⁾	Part no. Article no.	Price see price list	with braking resistance ⁴⁾		Std. pack
	I _e A	P kW	P HP	V AC				Part no. Article no.	Price see price list	
Speed controller										
Rated operational voltage 400 V AC, 3-phase Mains voltage (50/60Hz) U _{LN} 380 (-10%) - 480 (+10%) V AS-Interface profile cable S-7.4 for 31 modules										
	2.4	0.75	1	-	RASP-200AI1S0-C320S1 150168	RASP-210AI1S0-C320S1 150172				1 off
				230	RASP-202AI1S0-C320S1 150176	RASP-212AI1S0-C320S1 150180				
				400	RASP-204AI1S0-C320S1 169805	RASP-214AI1S0-C320S1 169809				
	3.3	1.1	1.5	-	RASP-300AI1S0-C320S1 150169	RASP-310AI1S0-C320S1 150173				
				230	RASP-302AI1S0-C320S1 150177	RASP-312AI1S0-C320S1 150181				
				400	RASP-304AI1S0-C320S1 169806	RASP-314AI1S0-C320S1 169810				
	4.3	1.5	2	-	RASP-400AI1S0-C320S1 150170	RASP-410AI1S0-C320S1 150174				
				230	RASP-402AI1S0-C320S1 150178	RASP-412AI1S0-C320S1 150182				
				400	RASP-404AI1S0-C320S1 169807	RASP-414AI1S0-C320S1 169811				
	5.6	2.2	3	-	RASP-500AI1SL-C320S1 150171	RASP-510AI1SL-C320S1 150175				
				230	RASP-502AI1SL-C320S1 150179	RASP-512AI1SL-C320S1 150183				
				400	RASP-504AI1SL-C320S1 169808	RASP-514AI1SL-C320S1 169812				
with manual override switch										
	2.4	0.75	1	-	RASP-200AI1S0-C32RS1 150200	RASP-210AI1S0-C32RS1 150204				1 off
				230	RASP-202AI1S0-C32RS1 150208	RASP-212AI1S0-C32RS1 150212				
				400	RASP-204AI1S0-C32RS1 169813	RASP-214AI1S0-C32RS1 169817				
	3.3	1.1	1.5	-	RASP-300AI1S0-C32RS1 150201	RASP-310AI1S0-C32RS1 150205				
				230	RASP-302AI1S0-C32RS1 150209	RASP-312AI1S0-C32RS1 150213				
				400	RASP-304AI1S0-C32RS1 169814	RASP-314AI1S0-C32RS1 169818				
	4.3	1.5	2	-	RASP-400AI1S0-C32RS1 150202	RASP-410AI1S0-C32RS1 150206				
				230	RASP-402AI1S0-C32RS1 150210	RASP-412AI1S0-C32RS1 150214				
				400	RASP-404AI1S0-C32RS1 169815	RASP-414AI1S0-C32RS1 169819				
	5.6	2.2	3	-	RASP-500AI1SL-C32RS1 150203	RASP-510AI1SL-C32RS1 150207				
				230	RASP-502AI1SL-C32RS1 150211	RASP-512AI1SL-C32RS1 150215				
				400	RASP-504AI1SL-C32RS1 169816	RASP-514AI1SL-C32RS1 169820				



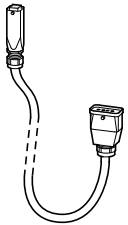
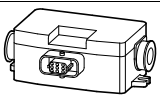

Instructions

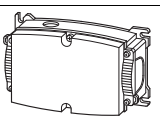
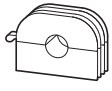
- 1) Rated operational current at an operating frequency of 6 kHz and an ambient air temperature of +40 °C
- 2) for normal internally and externally ventilated 4 pole, three-phase asynchronous motors with 1500 rpm⁻¹ at 50 Hz or 1800 min⁻¹ at 60 Hz
- 3) at 400 V, 50 Hz
at 440 - 480 V, 60 Hz
- 4) for actuation of motors with mechanical brake
- 5) integrated brake chopper with braking resistance for dynamic braking

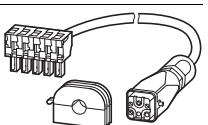
Description	For use with	Part no. Article no.	Price see price list	Std. pack	Instructions	
Communications						
Operating unit for setting the device parameters						
	with non-volatile parameter memory for copying parameter sets Equipment supplied: including 1 m connection cable with RJ45 connectors	RASP	RASP-KEY-S1 156644	1 off	-	
Programming cable for connecting the device to the PC						
	For configuring the device's parameters with the MaxConnect computer program with RJ 45 plug and USB plug	Length 3.4 m RASP	MXM-CBL-3M4-USB 153448	1 off	-	
Device fans						
RASP device fan for operation at high temperatures without derating						
	Power supply and control via RASP through M12 plug connector Enhanced cooling for ambient temperatures of up to +55 °C for RASP-2..., RASP-3..., and RASP-4... Spare part for RASP-5...	RASP	RASP-FAN-S1 156643	1 off	-	
Motor feeder						
Motor cable for connecting the motor starter to the motor						
	halogen free, 8 x 1.5 mm ² , plastic plug	Length 2 m	RAMO	RAMO-CM1-2M0 164282	1 off	-
		5 m	RAMO	RAMO-CM1-5M0 164283	1 off	-
		10 m	RAMO	RAMO-CM1-10M 164284	1 off	-
	halogen free, screened, 4 x 1.5 mm ² + 2 x (2 x 0.75 mm ²), plastic plug	2 m	RASP	RASP-CM1-2M0 164285	1 off	-
		5 m	RASP	RASP-CM1-5M0 164286	1 off	-
	Locking brackets for the safe isolation of the motor cables from power					
	For motor cables and motor plugs, disconnection device to EN 60204-1	RAMO-CM1... RASP-CM1...	SET-M-LOCK 272085	1 off	For padlocks with hasp thickness up to 8 mm	
Power supply at flat cable RA-C1						
Flat cable for 400 V AC/24 V DC decentralized power supply or AS-Interface						
	halogen free, 7 x 4 mm ²	RA-C1...	RA-C1-7X4HF 230860	100 runn. m	Paint film contaminant/ silicon-free	
Power connection cable for connecting the device with the 400 V AC flexible busbar junction						
	with power plug and plug for flexible busbar junction, halogen-free, 5 x 1.5 mm ²	RAMO RASP RA-C1-PLF	RA-C3/C1-1,5HF 290210	1 off	-	

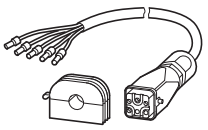
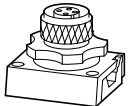
Description	For use with	Part no. Article no.	Price see price list	Std. pack	Instructions
Power supply at flat cable RA-C1					
Flexible busbar junction 400 V AC/24 V DC Connection socket for power connection cable					
 Insulation piercing terminals, terminal socket with lock mechanism	RA-C1-7X4HF RA-C3/C1-1,5HF	RA-C1-PLF 290188		5 off	-
Protection cover for protecting the 400 V AC/24 V DC flexible busbar junction					
 -	RA-C1-PLF	RA-C1-COV 254693		10 off	-
Plug connector for 400 V AC/24 V DC flexible busbar junction					
 Plug insert with hood	RA-C1-PLF	RA-C1-VP-PLM 231574		5 off	Order cable gland V-M25 separately.
Distributor module for feeding the 400-V-AC/24-V-DC of the ribbon cable with a round cable					
 Termination with piercing screws, 2 x V-M25 and 2 x V-M20 knockout plates, connection module with spring-loaded terminals, connection of round cables up to 4 mm ² .	RA-C1-7X4HF	RA-C1-AM-7 290214		6 off	Order cable gland V-M25 or V-M20 separately.
Power/AS-Interface connection cable for connecting the device with the 400 V AC AS-Interface flexible busbar junction					
 Double cable with outgoer plug (flexible busbar end) and M12 plug and power plug (device end)	RAMO RASP RA-C1-PLF1	RA-C1-PLM/C3-1M5 112624		1 off	Can be used when AS-Interface implemented in flat cable.
400 V AC/AS-Interface flexible busbar junction Connection socket for power/AS-Interface cable					
 Insulation piercing terminals, terminal socket with lock mechanism	RA-C1-7X4HF RA-C1-PLM/ C3-1M5	RA-C1-PLF1 116904		1 off	Can be used when AS-Interface implemented in flat cable.
Power/AS-Interface connection cable For connecting the device with 400 V AC/24 V DC/AS-Interface flexible busbar					
 Double cable with connection module (flexible busbar end) and M12 plug as well as power plug (device end), termination with piercing screws, knockouts Length 1.5 m	RAMO RASP RA-C1-7X4HF	RA-C1-AM/C3-1M5 112625		1 off	Can be used when AS-Interface implemented in flat cable.
Distributor module for the 400V AC feeding to the ribbon cable with a round cable					
 With 3 flexible busbar inputs and 2 round cable inputs Connection of round cables 4 mm ²	RA-C1-7X4HF	RA-C1-VM-7 264244		2 off	Order V-M25/V-M20 cable gland and RA-C1-DF bushing separately.
Flexible busbar bushing for bushing for flat cable in distributor module or control cabinet					
 -	RA-C1-VM-7	RA-C1-DF 264243		10 off	-
Distributor module 24 V DC control voltage is taken from the ribbon cable					
 Termination with piercing screws, connection sockets with screw contacts	RA-C1-7X4HF	RA-C1-VP-AM-2 264315		5 off	Order cable gland V-M20 separately
Flexible busbars for fastening the ribbon cable					
 -	RA-C1-7X4HF	RA-C1-FIX 272086		100 off	One set with 100 clips.

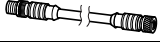
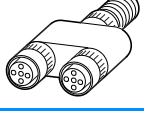
Description	Length m	For use with	Part no. Article no.	Price see price list	Std. pack	Instructions
Power supply at flat cable RA-C1						
End-piece for terminating the ribbon cable						
	-	RA-C1-7X4HF	RA-C1-END1 290189		10 off	-
Tools						
	For cutting flat cable	RA-C1-7X4HF	RA-C1-CUT 254690		1 off	-
	for removing casing at the ends of the flat cable	RA-C1-7X4HF	RA-C1-AZ-4 272087		1 off	A standard engineer's pliers is required.
Power supply at round cable RA-C2						
Power connection cable for connecting the device with the round cable junction						
	with power plug and plug for round cable junction, halogen-free, 5 x 1.5 mm ²	1.5	RAMO RASP RA-C2-S1-4	RA-C3/C2-1,5HF 290211	1 off	-
Round cable junction Connection socket for power connection cable						
	for 7 x 2.5/4 mm ² , 400 V AC and 24 V DC, termination with insulation piercing technology, cable fixing with metal screws, pre-wired socket insert, suitable for cable outer diameters 10 - 13 mm.		RA-C3/C2-1,5HF	RA-C2-S1-4 257830	1 off	Equipment supplied: 1 pairs of gaskets for these cable diameters, 1 lock mechanism.
Blanking plug for closing the last round cable junction in the power line						
	-	RA-C2-S1-4	RA-C2-SBL 265357		10 off	One set with 10 blanking plugs.
Power supply at round cable RA-C4						
Round cable junction Connection socket for power cables from 2.5 - 6 mm²						
	T junction via spring-cage terminal, 1.5 to 6 mm ² and/or plug connection of 0.5 - 4 mm ² , Enclosure IP65		RA-C4-PPB/ C3-1M5 RA-C4-X/ C3-1M5	RA-C4-PB65 116905	1 off	Enclosure opening gaskets are not included as standard
Gasket Slotted enclosure bushing seal						
	for Ø 11 - 13 mm EPDM round cable, silicon free and halogen free, IP65		RA-C4-PB65	RA-C4-D13 116907	10 off	-
	for Ø 13 - 15 mm EPDM round cable, silicon free and halogen free, IP65		RA-C4-PB65	RA-C4-D15 116908	10 off	-
	for Ø 15 - 17 mm EPDM round cable, silicon free and halogen free, IP65		RA-C4-PB65	RA-C4-D17 116909	10 off	-
Blanking plug for closing off unused housing openings						
	Enclosure seal, closed, EPDM, silicon free and halogen free, IP65		RA-C4-PB65	RA-C4-D0 116960	10 off	One set with 10 blanking plugs.
Power connection cable for connecting the device with the round cable junction						
	Cable 5 x 1.5 mm ² , halogen-free, with RA-C4-PPB plug for round cable junction, power plug and gasket IP65	1.5	RAMO RASP RA-C4-PB65	RA-C4-PPB/C3-1M5 116962	1 off	-

Description	Length m	For use with	Part no. Article no.	Price see price list	Std. pack	Instructions
Power connection cable for user assembly for connecting the device with the round cable junction 	1.5	RAM0 RASP RA-C4-PB65	RA-C4-X/C3-1M5 116961		1 off	-
AS-Interface connection and sensors						
AS-Interface link M12 connection socket for AS-Interface connection cable 		RAM0 RASP	ZB2-100-AZ1 082667		1 off	-
24V/AS-Interface connection cable for supplying the device with 24 V/AS-Interface 	1	RAM0 RAM0	RA-XAZ2-1M 292253		1 off	-
AS-Interface connection cable for connecting the device with AS-Interface junction 	1	RAM0 RASP	RA-XM12-1M 272057		1 off	Pins 1, 3, 4 are assigned
Y connector For connecting up to 2 sensors per M12 socket 	-	RASP	RA-XM12-Y 290424		1 off	-
Spare keys						
for AUTO - OFF/RESET - HAND key-switches 		RAM0 RASP	M22-ES-MS1 216416		5 off	-

The Rapid Link 4.0 electronic drive system enables remote and flexible installation in the direct proximity of the drive unit. The entire system is designed with protection to IP65. All electrical connections (mains voltage, motor feeder, sensors) are implemented simply with the standard connectors that are primarily used in materials handling applications.

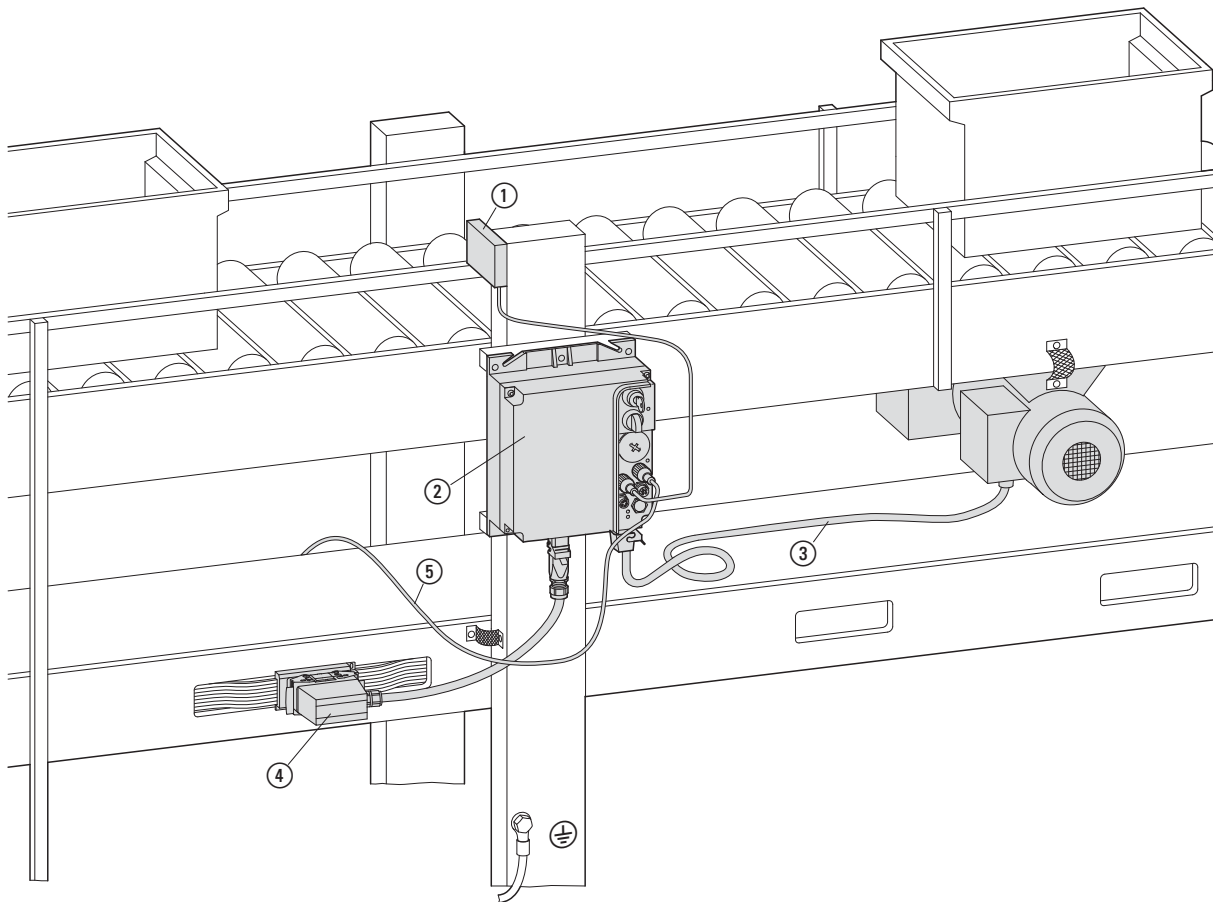

- ① Sensor (light barriers)
- ② RAMO
- ③ Motor connection cable
- ④ Mains connection on power bus
- ⑤ AS-Interface

Motor starter selection

All motor starters (RAMO, RASP) can provide electronic motor protection and the additional connection of temperature sensors (thermistor, ThermoClick, PTC). The motor starters are available in the following variants, with or without a lockable repair switch (mains transfer switch):

- RAMO-D, electronic DOL starter for one operating direction.
- RAMO-W, electronic reversing starter (two operating directions).
- RASP, frequency-controlled motor starter with several speeds for two operating direction in assigned ratings.

Electrical mains connection

The motor starters can be connected to and operated on 400 V three-phase, star point-earthed AC supply systems (in accordance with IEC 60364) without any restriction. The neutral conductor must be connected for motor starter variants that actuate a 230 V motor brake.

Safety and protective device

The power bus must have short-circuit protection. The length of the power bus depends on the upstream group protection. Calculations for design examples are provided in the Rapid Link manual (MN03406003Z):

- PKZM0-25 motor-protective circuit-breaker, max. approx. 40 m.
- FAZ C25/3 miniature circuit-breaker, max. approx. 60 m.
- PKE32/XTU-32 system protective circuit-breaker, 50 m to 220 m.

The group protective devices listed here protect:

- the power bus from overloads and short-circuits.
- the spur lines to the motor starter (RAMO, RASP) from overloads and short-circuits.
- the motor feeder of the RAMO

On the RASP frequency-controlled motor starter, the motor feeder is protected by the internal variable frequency drive.

When using residual current devices, a Type B AC/DC sensitive residual current circuit-breaker must be used with the RASP frequency-controlled motor starter.

EMC compliance

All motor starters observe the required EMC limit values when connected as specified. The RASP frequency-controlled motor starter must be provided with a shielded motor cable (RASP-CM1-...) and installed with the specified EMC measures. The internal RFI filter then allows operation in accordance with category C3 in the second environment.

Terminal Models

The electrical connection in the power section (mains voltage, motor feeder) is implemented with plug-in terminals in the base.

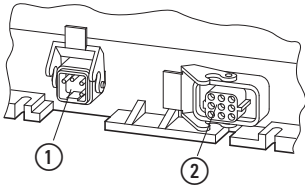

- ① 5-pole power connector for connecting the 3 AC 400 V mains voltage, (N), PE.
- ② 8-pole motor feeder socket as per DESINA specification.

By rotating the base 90 degrees, connection is also possible from the right or left. This makes it possible to keep the operating and connection area and the heat sink on the RASP in the preferred vertical position.

Example RASP:

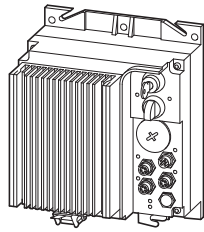

Connection from below (standard)

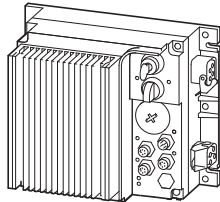

Connection from the right (90 degree rotation of the base to the left)

Three installation systems are available for connecting the power plug to the mains:

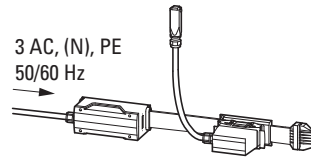

RA-C1, flat cable system

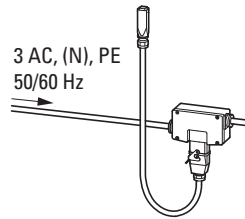

RA-C2, round cable system with plug connectors

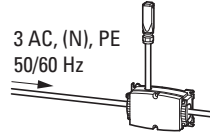

RA-C4, round cable system with contact connectors

Device variants with a repair switch (RAMO-...-C32R..., RASP-...-C32R...) ensure that the drive can be isolated locally from the power supply for repair or maintenance work, even when it is still connected. A padlock can be used to secure the repair switch.

The 8-pole motor feeder can be used to connect:

- a three-phase AC motor (U1, V1, W1, PE),
- a motor brake (B1, B2) with a control voltage of 230 V AC or 400 V AC,
- a thermistor or temperature switch (ThermoClick). These connection cables (T1, T2) can at the same time be used to monitor the motor cable and the connection of the motor feeder plug.

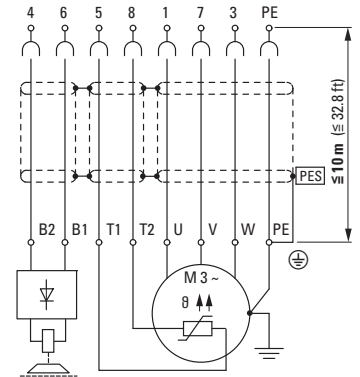

Example: Motor feeder with shielded motor cable on the RASP

Control level

The control level features a selector switch (key switch) for selecting automatic mode and manual mode locally. The RAMO-W and RASP motor starters are also provided with a selector switch for reversing the motor direction in manual mode.

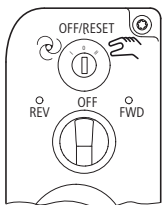

The automatic mode and the control voltage power supply are implemented via the AS-Interface. All connections in the control level (AS-i, sensors etc.) are implemented with M12 plug connectors. For this the M12 connectors just have to be fitted on [1] and rotated to secure them [2] (see illustration below).

The sensor inputs (I3, I4) enable the Rapid Link motor starters to execute sensor-controlled functions immediately and independently of PLC and bus cycle times:

- Interlocked manual operation,
- Quick Stop,
- Rotation direction change (on RAMO-W and RASP),
- Controlled speeds (only RASP)

On the RAMO-DA... and RAMO-WA... a 24 V DC output (max. 1 A, O3) also makes it possible to control external actuators (valves, couplings, indicator lights) directly.

The functions are selected directly on the motor starter via microswitches. On the RASP additional settings (variable frequency drives) can be made from a hand-held terminal or from the parameter software.

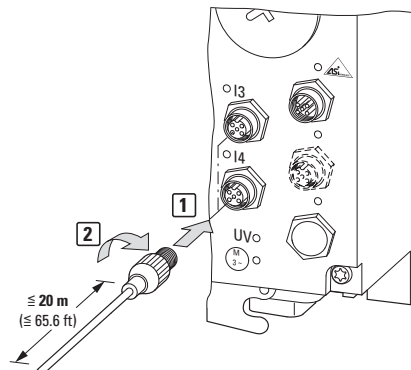

Engineering

Block diagram DOL starter RAMO-D

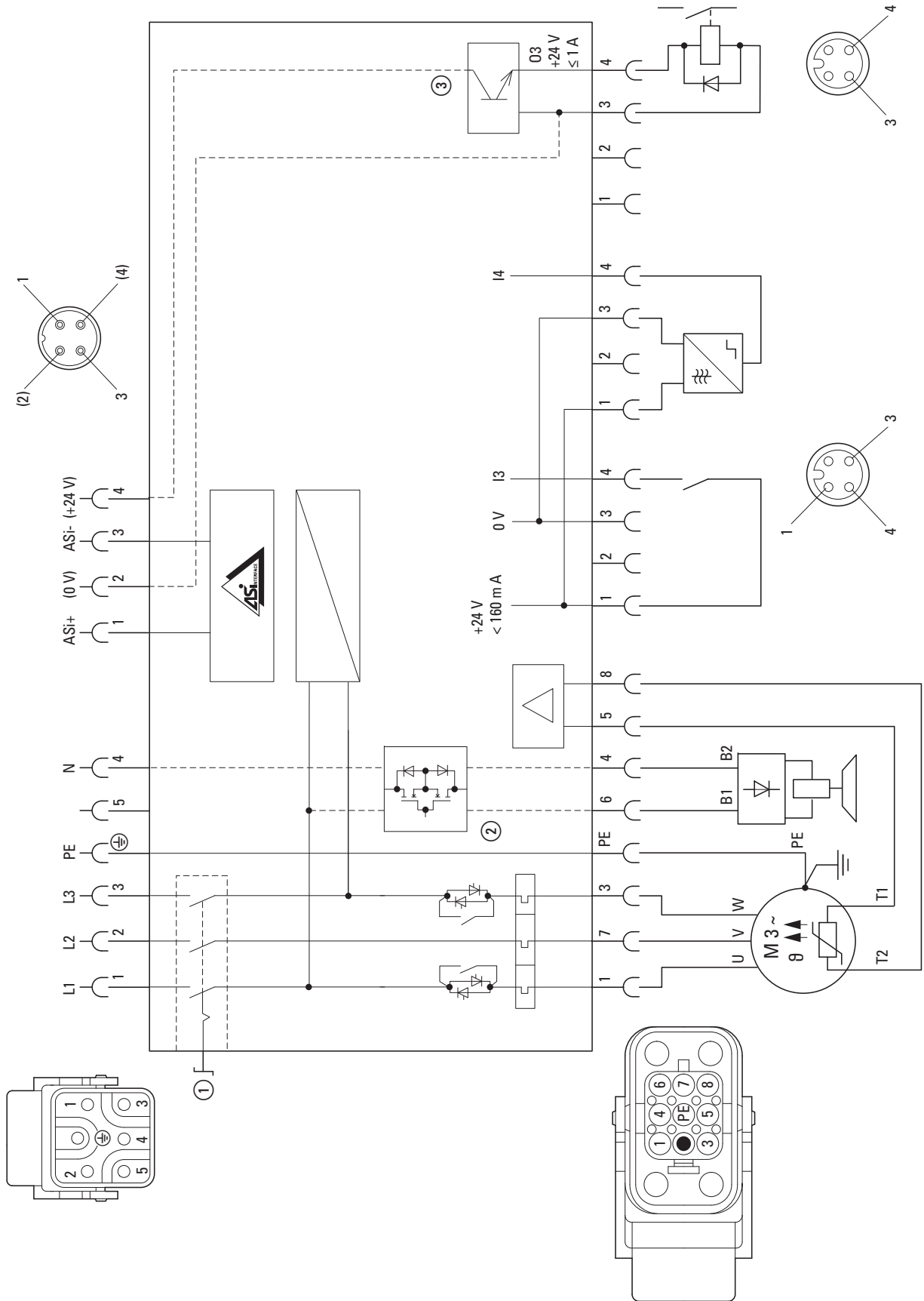

Optional versions:

- ① Repair and maintenance switch RAMO-D...-C32R...
- ② Activation of external brake: 230/277 V at RAMO-Dx2... or 400/480 V at RAMO-Dx4...
- ③ actuator output, RAMO-DA...

Block diagram RAMO-W reversing starter

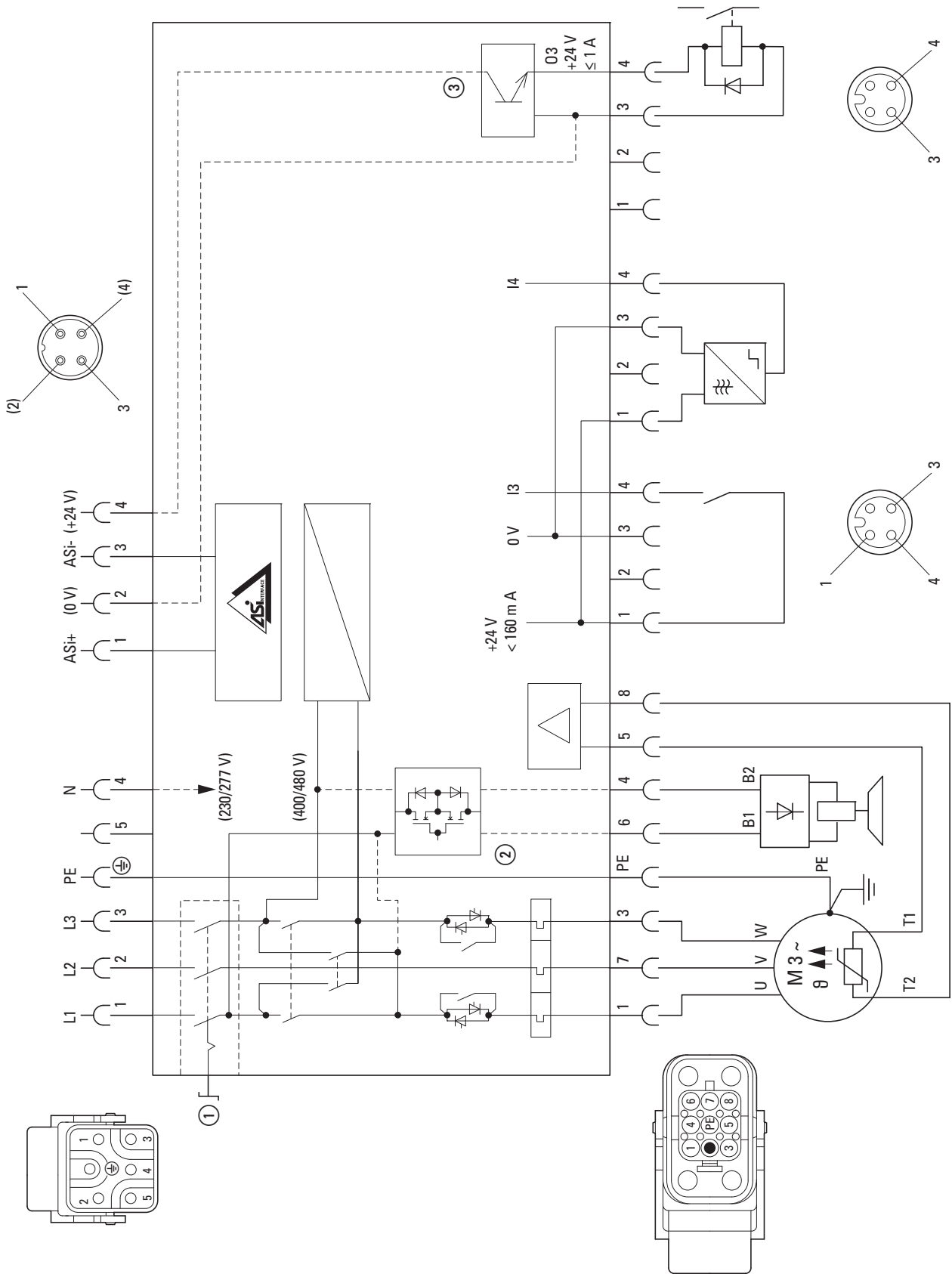

Optional versions:

- ① Repair and maintenance switch RAMO-W...-C32R...
- ② Actuation of external brake: 230/277 V on RAMO-Dx2... or 400/480 V on RAMO-Dx4...
- ③ actuator output, RAMO-WA...

Block diagram RASP with 230V brake

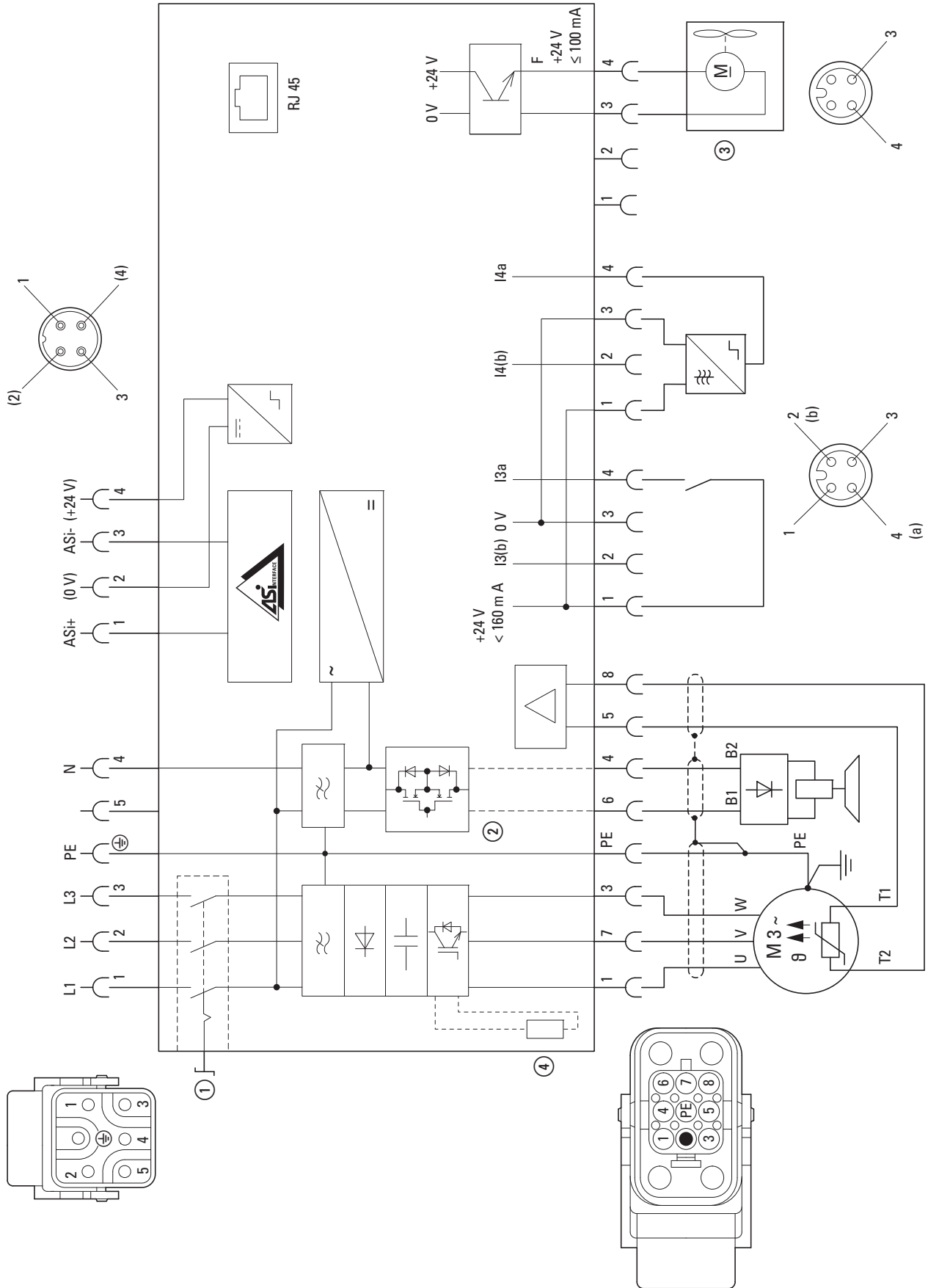

Optional versions:

- ① Repair and maintenance switch, RASP-...C32R...
- ② Activation of external brake (230 V), RASP-...xx2...
- ③ Device fan, RASP-...L-C32...
- ④ internal braking resistance, RASP-x1...

Notes:

Y connector RA-XM12-Y is required in order to connect 4 sensors (I3a, I3b/I4a, I4b) (→ accessory)

Block diagram RASP with 400V brake

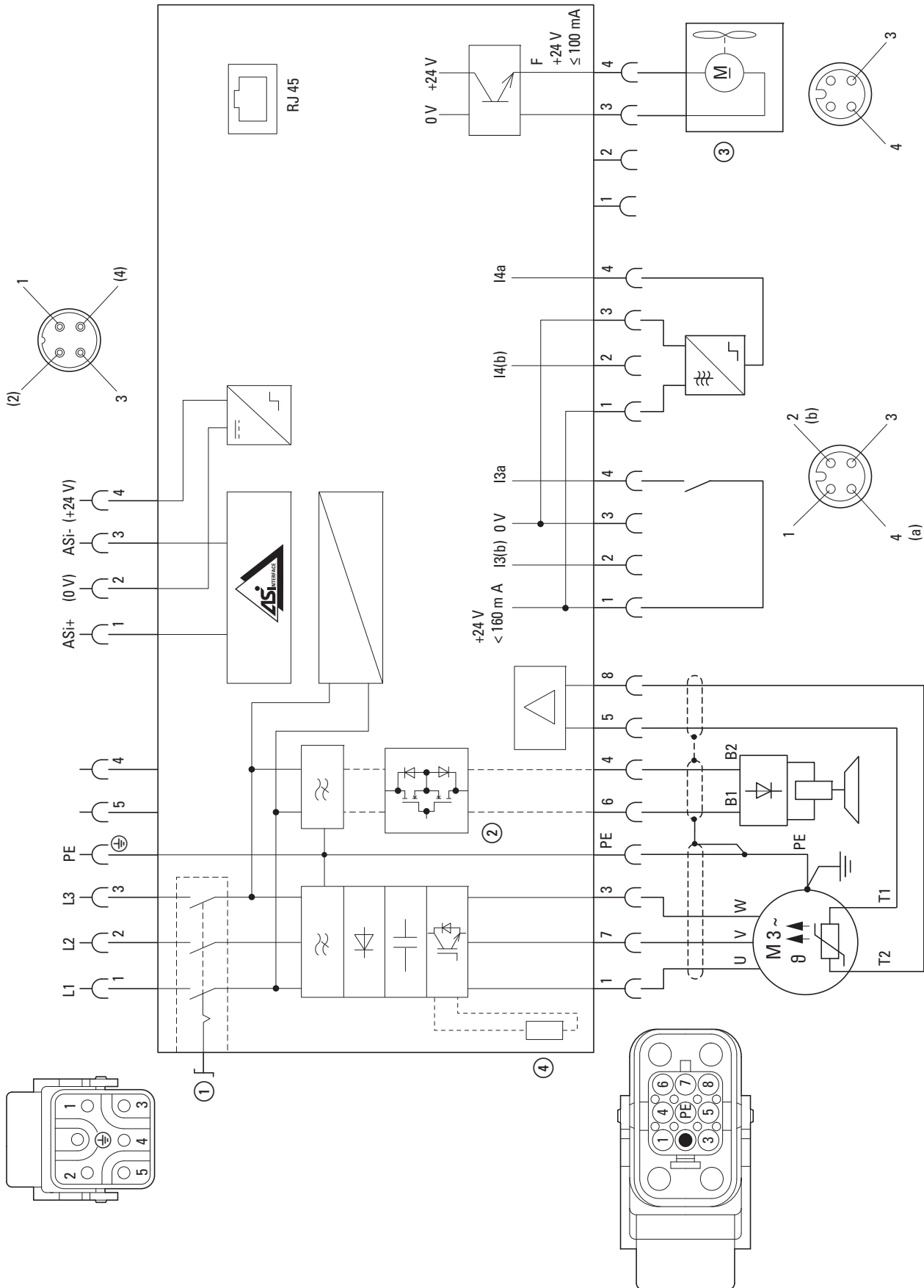

Optional versions:

- ① Repair and maintenance switches, RASP-...C32R...
- ② Activation of external brake (400 V), RASP-...xx4...
- ③ Device fan, RASP-...L-C32...
- ④ internal braking resistance, RASP-x1...

Notes:

Y connector RA-XM12-Y is required in order to connect 4 sensors (I3a, I3b/I4a, I4b) (→ accessory)



SmartWire-DT – Cost-optimized Communication for Switchgear

Manufacturers of machines and systems strive to achieve a balance between the maximum level of functionality and cost optimization. SmartWire-DT is a communication system for industrial switchgear based on the concept of continued development in the control panel and peripherals: from control through to protection and switching, and extending to driving, operation and monitoring. One technology from which you will profit, now and in the future.

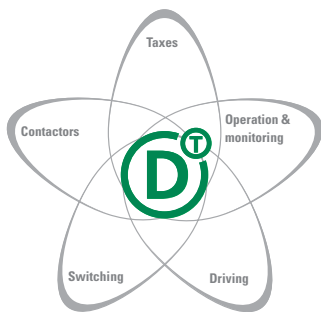

Drives and soft starters – communicate with SmartWire-DT

Being able to use a controller to directly access all the parameters in soft starters, variable speed starters, and variable frequency drives via SmartWire-DT is the epitome of ease of operation. For example, this enables users to easily read and overwrite setpoints, as well as to retrieve extended status, error, and diagnostic messages directly and establish absolute data transparency. Moreover, easy-to-use SmartWire-DT plug-in units make installation fast and error-free, with the resulting connection including the control current supply for DS7 soft starters.

PowerXL DE1, DC1, and DA1 devices can be easily expanded with plug-in modules and connected to SmartWire-DT, with function blocks enabling simple communication with Eaton controllers (PLCs, HMIs). Moreover, more advanced communication is also possible based on the PROFIdrive profile and other profiles as well. This not only makes it possible to configure all drive parameters, but also provides advanced diagnostic options.



SmartWire-DT

System overview	146
-----------------	-----

Ordering

SmartWire-DT Gateways	148
SmartWire-DT accessories	148

SmartWire-DT HMI-PLC → Industrial Switchgear catalog	1	DE1 variable speed starter → page 10	10	SmartWire-DT plug connector → page 149	17
Data plug Sub-D 9 pole → Industrial Switchgear catalog	2	DC1 variable frequency drive → page 18	11	SmartWire-DT round cable, 8-pole → page 149	18
SmartWire-DT gateways → page 148	3	DA1 variable frequency drive → page 33	12	SmartWire-DT adapter for flat/round cable for top-hat rail mounting → page 149	19
SmartWire-DT blade terminal 8 pole → page 148	4	SmartWire-DT universal module, front mount → page 149	13	Soft starter DS7 < 32 A → page 103	20
SmartWire-DT flat ribbon cable 8 pole → page 148	5	SmartWire-DT control panel cable entry for flat to round cable → page 149	14	Soft starter DS7 > 32 A → page 103	21
SmartWire-DT external device plug 8 pole → page 148	6	SmartWire-DT plug connector → page 149	15	SmartWire-DT bus termination resistor for 8-pole flat band conductor → page 149	22
SmartWire-DT module → page 12	7, 8	RMQ-Titan surface-mounting enclosure with RMQ-Titan elements → Industrial Switchgear catalog	16	SmartWire-DT planning and ordering aid, SWD-Assist	23
Soft starter DS7 with electronic motor protection from PKE → Industrial Switchgear catalog	9				

Note: You can find the entire SmartWire-DT range of products by consulting our industrial main catalog or our online catalog at <http://ecat.moeller.net>

Features

SmartWire-DT HMI-PLC

- with SmartWire-DT master interface and PLC function
- Compact design with light plastic enclosures
- Wide selection of onboard interfaces
- 3.5" , 5.7" or 7" TFT-LCD screen

SmartWire-DT Gateways

- Connection of SmartWire-DT to field bus.
- Field bus address setting with dip switches
- Automatic baud rate detection
- Feeding the supply voltage for the SmartWire-DT modules
- Supplies the control voltage for the motor starter or contactor
- Configuration button for automatic addressing of the SmartWire-DT slaves.
- Support of up to 99 SmartWire-DT modules.

















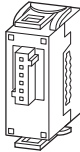

SmartWire-DT module

- Function element for connecting to RMQ-Titan pilot devices.
- Function element for connecting to DLM contactors
- Function element for connecting to PKZ/PKE motor-protective circuit-breakers
- Function module for connecting to NZM2,3,4 circuit-breakers
- Connection of digital and analog input/output modules
- DS7 Soft starter connection
- Function element for connecting to PowerXL DC1, DA1 variable frequency drives and DE1 variable speed starter

SmartWire-DT Assist (SWD-Assist)

- Easy creation of SmartWire-DT networks
- Integrated validity check
- Generation of ordering lists.
- Online-Functionality
 - Simple pre-commissioning
 - Configuration check and comparison
 - Display of parameters and diagnostics
 - easy diagnostics of SmartWire-DT slave
- Free download under: <http://downloadcenter.moeller.net>

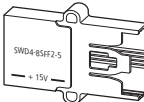









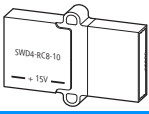

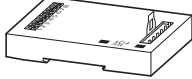

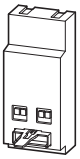

Ordering

Description	Baud Rates	Number of SmartWire-DT slaves	Part no. Article no.	Price see price list	Std. pack
SmartWire-DT Gateways					
Used to connect the SmartWire-DT communication system to industrial field bus systems. Powers SmartWire-DT modules and switchgear					
	For connection to PROFIBUS-DP field bus	up to 12 MBit/s	Max. 58	EU5C-SWD-DP 116308	1 off  
	For connection to CANopen® field bus	up to 1 MBit/s	Max. 99	EU5C-SWD-CAN 116307	
	For connection to the Ethernet-IP/MODBUS-TCP field bus	10/100 MBit/s	Max. 99	EU5C-SWD-EIP-MODTCP 153163	
	for connection to field bus PROFINET as PROFINET IO-Device	100 MBit/s	Max. 99	EU5C-SWD-PROFINET 170124	1 off  
Flat band conductor, 8 pole					
For connecting the SmartWire-DT modules within the control panel 8 pole					
	not ready-assembled		Length 100 m	SWD4-100LF8-24 116026	1 off  
	prefabricated with two blade terminals SWD4-8MF2		Length 3 m	SWD4-3LF8-24-2S 116027	
			Length 5 m	SWD4-5LF8-24-2S 116028	
			Length 10 m	SWD4-10LF8-24-2S 116029	
External device plugs					
	For connecting the ribbon cable to SmartWire-DT modules in the control panel			SWD4-8SF2-5 116022	10 off  
Link					
	For bridging open mounting locations for SWD4-8SF2-5 external device plugs Front fixing			SWD4-SEL8-10 116021	5 off  
Blade terminal					
	For connecting the ribbon cable to the gateway, power feeder module, coupling, SWD4-RC8-10 bus termination resistor			SWD4-8MF2 116023	10 off  
Coupling					
	To connect SWD ribbon cables over SWD4-8MF2 blade terminals			SWD4-8SFF2-5 116024	1 off  

Notes

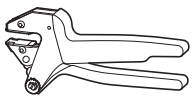
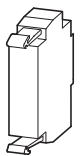

Information relevant for export to North America → Page 149

Description	Part no. Article no.	Price see price list	Std. pack						
Network terminator									
 <p>For the SmartWire-DT bus termination resistor on the SmartWire-DT ribbon cable</p>	SWD4-RC8-10 116020		1 off  						
Cable adapters									
 <p>SmartWire-DT cable adapter for connecting a ribbon cable (plug) to a round cable (terminal)</p>	SWD4-8FRF-10 121377		1 off  						
Switch cabinet bushing									
<p>For transition from SWD ribbon cable to SWD round cable SWD4-...LR8-24 Connection of ribbon cable with blade terminal SWD4-8MF2 8 pole double conductor run pluggable Additional control voltage feeder for the motor starter and contactors.</p>									
 <p>Connection round cable via socket</p>	SWD4-SFL8-20 121380		1 off  						
<p>Connection round cable via plug</p>	SWD4-SML8-20 121381								
SWD round cable									
<p>For laying the SmartWire-DT network outside of the control panel.</p>									
 <p>For connecting pilot devices in CI surface mounting enclosures 8 pole HK-S0-Li2YY, 8 mm diameter Length 50 m</p>	SWD4-50LR8-24 116030		1 off  						
Connectors for SWD round conductors									
 <p>8 pole socket Straight</p>	SWD4-SF8-67 116033		1 off  						
<p>8-pinplug connector Straight</p>	SWD4-SM8-67 116034								
 <p>8 pole socket 90° angled</p>	SWD4-SF8-67W 116035								
<p>8-pinplug connector 90° angled</p>	SWD4-SM8-67W 116036								
Tools for plugs									
 <p>Crimping tool for joining external device plugs and ribbon cable</p>	SWD4-CRP-1 116025		1 off						
<p>Crimping tool for making contacts with blade terminals and ribbon cables</p>	SWD4-CRP-2 116699								
Universal slave									
<p>for configured but not yet installed SmartWire-DT slaves Front mount</p>									
 <p>Configuration</p> <table border="1" data-bbox="359 1556 470 1624"> <tr> <td>1</td> <td>3</td> <td>2</td> </tr> <tr> <td>4</td> <td>6</td> <td>5</td> </tr> </table>	1	3	2	4	6	5	M22-SWD-NOP 147637		20 off  
1	3	2							
4	6	5							

Notes  **Information relevant for export to North America**

UL File No. E29184
UL Category Control No. NKCR
CSA File No. 2324643
CSA Class No. 3211-07
North America Certification UL listed, CSA certified

EU5C-SWD-PROFINET

UL File No. E221530
UL Category Control No. NRQA
CSA File No. UL report applies to both US and Canada
North America Certification UL listed, CSA certified

Full-load motor-running currents in amperes corresponding to various AC horsepower ratings

HP	110 - 120 V			220 - 240 V ^{a,b}			360 - 380 V		440 - 480 V			550 - 600 V		
	Single phase	Two phase	Three phase	Single phase	Two phase	Three phase	Single phase	Three phase	Single phase	Two phase	Three phase	Single phase	Two phase	Three phase
1/10	3.0	-	-	1.5	-	-	1.0	-	-	-	-	-	-	-
1/8	3.8	-	-	1.9	-	-	1.2	-	-	-	-	-	-	-
1/6	4.4	-	-	2.2	-	-	1.4	-	-	-	-	-	-	-
1/4	5.8	-	-	2.9	-	-	1.8	-	-	-	-	-	-	-
1/3	7.2	-	-	3.6	-	-	2.3	-	-	-	-	-	-	-
1/2	9.8	4.0	4.4	4.9	2.0	2.2	3.2	1.3	2.5	1.0	1.1	2.0	0.8	0.9
3/4	13.8	4.8	6.4	6.9	2.4	3.2	4.5	1.8	3.5	1.2	1.6	2.8	1.0	1.3
1	16.0	6.4	8.4	8.0	3.2	4.2	5.1	2.3	4.0	1.6	2.1	3.2	1.3	1.7
1-1/2	20.0	9.0	12.0	10.0	4.5	6.0	6.4	3.3	5.0	2.3	3.0	4.0	1.8	2.4
2	24.0	11.8	13.6	12.0	5.9	6.8	7.7	4.3	6.0	3.0	3.4	4.8	2.4	2.7
3	34.0	16.6	19.2	17.0	8.3	9.6	10.9	6.1	8.5	4.2	4.8	6.8	3.3	3.9
5	56.0	26.4	30.4	28.0	13.2	15.2	17.9	9.7	14.0	6.6	7.6	11.2	5.3	6.1
7-1/2	80.0	38.0	44.0	40.0	19.0	22.0	27.0	14.0	21.0	9.0	11.0	16.0	8.0	9.0
10	100	48.0	56.0	50.0	24.0	28.0	33.0	18.0	26.0	12.0	14.0	20.0	10.0	11.0
15	135	72.0	84.0	68.0	36.0	42.0	44.0	27.0	34.0	18.0	21.0	27.0	14.0	17.0
20	-	94.0	108	88.0	47.0	54.0	56.0	34.0	44.0	23.0	27.0	35.0	19.0	22.0
25	-	118	136	110	59.0	68.0	70.0	44.0	55.0	29.0	34.0	44.0	24.0	27.0
30	-	138	160	136	69.0	80.0	87.0	51.0	68.0	35.0	40.0	54.0	28.0	32.0
40	-	180	208	176	90.0	104	112	66.0	88.0	45.0	52.0	70.0	36.0	41.0
50	-	226	260	216	113	130	139	83.0	108	56.0	65.0	86.0	45.0	52.0
60	-	-	-	-	133	154	-	103	-	67.0	77.0	-	53.0	62.0
75	-	-	-	-	166	192	-	128	-	83.0	96.0	-	66.0	77.0
100	-	-	-	-	218	248	-	165	-	109	124	-	87.0	99.0
125	-	-	-	-	-	312	-	208	-	135	156	-	108	125
150	-	-	-	-	-	360	-	240	-	156	180	-	125	144
200	-	-	-	-	-	480	-	320	-	208	240	-	167	192
250	-	-	-	-	-	602	-	403	-	-	302	-	-	242
300	-	-	-	-	-	-	-	482	-	-	361	-	-	289
350	-	-	-	-	-	-	-	560	-	-	414	-	-	336
400	-	-	-	-	-	-	-	636	-	-	477	-	-	382
500	-	-	-	-	-	-	-	786	-	-	590	-	-	472

^{a)}To obtain full-load currents for 200 and 208 V motors, increase corresponding 220 - 240 V ratings by 15 and 10 percent, respectively.

^{b)}To obtain full-load currents for 265 and 277 V motors, decrease corresponding 220 - 240 V ratings by 13 and 17 percent, respectively.

Zitiert aus "Power Conversion Equipment - UL 508C, May 3, 2002".

Reproduced from UL 508 C, Power Conversion Equipment, 3rd edition (May 2, 2002) with permission of Underwriters Laboratories Inc.

Minimum fuse sizes for short-circuit protection of three-phase motors
The maximum value depends on the switching device or the overload relay.

Motor power			230 V			400 V			440 V			500 V			690 V		
			Motor rated operational current	Fuse		Motor rated operational current	Fuse		Motor rated operational current	Fuse		Motor rated operational current	Fuse		Motor rated operational current	Fuse	
A	Starting DOL	Y/Δ		A	Starting DOL		Y/Δ	A		Starting DOL	Y/Δ		A	Starting DOL		Y/Δ	A
kWh	cos φ	η (%)															
0.06	0.7	58	0.37	2	–	0.21	2	–	0.19	2	–	0.17	2	–	0.12	2	–
0.09	0.7	60	0.54	2	–	0.31	2	–	0.28	2	–	0.25	2	–	0.18	2	–
0.12	0.7	60	0.72	4	2	0.41	2	–	0.37	2	–	0.33	2	–	0.24	2	–
0.18	0.7	62	1.04	4	2	0.6	2	–	0.54	2	–	0.48	2	–	0.35	2	–
0.25	0.7	62	1.4	4	2	0.8	4	2	0.76	2	–	0.7	2	–	0.5	2	–
0.37	0.72	66	2	6	4	1.1	4	2	1	4	2	0.9	2	2	0.7	2	–
0.55	0.75	69	2.7	10	4	1.5	4	2	1.4	4	2	1.2	4	2	0.9	4	2
0.75	0.79	74	3.2	10	4	1.9	6	4	1.7	4	2	1.5	4	2	1.1	4	2
1.1	0.81	74	4.6	10	6	2.6	6	4	2.4	4	2	2.1	6	4	1.5	4	2
1.5	0.81	74	6.3	16	10	3.6	6	4	3.3	6	4	2.9	6	4	2.1	6	4
2.2	0.81	78	8.7	20	10	5	10	6	4.6	10	6	4	10	4	2.9	10	4
3	0.82	80	11.5	25	16	6.6	16	10	6	16	10	5.3	16	6	3.8	10	4
4	0.82	83	14.8	32	16	8.5	20	10	7.7	16	10	6.8	16	10	4.9	16	6
5.5	0.82	86	19.6	32	25	11.3	25	16	10.2	20	10	9	20	16	6.5	16	10
7.5	0.82	87	26.4	50	32	15.2	32	16	13.8	25	16	12.1	25	16	8.8	20	10
11	0.84	87	38	80	40	21.7	40	25	19.8	32	25	17.4	32	20	12.6	25	16
15	0.84	88	51	100	63	29.3	63	32	26.6	50	32	23.4	50	25	17	32	20
18.5	0.84	88	63	125	80	36	63	40	32.8	63	32	28.9	50	32	20.9	32	25
22	0.84	92	71	125	80	41	80	50	37	80	40	33	63	32	23.8	50	25
30	0.85	92	96	200	100	55	100	63	50	100	63	44	80	50	32	63	32
37	0.86	92	117	200	125	68	125	80	61	125	80	54	100	63	39	80	50
45	0.86	93	141	250	160	81	160	100	74	125	100	65	125	80	47	80	63
55	0.86	93	173	250	200	99	200	125	90	125	100	79	160	80	58	100	63
75	0.86	94	233	315	250	134	200	160	122	160	125	107	200	125	78	160	100
90	0.86	94	279	400	315	161	250	200	146	200	160	129	200	160	93	160	100
110	0.86	94	342	500	400	196	315	200	179	250	200	157	250	160	114	200	125
132	0.87	95	401	630	500	231	400	250	210	250	250	184	250	200	134	250	160
160	0.87	95	486	630	630	279	400	315	254	315	250	224	315	250	162	250	200
200	0.87	95	607	800	630	349	500	400	318	400	315	279	400	315	202	315	250
250	0.87	95	–	–	–	437	630	500	397	630	400	349	500	400	253	400	315
315	0.87	96	–	–	–	544	800	630	495	630	630	436	630	500	316	500	400
400	0.88	96	–	–	–	683	1000	800	621	800	800	547	800	630	396	630	400
450	0.88	96	–	–	–	769	1000	800	699	800	800	615	800	630	446	630	630
500	0.88	97	–	–	–	–	–	–	–	–	–	–	–	–	491	630	630
560	0.88	97	–	–	–	–	–	–	–	–	–	–	–	–	550	800	630
630	0.88	97	–	–	–	–	–	–	–	–	–	–	–	–	618	800	630

Instructions
The rated motor currents apply to normal internally and surface-cooled three-phase motors with 1500 rpm.
DOL starting: Starting current max. 6 × rated motor current.
Starting time max. 5 s.
Y/Δ-start: Starting current max. 2 × motor rated current.
Starting time max. 15 s.
Set overload relay in line to 0.58 × motor rated current.

Fuse ratings at Y/Δ starting apply also to three-phase slipring motors.
For higher rated currents, starting currents and/or longer starting times, larger fuses will be required. Table applies for time delay and gL fuses (VDE 0636)

**For LV h.b.c. fuse with aM characteristics
the fuse should be equal to the rated operational current.**

Drives engineering selection criteria

Each drive task requires a drive motor. The speed, torque and controllability of each motor must fulfill the requirements of the task. The following generally applies: the application determines the drive. The drive motor most frequently used worldwide in industrial plants and large buildings is the 3-phase asynchronous motor. Its robust and simple construction as well as its high degrees of protection and standard types are the main features of this inexpensive electric motor.

Motor connection

When connecting a 3-phase motor to the mains supply, the data on the rating plate of the motor must correspond to the mains voltage and frequency. The standard connection is implemented via six screw terminals in the terminal box of the motor and with two types of circuit, the star connection and the delta circuit, depending on the mains voltage.

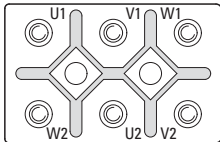

The rotation direction of a motor is always determined by directly looking at the drive shaft of the motor (from the drive end). On motors with two shaft ends, the driving end is denoted with D (= Drive), the non-driving end with N (= No drive).

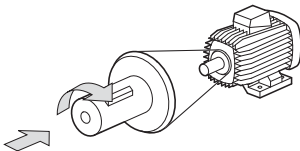

Regardless of the circuit type and the type of three-phase asynchronous motor, the connections must be labeled, so that their alphabetical sequence (e.g. U1, V1, W1) corresponds with the order of the mains voltage phase sequence (L1, L2, L3) and causes the motor to rotate clockwise.

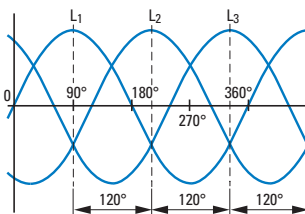

On the three-phase asynchronous motor, three windings are arranged offset from each other by 120°/p (p = number of pole pairs). To generate a rotating field in the motor, an alternating voltage is applied to each phase in turn at a time delay of 120°.

The effect of inductance causes the rotation field and torque to be formed in the rotor winding. The speed of the motor thus depends on the number of pole pairs and the frequency of the supply voltage. The operating direction can be reversed by swapping over two of the supply phases.

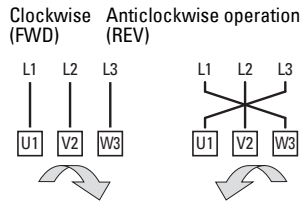

FWD = forward run (clockwise rotation field)
REV = reverse run (anticlockwise rotation field)

Information on the rating plate

The electrical and mechanical rating data of the motor must be stated on its rating plate (IEC 34-1, VDE 0530). The data on the rating plate describes the stationary operation of the motor in the area of its operating point (MN, e.g. at 400 V and 50 Hz). The operational data is unstable in the motor start phase. The following examples show the rating plates for two motors with a motor shaft output of 4 kW and the respective connection circuits on a 3-phase AC network with 400 V and 50 Hz.

Star circuit

230 / 400 V	Δ / Y	14.5 / 8.5 A
S1	4.0 kW	cos φ 0.82
1410 min ⁻¹		50 Hz
IP 54		Iso. KI F

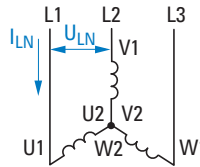

$$U_{LN} = \frac{\sqrt{3}}{3} \times U_W, I_{LN} = I_W$$

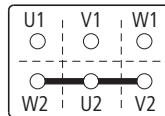

- With the specified 230/400 V voltage, this motor must be connected to the 3-phase system (U_{LN} = 400 V) in a star-connected circuit.
- The voltage of each motor winding is designed for 230 V. The windings must therefore be connected in sequence to the phase voltage (400 V).
- The three winding phases (W2-U2-V2) are configured in the terminal box to the so-called star point. The voltage of the individual phases to the star point is 230 V (= U_W).

Startup characteristics

The following figure shows the characteristic startup curves of a 3-phase asynchronous motor.

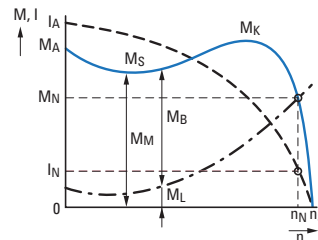

- I_A: Starting current
- I_N: Rated operational current at the operating point
- M_A: Starting torque
- M_B: Accelerating torque (M_M > M_L)
- M_K: Breakdown torque
- M_L: Load torque
- M_M: Motor torque
- M_N: Rated load torque, (stable operating point, intersection point of the 3-phase speed torque characteristic with the load characteristic)
- M_S: Pull-up torque
- n: Speed (actual value)
- n_N: Rated speed at the operating point
- n_S: Synchronous speed (n_S - n_N = slip speed s)

Synchronous speed:

$$n_s = \frac{f}{p}$$

Slip speed in %:

$$s = \frac{n_s - n}{n_s} \cdot 100\%$$

Delta circuit

400 / 690 V	Δ / Y	8.5 / 4.9 A
S1	4.0 kW	cos φ 0.82
1410 min ⁻¹		50 Hz
IP 54		Iso. KI F

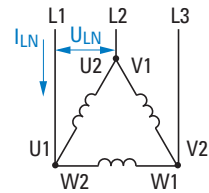

$$U_{LN} = U_W, I_{LN} = \frac{\sqrt{3}}{3} \times I_W$$

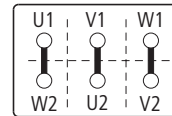

- With the specified 400/690 V voltage, this motor must be connected to the 3-phase system (U_{LN} = 400 V) in a delta circuit.
- Each motor winding is designed here for the maximum phase voltage of 400 V and can be connected directly.
- The three winding phases (U1 – W2, V1 – U2, W1 – V2) are combined in the terminal box and connected directly to the individual phases.

3-phase asynchronous motor speed:

$$n = \frac{f}{p} \cdot (1 - s)$$

- f: Frequency of voltage in Hz (= s⁻¹)
- n: Speed in r.p.m.
- p: Number of pole pairs
- s: Slip speed in r.p.m.

Electric power:

$$P_1 = U \times I \times \sqrt{3} \times \cos \phi$$

- P₁: Electrical power in W
- U: Rated operating voltage in V
- I: Rated operational current in A
- cos φ: Power factor

Motor output (power equation):

$$P_2 = \frac{M_N \times n}{9550}$$

- P₂: Mechanical shaft output power in kW
- M_N: Rated torque in Nm
- n: Speed in r.p.m.

Efficiency:

$$\eta = \frac{P_2}{P_1}$$



Planning safety and process optimization – CAD data at the click of a mouse!

ePLAN[®]

- 9,500 article data items and macros
- Convenient selection tool
- Version P8

Eaton is providing its customers with CAD data to offer optimum support during planning. Both electrical and mechanical design data can be called up quickly and conveniently from the Internet at any time. This reduces processing times, minimizes errors and thus reduces costs already in the engineering phase of control panels, systems and machinery.



- Models for approx. 10,000 products
- 70 different neutral & native formats

eCAD: Eaton makes product data and macros available for the EPLAN planning system and the Electric P8 version. Device data for over 9,500 products can be downloaded from the Eaton website and integrated in customer article databases using a specially developed selector.

mCAD: Eaton makes 2D and 3D data available for more than 10,000 products. Over 70 different neutral and native formats guarantee compatibility with the project engineering systems of the customer. The models can either be integrated directly into the planning software from the Partcommunity Portal on the Internet or via the CADENAS Partsolution software.

URL
www.moeller.net/cad



Worldwide export of machines and plants

European machine and system building and worldwide exports are closely related. Even if you don't export your machines at present, you should be prepared for it in the future. Eaton provides switchgear and protective devices with all the essential approvals and certificates for machine and system building. In most countries around the world, conformity with international standards is the sole requirement for successful exports. This is because components in these locations are governed by compliance with well known and established IEC standards. In this respect, the European CE mark is not only the passport for exports within Europe but also far beyond its borders.



World market equipment for machine building

Nearly all the switchgear and protective devices of Eaton's Moeller® series are world market devices. Each product line thus carries all the approvals and certification marks required for worldwide use.

These product lines include those for

- Pilot devices, limit switches
- Contactors and various timing and special relays
- Motor-protective circuit-breakers and relays
- Electronic components and systems.

With circuit-breakers and switch-disconnectors, Eaton offers IEC devices for use in most countries in the world and NA devices with virtually the same dimensions and the same accessories for the North American market. This considerably simplifies device selection since the North American standards often involve the need for considerably different technical specifications.

Electrical engineering products and their applications are not harmonized internationally.



The greatest differences to the IEC world are in North America, i.e. the USA and Canada. For many newcomers to the export business, it is initially surprising to experience the very different approaches and solutions.

Special components, such as handles for main switches that can only be operated by the intentional switching of an

additional handle when the control panel door is opened, may sometimes be required for export to North America. Likewise, the European motor-protective circuit-breaker is only accepted with an upstream protective device or with larger air and creepage distances at the incoming terminals. Eaton is the competent partner of choice for export-related issues here.

Qualified information is a critical key to success

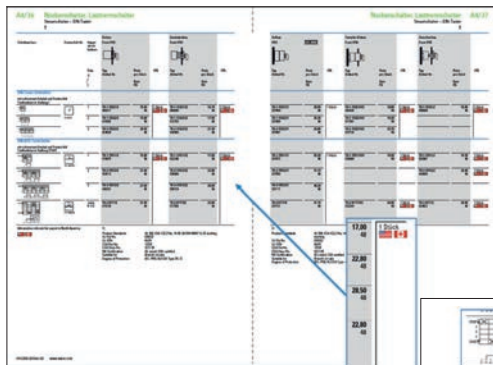

The Eaton Main Catalogue for Moeller® series products provides reliable information for machine and panel builders on the approval of components deployed for North American market. Each selection page provides information such as the relevant product standard, the E-File Number, the Category Control Number or the CSA Class Number. Many customers incorporate this information in their parts lists in order to be well prepared for the acceptance procedures.

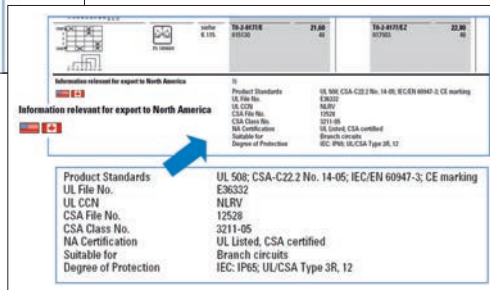

Up to 13 data items are listed here for each product, such as the suitability for use in feeders or branch circuits, the maximum operating voltage, or the North American degree of protection, such as UL / CSA Type 4X. The Main Catalogue also contains a glossary with explanations of the American terms.



The link <http://applications.eaton.eu> shows the relevant approvals or permits for each component type. This therefore enables you to view the certificates provided or, depending on the test authority, also the product report. The information given is the same as what is provided in the databases of the authorities.



Anyone wishing to avoid unfortunate experiences, should make use beforehand of the large number of publications that Eaton is offering on the issue of exports to North America. They contain the implementation of the codes & standards and a description of different practices.

These technical articles can be accessed via <http://www.eaton.eu/Europe/OurCompany/News/Publications/index.htm> They can be downloaded free of charge.



To find the right contact person:

At Eaton, we believe that building and maintaining strong relationships with our customers is something that deserves our undivided attention.

This is why you can rest assured knowing that you will be able to count on us for every project from the very start. To find out whom to contact for your needs, please visit our website:

In just a few steps, we will get you the contact information for the person or team in charge of support for your specific industry in your region.

To find the right contact person anywhere in the world, visit:

→ www.eaton.eu/contact

Support and Service for UPS Systems and Hydraulic System Solutions

Building a strong relationship with you is of utmost importance to us. This is why you can count on us to quickly get your questions, requests, and suggestions to the relevant specialists. After all, your challenges are our challenges.

Questions regarding uninterrupted power supplies (UPS)?

Our **Technical Service** staff will be more than glad to assist you if you are experiencing any difficulties with an Eaton UPS, DC power supply system, or any other Power Quality product.

Our **Technical Support** staff is there to answer any questions you may have regarding our products.

To find the right contact person anywhere in the world, please visit

www.eaton.eu/contact

Questions regarding hydraulic system solutions?

Simply contact our customer service head office in Baden-Baden and our staff will be glad to put you in contact with a local contact person.

Customer Service:

Eaton Hydraulics Group
Dr.-Reckeweg-Straße 1
D-76532 Baden-Baden
Germany

Phone: +49 (0)7221 682 - 0

Fax: +49 (0)7221 682 - 788

E-mail: customersupportemea@eaton.com



Eatons After Sales Service

Eaton is known for its unparalleled after-sales support for all low-voltage switchgear, switchgear systems, and services. For more detailed information, as well as to view our terms and conditions, please visit www.eaton.eu/aftersales

Europe, Middle East, Africa24/7

Hotline

For immediate support please call +49 (0) 180 5 223822* (24/7). You will receive competent and fast, round the clock assistance, with unplanned machine and system stand stills, system malfunctions and device failures.

(* 0,14 Euro per minute from the Deutsche Telekom network AG)

Helpdesk

Eaton specialists: +49 (0) 228 602 3640 (Monday–Friday from 08:00–16:00 CET) or contact your local Eaton representative.

We offer extensive support from commissioning to application queries as well as in the area of fault analysis, which can also include remote diagnostics.

We can also offer you an individual consulting service contract which is tailor-made to suit your requirements. If you would like to communicate your service queries in writing, please use the following e-mail address:

AfterSalesEGBonn@eaton.com

MGE OFFICE PROTECTION SYSTEMS
 MCGRAW-EDISON MOELLER
 METALUX MEM CUTLER-HAMMER
 COOPER HALO ARROW HART
 B-LINE BUSSMANN MTL
 HOLEC MCGRAW-EDISON
 ARROW HART MEM BUSSMANN
 METALUX POWERWARE
 MEM HALO BUSSMANN
 MCGRAW-EDISON CEAG
 MOELLER MTL POWERWARE
 CEAG COOPER BUSSMANN
 MTL B-LINE
 HERNIS
 MCGRAW-EDISON
 B-LINE
 ARROW HART
 MOELLER
 HALO MEM
 MTL
 COOPER
 HERNIS POWERWARE HOLEC
 BUSSMANN MTL ARROW HART
 B-LINE COOPER MCGRAW-EDISON
 MOELLER CEAG HOLEC MOELLER
 MTL POWERWARE CEAG
 MEM MGE OFFICE PROTECTION SYSTEMS
 HERNIS POWERWARE
 COOPER HALO CROUSE-HINDS

MORE POSSIBILITIES.
 POWERFUL SOLUTIONS.

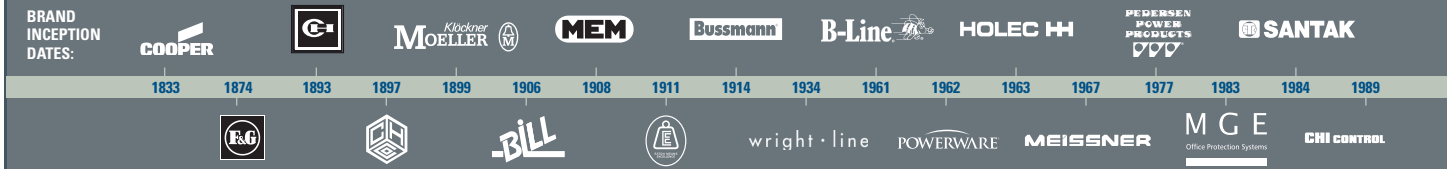

Powering Business Worldwide

Eaton has been serving the power management needs of our customers for more than a century. Over the years, we have expanded our expertise and portfolio of products and services by uniting some of the world's most respected names with Eaton's strong heritage of innovation.

Our goal is simple; to provide unique solutions across a wide range of markets that keep businesses on the leading edge of change. That's the power of One Eaton.

Eaton is dedicated to ensuring that reliable, efficient and safe power is available when it's needed most. With unparalleled knowledge of electrical power management across industries, experts at Eaton deliver customized, integrated solutions to solve our customers' most critical challenges.

Our focus is on delivering the right solution for the application. But, decision makers demand more than just innovative products. They turn to Eaton for an unwavering commitment to personal support that makes customer success a top priority. For more information, **visit www.eaton.eu**.

To contact an Eaton salesperson or local distributor/agent, please visit www.eaton.eu/electrical/customersupport

Changes to the products, to the information contained in this document, and to prices are reserved; so are errors and omissions. Only order confirmations and technical documentation by Eaton is binding. Photos and pictures also do not warrant a specific layout or functionality. Their use in whatever form is subject to prior approval by Eaton. The same applies to Trademarks (especially Eaton, Moeller, Cutler-Hammer). The Terms and Conditions of Eaton apply, as referenced on Eaton internet pages and Eaton order confirmations.

Eaton Industries GmbH

Hein-Moeller-Str. 7-11
D-53115 Bonn/Germany

© 2014 by Eaton Corporation
All rights reserved
Printed in Germany
Publication No.: CA04020001Z-EN-INT
Doku/DHW/ip/MP 11/16
Article No.: 170504



Eaton is a registered trademark of Eaton Corporation

All other trademarks are property of their respective owners.

SmartWire-DT® is a registered trademark of Eaton Corporation.