

# SIMATIC S5-135U, S5-155U/H

## General

### S5-135U, S5-155U

#### Application General

4



Fig. 4/1 S5-155U programmable controller

The SIMATIC S5-135U and S5-155U programmable controllers are multiprocessor controllers intended for automation tasks in the medium and upper performance levels. They provide a simple and economical solution for all automation tasks such as

- Open-loop control
- Closed-loop control and computation
- Communication
- Operator control and process monitoring
- Signalling and logging
- Data processing

The controllers are therefore suitable for:

- Machine control systems
- Process automation
- Process monitoring
- Coordinating functions

The standardized hardware technology, modular design of the PLCs and high performance capabilities of the programming device result in the following features:

- Easy use thanks to simple assembly of the modules and connection to I/O modules
- Simple adaptability of the various process signals because of different input/output voltages of the I/O modules
- Analog process signals can also be adapted via I/O modules
- Extra-discrete modular assembly using different I/O modules
- Simple programming by structuring the program and using standardized program sections (function blocks)
- Off-loading of the central processors and user program through the use of intelligent I/O modules (e.g. digital position decoder, valve control module)

- Simple communication with other programmable controllers and computers by means of internal communications processors and bus systems
- Easy system start-up by means of programming devices and service units with extensive programming and debugging aids

The programming language used is STEP 5 with the following methods of representation:

- Control system flowchart - CSF
- Ladder diagram - LAD
- Statement list - STL and at a higher level
- GRAPH 5/II for sequential control.

#### S5-135U programmable controller

The S5-135U is a multi-processor programmable controller with special-purpose central processors (CPUs) which are available in various combinations, each with its own program memory:

- CPU 928B, optimized for fast bit and word processing as well as serial point-to-point communication
- CPU 928, optimized for open- and closed-loop control tasks

- CPU 922, optimized for arithmetic operations, closed-loop control, monitoring and reporting

Each CPU uses the same operations set and is optimized for its particular tasks.

By using a number of CPUs, the automation task can be broken down into manageable parts. Each processor executes its program indepen-

dently of the others. This increases the overall processing speed. Each processor can be started independently of the others.

**S5-135U, S5-155U** (continued)**Application**  
(continued)**S5-155U programmable controller**

Apart from the CPUs mentioned, the following CPU can be used in the S5-155U programmable controller:

- CPU 948, optimized for high-speed execution of bit and word operations, with large capacity program memory

The S5-155U programmable controller is therefore the most powerful PLC in the SIMATIC S5 system.

The S5-155U programmable controller

- has a high processing speed and
- offers the largest memory expansion.

**S5-155H fault-tolerant programmable controller**

The fault-tolerant variant SIMATIC S5-155H is for automation tasks that must not be interrupted under any circumstances.

In order to ensure that the fault-tolerant S5-155H programmable controller is available in every case it is designed redundantly.

The S5-155H consists of 2 ZG 135U/155U central controllers (same hardware and software).

Both central controllers work together in dynamic 1 out of 2 structure (hot-standby).

This enables high demands to be placed on failsafety and availability.

**Design**

It is essential to have a CPU in the central controller. The CPU handles central control of the entire programmable controller.

Depending on requirements, a central controller can be equipped with the following modules:

- CPU 948 (in the S5-155U only) for high-speed bit and word processing with large memory
- CPU 928B, optimized for fast bit and word processing and serial point-to-point connection

- CPU 928, optimized for open-loop and closed-loop control tasks
- CPU 922, primarily for calculation, closed-loop control, monitoring and reporting
- Coordinator, required where more than one CPU is in use
- External memory: CP 516 memory submodule
- Communications processors for connecting human-machine interfaces and peripheral devices as well as for connection to local area networks

- Modules for the input and output of binary and analog signals
- CP 581 integrated PC
- Intelligent I/O modules
- Interface modules for connecting expansion units and distributed I/Os and field devices

**Expansion units**

If there are not enough slots available in the central controller, or if certain modules are to be deliberately located elsewhere, expansion units can be connected to the central controller. Centralized expansion units are located directly at the central controller or in a cabinet next to it. Distributed expansion units can be located up to 3000 m (9840 ft) from the central controller. Additional centralized expansion units can be connected to the distributed expansion units.

An expansion unit can be equipped with the following modules depending on design and requirements:

- Communications processors for connecting human-machine-interfaces, personal computers (PCs) and peripheral devices as well as for connection to local area networks

- Modules for the input and output of binary and analog signals
- CP 581 integrated PC
- Intelligent I/O modules
- Interface modules for connection to the central controller or additional expansion units

## SIMATIC S5-135U, S5-155U/H

## General

## S5-135U, S5-155U (continued)

Design (continued)  
Multiprocessing

The performance capability of a programmable controller can be considerably enhanced by using several CPUs. Each CPU executes its program independently of the others.

A coordinator assigns access to the internal S5 bus to the CPUs. The necessary information exchange between the CPUs is also handled by the coordinator.

Each CPU can be started up independently of the others.

## Internal S5 bus

The internal S5 bus connects the modules of the programmable controller with each other. All internal data traffic between the CPUs,

memory submodules, communications processors, interfaces and input/output modules is conducted over this bus.

If several CPUs are in use, a coordinator controls access to the internal S5 bus.

## Interface modules

In centralized and distributed configurations, interface modules handle data traffic between the central controller and the expansion units as well as distributed I/Os completely autonomously. This means that modules in

the expansion units behave in exactly the same way for the user as modules in the central controller.

The PROFIBUS-DP field bus can be designed with a special interface module.

A feature of this LAN is fast cyclical communication and enables simple connection of distributed I/O stations and field devices to the automation system.

## Communications processors

Communications processors handle data traffic with the following completely autonomously:

- Standard peripheral devices such as printers, keyboards, CRT units
- Computers
- Other programmable controllers

This offloads the CPU of time-intensive communications tasks.

The necessary data for texts and images can be stored in each communications processor's own RAM or EPROM submodule.

In addition, communications processors can be used to configure the SINEC L1, PROFIBUS and Industrial Ethernet LANs and to connect programmable controllers to the LAN.

## Input/output modules and intelligent I/O modules

The input/output modules and the intelligent I/O modules constitute the link between the programmable controller and the process. They can be plugged into the central controller and the expansion units.

**S5-135U, S5-155U** (continued)**Design** (continued)  
Possible configurations**Central configuration**

In a central configuration, the expansion units are either in the same cabinets as the central controllers or in a separate cabinet next to it. The maximum length for the cable connecting the central controller to the furthest expansion unit is 2 m (6.5 ft).

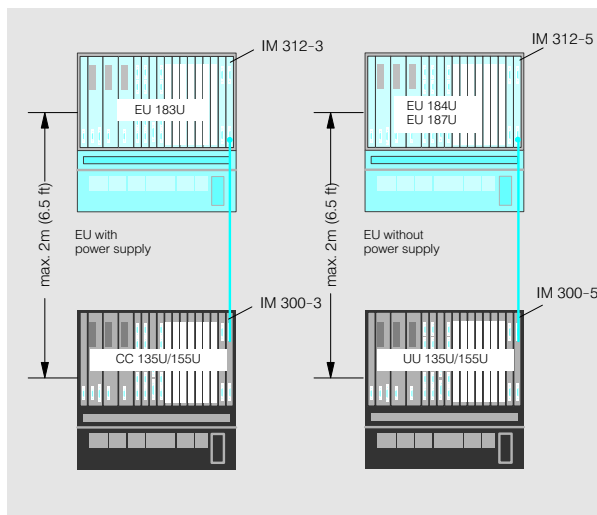

Fig. 4/2 Central configuration of expansion units

**Distributed configuration**

In a distributed configuration, the expansion units are installed at a distance of up to 3000 m (9840 ft) from the central controller. Four additional expansion units can be connected in a distributed configuration to each distributed expansion unit.

Expansion units of the S5-115U and the distributed I/O and field devices can also be connected.

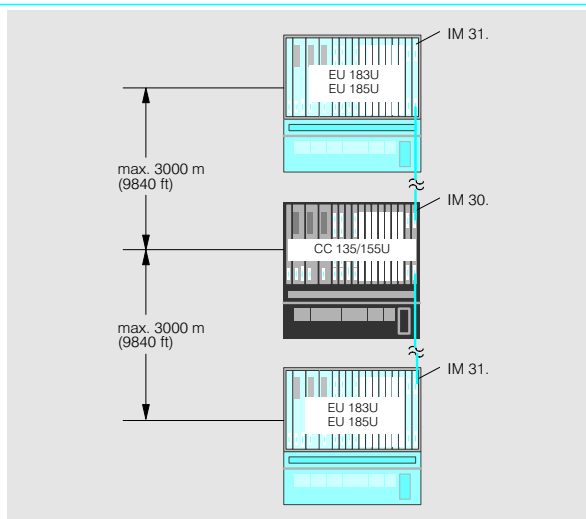

Fig. 4/3 Distributed configuration of expansion units

## SIMATIC S5-135U, S5-155U/H

## General

## S5-135U, S5-155U (continued)

Design (continued)  
Mechanical features

4

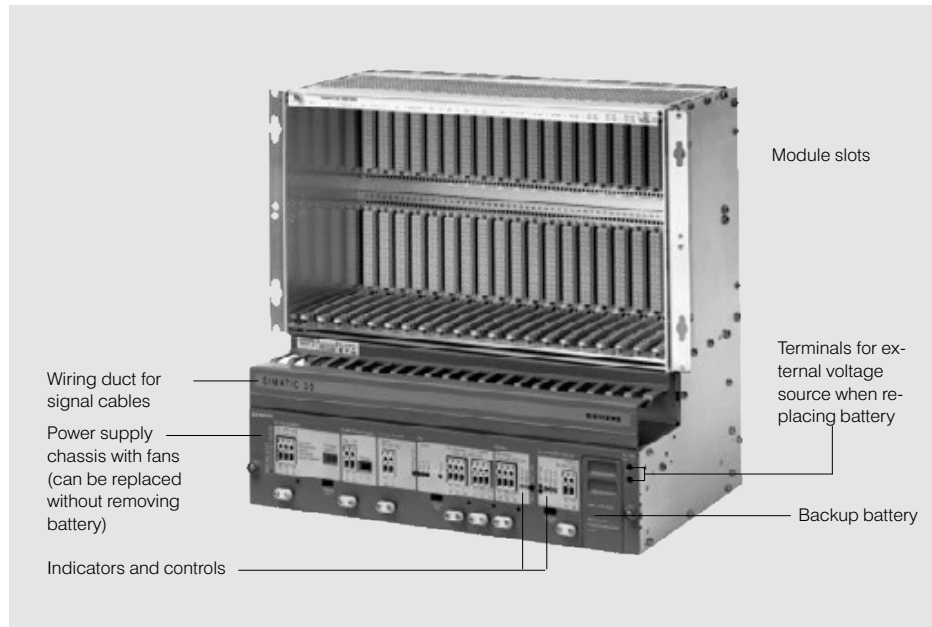

Fig. 4/4 Mechanical features of the ZG 135U/155U central controller for the S5-135U and S5-155U programmable controllers

The central controllers and expansion units consist of a compact housing with

- Power supply chassis with 3 fans and a lithium backup battery as well as a storage battery (for the RAM)
- 21 (or 20 or 11) module slots

The backup battery is not required in expansion units. Expansion units are also available without the power supply chassis or fans.

#### Housing

The housing consists of bolted sheet-steel sections with ventilation openings at the top and bottom. The slots have socket connectors and guides to accommodate the modules.

A wiring duct for signal cables runs along the front, beneath the modules and above the power supply chassis.

#### Power supply chassis

The power supply chassis with 3 fans is located in a tier in the bottom part of the housing.

The input voltage is either 24 V DC or 230/120 V AC. An internal switch is provided for selecting either 230 V or 120 V AC.

Output voltages for the internal power supply to the modules:

5 V DC (10 A, 18 A, 40 A; short-circuit protected), with jacks for measuring current, 24 V DC (0.4 A, 0.5 A, 1 A, 2 A; fused), with jacks for measuring voltage 15 V DC

Monitoring facilities (with LED indicators) are provided for:

- Input voltage (no indication)
- 5 V output voltage
- 15 V, 24 V output voltage
- 3.4 V backup battery voltage
- Airflow for the fans
- 24 V load voltage (external)

All screw terminals on the power supply chassis are intended for conductors of up to 4 mm<sup>2</sup> cross-section.

#### Backup battery

A lithium backup battery with storage battery as reserve is provided to supply power to all RAMs in the event of a power failure.

Two jacks are provided for external input of the backup voltage. This allows the backup battery to be replaced without interrupting the backup voltage, even when the input voltage is switched off. The power supply chassis can be replaced without interrupting the backup supply.

**S5-135U, S5-155U** (continued)**Design** (continued)  
**Mechanical features**  
(continued)**Design and connection of the I/O modules**

The input and output modules have a plastic cover to protect the components and printed circuits from accidental contact. The module widths correspond to either 1 or 2 slots.

LEDs to the left of the terminal pins - corresponding to the labelling area of the front connectors - indicate the statuses of inputs and outputs.

A DIL coding switch is used to set the parameter range (address range) for addressing a module.

A swivelling handle facilitates module extraction.

Front connectors (of single and double width) are available for connecting signal leads to the module. The front connectors latch onto the module at the bottom and are screwed to the module at the top.

Attaching front connectors for AC to DC modules is prevented by mechanical keying as a safeguard against dangerous operating conditions. The front connectors can be labelled on their sides.

Special self-adhesive labelling strips are provided with each module. These should be affixed to the front connector. This clearly identifies the individual inputs and outputs.

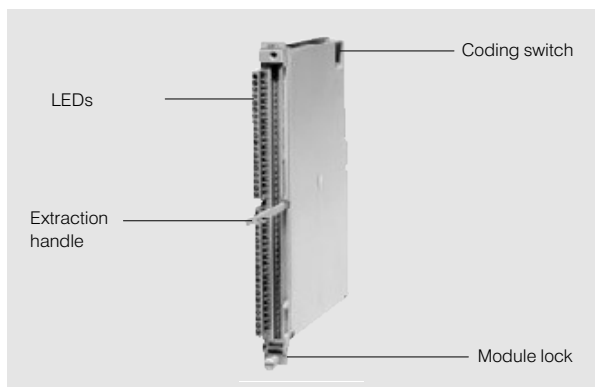

Fig. 4/5 Design of the I/O modules

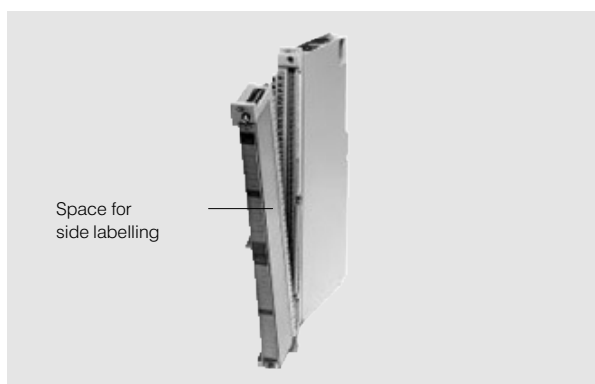

Fig. 4/6 Connection via front connectors

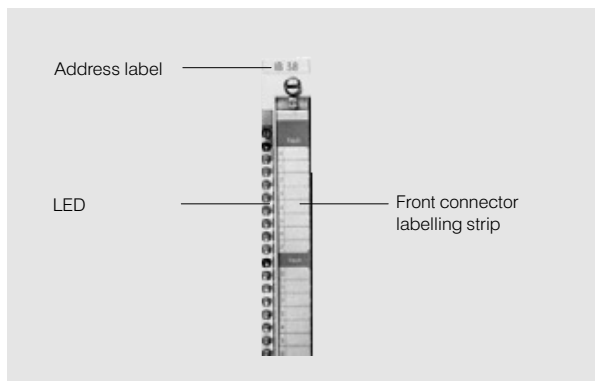

Fig. 4/7 I/O modules with labelling strips

## SIMATIC S5-135U, S5-155U/H

## General

## S5-135U, S5-155U (continued)

Design (continued)  
Mechanical features  
(continued)Desing and connection of  
the I/O modules  
(continued)

Signal leads are connected to the modules using the front connectors.

There are two ways of connecting signal leads to the front connectors:

- Crimp snap-in terminals for single and double-width front connectors
- Screw terminals for single and double-width front connectors; end sleeves for the conductors are not required.

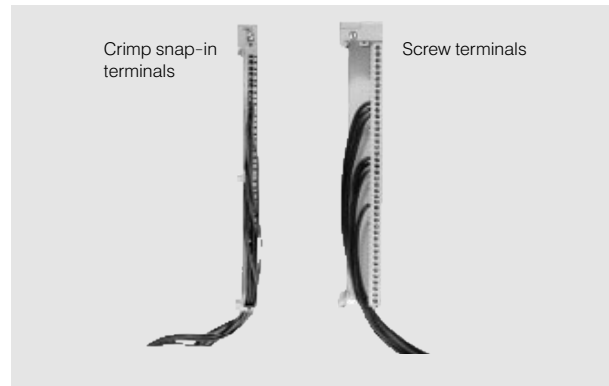

Fig. 4/8 Connection of the signal cable

4

## Principle of operation

The principle of operation of the S5-135U and S5-155U programmable controllers is largely governed by the components "program memory" and "processor".

In the S5-155H fault-tolerant programmable controller, the redundancy functions are an additional factor (see page 4/18).

**Program memory**

The program contains the user program.

**Processor**

The processor operates cyclically:

At the beginning of the cycle, the processor reads the signal states of all inputs and stores them in a process input image (PII).

The program is then executed step by step.

The processor stores the calculated signal states in a process output image (POI).

At the end of the cycle, the processor writes the signal states into the outputs.

The cycle can be stopped by interrupts (process and time interrupts).

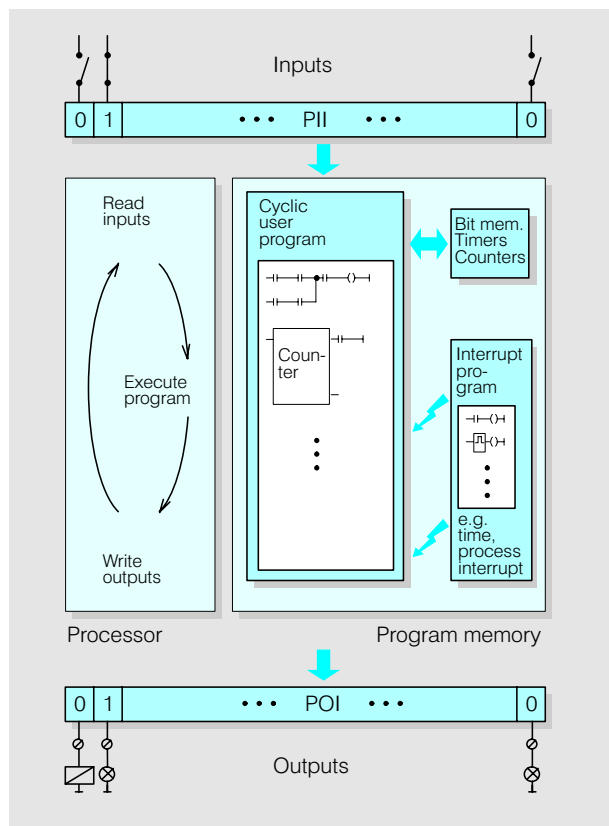

Fig. 4/9 Functional design of the S5-135U, S5-155U

## S5-135U, S5-155U (continued)

Programming  
Programming language

Fig. 4/10 Programming the S5-135U and S5-155U/H programmable controllers

The programming language for SIMATIC S5 programmable controllers is STEP 5 (see Section 7) in one of the following representations:

- CSF - Control System Flowchart
- LAD - Ladder Diagram
- STL - Statement List

Programs for sequence control systems can be entered clearly in the form of a flow diagram using GRAPH 5 (see Section 7).

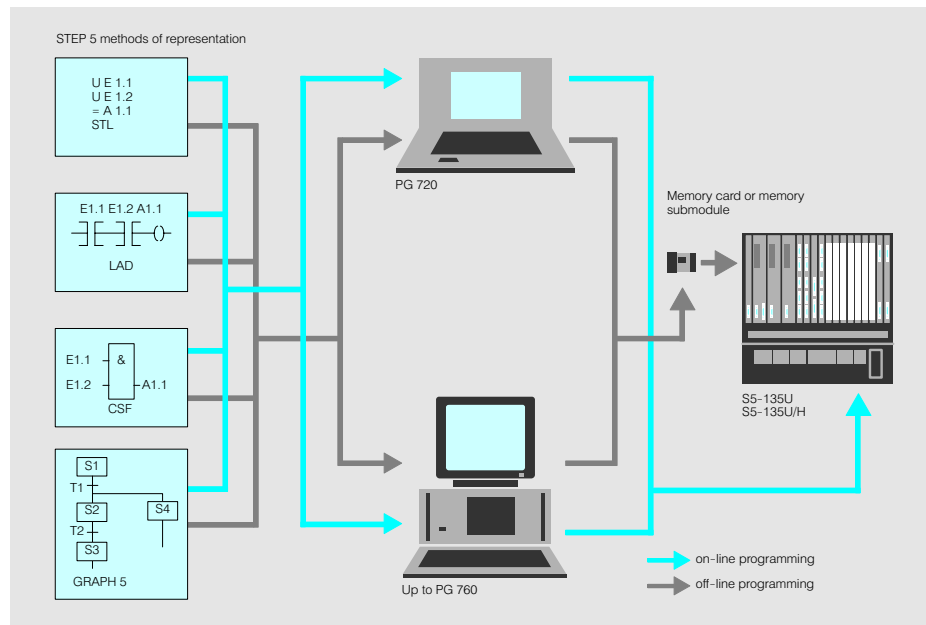
## Programming devices

The following programming devices can be used for programming the S5-135U and the S5-155U/H programmable controllers:

- PG 720, PG 720P
- PG 740

- PG 760
- PG 710 Plus, PG 730, PG 750, PG 770

The programming devices have operator prompting to facilitate programming and aids for debugging and system start-up.

A printer can be connected to the programming device for program documenting.

## Program input

There are two ways of entering the program:

- Direct program entry to the CPU in the central controller (on-line programming)

- Programming the memory cards or memory submodules (EPROM or EEPROM) in the programming device without connecting it to the PLC.

The memory card or memory submodule is then plugged into the central controller (off-line programming).

## Program execution

## Cyclic program execution

The blocks of the user program are executed in the sequence specified in the organization block.

## Interrupt-driven program execution

When certain input signal changes occur, cyclic execution is interrupted at the next statement and an organization block assigned to this

event is started. The user can formulate his response program to this interrupt in this organization block. Cyclic program execution is then resumed at the point at which it was interrupted.

## Time-controlled program execution

An organization block is called after a preset time (time interrupt). Organization

blocks are available. Times between 10 ms and 20 min can be set for each organization block. This makes it possible for certain parts of the program to be processed independently of the scan time.



# SIMATIC S5-135U, S5-155U/H

## General

### S5-135U, S5-155U (continued)

#### Communication Point-to-point connection

Communications processors enable the programmable controller to communicate with other programmable controllers, computers, human-machine-interfaces, and peripheral devices through point-to-point connections.

They have their own memory for data, texts and graphics. Data communication with the devices connected is handled by the communications processors absolutely independently, which relieves the central processing units from time-consuming communications tasks.

Communication with computers, other programmable controllers and peripheral devices, such as printers, is carried out by the CP 523, CP 524 and CP 544 communications processors.

The CP 526, CP 527 and CP 528 communications processors are responsible for communications with the units of the SIMATIC HMI human-machine-interface.

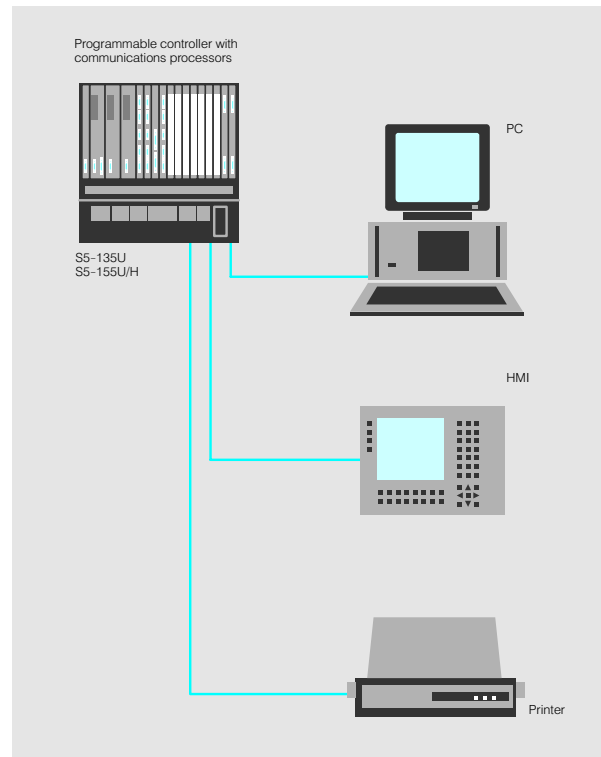

Fig. 4/11 Interfacing the programmable controller with PC, HMI devices and printer

#### Local area networks

##### SINEC L1 bus system

The SINEC L1 bus system (Siemens Network Communication Low Range) provides a simple solution to the configuring of small, distributed automation systems on the lower level of communications technology.

The following PLCs can be connected to this bus system: S5-90U, S5-95U/F, S5-100U, S5-115U/H/F, S5-135U and S5-155U/H.

##### Features

- Up to 31 nodes
- Baud rate 9.6 kbit/s
- Max. coverage 50 km (31 miles)
- Transmission medium: twisted pair cable

##### PROFIBUS bus system

See Section 10.

##### Industrial Ethernet bus system

See Section 10.

**S5-135U, S5-155U (continued)****Quality assurance procedures**

To ensure correct operation of all SIMATIC S5 products and to prevent failures, extensive, cost-effective quality assurance procedures are carried out at every stage of the life of a product:

- During product planning
- During product development
- During production
- In product operation

**Product planning**

The product planning phase covers all the activities from market research to type specification. Quality assurance in the product planning phase ensures that the SIMATIC S5 product conforms to the high standards of quality required on the market.

**Product development and production**

The following are some examples of routine quality assurance precautions taken during development and production:

- Use of high-quality components

- Worst-case design of all circuits
- Systematic and computer-controlled testing of all components supplied by subcontractors
- Burn-in of all LSI circuits, e.g. processors and memories. Burning in is an aging process which helps to reduce the number of failures early in a product's life. The components are subjected to a high temperature for several hours in a burn-in cubicle
- Measures to prevent static charge building up when handling MOS circuits
- Visual inspections at various stages of production
- In-circuit testing of all modules, i.e. computer-aided testing of all components and their interaction with other components in the complete circuit
- Continuous heat-run test at elevated ambient temperature over a period of several days

- Careful computer-controlled final testing
- Statistical evaluation of all failures to enable the immediate initiation of suitable corrective measures

**Product operation**

Even when the SIMATIC S5 products are in operation on the customer's premises, they are still under constant supervision. Extensive quality control precautions are taken in the following areas:

- Stockkeeping and dispatch
- Service
- Field observation

Established methods are used in all these areas, which operate precisely, punctually and conscientiously, whilst also remaining flexible for special customer requirements.

Sometimes an even higher level of fault-tolerance or safety is required than that normally offered by the SIMATIC S5 U range. Fault-tolerant or failsafe programmable controllers, such as the S5-115H or the S5-115F are available for this purpose.

4

**Availability**

Availability is the probability of finding a system in a func-

tional state at a specified point in time.

**Safety**

Safety is defined by DIN 31000 as "A state of lower risk than the permitted limit". The "permitted limit is the maximum acceptable

degree of risk for a specific plant". The plant-specific degree of risk may be stipulated by law, by the plant

operator or by an independent body of experts, e.g. the German Technical Inspectorate (TÜV).

**Installation guidelines**

SIMATIC programmable controllers are designed for use in harsh industrial environments. To ensure correct operation of the equipment, it must be installed and connected in accordance with certain rules. Certain principles must also be observed as regards wiring, earthing and shielding.

Timely planning of the necessary measures for improving the electromagnetic compatibility (EMC) of the programmable controllers is advisable in order to avoid retrofitting. These rules are explained in the section entitled "Installation guidelines" in the relevant product manuals.

For the installation of failsafe controls, the relevant regulations must be observed.

# SIMATIC S5-135U, S5-155U/H

## General

### S5-155H, S5-155H Lite

#### Application

# 4

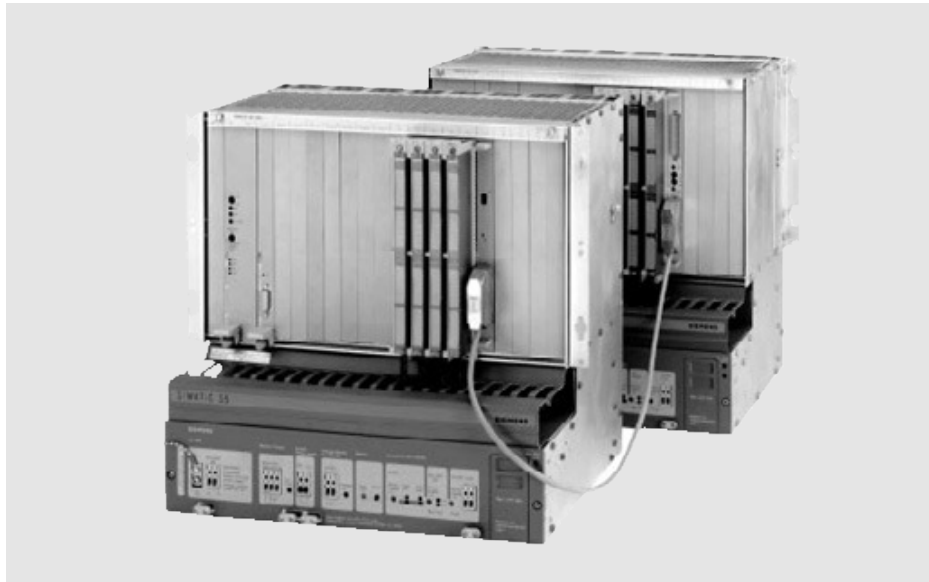

Fig. 4/12 S5-155H programmable controller

In many fields of automation, increasingly high demands are being placed on the availability and fault-tolerance of programmable controllers (PLCs). Particularly in fields where a plant shutdown would be extremely expensive. In such cases, only redundant systems can offer the standard of availability required. Fault-tolerant systems continue to work in all likelihood when one or more parts of the control fail.

The S5-155H/S5-155H Lite programmable controller consists of two interlinked central controllers. It operates on the "master/slave" principle. One subunit, the master, controls the process. If a fault occurs, the other subunit, the slave, takes over control.

This ensures a high degree of fault-tolerance, which makes the S5-155H/S5-155H Lite programmable controller especially suitable for applications in the following fields:

Fields with predominantly continuous processes, e.g.:

- Refineries
- Chemicals
- Power stations
- Steelworks
- Environmental protection (e.g. water treatment)
- Pipelines
- Off-shore installations

Areas of production employing batch processes, e.g.:

- The automotive industry
- The pharmaceutical industry
- The food industry
- In plants with flexible manufacturing systems
- In high-bay warehouses

## S5-155H, S5-155H Lite (continued)

## Design

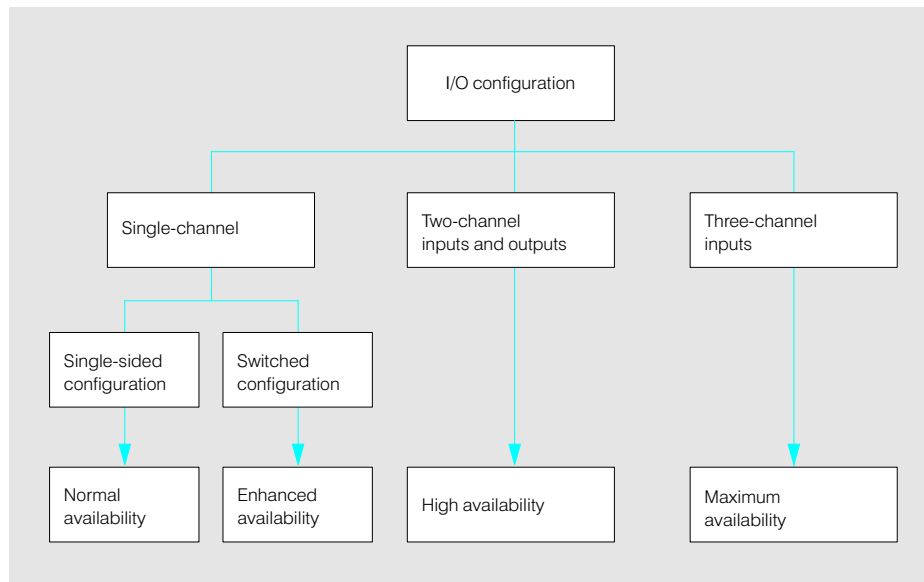

Fig. 4/13 Degrees of availability of the I/O area

In the S5-155H/S5-155H Lite programmable controller the central functions are always implemented in a redundant configuration.

**S5-155H**

Configured with CPU 948R

**S5-155H Lite**

Configured with CPU 948RL

The I/Os can, however, also be configured with redundancy.

The two subunits of the S5-155H/S5-155H Lite programmable controller are both equipped with the same hardware and software and interlinked via the IM 304 and IM 324R interface modules (for linking central controllers) and the 721 connecting cable.

Three different levels of availability are possible, depending on the arrangement of the I/O modules:

- Normal availability (single-sided configuration)
- Enhanced availability (switched configuration)
- Maximum availability (fully redundant configuration)

Full redundancy of the S5-155H/S5-155H Lite is implemented with

- Two-channel configuration of inputs and outputs
- Three-channel input configuration

Fig. 4/13 shows the configurations for the three levels of availability.

The different levels of availability can be combined as required.

The performance capability, user convenience and other technical features of the S5-115H/S5-155H Lite fault-tolerant programmable controller correspond to a large extent to the features of the S5-155U.

## SIMATIC S5-135U, S5-155U/H

## General

## S5-155H, S5-155H Lite (continued)

## Design

Normal availability  
(single-sided configuration)

In the single-sided configuration (see Fig. 4/14) the I/Os are connected in single-channel mode and only addressed by one of the two subunits. The I/Os in this configuration can be plugged into either

- a central controller or, if the number of slots is not sufficient,
- expansion units.

Information read into the one subunit (e.g. from digital input modules) is automatically transmitted to the second subunit.

It is immaterial whether one subunit is the master and the other the standby. What is important is whether or not the subunit which is connected to the I/Os is operational.

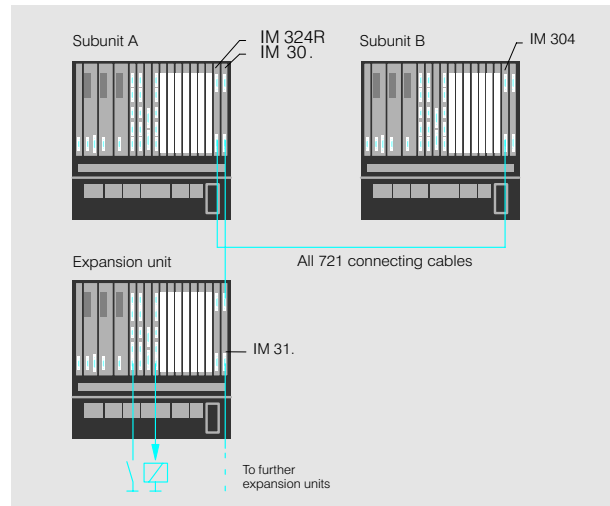

Fig. 4/14 Single-sided configuration (normal availability)

In the event of a failure, the I/Os connected to the subunit concerned are also out of action.

This configuration is used for sections of a plant which do not require enhanced availability.

Enhanced availability  
(switched configuration)

In the switched configuration (see Fig. 4/15) the I/Os are connected in single-channel mode, but they can be addressed by both subunits. The I/Os in this configuration must always be plugged into an EG 185U expansion unit. Up to 16 expansion units can be connected in switched configuration, distributed between up to 8 I/O bus lines.

Expansion units in switched configuration are connected via the IM 304 interface module in the central controller and the IM 314R interface module in the expansion unit. The expansion units can also be expanded in a centralized configuration via the IM 300 interface module.

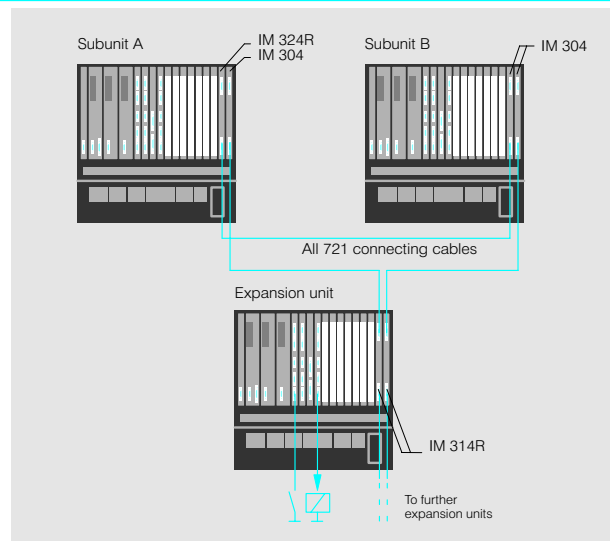

Fig. 4/15 Switched configuration (enhanced availability)

Expansion units in switched configuration are connected to both subunits and are addressed by the one currently acting as master.

This configuration is employed when failure of individual I/Os is not crucial.

**S5-155H, S5-155H Lite** (continued)**Design** (continued)  
High availability  
(fully redundant configuraion)**Two-channel configuration**

In the two-channel I/O configuration, identical I/Os are installed with the same addresses in both subunits. Both failure of one of the central controllers and failure of one of the two redundant I/Os can be tolerated. The I/O modules can be installed either in the central controllers themselves or in expansion units.

**Three-channel configuration**

The maximum degree of availability is obtained with a three-channel input configuration. Two of the three input channels are assigned to the CPUs directly, whereas the third channel is connected to both CPUs via an expansion unit in switched configuration. If one of the CPUs fails, the intact CPU continues to operate with two input channels.

The three-channel input configuration has the following advantages:

- A high degree of availability with a choice of two out of three
- Numerous faults can be recognized and located without additional wiring such as:
  - Module fault,
  - Load voltage failure,
  - Wirebreak,
  - Short-circuit to frame and
  - Sensor fault
- Low wiring overhead
- Both redundant and diverse sensor configurations possible

The redundant I/O modules to be used in the two- and three-channel configurations must be made known to the operating system using the COM 155H parameter assignment software.

They can be addressed in the same way as single-channel I/Os in the user program. The operating system does the rest.

The communications processors can also be used with two-channel mode in a redundant configuration (see page 4/16). The user must program the redundancy function.

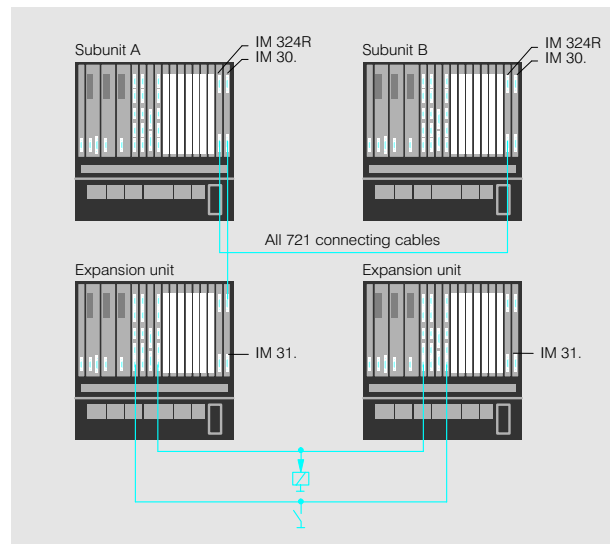

Fig. 4/16 Two-channel configuration (high availability)

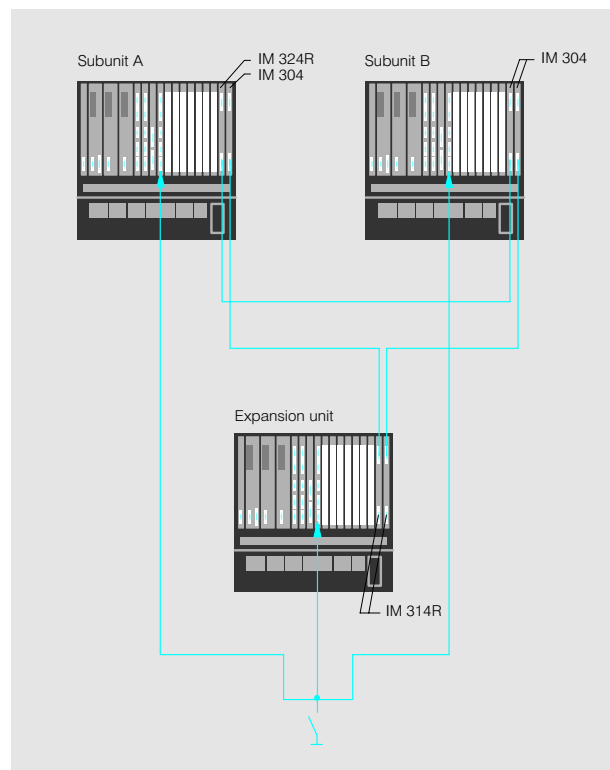

Fig. 4/17 Three-channel configuration (maximum availability)

The following can be connected to the central controller:

- EG 184U
- EG 185U
- EG 187U
- ET 100U electronic terminator
- ET 200 distributed I/O system

## SIMATIC S5-135U, S5-155U/H

## General

## S5-155H, S5-155H Lite (continued)

Design (continued)  
Mixed configuration

The different levels of availability can be combined as required. A mixed configuration, i.e. a combination of redundant, switched and single-sided configuration, is frequently the most economical solution.

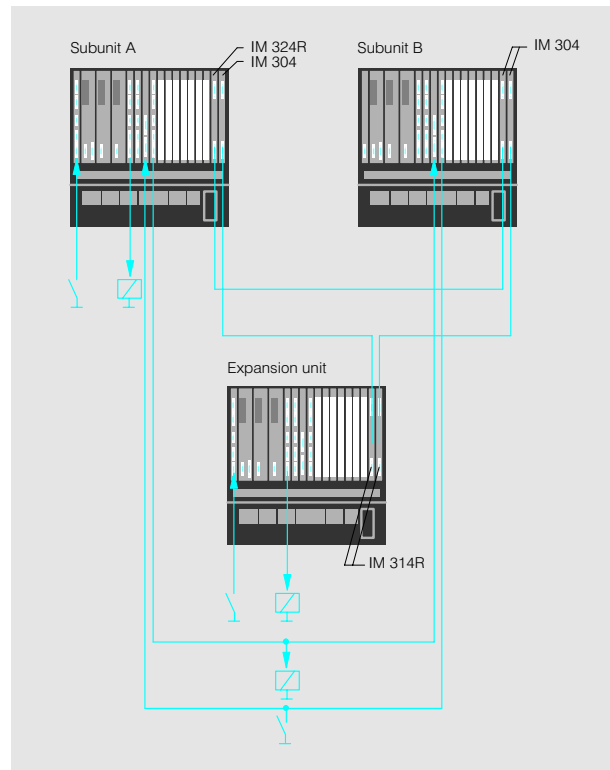

Fig. 4/18 Mixed configuration

4

Redundancy of the  
IPs and CPs

Intelligent I/O modules (IPs) and communications processors (CPs) can also have redundant configuration.

Switched redundant  
configuration

The IPs and CPs can be plugged into expansion units of switched configuration.

Two-channel redundant  
configuration

The CPs can additionally be plugged into the two subunits.

**Selection criteria**

The type of configuration which is most favorable depends on the type of application.

Advantages of the switched redundant configuration:

- In the case of a central controller failure, the IPs/CPs remain redundant
- In the case of an IP/CP failure, the central controllers remain highly fault tolerant
- Shorter scan time

Disadvantages of the switched redundant configuration:

- At least two switched expansion units required
- If the IPs/CPs are to be repaired, the corresponding expansion unit must be switched off. This means that all other I/O modules in this expansion unit are out of operation

Advantages of the two-channel redundant configuration:

- No switched expansion units required
- If the CPs are to be repaired, only redundant components have to be disconnected from the power supply

Disadvantages of the two-channel redundant configuration:

- Longer scan time

**S5-155H, S5-155H Lite** (continued)**Design** (continued)  
Redundancy of the  
IPs and CPs**IPs and CPs in switched  
redundant configuration**

If an intelligent I/O module (IP) or a communications processor (CP) is to be used in switched expansion units, a minimum of two expansion units is required. One CP/IP each must be plugged into the two expansion units. If data is received in an intelligent I/O module or a communications processor, it is automatically transmitted to the second subunit, regardless of which is the master and which is the reserve unit.

**CPs and IPs in two-channel  
redundant configuration**

If a communications processor (CP) or an intelligent I/O module (IP) is to be of two-channel redundant configuration, one CP/IP must be plugged into each of the two subunits. Both CPs/IPs are assigned different page frames and operate independent of each other. If a CP/IP receives data, it is automatically transmitted to the second subunit, regardless of which is the master and which is the reserve unit.

The redundancy function both in the case of the switched and the two-channel redundant configuration must be programmed by the user. The user program defines which CPs/IPs are active and it must detect whether one of the CPs/IPs is faulty, in order to be able to switch over to the other CP/IP if necessary.

The operating system ensures that the data in both subunits remains equal. Both CPs/IPs are regarded as independent modules.

In contrast to the I/O modules in redundant configuration, redundant CPs and IPs are assigned different addresses and page frames in the two subunits.

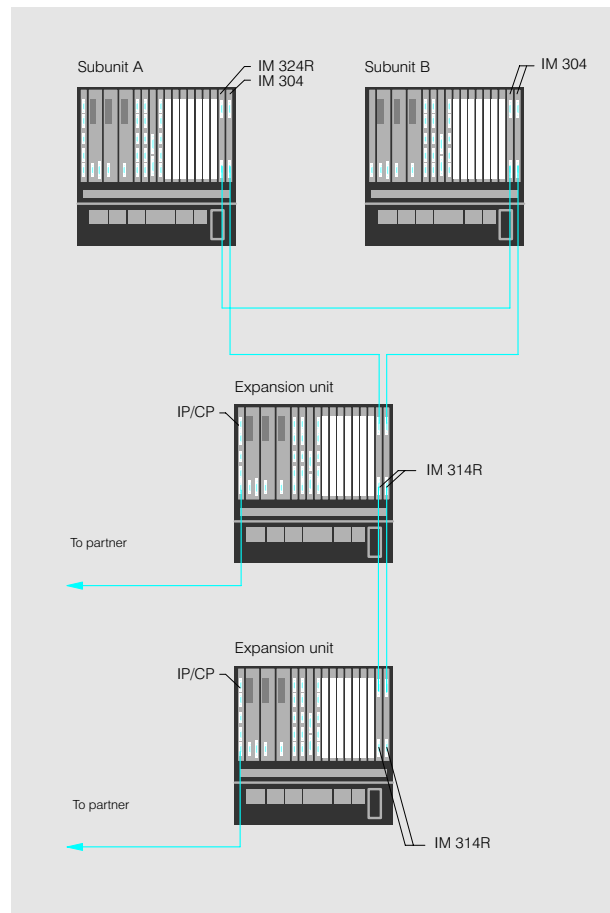

Fig. 4/19 CP/IP in switched redundant configuration

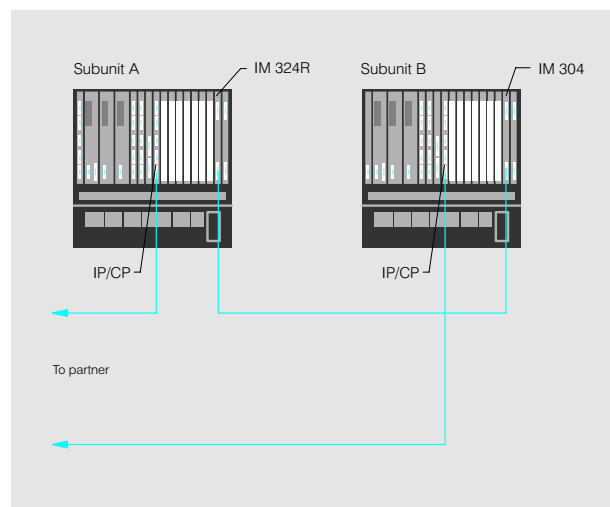

Fig. 4/20 CP/IP in two-channel redundant configuration



## SIMATIC S5-135U, S5-155U/H

## General

## S5-155H, S5-155H Lite (continued)

## Principle of operation

The principle of operation of the S5-155H/S5-155H Lite fault-tolerant programmable controller can be compared with an "OR" operation. The programmable controller is in an operational state when at least one of the two subunits is functioning correctly (see Fig. 4/21).

Both central controllers contain the CPU 948R/RL. The operating system of the CPU 948R/RL performs all the additional functions of the S5-155H/S5-155H Lite independently e.g.:

- Data exchange
- Fault handling (switchover to standby unit)
- Synchronization of the two subunits
- Self-test
- Fault locating

The operating system of the S5-155H/S5-155H Lite supports redundant operation of:

- Digital I/O modules
- Analog I/O modules

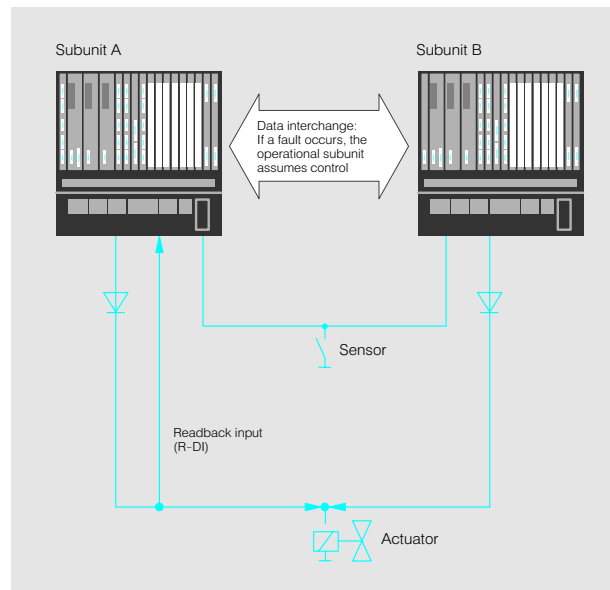

Fig. 4/21 Example of an S5-155H with redundant input and output

4

## Data interchange and fault handling

## Master-slave operation

The S5-155H/S5-155H Lite basically operates on the master-slave principle in hot-standby mode (see right). One subunit, the master, controls the process. If a fault occurs, the other subunit, the standby or slave, takes over the control functions. The faulty subunit can then be repaired without interrupting the process.

The combined operation of the two subunits differs according to the I/O configuration:

- Switched configuration  
The master controls the process whilst the slave merely runs on standby. If a fault occurs, the standby immediately takes over control

- Two-channel I/O configuration (fully redundant configuration)  
Both subunits control the process in parallel. The standby also issues output signals and reads in input signals. For further details, please refer to Section 11 (Configuring)
- Three-channel I/O configuration (fully redundant configuration)  
The combined operation of both subunits corresponds to the two-channel I/O configuration

## Hot-standby

Hot-standby is the ability to switch over to a standby device in the event of a fault automatically and without detrimental effect.

For operation in this mode it is absolutely essential that both subunits should be able to exchange data quickly and reliably. In the S5-155H/S5-155H Lite the two subunits are normally linked by the central controller interface via which they are both supplied with:

- The same user program
- The same data blocks
- The same process I/O image contents
- The same receive buffer contents, e.g. when using communications processors

The standby unit is therefore always up to date and ready to take over control immediately if a fault occurs.

**S5-155H, S5-155H Lite** (continued)**Principle of operation**  
(continued)  
Synchronization

To avoid delay in switching over from master to standby, synchronization of the subunits is essential. This includes interchange and comparison of data to ensure that both subunits have the same information at their disposal. The synchronization procedure used for the S5-155H/S5-155H Lite is "event-driven synchronization".

Event-driven synchronization is carried out every time an event occurs which could change the internal state of the subunits, e.g.:

- Commands with direct access to the I/Os
- Block call commands
- Time function commands

The user need not think about the synchronization when programming. The synchronization is completely taken over by the operating system.

## Self-test

Extensive self-test functions are implemented in the S5-155H/S5-155H Lite. The following components and functions are tested:

- Internal S5 bus
- Central controller link
- Fault locating device
- CPUs
- Processing unit/ASIC
- Memories

Every fault recognized by self-test is reported.

**Self-test on restart**

Each subunit runs through all the self-test functions on restart.

**Self-test in cyclic operation**

For cyclic operation the operating system breaks down the self-test functions into short sections approximately 5 ms long. One or more of these is processed in a cycle. The number of sections per cycle is configured by the user.

## Operating modes

**Fault detection**

In the two-channel redundant I/O configuration faults are detected by:

- Comparison, in the case of digital inputs
- A readback input, in the case of digital outputs
- Comparison, in the case of analog inputs
- Comparison and readback, in the case of analog outputs

In the three-channel redundant input configuration fault detection takes place with a choice of two out of three.

**Fault detection with fault locating**

For uninterrupted operation, the operating system must be able not only to detect faults but also to locate them, in order to deactivate the faulty module (by switching off the load voltage, in the case of outputs).

This operating mode can be used for both digital input and output modules. Advantages of this operating mode:

- In the event of a fault, the programmable controller S5-155H/S5-155H Lite continues to operate with the module which is functioning correctly
- Faults can be corrected more quickly and easily

In the two-channel redundant I/O configuration, the operating system is responsible for the software side of fault locating. On the hardware side, locating inputs and outputs (L-DIs and L-DOs) are required.

In the three-channel redundant input configuration, fault detection takes place by fault locating with a choice of two out of three.

For further information regarding the principle of operation of the fault-tolerant S5-155H/S5-155H Lite programmable controller, see Section 11 (Configuring).

## SIMATIC S5-135U, S5-155U/H

## General

## S5-155H, S5-155H Lite (continued)

Programming,  
parameter assignment  
Programming

Programming of the S5-155H/S5-155H Lite programmable controller is the same as for the S5-155U. All STEP 5 operations allowed in the S5-155U, apart from the multi-processing operations, can be used.

Both on-line and off-line programming are possible.

## On-line programming

For on-line programming the programming device is connected to the CPU of one of the subunits. The program is automatically relayed to the other subunit.

## Off-line programming

Off-line programming is possible using an EPROM submodule in the programming device without connecting it to the programmable controller. The submodule is then duplicated and plugged into the CPUs of both subunits.

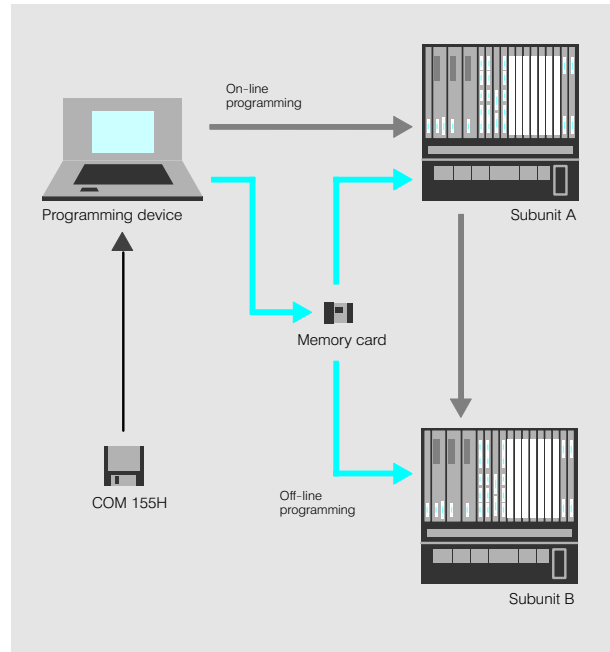

Fig. 4/22 On-line and off-line programming

4

## parameter assignment

## COM 155H parameter assignment software

The COM 155H parameterization software supports the user in parameter assignment and error diagnostics:

- Interactive parameter assignment of data specific to the H version
- Generation of the parameter assignment data block from the parameter assignment data
- System diagnostics using the error data blocks and the interrupt register
- Printout of data specific to the H version
- General system handling, e.g. starting the system

# SIMATIC S5-135U, S5-155U/H

## Central processing units

### CPU 928A

#### Application



The CPU 928A is designed for mid-range applications. It is particularly suitable for high-speed word processing (arithmetic operations, closed-loop control) and for high-speed binary signal processing (logic control). It can be used in S5-135U and S5-155U.

4

#### Design

The module contains the following:

- Microprocessor (ASIC) for processing binary statements and for high-speed processing of a number of selected word statements
- Microprocessor (16 bit) for processing word statements and the operating program of the module
- Microprocessor (8 bit) for processing the programming device port
- Memory (RAM) for bit memories, timers, counters, process image, etc.
- Internal memory: 64 Kbyte for the user program and 46 Kbyte (RAM) for data of the user program (data blocks)
- Receptacle for SIMATIC memory card (FLASH EPROM) for max. 64 Kbyte user program. STEP 5 V6.6 and higher is required for programming and erasing the memory card.
- Programming device port (15-way Cannon socket)
- Shift register (246 x 8 bit) with high processing speed
- Operating program for cyclic, time- and process-controlled processing and error handling
- Software for multiprocessor communication
- Closed-loop controller algorithm (e.g. for pressure, temperature or flow control) with the following features: Output signal as manipulated variable or change in manipulated variable, parameterization via data block (fixed or variable values), limiting the output signal (high and low limits)

Depending on the job to be done, one to four CPUs 928 can be used in a central controller of the S5-135U or S5-155U programmable controllers, which are also suitable for multiprocessor operation with the following CPUs:

- CPU 948, CPU 928B, CPU 928 in the central controller of the S5-135U/155U.

Both time-controlled (clock: 10, 20, 100, 200, 500, 1000, 2000 and 5000 ms) and interrupt-driven program execution are possible.

## SIMATIC S5-135U, S5-155U/H

## Central processing units

## CPU 928A (continued)

4

Restart modes	
Cold restart with reset, manual	All bit memories, timers and counters are reset and the process image erased. Scanning of the user program starts at the beginning.
Warm restart, manual	The bit memories, timers, counters and the process image are retained during the down-time. Scanning of the user program continues at the point of interruption.
Warm restart, automatic	Following power recovery, the PLC automatically enters the RUN mode. The other data is as listed under warm restart, manual.
Overall reset	All memory areas are erased. The programmable controller enters the basic state. If a RAM is used, the user program must be loaded. If an EPROM is used, a cold restart with reset is possible. The overall reset function can be triggered by a switch on the processor or from the programming device.
The following start-up is possible if block DX 0 is programmed accordingly:	
Automatic restart	After voltage recovery the CPU returns automatically to the operating state. The other data is as listed under cold restart with reset, manual.

Technical specifications				
Microprocessors	8031 (8 bit) 80186 (16 bit), ASIC	analog additional additional	max. max. max.	192 256 for direct memory access <sup>1)</sup> 32,130 for page addressing <sup>2)</sup>
Memory space		Outputs	digital additional additional additional	max. max. max. max.
• RAM internal (for data blocks only)	46 Kbyte		analog additional additional	max. max. max.
• RAM internal or Memory card (flash EPROM); for program	max. 64 Kbyte		analog additional additional	max. max. max.
Execution time for		Program execution		192 256 for direct memory access <sup>1)</sup> 32,130 for page addressing <sup>2)</sup>
• 1 K binary statements (AND, OR)	1.1 ms			• Cycle (OB1) • Interrupt-driven • Time-controlled in 9 clock pulses
• 1 K digital statements (load, transfer)	15 ms	Current consumption (at 5 V)		
• 8 control loops	20 ms	• CPU 928A	max.	0.6 A
Number of control loops	max. 64 with standard function block "R64 controller structure" (see Section 7)	• Memory card	max.	0.2 A
Bit memories	2048	Power loss	max.	3 W
Timers		Space requirement		1 slot
• Number	256	Weight		
• Range	0.01 ... 9990 s	• CPU 928	approx.	0.5 kg (1.1 lb)
Counters		• Memory submodule	approx.	0.04 kg (0.088 lb)
• Number	256			
• Range	0 ... 999			
Inputs				
digital	max. 1024 with process image			
additional	max. 3072 without process image			
additional	max. 4096 for direct memory access <sup>1)</sup>			
additional	max. 518,152 for page addressing <sup>2)</sup>			

1) Only with IM 304, IM307, IM 308 interface modules.

2) Only with IM 308 interface module (theoretical end value).

Ordering data	Order No.	Order No.
<b>CPU 928</b> with receptacle for 1 memory submodule	<b>6ES5 928-3UA21</b>	<b>Memory card with flash EPROMs</b> 128 Kbyte (only 64 Kbyte usable)
<b>System manual, programming guide, manual</b>	see page 4/155	<b>6ES5 374-2KG21</b>

## CPU 928B

## Application



The CPU 928B is designed for mid-range applications. It is particularly suitable for high-speed word processing (arithmetic operations and closed-loop control) and high-speed binary signal processing (logic control).

In addition the module also has a second interface and is thus suitable for high-speed serial point-to-point connections or for connecting to the SINEC L1 LAN (slave or master with point-to-point connections).

It can be used in S5-135U and S5-155U.

4

## Design

The module contains the following:

- Arithmetic unit, microprogrammed, with bit and word processor (16 bit), for high-speed processing of binary and word statements
- Microprocessor (16 bit) for processing the operating program of the module
- Microprocessor (16 bit) for processing the built-in interface and the second optional serial interface
- Memory (RAM) for bit memories, S bit memories, timers, counters, process image, etc.
- Internal memory: 64 Kbyte for the user program and 46 Kbyte (RAM) for data of the user program (data blocks)
- Receptacle for SIMATIC memory card (FLASH EPROM) for max. 64 Kbyte user program. STEP 5 V6.6 and higher is required for programming and erasing the memory card.
- Programming device port (15-way Cannon socket)
- Receptacle for interface module; the following can be installed:
  - Second interface for programming device and operator panel;
  - V.24 interface;
  - TTY interface;
  - RS 422 A interface for point-to-point connections;
  - SINEC L1 interface
- Shift register (246 x 8 bit) with high processing speed
- Hardware clock
- Operating program for cyclic, time- and process-controlled processing and error handling
- Software for multiprocessor communication
- Closed-loop controller algorithm (e.g. for pressure, temperature or flow control) with the following features: Output signal as manipulated variable or change in manipulated variable, parameterization via data block (fixed or variable values), limiting the output signal (high and low limits)

- Driver for 3964, 3964R, RK512, "open driver"
- Special functions for cycle statistics

Depending on the job to be done, one to four CPUs 928B can be used in a S5-135U/155U central controller, which are also suitable for multiprocessor operation with the following CPUs:

- CPU 922, CPU 928, CPU 948 in the central controller of the S5-135U/155U

The CPU 928B functions on the same basis as, and is upwards-compatible with, the CPU 928. All STEP 5 commands for the CPU 928 can execute without modification on the CPU 928B.

## Restart modes

Cold restart with reset, manual	All bit memories, timers and counters are reset and the process image erased. Scanning of the user program starts at the beginning.
Warm restart, manual	The bit memories, timers, counters and the process image are retained during the down-time. Scanning of the user program continues at the point of interruption.
Warm restart, automatic	Following power recovery, the CPU automatically enters the RUN mode. The other data is as listed under warm restart, manual.
Overall reset	All memory areas are erased. The programmable controller enters the basic state. If a RAM is used, the user program must be loaded. If an EPROM is used, a cold restart with reset is possible. The overall reset function can be triggered by a switch on the processor or from the programming device.

## SIMATIC S5-135U, S5-155U/H

## Central processing units

## CPU 928B (continued)

## Design (continued)

## Restart modes (continued)

By parameterizing the DX 0 the following start-up is possible:

Cold restart, automatic  
(without memory)

Following power recovery, the CPU goes to RUN mode automatically.  
Otherwise the same as cold restart with reset, manual.

Cold restart, automatic  
(with memory)

Following power recovery, scanning of the user program starts at the  
beginning. All bit memories, timers and counters are retained.

4

## Technical specifications

Microprocessors	80186 (16 bit) 80188 (16 bit)	analog additional additional	max. max. max.	192 256 for direct memory access <sup>1)</sup> 32,130 for page addressing <sup>2)</sup>
Memory space		Outputs	digital additional additional additional	max. max. max. max.
• RAM internal (for data blocks only)	46 Kbyte			1024 with process image 3072 without process image 4096 for direct memory access <sup>1)</sup> 518,152 for page addressing <sup>2)</sup>
• RAM internal or Memory card (flash EPROM); for program	max. 64 Kbyte		analog additional additional	max. max. max.
Execution time for		Program execution		192 256 for direct memory access <sup>1)</sup> 32,130 for page addressing <sup>2)</sup>
• 1 K binary statements	0.6 ms			• Cycle (OB1) • Interrupt-driven • Time-controlled in 9 clock pulses • Clock-controlled
• 1 K word statements	1.5 ms			
• 8 control loops	20 ms			
Scan time monitoring	Programmable, default: 200 ms			
Number of control loops	max. 64 with standard function block "R 64 controller structure" (see Section 7)	Current consumption (at 5 V)		
Bit memories	2048	• CPU 928B	typ.	0.6 A
S bit memories	8192	• Memory card	max.	0.2 A
Timers		• 377 memory submodule (RAM)	max.	0.1 A
• Number	256	• Interface modules		0.1 ... 0.2 A
• Range	0.01 ... 9990 s	• Power loss	max.	3 W
Counters		Space requirements		1 slot
• Number	256	Weight		
• Range	0 ... 999	• CPU 928B	approx.	0.5 kg (1.1 lb)
Inputs	digital max. 1024 with process image additional max. 3072 without process image additional max. 4096 for direct memory access <sup>1)</sup> additional max. 518,152 for page addressing <sup>2)</sup>	• Memory submodule	approx.	0.04 kg (0.088 lb)

1) Only with IM 304, IM 307, IM 308 interface modules.

2) Only with IM 308 interface module (theoretical end value).

## Ordering data

	Order No.		Order No.
<b>CPU 928 B</b> with receptacle for 1 memory submodule and receptacle for 1 interface module	<b>6ES5 928-3UB21</b>	<b>Memory card with flash EPROMs</b> 128 Kbyte (only 64 Kbyte usable)	<b>6ES5 374-2KG21</b>
<b>System manual, programming guide, communications manual, instruction manual</b>	see page 4/155	<b>Interface module</b> for 20 mA current loop (TTY) for V.24 (RS 232C) for RS 422-A/RS 485 for SINEC L1	<b>6ES5 752-0AA12</b> <b>6ES5 752-0AA23</b> <b>6ES5 752-0AA43</b> <b>6ES5 752-0AA53</b>
		<b>COM PP parameter assignment software</b>	<b>6ES5 752-0AA62</b> see Section 7

## SIMATIC S5-135U, S5-155U/H

## Central processing units

## CPU 948

## Application



The CPU 948 is the high-speed memory giant for the S5-155U. It is the most powerful CPU and is designed for applications in the upper performance range. It has a large user memory and is suitable for both very high-speed word

processing (arithmetic operations and closed-loop control) and very high-speed binary signal processing (logic control). The CPU 948 is fully compatible with its predecessors, the CPU 946/947.

4

## Design

The module contains the following:

- STEP 5 processing unit (with 2 ASICs) for processing the user program
- Microprocessor (16 bit) for processing the operating system of the module
- Microprocessor (16 bit) for processing the built-in interface and the second optional serial interface
- Memory (RAM) for bit memories, S bit memories, timers, counters, process image, etc.
- Internal memory (RAM) with 640 or 1664 Kbyte for the user program
- Receptacle for SIMATIC memory card (flash EPROMs)
- Hardware clock

## • Interfaces

1. Built-in serial interface (TTY) for programming device or operator panel
2. Slot for interface module for programming device; V.24 interface; TTY interface; RS 422 A interface for point-to-point connections; SINEC L1 interface

Depending on the job to be done, up to 4 CPUs 948 can be used in a central controller of the S5-155U programmable controller; they are also suitable for multi-processor operation with CPU 948B, CPU 928 and CPU 922.

The user programs can be stored in the integral RAM (640 or 1664 Kbyte). If necessary, the programming device can be used to store the user program on a flash EPROM to protect it from power failures.

The CPU 948 is fully compatible with the CPUs 946/947. It is not necessary to modify existing programs.

## Functions

## Program execution

- Cyclic program execution; Read-in of input statuses, execution of the control program and output of the output statuses
- Time-controlled program execution; 9 independent time-controlled program execution levels. The time of processing can be defined separately for each level. Times between 10 ms and 20 min can be set. A time-controlled timed interrupt is also available
- Interrupt-controlled program execution; via interrupts or process alarms; 4 interrupts via signal lines of the internal S5 backplane bus; 8 process alarms via input byte IB 0

- Time interrupt-controlled program processing; This execution level is activated after expiry of a programmed time (time resolution: 1 ms)

Execution levels of higher priority can interrupt execution levels of lower priority after each STEP 5 operation.

## Monitoring

- Scan time
- Collision of two timed interrupts
- Addressing error
- Acknowledgement delay

## Time

- Set, read, interrupt
- Operating hours counter

## Integral function blocks

- Including, for example
- Disable or delay interrupts
  - Delete or generate blocks
  - Transfer process images
  - Copy data blocks

## Hardware self-test functions

- Including, for example, RAM test, BASP (output disable) test and clock test

## Further functions

- Easy access to the extended I/O area via function block FB 196 (contained in the "Basic functions" program package, (see Section 7))
- Programming device functions via the internal S5 backplane bus, thus providing fast program loading via the Industrial Ethernet bus system
- Password protection of the user program



## SIMATIC S5-135U, S5-155U/H

## Central processing units

## CPU 948 (continued)

## Design (continued)

Restart modes	
Cold restart with reset, manual	All bit memories, timers and counters are reset and the process image erased. Scanning of the user program starts at the beginning.
Warm restart, manual	The bit memories, timers, counters and the process image are retained during the down-time. Scanning of the user program continues at the point of interruption.
Warm restart, automatic	Following power recovery, the PLC automatically enters the Run mode. The other data is as listed under warm restart, manual.
The following start-up is possible if block DX 0 is programmed accordingly:	
Cold restart, automatic	Following power recovery, the programmable controller automatically enters the RUN mode. The other data is as listed under cold restart with reset, manual.
Cold restart with memory, manual	The bit memories, timers, counters and the process image are retained during the down-time. Scanning of the user program continues at the point of interruption.
Cold restart with memory, automatic	Following power recovery, the programmable controller automatically enters the RUN mode. The other data is as listed under cold restart with memory, manual.

4

## Technical specifications

Microprocessors	80186 (16 bit) 80188 (16 bit), 2 ASICs	Outputs	digital	max.	1024 with process image
Total memory space			additional	max.	3072 without process image
• Internal memory	640 Kbyte or 1664 Kbyte		additional	max.	4096 for direct memory access <sup>1)</sup>
• Memory submodule (flash EPROM)	640 Kbyte or 1164 Kbyte		additional	max.	518152 for page addressing <sup>2)</sup>
Programming language	STEP 5, SCL		analog	max.	192
Block types	Organization blocks (OB), Programming blocks (PB), Function blocks (FB, FX), Data blocks (DB, DX)	Bit memories	additional	max.	256 for direct memory access <sup>1)</sup>
Number of blocks	max. 256 per block type	S bit memories	additional	max.	32,130 for page addressing <sup>2)</sup>
Nesting depth of the blocks	60	Nesting levels			8
Program execution	• Cyclic (OB1) • Interrupt-driven • Time-controlled • Operator-controlled stop	Timers			
Execution times for		• Number			256
• Bit operations	0.18 µs	• Range			0.01 ... 9990 s
• Word operations	0.5 µs	Counters			
• Time/counter operations	0.18 µs	• Number			256
• Fixed-point addition	0.55 µs	• Range			0 ... 999
• Floating-point addition	3.3 µs	Interfaces			
Scan time monitoring	Programmable, default: 200 ms	1st interface (integral)			programming device/operator
Inputs		2nd interface (optional)			panel depending on interface
digital	max. 1024 with process image	Current consumption (at 5 V)			module used
additional	max. 3072 without process image	• CPU 948	max.		3.6 A
additional	max. 4096 for direct memory access <sup>1)</sup>	• Memory card	max.		0.2 A
additional	max. 518,152 for page addressing <sup>2)</sup>	• Interface module	max.		0.1 ... 0.2 A
analog	max. 192	Power loss	max.		20 W
additional	max. 256 for direct memory access <sup>1)</sup>	Space requirements			2 slots
additional	max. 32,130 for page addressing <sup>2)</sup>	Weight			
		• CPU 928	approx.		1 kg (2.2 lb)
		• Memory submodule	approx.		0.06 kg (0.13 lb)

1) Only with IM 304, IM 307, IM 308 interface modules.

2) Only with IM 308 interface module (theoretical end value).

# SIMATIC S5-135U, S5-155U/H

## Central processing units

### CPU 948 (continued)

Ordering data	Order No.	Order No.
<b>CPU 948</b> <ul style="list-style-type: none"> <li>• With 640 Kbyte user memory</li> <li>• With 1664 Kbyte user memory</li> </ul>	<b>6ES5 948-3UA11</b>	
<b>System manual, programming instructions, manual</b>	<b>6ES5 948-3UA21</b>	
<b>Memory card</b> with flash EPROMs Memory capacity: 256 Kbyte 1 Mbyte 2 Mbyte	see page 4/155	
	<b>6ES5 374-2KH21</b> <b>6ES5 374-2KK21</b> <b>6ES5 374-2KL21</b>	
<b>Programming adapter</b> (for memory cards)	<b>6ES5 985-2MC11</b>	
		<b>Interface module</b> for 20 mA current loop (TTY) for V.24/V.28 (RS 232C) for RS 422-A/RS 485 for programming device for SINEC L1
		<b>COM PP parameter assignment software</b>
		<b>6ES5 752-0AA12</b> <b>6ES5 752-0AA22</b> <b>6ES5 752-0AA43</b> <b>6ES5 752-0AA53</b> <b>6ES5 752-0AA62</b> see Section 7

4

On account of the higher CPU speed, it is necessary to make adjustments to the standard function blocks in the case of the intelligent I/O modules.

Please check that the version numbers of your standard function block comply with the required minimum version, by referring to the following table.

Module	FB numbers concerned	Standard FB can be used from
IP 240	167 to 173	V 2.2
IP 241	156 to 158	A 04
IP 242 A (...-1AA3.)	178 to 182	A 02
IP 242 B (...-1AA41)	183, 184	A 03
IP 243	160, 161	A 02
IP 244	162	A 03, B 03, C 04
IP 246	164, 165	A 02
IP 247	164, 165	A 02
IP 252	100, 101	V 3.0
IP 260	170	A 02
IP 261	171	Not implementable
IP 281	(no FB)	Implementable due to direct access

# SIMATIC S5-135U, S5-155U/H

## Central processing units

### 923A and 923C coordinators

#### Application

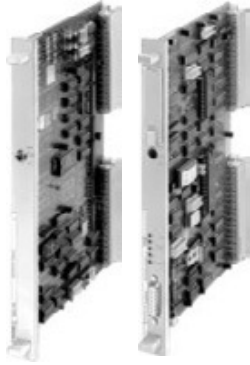

Several CPUs can be used in one central controller, depending on the task to be performed. The 923A/C coordinators allocate access rights to the internal S5 bus to the individual CPUs.

#### 923A coordinator

The 923A coordinator is used for coordinating access of from two to four CPUs in the S5-135U and S5-155U programmable controllers.

#### 923C coordinator

The 923C coordinator is used for coordinating access of from two to four CPUs in the S5-135U and S5-155U programmable controllers and for programming and start-up of up to eight CPUs and communications processors. The coordinator also enables the programmable controller to be programmed via the Industrial Ethernet, PROFIBUS and SINEC L1 LANs.

#### Design

##### 923A coordinator

The module contains the following:

- Memory (RAM) for 2048 interprocessor communication bit memories
- Clock generator and scaler for producing the time base on which access to the S5 bus is allocated among the CPUs

##### 923C coordinator

The module contains the following:

- RAM for 2048 interprocessor communication bit memories and for data blocks

- Clock generator and scaler for producing the time base on which the internal S5 backplane bus is allocated to the CPUs
- Central programming device port with multiplexer: With the programming device connected to a 923C coordinator, the user can program up to eight processors without changing the front connectors

For programming a programmable controller via the Industrial Ethernet, PROFIBUS and SINEC L1 local area network, the programming device ports of the 923C coordinator and the CP 143, CP 5430 or CP 530 communications processors need to be linked by means of the 725 connecting cable.

The central programming device interface can only be operated if the S5-DOS operating system is loaded in the programming device.

#### Principle of operation

Each CPU communicates with the input and output modules via the internal S5 backplane bus. The coordinator allocates access rights to the S5 back-

plane bus to each CPU in cycles (time-sharing). The allocation sequence is fixed (CPU 1 - CPU 2 - CPU 3 - CPU 4).

The CPUs can exchange information via interprocessor communication bit memories in the coordinator.

#### Technical specifications

##### Current consumption (at 5 V)

- 923A coordinator max. 0.5 A
- 923C coordinator max. 1.1 A

##### Power loss

- 923A coordinator max. 2.5 W
- 923C coordinator max. 6 W

Space requirements approx. 1 slot

Weight 0.3 kg (0.7 lb)

#### Ordering data

Order No.

Order No.

##### 923A coordinator

The operating instructions are included in the S5-135U/155U system manual (see page 4/155).

**6ES5 923-3UA11**

##### 725 connecting cable

for connecting 923C coordinator to the CP 143 or CP 530 communications processor  
0.9 m (3 ft)  
2.5 m (8 ft)

**6ES5 725-0AK00**  
**6ES5 725-0BC50**

##### 923C coordinator

The operating instructions are included in the S5-135U/155U system manual (see page 4/155).

**6ES5 923-3UC11**

## SIMATIC S5-135U, S5-155U/H

## Central processing units

## CPU 948R/RL for S5-155H/S5-155H Lite

## Application



The CPU 948R is designed for the S5-155H fault-tolerant programmable controller, the CPU 948RL for the S5-155H Lite.

They have a large user memory and are suitable for both high-speed word processing (arithmetic operations and closed-loop control) and high-speed binary signal processing (logic control).

4

## Design

The CPU 948R/RL differs only in its firmware from the CPU 948 for the S5-155U programmable controller. You must plug in a CPU 948R/RL into both subunits of the S5-155H/-155H Lite fault-tolerant programmable controller.

The module contains the following:

- STEP 5 processing unit (with 2 ASICs) for processing the user program

- Microprocessor (16 bit) for processing the operating system of the module
- Microprocessor (16 bit) for processing the built-in serial interface
- Internal memory (RAM) with 128, 640 or 1664 Kbyte for the user program (355 memory submodule and RAM memory submodules are no longer required)

- Memory (high-speed RAM) for bit memories, S bit memories, timers, counters, process image, etc.
- Receptacle for memory card (flash EPROMs, non-volatile and electrically erasable)
- Hardware clock
- Built-in serial interface (TTY) for programming device or operator panel

The CPU 948R requires 2 slots. It can be plugged into the ZG 135U/155U central controller.

## Principle of operation

Depending on the application, the central processing unit executes the user program either cyclically, time-controlled, interrupt-controlled or time interrupt-controlled. The firmware executes all additional functions of the fault tolerant programmable controller S5-155H/-155H Lite automatically.

These functions include the following:

- Data exchange
- Synchronization of the two subunits
- Self-test
- Fault handling (switchover to standby unit)
- Fault locating

Multi-processor operation as with the CPU 948 is not possible with the CPU 948RL. The additional functions (self-test, synchronization, fault locating) increase the execution time by 5 to 15 %.

## Functions

- Event-driven synchronization
- Transparent programming
- Any combination of 1-, 2- and 3-channel I/O configuration (3-channel configuration only for inputs)
- Support of redundant analog inputs and outputs with fault detection and fault locating

- Comprehensive self-test functions
- Comprehensive system diagnostics functions
- Single-channel and redundant connection to the SINEC L1, PROFIBUS and Industrial Ethernet LANs
- Single-channel and redundant connection to the PROFIBUS-DP field bus

- Programming device functions via the Industrial Ethernet LAN

For further information on functions, program execution and restart modes, refer to the description of the CPU 948 on page 4/27.

## Programming

In addition to programming in STEP 5, the CPU 948R/RL can also be programmed with the SCL compiler in the SCL programming language. The SCL high-level language is a programming language similar to PASCAL which has been optimized for PLC applications.

SCL can be used for programming complex tasks simply and easily in the SIMATIC S5. The SCL compiler is integrated in the STEP 5 basic package S5-DOS/MT, Version 6.

The user programs can be stored in the integral RAM (128, 640 or 1664 Kbyte). If necessary, the programming device can be used to store the user program on a flash EPROM to protect it from power failures. For this purpose, a programming adapter is required.

## SIMATIC S5-135U, S5-155U/H

## Central processing units

## CPU 948R/RL for S5-155H/S5-155H Lite (continued)

## Technical specifications

Microprocessors	80186 (16 bit) 80188 (8 bit), 2 ASICs	Inputs	analog	max.	CPU 948RL: 192 (1-, 2- or 3-channel)
Total memory space					CPU 948RL: 64 (1- or 2-channel)
• Internal memory (RAM)	128 Kbyte (CPU 948RL) 640 or 1664 Kbyte (CPU 948R)		additional	max.	384 for direct memory access (1-channel)
• Memory submodule (flash EPROM)	128 Kbyte (CPU 948RL) 640 or 1664 Kbyte (CPU 948R)	Outputs	digital	max.	32,130 for page addressing <sup>1)</sup>
Programming language	STEP 5, SCL				1024 with process image (1- or 2-channel)
Program execution	• Cycle (OB1), • Interrupt-driven • Time-controlled • Operator-controlled stop		additional	max.	3072 without process image (1-channel)
Execution times for					6144 for direct memory access
• Bit operations	0.18 µs		analog	max.	518,152 for page addressing <sup>1)</sup>
• Word operations	0.5 µs		CPU 948RL	max.	CPÜ 948R: 192 (1- or 2-channel)
• Timer/counter operations	14/0.18 µs		additional	max.	CPÜ 948RL: 64 (1- or 2-channel)
• Fixed-point addition	0.55 µs		additional	max.	384 for direct memory access
• Floating-point addition	3.3 µs	Bit memories/S bit memories			32,130 for page addressing <sup>1)</sup>
Basic cycle time	typ. 10 ms (CPU 948R) 20 ms (CPU 948RL)	Timers			2048/32768
Scan time monitoring	Programmable, default: 200 ms	• Number/Range			256/0.01 to 9990 s
Inputs		Counters			256/0 to 999
digital	max. 1024 with process image (1-, 2- or 3-channel) <sup>2)</sup>	• Number/Range			
additional	max. 3072 without process image (1-channel)	Current consumption (at 5 V DC)			
additional	max. 6144 for direct memory access (1-channel)	• CPU 948R	max.		3.6 A
additional	max. 518,152 for page addressing <sup>1)</sup>	• Memory card			0.2 A
		Power loss	max.		20 W
		Space requirements			2 slots
		Weight	approx.		1 kg (2.2 lb)

1) Only with IM 308 interface module (theoretical end value).

2) 3-channel not possible with CPU 948RL.

## Ordering data

## CPU 948R

For S5-155H  
With 640 Kbyte user memory  
With 1664 Kbyte user memory

6ES5 948-3UR12  
6ES5 948-3UR22

## CPU 948RL

For S5-155H Lite  
With 128 Kbyte user memory

6ES5 948-3UR51

## Memory card (flash EPROM)

256 Kbyte  
1 Mbyte  
2 Mbyte

6ES5 374-2KH21  
6ES5 374-2KK21  
6ES5 374-2KL21

## ZG 135U/155U subrack

230 V/115 V AC; 5 V, 18 A  
230 V/115 V AC; 5 V, 40 A  
24 V DC; 5 V, 18 A  
24 V DC; 5 V, 40 A

6ES5 188-3UA12  
6ES5 188-3UA22  
6ES5 188-3UA32  
6ES5 188-3UA52

## ZG 155H subrack

24 V DC; 5 V, 14 A

6ES5 188-3UH31

## COM 155H parameterization software

for configuration and diagnostics of the S5-155H fault-tolerant PLC on 3 1/2" diskettes,  
Single license  
Copy license

6ES5 895-3SR 3  
6ES5 895-3SR 3-OKL1  
↑  
1  
2  
3

German  
English  
French

To be ordered as a separate item:

## S5-155H manual

consisting of the S5-155H operating instructions, the programming instructions and the CPU 948R/RL quick reference

German  
English  
French

6ES5 998-4SR11  
6ES5 998-4SR21  
6ES5 998-4SR31

## S5-135U/155U system manual

consisting of the descriptions of the central controllers (CC) and expansion units (EU), the interface modules (IM), the power supply and the I/Os

German  
English  
French

6ES5 998-0SH11  
6ES5 998-0SH21  
6ES5 998-0SH31

## Overview

Digital input/output modules					
Input modules			Output modules		
Voltage values	Module ID	Page	Voltage values/ current values	Module ID	Page
5... 15 V DC	434-4	4/33	Transistor outputs	441-4	4/38
24 V DC	420-4	4/33	24 V DC; 0.5 A	451-4	4/38
	430-4	4/33			
	432-4	4/33			
24/48/60 V DC	431-4	4/33	24 V DC; 2 A	453-4	4/38
				454-4	4/38
24/48/60 V AC	435-4	4/33	24/48/60 V DC; 0.5 A	457-4	4/38
115 V AC	436-4UA	4/33	24/48/60 V AC; 2 A	455-4	4/38
	436-4UB	4/33			
230 V AC	436-4UA	4/33	115/230 V AC; 2 A	456-4UA	4/38
	436-4UB	4/33		456-4UB	4/38
230 V AC	436-4UA	4/33	Relay outputs		
	436-4UB	4/33	60 V DC; 0.5 A	458-4UA	4/38
230 V AC	436-4UA	4/33	250 V AC; 5A	458-4UB	4/38
	436-4UB	4/33			
230 V AC	436-4UA	4/33			
	436-4UB	4/33			
230 V AC	436-4UA	4/33			
	436-4UB	4/33			
			<b>Input/output modules</b>		
			Voltage values/ current values	Module ID	Page
			24 V DC (inputs), 24 V DC; 0.5 A (outputs)	482-4	4/43

## Digital input modules

## Application

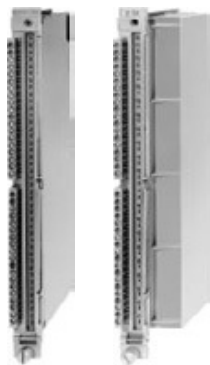

The digital input modules convert the external binary signals from the process to the internal signal level of the programmable controllers.

## Design

Digital input modules with 32, 16 and 8 inputs for a range of input voltages are available. The modules require either one or two slots.

Front connectors are used for terminating the signal cables. Both modules and front connectors may be inserted and removed under power.

Green LEDs indicate the signal status of the inputs. Adhesive labels are supplied to identify the modules and front connectors.

## Principle of operation

## Enable input

The input signals can be disabled by means of the enable input F. This enable input can be deactivated by removing a jumper on the module.

## Interrupt processing

The 432-4 digital input module generates an interrupt when an input signal changes:

- In the central controller, an interrupt line is provided for each CPU. Modules must be plugged into the central controller

- The CPU 948 has a mode of operation available which recognizes an interrupt by scanning the input byte 0. All modules (max. 8) used for interrupt generation must be accommodated in the same unit.

## SIMATIC S5-135U, S5-155U/H

## Digital input/output modules

## Digital input modules (continued)

Technical specifications				
Digital input module	6ES5 420-4UA14	6ES5 430-4UA14	6ES5 431-4UA12	6ES5 432-4UA12 <sup>1)</sup>
<b>Number of inputs</b>	<b>32</b>	<b>32</b>	<b>16</b>	<b>32</b> (with a group signal)
Galvanic isolation	No	Yes	Yes	Yes
• In groups of	—	32	1	8
<b>Input voltage</b> (rated value)	<b>24 V DC</b>	<b>24 V DC</b>	<b>24/48/60 V DC</b>	<b>24 V DC</b>
Input voltage				
• For "0" signal	- 33 ... + 5 V	- 3 ... + 7 V	- 33 ... + 8 V	- 33 ... + 5 V
• For "1" signal	+ 13 ... + 33 V	+ 13 ... + 33 V	+ 13 ... + 72 V	+ 13 ... + 33 V
Input current				
• For "1" signal	typ. 8.5 mA	7 mA	4.5 mA (at 24 V) 6.5 mA (at 48 V) 7.5 mA (at 60 V)	8.5 mA
Delay	1.4 ... 5 ms	2.5 ... 6.5 ms	1.4 ... 5 ms	3 ms/1 ms/0.3 ms
Cable length				
• Unshielded	max. 600 m (1968 ft)	600 m (1968 ft)	400 m (1312 ft)	600 m (1968 ft) (3 ms) 200 m (656 ft) (1 ms) 50 m (164 ft) (0.3 ms)
• Shielded	max. 1000 m (3280 ft)	1000 m (3280 ft)	1000 m (3280 ft)	1000 m (3280 ft)
<b>Enable input F</b>				
Input voltage				
• Rated value	24 V DC	24 V DC	24/48/60 V DC	24 V DC
• Enable	+ 13 ... + 33 V	+ 13 ... + 33 V	+ 13 ... + 72 V	+ 13 ... + 33 V
• Disable	- 33 ... + 5 V	- 33 ... + 5 V	- 33 ... + 8 V	- 33 ... + 5 V
Input current of enable input	typ. 5 mA	5 mA	5 mA (at 48 V)	5 mA
Cable length (unshielded)	max. 200 m (656 ft)	200 m (656 ft)	200 m (656 ft)	200 m (656 ft)
Insulation voltage (external connections to housing)				
• In acc. with VDE 0160	—	75 V DC	75 V DC	75 V DC
• Tested with	—	1250 V AC	1250 V AC	1250 V AC
<b>Supply voltage</b> $V_{pos}$				
• Rated value	—	24 V DC	—	—
• Ripple $V_{pp}$ (referred to rated voltage)	max. —	+ 15 %	—	—
• Permissible range (including ripple)	—	20 ... 30 V	—	—
• Value at <0.1 s	max. —	36 V	—	—
Current consumption				
• Internal (at 5 V)	typ. 80 mA	100 mA	90 mA	200 mA
• External (at 24 V)	typ. —	100 mA	—	—
Power loss	max. 7.0 W	8.3 W	2.2 ... 7.7 W (at 24 ... 60 V)	7.5 W
Space requirements	1 slot	1 slot	1 slot	1 slot
Front connector	42-pin	42-pin	42-pin	42-pin
Weight	approx. 0.4 kg (0.88 lb)	0.4 kg (0.88 lb)	0.4 kg (0.88 lb)	0.4 kg (0.88 lb)

1) A shielded signal lead is required for use of the module.

A filter (SIFI C, B841 13-C-B30 or equivalent) is required in the 24 V DC load power supply for the module.

## Digital input modules (continued)

Technical specifications (continued)					
Digital input module		6ES5 434-4UA12	6ES5 435-4UA12	6ES5 436-4UA12 <sup>1)</sup>	6ES5 436-4UB12 <sup>1)</sup>
<b>Number of inputs</b>		<b>32</b>	<b>16</b>	<b>16</b>	<b>8</b>
Galvanic isolation		Yes	Yes	Yes	Yes
• In groups of		32	8	8	1
<b>Input voltage</b> (rated value)		<b>TTL signals (+ 5 V)</b> <b>CMOS signals (+ 15 V)</b> <b>signals from NAMUR sensors</b> (with current output in acc. with DIN 19234)	<b>24/48/60 V AC</b> (47 ... 63 Hz)	<b>115/230 V AC</b> (47 ... 63 Hz)	<b>115/230 V AC</b> (47 ... 63 Hz)
Input voltage		0 ... + 0.8 V (TTL)	0 ... 15 V	0 ... 60 V	0 ... 60 V
• For "0" signal		0 ... + 4.5 V (CMOS)			
• For "1" signal		+ 2.4 ... + 5 V (TTL) or open input + 10.5 ... + 15 V (CMOS) or open input	20 ... 72 V	90 ... 264 V	90 ... 264 V
Input current					
• For "0" signal	typ.	- 1 mA (TTL) - 3 mA (CMOS) ≤ 1.2 mA (NAMUR)	—	—	—
• For "1" signal	typ.	0.1 mA (TTL) 0.3 mA (CMOS) ≥ 2.1 mA (NAMUR)	15 mA (at 48 V) 20 mA (at 60 V)	15 mA (at 115 V) 25 mA (at 230 V)	15 mA (at 115 V) 25 mA (at 230 V)
Delay					
• Positive edge		1.4 ... 5 ms	2 ... 15 ms	2 ... 15 ms	2 ... 15 ms
• Negative edge		1.4 ... 5 ms	10 ... 25 ms	10 ... 25 ms	10 ... 25 ms
Cable length					
• Unshielded	max.	200 m (656 ft) (TTL/CMOS) 600 m (1968 ft)/ (NAMUR)	600 m (1968 ft)  1000 m (3280 ft)	600 m (1968 ft)  1000 m (3280 ft)	600 m (1968 ft)  1000 m (3280 ft)
• Shielded	max.	1000 m (3280 ft)			
<b>Enable input F</b>			Jumper F+/F- in the front connector	Jumper F+/F- in the front connector	Jumper F+/F- in the front connector
Input voltage					
• Rated value		5/15/24 V DC			
• Enable		+ 4 ... + 33 V			
• Disable		- 15 ... + 2 V			
Input current of enable input	typ.	5 mA			
Cable length (unshielded)	max.	100 m (328 ft)			
Insulation voltage (External connections to housing)		75 V DC	250 V AC	250 V AC	250 V AC
• In acc. with VDE 0160		1250 V AC	1500 V AC	1500 V AC	1500 V AC
• Tested with					
<b>Supply voltage</b> V <sub>pos</sub>		24 V DC (L+); 15 V DC (LH+)	—	—	—
• Rated value					
• Ripple V <sub>pp</sub> (referred to rated voltage)	max.	15 %	—	—	—
• Permissible range (including ripple)		20 ... 30 V; 5...15 V	—	—	—
• Value at t < 0.1 s	max.	36 V	—	—	—
Current consumption					
• Internal (at 5 V)	typ.	80 mA	100 mA	100 mA	80 mA
• External (at 24 V)	typ.	200 mA			
• External (at 15 V)	typ.	300 mA			
Power loss	max.	5.5 W	3.5 W (at 24 V) 18.0 W (at 60 V)	3.5 W (at 115 V) 17.0 W (at 230 V)	2.0 W (at 115 V) 8.5 W (at 230 V)
Space requirements		1 slot	2 slots	2 slots	2 slots
Front connector		42-pin	20-pin	20-pin	20-pin
Weight	approx.	0.4 kg (0.88 lb)	0.4 kg (0.88 lb)	0.4 kg (0.88 lb)	0.4 kg (0.88 lb)

1) A filter (SIFI C, B84113-C-B30 or equivalent) is required in the 230 V AC load power supply for the module.



## SIMATIC S5-135U, S5-155U/H

## Digital input/output modules

## Digital input modules (continued)

Ordering data	Order No.		Order No.
<b>Non-floating</b>			
<b>420-4 digital input module</b> 32 inputs, 24 V DC	<b>6ES5 420-4UA14</b>	<b>436-4UB digital input module</b> 8 inputs, 115/230 V AC	<b>6ES5 436-4UB12</b>
<b>Floating</b>		The operating instructions are included in the S5-135U/155U system manual (see page 4/155).	
<b>430-4 digital input module</b> 32 inputs, 24 V DC	<b>6ES5 430-4UA14</b>	<b>497 front connector</b>	
<b>431-4 digital input module</b> 16 inputs, 24/48/60 V DC	<b>6ES5 431-4UA12</b>	Crimp terminals, single-width, 42-pin	<b>6ES5 497-4UA12</b>
<b>432-4 digital input module</b> for interrupt processing, 32 inputs, 24 V DC	<b>6ES5 432-4UA12</b>	Crimp terminals, double-width, 42-pin	<b>6ES5 497-4UA22</b>
<b>434-4 digital input module</b> 32 inputs, 5/15 V DC (TTL, CMOS, NAMUR)	<b>6ES5 434-4UA12</b>	Crimp terminals, double-width, 20-pin	<b>6ES5 497-4UA42</b>
<b>435-4 digital input module</b> 16 inputs, 24/48/60 V AC	<b>6ES5 435-4UA12</b>	Screw terminals, single-width, 42-pin	<b>6ES5 497-4UB31</b>
<b>436-4UA digital input module</b> 16 inputs, 115/230 V AC	<b>6ES5 436-4UA12</b>	Screw terminals, double-width, 42-pin	<b>6ES5 497-4UB12</b>
		Screw terminals, double-width, 20-pin	<b>6ES5 497-4UB42</b>

# SIMATIC S5-135U, S5-155U/H

## Digital input/output modules

### Digital input modules (continued)

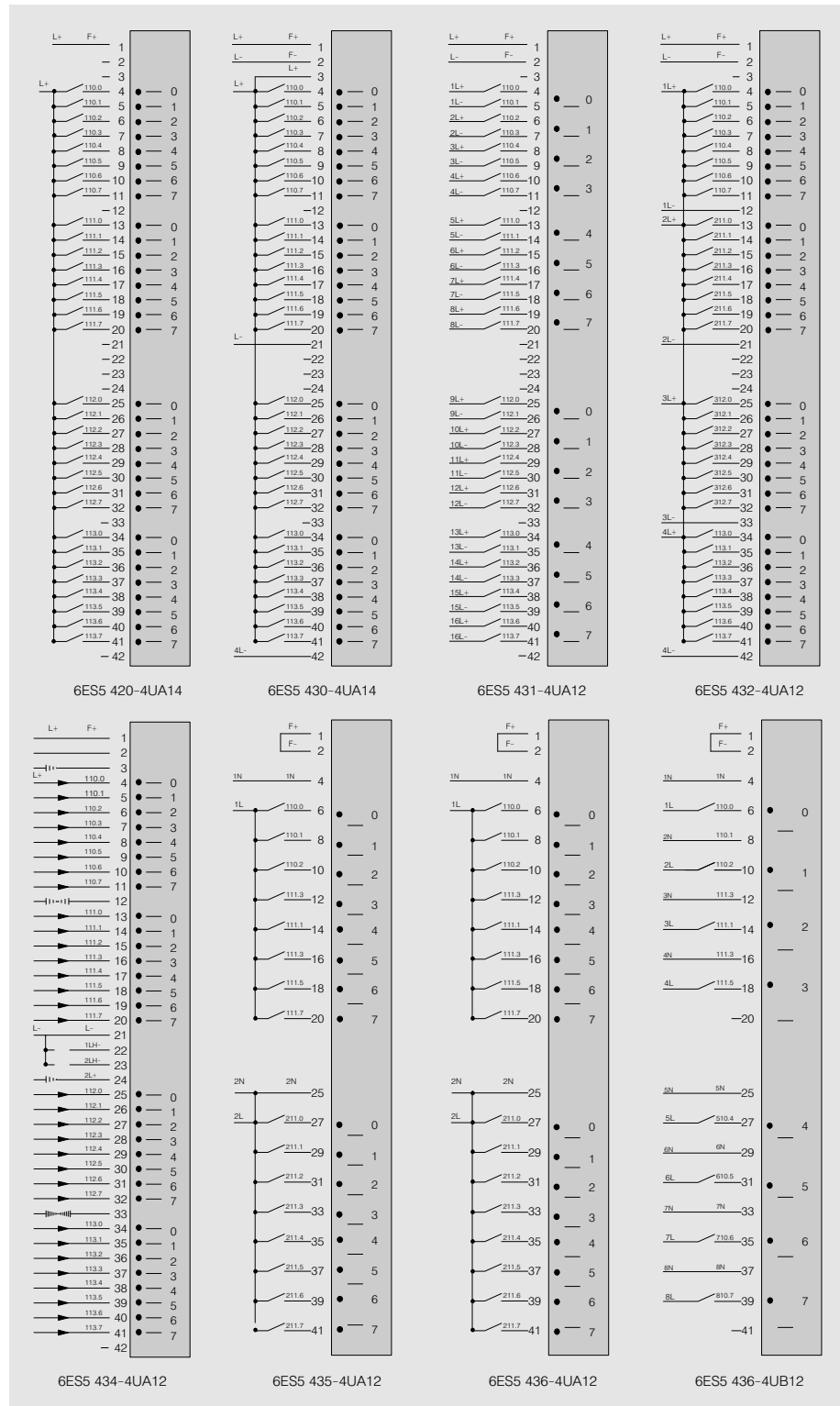

Fig. 4/23 Connection diagrams of the digital input modules

# SIMATIC S5-135U, S5-155U/H

## Digital input/output modules

### Digital output modules

#### Application

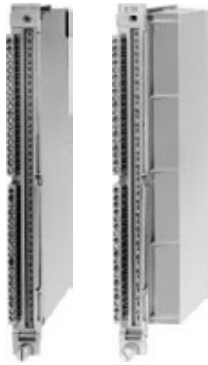

The digital output modules convert the internal signal levels of the programmable controllers into the binary signal levels required externally by the process.

4

#### Design

Digital output modules with 32, 16 and 8 outputs are available with a range of output voltages and also with relay contact outputs. The modules require either one or two slots.

Front connectors are used for terminating the signal cables. Modules and front connectors may be inserted and removed under power.

Green LEDs indicate the signal status of the outputs. In DC output modules, red LEDs indicate short-circuits in the signal leads. The signal output H is set to "1" if an over-current or short-circuit is detected in an output. Up to 16 signal outputs can be connected in parallel. In AC output modules, red LEDs indicate when a fuse has blown.

Adhesive labels are supplied to identify modules and front connectors.

#### Principle of operation

##### Enable input

The output of signals can be suppressed by an enable

input F. This function can be deactivated by removing a jumper on the module.

## Digital output modules (continued)

Technical specifications					
Digital output module	6ES5 441-4UA14	6ES5 451-4UA14	6ES5 453-4UA12 <sup>4)</sup>	6ES5 454-4UA14 <sup>5)</sup>	6ES5 455-4UA12
<b>Number of outputs</b>	<b>32</b>	<b>32</b>	<b>16</b>	<b>16</b>	<b>16</b>
Galvanic isolation	No	Yes	Yes	Yes	Yes
• In groups of	—	32	1	16	8
<b>Supply voltage</b> $V_p$ , $V_{pos}$					
• Rated value	<b>24 V DC</b>	<b>24 V DC</b>	<b>24 V DC<sup>1)</sup></b>	<b>24 V DC</b>	<b>24/48/60 V AC</b>
• Frequency					47 to 63 Hz
• Ripple $V_{pp}$ (referred to rated voltage) max.	15 %	15 %	15 %	15 %	—
• Permissible range (including ripple)	20 ... 30 V	20 ... 30 V	20 ... 30 V	20 ... 30 V	20 ... 72 V
• Value at <0.1 s max.	36 V	36 V	36 V	36 V	—
<b>Output current</b> at "1" signal					
• Rated value	<b>0.5 A</b>	<b>0.5 A</b>	<b>2 A</b>	<b>2 A</b>	<b>2 A</b>
• Permissible range	5 mA ... 0.5 A	5 mA ... 0.5 A	10 mA <sup>2)</sup> ... 2 A	10 mA <sup>2)</sup> ... 2 A	0.4 ... 2 A
• Making current per group for $t < 3 / < 20 / < 50$ ms max.					25/15/13 A
Lamp load max.	5 W	5 W	10 W	10 W	25 W
Short-circuit protection	Electronic	Electronic	Electronic	Electronic	Fuse (4x6.3 A)
Limitation of the voltage induced on circuit interr. (int.) to	$V_{pos} - 47$ V	$V_{pos} - 47$ V	$V_{pos} - 47$ V	$V_{pos} - 47$ V	
Switching frequency for					
• Resistive loads max.	100 Hz	100 Hz	100 Hz	100 Hz	20 Hz
• Lamps max.	11 Hz	11 Hz	11 Hz	11 Hz	11 Hz
• Inductive loads max.	2 Hz (at 0.3 A) 0.5 Hz (at 0.5 A)	2 Hz (at 0.3 A) 0.5 Hz (at 0.5 A)	0.2 Hz (at 1 A) 0.5 Hz (at 2 A)	0.2 Hz (at 1 A) 0.5 Hz (at 2 A)	2 Hz
Total load rating <sup>3)</sup>					
• With fan	100 %	100 %	100 %	50 %	75 %
• Without fan	50 %	50 %	25 %	50 %	50 %
Leakage current at "0" sign. max.	0.5 mA	0.5 mA	1 mA	1 mA	5 mA
Signal level of the outputs					
• At "0" signal max.	+ 3 V	+ 3 V	+ 3 V	+ 3 V	0.1 $V_p$
• At "1" signal min. max.	$V_{pos} - 1.5$ V	$V_{pos} - 1.5$ V	$V_{pos} - 2.5$ V	$V_{pos} - 2$ V	$V_{pos} - 1.5$ V 300 m (984 ft)
Cable length (unshielded) max.	400 m (1312 ft)	400 m (1312 ft)	400 m (1312 ft)	400 m (1312 ft)	
<b>Enable input F</b>					Junper F+/F- in the front connector
Input voltage					
• Rated value	24 V DC	24 V DC	24 V DC	24 V DC	
• Enable	+ 13 ... + 33 V	+ 13 ... + 33 V	+ 13 ... + 33 V	+ 13 ... + 33 V	
• Disable	- 33 ... + 5 V	- 33 ... + 5 V	- 33 ... + 5 V	- 33 ... + 5 V	
Input current of enable input typ.	5 mA	5 mA	5 mA	5 mA	
Cable length (unshielded) max.	200 m (656 ft)	200 m (656 ft)	200 m (656 ft)	200 m (656 ft)	
<b>Signalling output H</b>					
Voltage if fault min.	$V_{pos} - 5$ V	$V_{pos} - 5$ V	$V_{pos} - 5$ V	$V_{pos} - 5$ V	
Current if fault (limited) max.	10 mA	10 mA	10 mA	10 mA	
Voltage if no fault max.	3 V	3 V	3 V	3 V	
Insulation voltage (external connections to housing)					
• In acc. with VDE 0160	—	75 V DC	75 V DC	75 V DC	250 V AC
• Tested with	—	1250 V AC	1250 V AC	1250 V AC	1500 V AC
Current consumption					
• Internal (at 5 V) typ.	80 mA	120 mA	120 mA	100 mA	100 mA
• External (at 24 V, no load) typ.	150 mA	150 mA	—	100 mA	—
Power loss max.	17.0 W	17.0 W	49.0 W	17.5 W	39.0 W
Space requirements	1 slot	1 slot	2 slots	1 slot <sup>5)</sup>	2 slots
Front connector	42-pin	42-pin	42-pin	25-pin/42-pin	20-pin
Weight approx.	0.45 kg (1 lb)	0.45 kg (1 lb)	0.6 kg (1.3 lb)	0.55 kg (1.2 lb)	0.7 kg (1.5 lb)

1) Can also be used as L- switch.

2) 1 input of a digital input module is permissible as the minimum load.

3) Referred to the sum of the rated currents through an L+ input.

4) A shielded signal lead is required for use of the module.

A filter (SIFI C, B84113-C-B-30 or equivalent) is required in the 24 V DC load power supply for the module.

5) Due to current load a double wide front connector is required.

## SIMATIC S5-135U, S5-155U/H

## Digital input/output modules

## Digital output modules (continued)

Technical data (continued)						
Digital output module	6ES5 456-4UA12 <sup>5)</sup>	6ES5 456-4UB12 <sup>5)</sup>	6ES5 457-4UA12 <sup>6)</sup>	6ES5 458-4UA12	6ES5 458-4UA12	
<b>Number of outputs</b>	<b>16</b>	<b>8</b>	<b>16</b>	<b>16</b> (relay contacts)	<b>16</b> (relay contacts)	
Galvanic isolation	yes	yes	yes	yes	yes	
• In groups of	8	1	1	1	8	
<b>Supply voltage</b> $V_p, V_{pos}$						
• Rated voltage	<b>115/230 V AC</b>	<b>115/230 V AC</b>	<b>24/48/60 V DC<sup>1)</sup></b>	<b>24 V DC</b>	<b>24 V DC</b>	
• Frequency	47 to 63 Hz	47 to 63 Hz	—	—	—	
• Ripple $V_{pp}$ (referred to rated voltage) max.	—	—	15 %	15 %	15 %	
• Permissible range (including ripple)	88 ... 264 V	88 ... 264 V	20 ... 72 V	20 ... 30 V	20 ... 30 V	
• Value at $t < 0.1$ s max.	—	—	90 V <sup>2)</sup>	35 V	35 V	
<b>Output current</b> at "1" signal						
• Rated value	<b>2 A</b>	<b>2 A</b>	<b>0.5 A</b>	—	—	
• Permissible range	0.04 ... 2 A	0.04 ... 2 A	5 mA ... 0.5 A	—	—	
• Making current per group for $t < 3 / < 20 / < 50$ ms max.	25/15/13 A	16/8/6.5 A	—	—	—	
Lamp load max.	100 W	100 W	5 W	—	—	
Short-circuit protection	Fuse (4x6.3 A)	Fuse (4x6.3 A)	Electronic	None	None	
Switch. cap. of the contacts max.	—	—	—	60V DC/48 V AC	110V DC/250 V AC	
• Resistive load						
With arc suppr. module max.	—	—	—	500 mA	5 A at 30 V DC , 5 A at 250 V DC	
Without arc suppr. module max.	—	—	—	70 mA <sup>4)</sup>	0.3 A at 115 V DC	
• Inductive load						
With arc suppr. module max.	—	—	—	50 mA <sup>4)</sup>	1.0 A at 30 V DC 1.5 A at 250 V AC	
Without arc suppr. module max.	—	—	—	—	0.08 A at 115 V DC	
Switch. cycl. (VDE 0660, Part 200)	—	—	—	$1 \cdot 10^8$	$3 \cdot 10^7$	
Limitation of the voltage induced on circuit interruption (internal) to	—	—	$V_{pos} - 75$ V	—	—	
Switching frequency for						
• Resistive loads max.	20 Hz	20 Hz	100 Hz	100 Hz	10 Hz	
• Lamps max.	11 Hz	11 Hz	11 Hz	11 Hz	5 Hz	
• Inductive loads max.	2 Hz	2 Hz	2 Hz (at 0.5 A)	2 Hz	2 Hz	
Total load rating <sup>3)</sup>						
• With fan	75 %	100 %	100 %	100 %	100 %	
• Without fan	70 %	50 %	50 % (100 % at 35 °C)	100 %	100 %	
Leakage current at "0" sign. max.	5 mA	5 mA	1 mA	—	—	
Signal level of the outputs						
• At "0" signal max.	0.1 $V_p$	0.1 $V_p$	+ 3 V	—	—	
• At "1" signal min.	—	—	$V_p - 2.5$ V	—	—	
max.	$V_p - 1.5$ V	$V_p - 1.5$ V	—	—	—	
Cable length (unshielded) max.	300 m (984 ft)	300 m (984 ft)	400 m (1312 ft)	400 m (1312 ft)	400 m (1312 ft)	
<b>Enable input F</b>	Jumper F+/F- in the front connector	Jumper F+/F- in the front connector				
Input voltage						
• Rated value			24/48/60 V DC	24/48/60 V DC	24 V DC	
• Enable			+ 13 ... + 72 V	- 13 ... + 33 V	+ 13 ... + 33 V	
• Disable			- 72 ... + 8 V	- 33 ... + 5 V	- 33 ... + 5 V	
Input current of enable input typ.			2.5 ... 6.5 mA	5 mA	5 mA	
Cable length (unshielded) max.			200 m ( 656 ft)	200 m (656 ft)	200 m (656 ft)	

1) Can also be used as L-switch.

2) For supply voltages higher than 72 V, the output voltage may exceed 13 V ("1" signal) in the non-drive state.

3) Referred to the sum of the rated currents through an L+ input.

4) Up to 500 mA possible with protective circuitry for the load (see operating instructions).

5) A filter (SIFI C, B84113-C-B-30 or equivalent) is required in the 230 V AC load power supply for the module.

6) A shielded signal lead is required for use of the module.

A filter (SIFI C, B84113-C-B-30 or equivalent) is required in the 24 V DC load power supply for the module.

## Digital output modules (continued)

Technical specifications (continued)		6ES5 456-4UA12 <sup>1)</sup>	6ES5 456-4UB12 <sup>1)</sup>	6ES5 457-4UA12 <sup>2)</sup>	6ES5 458-4UA12	6ES5 458-4UA12
<b>Digital output module</b>						
<b>Signal output H</b>						
Voltage if fault	min.			$V_{\text{pos}} - 5 \text{ V}$		
Current if fault (limited)	max.			10 mA		
Voltage if no fault	max.			3 V		
Insulation voltage (external connections to housing)						
• In acc. with VDE 0160		250 V AC	250 V AC	75 V DC	75 V DC	250 V AC
• Tested with		1500 V AC	1500 V AC	1250 V AC	500 V AC	1500 V AC
Current consumption						
• Internal (at 5 V)		100 mA	100 mA	120 mA	80 mA	120 mA
• External (at 24 V, no load)		—	—	—	200 mA	250 mA
Power loss	max.	39.0 W	18.0 W	13.0 W	5.2 W	6.6 W
Space requirements		2 slots	2 slots	2 slots	1 slot	1 slot
Front connector		20-pin	20-pin	42-pin	42-pin	42-pin
Weight	approx.	0.7 kg (1.5 lb)	0.6 kg (1.3 lb)	0.6 kg (1.3 lb)	0.45 kg (1 lb)	0.7 kg (1.5 lb)

1) A filter (SIFI C, B84113-C-B30 or equivalent) is required in the 230 V AC load power supply for the module.

2) A shielded signal lead is required for use of the module.

A filter (SIFI C, B84113-C-B30 or equivalent) is required in the 24 V DC load power supply for the module.

Ordering data	Order No.	Order No.
<b>Non-floating</b>		
<b>441-4 digital output module</b> 32 outputs, 24 V DC; 0.5 A	<b>6ES5 441-4UA14</b>	<b>458-4UA digital output module</b> 16 relay-contact outputs, 60 V; 0.5 V
<b>Floating</b>		
<b>451-4 digital output module</b> 32 outputs, 24 V DC; 0.5 A	<b>6ES5 451-4UA14</b>	<b>458-4UC digital output module</b> 16 relay-contact outputs, 110 V DC; 250 V AC; 5 A
<b>453-4 digital output module</b> 16 outputs, 24 V DC; 2 A (can also be used as L-switch)	<b>6ES5 453-4UA12</b>	<b>498 arc-suppression module</b> for the 458-4UA.. digital output module (RC elements for 4 outputs)
<b>454-4 digital output module</b> 16 outputs, 24 V DC; 2 A	<b>6ES5 454-4UA14</b>	The operating instructions are included in the S5-135U/155U system manual (see page 4/155).
<b>455-4 digital output module</b> 16 outputs, 24/48/60 V AC; 2 A	<b>6ES5 455-4UA12</b>	<b>497 front connector</b> Crimp terminals, single-width, 42-pin
<b>456-4UA digital output module</b> 16 outputs, 115/230 V AC; 2 A	<b>6ES5 456-4UA12</b>	Crimp terminals, double-width, 42-pin
<b>456-4UB digital output module</b> 8 outputs, 115/230 V AC; 2 A	<b>6ES5 456-4UB12</b>	Crimp terminals, double-width, 20-pin
<b>457-4 digital output module</b> 16 outputs, 24/48/60 V DC; 0.5 A (can also be used as L-switch)	<b>6ES5 457-4UA12</b>	Screw terminals, single width, 42-pin
		Screw terminals, double width, 42-pin
		Screw terminals, double width, 25-pin (454-4 only)
		Screw terminals, double width, 20-pin
		<b>6ES5 458-4UA12</b>
		<b>6ES5 458-4UC11</b>
		<b>6ES5 498-1AB11</b>
		<b>6ES5 497-4UA12</b>
		<b>6ES5 497-4UA22</b>
		<b>6ES5 497-4UA42</b>
		<b>6ES5 497-4UB31</b>
		<b>6ES5 497-4UB12</b>
		<b>6ES5 497-4UB22</b>
		<b>6ES5 497-4UB42</b>

# SIMATIC S5-135U, S5-155U/H

## Digital input/output modules

### Digital output modules (continued)

4

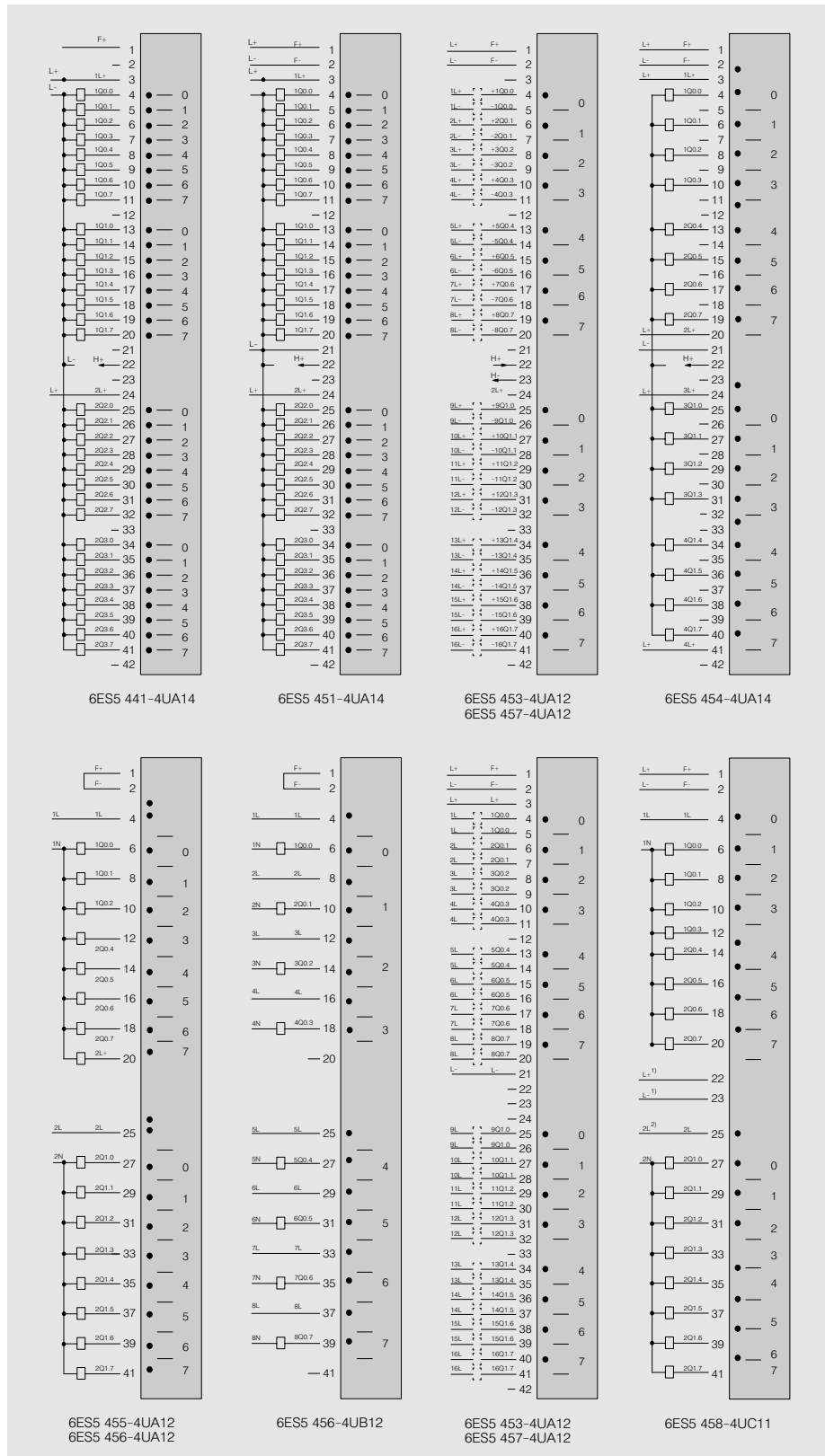

Fig. 4/24 Connection diagrams of digital output modules

- 1) 24 V DC supply voltage for the relays
- 2) Voltage for the relay contacts

## SIMATIC S5-135U, S5-155U/H

## Digital input/output modules

## Digital input/output module

## Application



The digital input/output module converts the external signals from the process to the internal signal levels of the programmable controllers and converts the internal signal levels of the programmable controllers to the levels required externally by the process.

4

## Design

The digital input/output module provides 16 binary inputs and eight binary outputs. Another eight terminals can be used either as inputs or outputs.

A shielded signal lead is required for use of the module.

## Technical specifications

<b>Number of inputs</b>	<b>16 or 24</b>	Enable input	Jumper F+/F- in the front connector
Galvanic isolation	Yes	Synchronization input	As for other binary inputs
• In groups of	16/24	Synchronization output and short-circuit signalling output	
<b>Input voltage</b>	<b>24 V DC</b>	• At "0" signal	max. +3 V
• Rated value	- 33 ... + 5 V	• At "1" signal	min. $V_{pos} - 5 V$
• For "0" signal	+ 13 ... + 33 V	(short-circuit)	max. 10 mA (current-limited)
• For "1" signal		• Output current	
Input current			
• At "1" signal	typ. 8.5 mA	<b>Supply voltage</b>	
Delay		(for load)	
• At "0" → "1"	typ. 0.3 ms	• Rated value	<b>24 V DC</b>
• At "1" → "0"	typ. 0.3 ms	• Ripple $V_{pp}$ (referred to rated voltage)	max. 15 %
Cable length		• Permissible range (including ripple)	20 ... 30 V
• Unshielded	max. 50 m (164 ft)	• Value at $t < 0.1$ s	max. 36 V
<b>Number of outputs</b>	<b>8 or 16</b>	Insulation voltage	
Galvanic isolation	Yes	(external connections to housing, internal connections, other groups)	
• In groups of	8/16	• In acc. with VDE 0160	75 V DC
<b>Output current at "1" signal</b>	<b>0.5 A</b>	• Tested at	1250 V AC
• Rated value	5 mA ... 0.5 A	Current consumption	
• Permissible range		• Internal (at 5 V)	typ. 90 mA
Lamp load	max. 5 W	• External (at 24 V, without load)	typ. 30 mA
Inductive load	max. 12 W	Power loss	max. 13 W
Short-circuit protection	Electronic	Space requirements	1 slot
Limitation of the voltage induced on circuit interruption (internal)	to - 27 V	Front connector	42-pin
Switching frequency for		Weight	approx. 0.4 kg (0.88 lb)
• Resistive loads	max. 100 Hz		
• Lamps	max. 11 Hz		
• Inductive loads	max. 2 Hz at 0.3 A, 0.5 Hz at 0.5 A		
Total load rating			
• With fan	100 %		
• Without fan	50 % (100 % at 35 °C)		
Leakage current at "0" signal	max. 0.5 mA		
Signal level of the outputs			
• At "0" signal	max. + 3 V		
• At "1" signal	min. $V_{pos} - 1.5 V$		
Cable length			
• Unshielded	max. 400 m (1312 ft)		



# SIMATIC S5-135U, S5-155U/H

## Digital input/output modules

### Digital input/output module (continued)

Ordering data	Order No.	Order No.
<b>482-4 digital input/output module</b> 16 or 24 inputs, 24 V DC and 8 or 16 outputs, 24 V DC; 0.5 A  The operating instructions are included in the S5-135U/155U system manual (see page 4/155).	<b>6ES5 482-4UA11</b>	<b>497 front connector</b> Crimp terminals, single-width, 42-pin Crimp terminals, double-width, 42-pin  Screw terminals, single-width, 42-pin Screw terminals, double-width, 42-pin
		<b>6ES5 497-4UA12</b> <b>6ES5 497-4UA22</b>  <b>6ES5 497-4UB31</b>  <b>6ES5 497-4UB12</b>

4

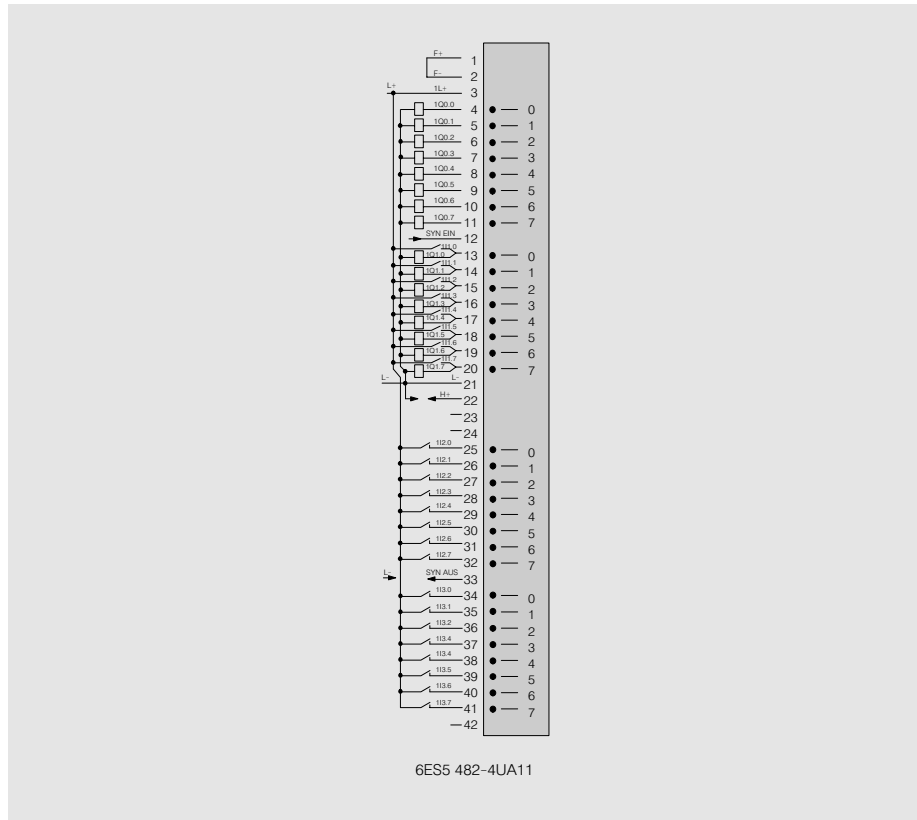

Fig. 4/25 Connection diagrams for the 482 digital input/output module

# SIMATIC S5-135U, S5-155U/H

## Analog input/output modules

### Overview

Analog input/output modules					
Input modules			Output modules		
Voltage values/ current values	Module ID	Page	Voltage values/ current values	Module ID	Page
±12.5 mV... 10 V	460-4	4/45	±10 V... or 0... 20 mA	470-UA	4/50
±20 mA or +4... 20 mA	465-4	4/45	±10 V	470-4UB	4/50
0... 1 V	463-4	4/45	±1... 5 V	470-4UC	4/50
0... 10 V			±4... 20 mA		
0... 20 mA or +4... 20 mA					
±1.25 V to ±10 V	466-3	4/45			
0... 1.25 V to 0... 10 V					
+1... 5 V					
0... 20 mA or 4... 20 mA					
±20 mA					

4

### Analog input modules

#### Application



The analog input modules convert the analog signals from the process into digital values, which can be processed by the programmable controller.

Application of analog input modules:

- Process monitoring
- Measuring physical quantities, e.g. in mechanical engineering, process engineering, building services automation
- Control engineering

#### Design

Analog input modules with 16, 8 and 4 inputs are available. The modules require one slot.

Front connectors are used for terminating the signal cables. Modules and front connectors may be inserted and removed under power (except for the 466 input module).

Adhesive labels are supplied to identify modules and front connectors.

460 input module:

- Eight floating channels
- Sequential measured value acquisition by means of optovoltalac multiplexer
- Measuring range selection by means of measuring range modules
- Direct acquisition of thermocouple voltages
- Direct four-wire connection of resistance-type sensors, e.g. Pt 100
- Power supply from L+, L-
- Use in large plants/machines with high common-mode voltages
- For closed-loop control applications with time constant ranging from seconds to infinity

463 input module:

- Four individually isolated channels
- Simultaneous scanning of all channels within  $16^{2/3}$  or 20 ms (50 or 60 Hz)
- Measuring range selection via jumpers in the front connector
- Acquisition of transducer signals
- For fast, noise-immune measured value acquisition even under unfavourable potential conditions
- For closed-loop control applications where speed is a critical factor (time constants >20 ms)

## SIMATIC S5-135U, S5-155U/H

## Analog input/output modules

## Analog input modules (continued)

## Design (continued)

465 input module:

- 16 non-floating channels
- Sequential measured value acquisition with semiconductor multiplexers
- Measuring range selection by means of measuring range modules
- Direct acquisition of thermocouple voltages
- Direct four-wire connection of resistance-type sensors, e.g. Pt 100
- Use in small-scale plants/machines where potential conditions are not a critical factor

Common features of the 460, 463 and 465 input modules:

- Integrating analog-digital conversion with a high degree of noise suppression at 50 (60) Hz and suppression of harmonics
- Enable input and input signals can be disabled
- The 460-4 input modules require two 498 measuring range modules
- The 465-4 input modules require two or four 498 measuring range modules, depending on whether up to 8 inputs or more than 8 inputs are used

466 input module:

- Eight differential or 16 individual channels (floating)
- Instantaneous value coding
- Measuring range selection through fixed wiring at the front connector
- For closed-loop control applications where speed is a critical factor (time constant >4 ms)

4

## Technical specifications

Analog input module	6ES5 460-4UA13	6ES5 465-4UA13 <sup>2)</sup>	6ES5 463-4U.12
<b>Number of inputs</b>	<b>8</b> voltage/current inputs or <b>8</b> inputs for Pt 100 resistance thermometers	<b>16</b> voltage/current inputs or <b>8</b> inputs for Pt 100 resistance thermometers	<b>4</b> voltage/current inputs
Galvanic isolation	Yes	No	Yes
<b>Input ranges</b> (rated value)	<b>± 12.5 mV</b> (for 460-4 only); <b>± 50 mV</b> ; <b>± 500 mV</b> ; <b>Pt 100</b> ; <b>± 1 V</b> ; <b>± 5 V</b> ; <b>± 10 V</b> ; <b>± 20 mA</b> ; <b>+ 4 ... 20 mA</b> Input range can be selected for 4 channels at a time, using measuring range modules		<b>0 ... 1 V</b> , <b>0 ... 10 V</b> , <b>0 ... 20 mA</b> <b>+ 4 ... 20 mA</b> for two-wire transducers and four-wire transducers
Input resistance in the individual ranges	12.5 mV: $\geq 10 \text{ M}\Omega$ Pt 100: $\geq 10 \text{ M}\Omega$ 50 mV: $\geq 10 \text{ M}\Omega$ 1 V: 90 k $\Omega$ ; 2 % 500 mV: $\geq 10 \text{ M}\Omega$ 5 V: 50 k $\Omega$ 2 %	10 V: 50 k $\Omega$ ; 2 % 20 mA: 25 k $\Omega$ ; 1 % 4 ... 20 mA: 31.25 $\Omega$ ; 1 %	1V: $\geq 10 \text{ M}\Omega$ ; 10 V: 90 k $\Omega$ ; 20 mA: 50 $\Omega$ 4 ... 20 mA: 62.5 $\Omega$ ;
Types of connection for signal sensors	Two-wire connection; four-wire connections for Pt 100		Two-wire connection
Digital representation of the input signal	12 bit plus sign or 13 bit two's complement (2048 units = rated value)		12 bit two's complement (1024 units = rated value)
Measuring principle	Integrating		Integrating
Conversion principle	Voltage-time conversion		Voltage-frequency conversion
Integration time (selectable for optimum noise suppression)	20 ms at 50 Hz 16 <sup>2</sup> / <sub>3</sub> ms at 60 Hz		20 ms at 50 Hz 16 <sup>2</sup> / <sub>3</sub> ms at 60 Hz
Encoding time per channel	60 ms at 50 Hz   based on rated value 50 ms at 60 Hz   based on rated value		20 ms at 50 Hz 16 <sup>2</sup> / <sub>3</sub> ms at 60 Hz
Cycle time for 4 inputs	—		20 ms at 50 Hz 16 <sup>2</sup> / <sub>3</sub> ms at 60 Hz
8 inputs	0.48 s at 50 Hz		—
16 inputs	—		—
Permissible voltage between inputs or between inputs and the central grounding point (destruction limit)	max. $\pm 18 \text{ V}$ or max. $\pm 75 \text{ V}$ for 1 ms with a pulse repeat rate of 50 pulses/second		max. $\pm 30 \text{ V}$ or $\pm 75 \text{ V}$ for 1 ms with a pulse repeat rate of 100 pulses/second
Permissible voltage between the reference potential of a non-floating sensor and the central grounding point	max. 75 V DC/60 V AC		max. 75 V DC/60 V AC

## Analog input modules (continued)

Technical specifications (continued)			
Analog input module	6ES5 460-4UA13	6ES5 465-4UA13 <sup>2)</sup>	6ES5 463-4U.12
Fault indication for	At 200 % of rated value (4095 units)		At 150 % of rated value
• Overranging	Can be designed for the range 50 mV, 500 mV and Pt 100		No
• Wire breakage of sensor line			No
Noise suppression for $f = n \cdot (50/60 \text{ Hz} \pm 1 \%)$ $n = 1, 2, \dots$			
• Common mode noise ( $V_p < 1 \text{ V}$ )	min. 100 dB	86 dB	80 dB
• Series mode noise (peak noise value < rated value of the range)	max. 40 dB	40 dB	40 dB
Basic error limits <sup>1)</sup> (at 20 °C)	12.5 mV: $\pm 2 \%$ 50 mV: $\pm 2 \%$ 500 mV: $\pm 1.5 \%$	Pt 100: $\pm 2 \%$ 1 V: $\pm 3.5 \%$ 5 V: $\pm 3.5 \%$	10 V: $\pm 3.5 \%$ 20 mA: $\pm 2.5 \%$ 4 ... 20 mA: $\pm 2.5 \%$
Operational error limits <sup>1)</sup> (at 0 °C to 60 °C; for one year)	12.5 mV: $\pm 6 \%$ 50 mV: $\pm 5 \%$ 500 mV: $\pm 4.5 \%$	Pt 100: $\pm 5 \%$ 1 V: $\pm 7.7 \%$ 5 V: $\pm 7.7 \%$	10 V: $\pm 7.7 \%$ 20 mA: $\pm 6.7 \%$ 4 ... 20 mA: $\pm 6.7 \%$
Cable length (shielded) max.	200 m (656 ft); 50 m (164 ft) up to 50 mV	200 m (656 ft); 50 m (164 ft) up to 50 mV	200 m (656 ft)
Enable inputs (as with analog outputs)	+ 24 V	+ 24 V	+ 24 V
Supply voltage (as with analog outputs)	+ 24 V	+ 24 V	+ 24 V
Constant current source for Pt 100	2.5 mA	2.5 mA	—
Current consumption			
• Internal (at 5 V) typ.	0.13 A	0.15 A	0.2 A
• External (at 24 V) typ.	0.15 A	0.15 A	0.15 A
Power loss max.	3.5 W	1.5 W	5.0 W
Space requirements	1 slot		1 slot
Front connector	42-pin		42-pin
Weight approx.	0.4 kg (0.88 lb)		0.4 kg (0.88 lb)
Analog input module	6ES5 466-3LA11		
Number of inputs	8 differential inputs or 16 individual inputs (referred to ground) in 4 or 2 groups (selectable)		
Galvanic isolation	Yes		
Input ranges (rated values)	0 ... 20 mA; 4 ... 20mA; $\pm 20 \text{ mA}$ } Selector switch lets you select 0 ... 1.25 V; 0 ... 2.5 V; 0 ... 5 V; 1 ... 5 V; 0 ... 10V } these values for 4 channels $\pm 1.25 \text{ V}$ ; $\pm 2.5 \text{ V}$ ; $\pm 5 \text{ V}$ ; $\pm 10 \text{ V}$ ; } separately		
Input resistance in the individual ranges	Voltage measuring range: $\geq 10 \text{ M}\Omega$ Current measuring range: $125 \Omega$		
Types of conn. for signal sensors	Two-wire connection		
Digital repres. of the input signal	13 bit two's complement or 12 bit abs. value + sign or 12 bit binary		
Measuring principle	Instantaneous value encoding		
Conversion principle	Successive approximation		
Encoding time per channel max.	250 $\mu\text{s}$		
Cycle time for			
• 8 inputs max.	2 ms		
• 16 inputs max.	4 ms		
Permissible voltage between inputs or between inputs and central grounding point max.	$\pm 30 \text{ V}$ (static) or $\pm 75 \text{ V}$ for 1 ms with a pulse repeat rate of 50 pulses/second		
Permissible voltage between the reference potential of a non-floating sensor and the central grounding point max.	75 V DC/60 V AC		

1) In accordance with DIN 43 745; referred to nominal measuring range (5 V supply from power supply chassis).

2) A filter (SIFI C, B84113-C-B30 or equivalent) is required in the 24 V DC load power supply for the module.

## SIMATIC S5-135U, S5-155U/H

## Analog input/output modules

## Analog input modules (continued)

## Technical specifications (continued)

Analog input module		6ES5 466-3LA11 (continued)	
Fault indication for			
• Overranging		Yes (overflow bit)	
• Wire breakage of sensor line		No	
Noise suppression for $f = n \cdot (50/60 \text{ Hz} \pm 1 \%)$ ; $n = 1, 2 \dots$			
• Common mode noise ( $V_p < 1 \text{ V}$ )min		70 dB	
• Series mode noise (peak noise value < value of the range)	min.	40 dB	
Basic error limits <sup>1)</sup> (at 20 °C)		Voltage ranges (except 0 ... 1.25 V; $\pm 1.25 \text{ V}$ ):	0.1 %
		Current ranges and 0 ... 1.25 V; $\pm 1.25 \text{ V}$ :	0.2 %
Operational error limits <sup>1)</sup> (at 0 to 60 °C; for one year)		Voltage ranges (except 0 ... 1.25 V; $\pm 1.25 \text{ V}$ ):	0.2 %
		Current ranges and 0 ... 1.25 V; $\pm 1.25 \text{ V}$ :	0.4 %
Cable length (shielded)	max.	200 m (656 ft)	
Enable inputs (as with analog outputs)		—	
Supply voltage (as with analog outputs)		—	
Constant current source for Pt 100		—	
Current consumption			
• Internal (at 5 V)	typ.	0.7 A	
• External (at 24 V)	typ.	—	
Power loss	max.	3.5 W	
Space requirements		1 slot	
Front connector		43-pin	
Weight	approx.	0.4 kg (0.88 lb)	

1) In accordance with DIN 43 745; referred to nominal measuring range (5 V supply from power supply chassis).

Ordering data	Order No.	Ordering data	Order No.
<b>460-4 analog input module</b> 8 inputs, signal range set via measuring range module (two 498 measuring range modules are required); floating	<b>6ES5 460-4UA13</b>	<b>463-4 analog input module</b> 4 inputs, floating For 50 Hz power systems For 60 Hz power systems	<b>6ES5 463-4UA12</b> <b>6ES5 463-4UB12</b>
<b>465-4 analog input module</b> 16 inputs (8 with Pt 100), signal range set via measuring range module (two or four 498 measuring range modules are required); non-floating	<b>6ES5 465-4UA13</b>	<b>466-3 analog input module</b> 16 inputs, floating The operating instructions are included in the S5-135U/155U system manual (see page 4/155).	<b>6ES5 466-3LA11</b>
<b>498 measuring range module</b> for 460-4 and 465-4 analog input modules; four channels each $\pm 12.5 \text{ mV}$ , $\pm 50 \text{ mV}$ , $\pm 500 \text{ mV}$ , Pt100 $\pm 1 \text{ V}$ $\pm 5 \text{ V}$ $\pm 10 \text{ V}$ $\pm 20 \text{ V}$ + 4 ... 20 mA; for two-wire transducer + 4 ... 20 mA; for four-wire transducer	<b>6ES5 498-1AA11</b> <b>6ES5 498-1AA21</b> <b>6ES5 498-1AA61</b> <b>6ES5 498-1AA31</b> <b>6ES5 498-1AA41</b> <b>6ES5 498-1AA51</b>  <b>6ES5 498-1AA71</b>	<b>497 front connector</b> for 460, 463, 465 analog input modules Crimp terminals, single-width, 42-pin Crimp terminals, double-width, 42-pin Screw terminals, single-width, 42-pin Screw terminals, double-width, 42-pin <b>Front connector</b> for 466 analog input module Crimp terminals, single-width, 43-pin Screw terminals, single-width, 43-pin	<b>6ES5 497-4UA12</b> <b>6ES5 497-4UA22</b> <b>6ES5 497-4UB31</b> <b>6ES5 497-4UB12</b>  <b>6XX3 068</b> <b>6XX3 081</b>

# SIMATIC S5-135U, S5-155U/H

## Analog input/output modules

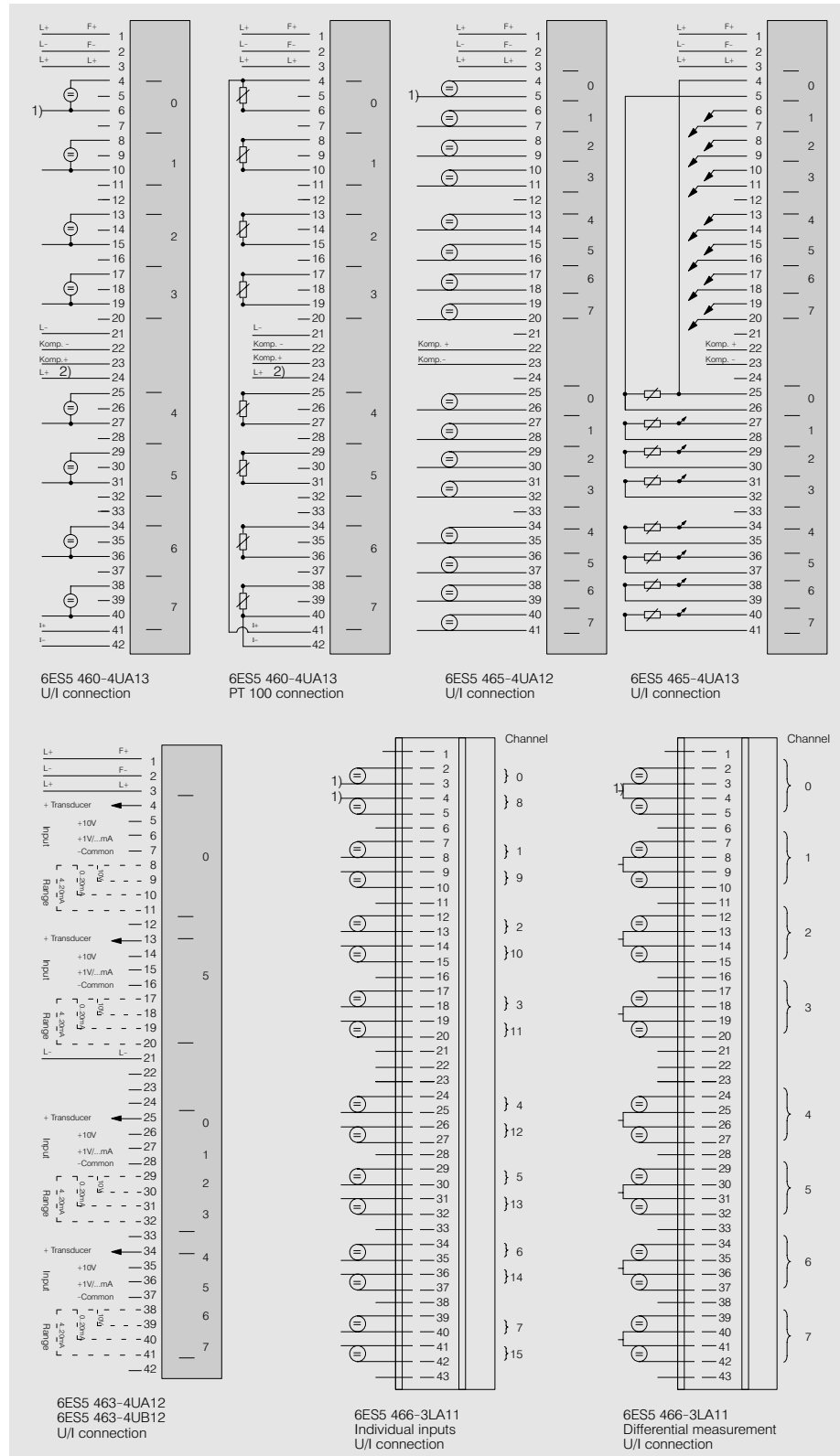

Fig. 4/26 Connection diagrams for analog input modules

- 1) Connection to the central grounding point of the system (see under technical specifications)
- 2) Only for disconnecting the test current if wire breakage monitoring is not activated

## SIMATIC S5-135U, S5-155U/H

## Analog input/output modules

## Analog output modules

## Application



The analog output modules convert the digital values from the programmable controller into analog signals required by the process.

4

## Design

Three analog output modules are available with eight outputs each and a range of output voltages. The modules require one slot.

Front connectors are used for terminating the signal cables. Modules and front connectors may be inserted and removed under power.

Adhesive labels are supplied for identifying modules and front connectors.

## Principle of operation

## Enable input

The enable input can be used to disable the output of new

values. The last output value is retained. The enable input can be deactivated by

removing the respective jumper on the module.

## Technical specifications

<b>Number of outputs</b>	<b>8</b> voltage and current outputs		
Galvanic isolation	Yes (not between the outputs)		
<b>Output ranges</b> (rated values)	<b>± 10 V; 0 ... 20 mA</b>		
• 6ES5 470-4UA12	<b>± 10 V</b>		
• 6ES5 470-4UB12	<b>+ 1 ... 5 V; + 4 ... 20mA</b>		
• 6ES5 470-4UC12			
Load resistance	Purely ohmic		
• For voltage outputs	min.	3.3 kΩ	
• For current outputs	max.	300 Ω	
Load connection	To the M <sub>analog</sub> terminal		
Digital representation of the output signal	12 bit two's complement (1024 units = rated value)		
Permissible overload capability	approx.	25 % (up to 1280 units)	
Conversion time	1 ms		
Short-circuit protection	Yes		
Short-circuit current	approx.	25 mA (for a voltage output)	
Open-circuit voltage	max.	18 V (for a current output)	
Voltage between the reference potential of the load (M <sub>analog</sub> connection) and the casing	max.	60 V AC/75 V DC	
Basic error limits <sup>1)</sup> (at 20 °C)	± 2 ‰ ± 2 units		
Operational error limits (0 to 60 °C; for one year)	± 6 ‰		
Cable length (shielded)	max.	200 m (656 ft)	
<b>Enable input F</b>			
Input voltage			24 V DC
• Rated value			+ 13 ... 33 V
• Enable			- 33 ... + 5 V
• Disable			
Input current (for enable)	typ.	typ.	5 mA
Cable length (unshielded)	max.	max.	200 m (656 ft)
<b>Supply voltage V<sub>pos</sub></b>			
• Rated value			24 V DC
• Ripple V <sub>pp</sub> (referred to rated voltage)			15 %
• Permissible range (including ripple)			20 ... 30 V
• Value at t < 0.1 s	max.	max.	36 V
<b>Current consumption</b>			
• Internal (at 5 V)	typ.	typ.	0.25 A
• External (at 24 V)	typ.	typ.	0.3 A
Space requirements			1 slot
Power loss	max.	max.	9.0 W
Front connector			42-pin
Weight	approx.	approx.	0.4 kg (0.88 lb)

1) In accordance with DIN 43 745; referred to nominal measuring range (5 V supply from power supply chassis)

2) A filter (SIFI C, B84113-C-B30 or equivalent) is required in the 24 V DC load power supply for the module.

## SIMATIC S5-135U, S5-155U/H

## Analog input/output modules

## Analog output modules (continued)

Ordering data	Order No.	Order No.
<b>470-4UA analog output module</b> 8 outputs, $\pm 10$ V, 0 ... 20 mA; floating	<b>6ES5 470-4UA13</b>	<b>497 front connector</b> Crimp terminals, single-width, 42-pin
<b>470-4UB analog output module<sup>2)</sup></b> 8 outputs, $\pm 10$ V, floating	<b>6ES5 470-4UB13</b>	Crimp terminals, double-width, 42-pin
<b>470-4UC analog output module</b> 8 outputs, + 1 ... 5 V, + 4 ... 20 mA; floating	<b>6ES5 470-4UC13</b>	Screw terminals, single-width, 42-pin
The operating instructions are included in the S5-135U/155U system manual (see page 4/155).		Screw terminals, double-width, 42-pin
		<b>6ES5 497-4UA12</b>
		<b>6ES5 497-4UA22</b>
		<b>6ES5 497-4UB31</b>
		<b>6ES5 497-4UB12</b>

4

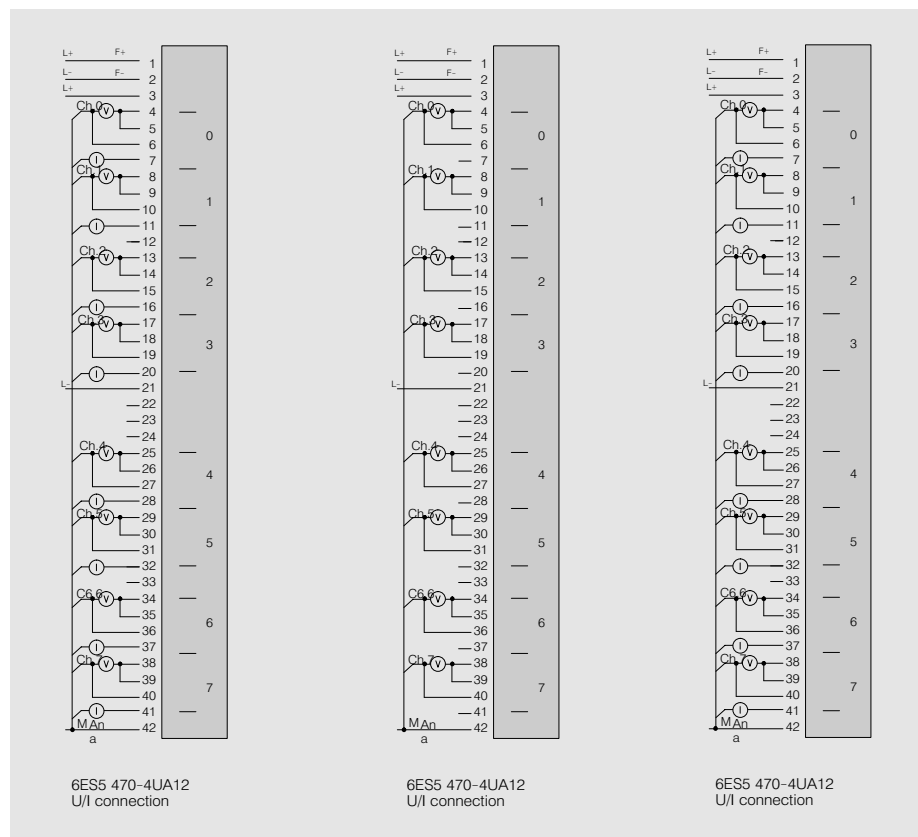

Fig. 4/27 Connection diagrams for analog output modules



# SIMATIC S5-135U, S5-155U/H

## Intelligent I/O modules

### Overview

#### Application

Intelligent I/O modules are used for high-speed, high accuracy

- Closed-loop control
- Positioning
- Counting and proportioning

The advantage of the intelligent I/O modules lies in the

fact that they execute these time-critical tasks completely autonomously. The CPU can then concentrate on its own control tasks more closely.

There is an entire range of intelligent I/O modules for the S5-135U and S5-155U/H

programmable controllers, which can be used for various applications.

The following overview shows which modules can be used for which applications.

### Signal preprocessing

Closed-loop control	Page	Positioning Open-loop control	Page	Positioning Closed-loop control	Page	Counting/ proportioning	Page	Signal processing	Page
<ul style="list-style-type: none"> <li>• IP 244 temperature</li> <li>• IP 252 closed-loop control module for drives</li> <li>• IP 260 closed-loop control module for high-speed individual controllers</li> </ul>	4/61 4/71 4/74	<ul style="list-style-type: none"> <li>• IP 240 counter/position decoder/positioning module</li> <li>• IP 241 digital position decoder</li> <li>• IP 247 positioning module for stepper motors</li> <li>• WF 705 position encoder module</li> <li>• WF 706C positioning module</li> <li>• WF 707 cam controller</li> </ul>	4/53 4/55 4/69 4/81 4/83 4/86	<ul style="list-style-type: none"> <li>• IP 246I and IP 246A positioning module for servo drives</li> <li>• WF 721, WF 723A, WF 723B and WF 723C positioning modules</li> </ul>	4/65 4/89	<ul style="list-style-type: none"> <li>• IP 240 counter/position decoder/positioning module</li> <li>• IP 242A, IP 242B counter modules</li> <li>• IP 261 proportioning module</li> <li>• IP 281 counter module</li> </ul>	4/53 4/57 4/77 4/79	<ul style="list-style-type: none"> <li>• IP 243 analog module</li> </ul>	4/53

- Page 4/84: Comparison of IP 240 and IP 288 with WF 706
- Page 4/87: Comparison of IP 241 and IP 288 with WF 707
- Page 4/90: Comparison of IP 246 with WF 721 and WF 723A

# SIMATIC S5-135U, S5-155U/H

## Intelligent I/O modules

### IP 240 counter, position decoder and positioning module

#### Application



The IP 240 counter, position decoder and positioning module is used for acquiring and preprocessing pulse trains for counting, position

decoding, positioning and speed measurement with the IP 252 closed-loop control module (with incremental pulse generator).

The combination with IP 252 is only possible in the S5-115U.

4

#### Design

The module contains two channels that can be used independently of each other in four modes:

- Counting (signals from pulse encoders at frequencies of up to 70 kHz)
- Position decoding (in conjunction with incremental position encoders)
- Positioning via cut-off points
- Speed measurement for the IP 252 closed-loop control-module (in conjunction with

incremental speed encoders)

Besides the inputs for pulse sensing (inputs for 5 V and 24 V available), each channel of the module is provided with:

- 1 enable input (5 V/24 V) for "counting" mode
- 1 reference input (preliminary contact, 5 V/24 V) for position decoding and positioning
- 2 outputs (5 V/24 V; 0.5 A) for control of actuators

The cables to the sensors can be connected

- either with 15-pin sub D connectors (upper sockets, shielded cables) or with
- screw-type connectors (lower sockets, cables up to 1.5 mm<sup>2</sup>, up to approx. 10 kHz)

The module requires one slot.

#### Principle of operation

##### Counting

The positive-going edge of the enable input sets the counter to the initial value set in the user program (max. 9999). The counter counts the input pulses down to zero. When 0 is reached, the counter generates a process interrupt or sets its output (program-selectable). The pulses continue to be counted (down to max. -9999) if the enable input remains "1".

##### Position decoding

The counter counts up and down to  $\pm 99,999$ . The counting pulse frequency can be doubled or quadrupled via user program. The channel is synchronized via the reference input.

Eight tracks (cams; travel sections or counting ranges; with allowance for a zero offset) can be specified via software.

##### Positioning via cut-off points

In this mode, defined points within the traverse range ( $\pm 9,999,999$ ) of the axis can be approached.

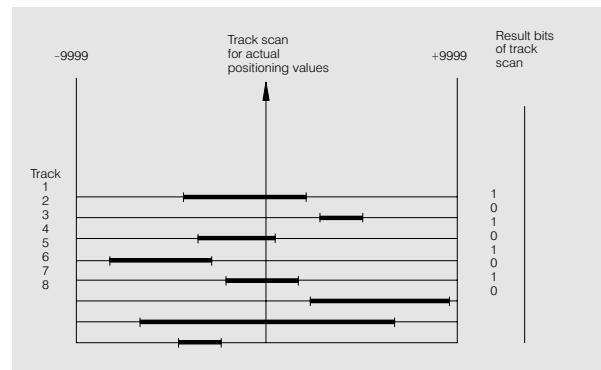

Fig. 4/29 Timing diagram for a positioning decoder

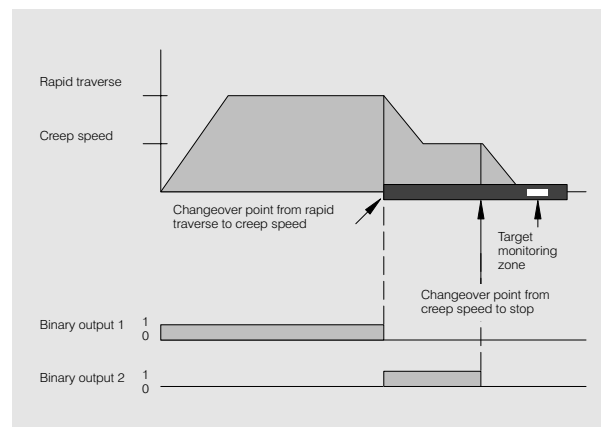

Fig. 4/30 Positioning of a pole-changing motor

## SIMATIC S5-135U, S5-155U/H

## Intelligent I/O modules

## IP 240 counter, position decoder and positioning module (continued)

Principle of operation  
(continued)

The drives used are driven direct. Up to 254 positions per channel can be stored in the module. The positions lie within three zones, which represent the cut-off points and the target range.

Synchronization is implemented via:

- Reference point approach
- Software synchronization

- Cyclic synchronization at the positive-going edge of the signal

A rotary or linear axis function can be programmed.

The actual value can be offset through relative and additive zero offset.

The positioning tolerance varies between

$\pm 0.002$  mm at 0.06 m/min and  $\pm 2$  mm at 60 m/min.

The following errors are detected:

- Wire breakage with 5V symmetrical position encoders
- Short-circuit in signal cables
- Zero mark errors

The necessary program for the CPU is available in the form of standard function blocks (see Section 7).

4

## Technical specifications

Pulse inputs		Binary outputs	
Galvanic isolation	No	Number per channel	2 with position decoding and positioning, 1 with counting
Position decoding, positioning		Galvanic isolation	Yes
• Differential inputs (5 V, symmetr.) for sensor interfaces to RS 422A or similar	2 pulses displaced by 90° and zero mark and inverse signals (e.g. Siemens 6FX2 001-2... positioning encoder)	Supply voltage $V_{pos}$ (for load)	
Input frequency	max. 500 kHz	• Rated value	24 V DC
Cable length (shielded)	max. 30 m (98.4 ft) (w/ 5 V sensor sply)	• Ripple $V_{pp}$	max. 3 V
• 5V/24V inputs (asymmetrical)	2 pulses displaced by 90° and zero mark (e.g. Siemens 6FX2 001-4... posn. encoder)	• Permissible range (including ripple)	20 ... 30 V
Input frequency	max. 50 kHz	Output current at "1" signal	
Cable length (shielded)	max. 25 m (82 ft) 100 m (328 ft)	• Rated value	500 mA
Counting		Switching frequency with	
5V/24V inputs	Pulses	• Resistive load (24 V, 50 mA)	max. 200 Hz
Input frequency	max. 70 kHz 25 kHz	• Inductive load (8.5 W)	max. 2 Hz
Cable length (shielded)	max. 25 m (82 ft) 100 m (328 ft)	• Lamp load (5 W)	max. 8 Hz
Input voltage		Residual load at "0" signal	max. 1 mA
• Rated value	5 V DC 24 V DC	Output voltage	
• For "0" signal	0 ... 0.8 V - 30 ... + 5 V	• At "1" signal	min. $V_{pos} - 3$ V
• For "1" signal	+ 2.4 ... 5 V + 13 ... 30 V	Cable length	
Input current at "1" signal	typ. 0.14 mA 6.5 mA	• Shielded	max. 1000 m (3280 ft)
<b>Binary inputs</b>		Current consumption	
Galvanic isolation	No No	• Internal (at 5 V)	typ. 0.8 A (excluding sensor supply)
Input voltage		Supply current for sensors	
• Rated value	5 V DC 24 V DC	• At 5 V	max. 0.8 A total
• For "0" signal	0 ... 0.8 V - 30 ... + 5 V	• At 24 V	max. 0.6 A total
• For "1" signal	+ 2.4 ... 5 V + 13 ... 30 V	(external supply)	max.
Input current at "1" signal	max. 0.14 mA 6.5 mA	Addresses used	16 byte
Cable length (shielded)	max. 100 m (328 ft) 100 m (328 ft)	Space requirements	1 slot
		Weight	approx. 0.45 kg (0.99 lb)

## Ordering data

Order No.	Order No.
<b>IP 240 counter, position decoder and positioning module</b> To be ordered as a separate item: <b>Configuring package for IP 240</b> comprising manual and standard FB <sup>1)</sup> for counting, position acquisition and positioning German English French Italian	<b>705-3 connecting cables</b> for Siemens positioning encoder 6FX 2001-2 with $V_{pos} = 5$ V 5 m (16.4 ft) 10 m (32.8 ft) 20 m (65.6 ft) 32 m (104.9 ft)
<b>6ES5 240-1AA21</b>  <b>6ES5 240-5AA11</b> <b>6ES5 240-5AA21</b> <b>6ES5 240-5AA31</b> <b>6ES5 240-5AA51</b>	<b>6ES5 705-3 BF01</b> <b>6ES5 705-3 CB01</b> <b>6ES5 705-3 CC01</b> <b>6ES5 705-3 CD21</b>  <b>6ES5 750-2AA21</b>
	<b>Sub D connector</b> 15-pin

1) For description see Page 7/109

# SIMATIC S5-135U, S5-155U/H

## Intelligent I/O modules

### IP 242A and IP 242B counter modules

#### Application



The IP 242A and IP 242B counter modules are used for acquiring and processing counting pulses up to a frequency of 500 kHz. They are suitable for pulse counting, frequency generation and division, and for measuring frequency, time and speed.

The IP 242B counter module is designed for applications

where the result needs to be processed extremely quickly. It has a large number of arithmetic functions and an integral measured value memory, which reduces the dependency on the access time of the CPU and it can therefore pass on the count values to the CPU ready processed.

4

#### Design

The IP 242A and IP 242B counter modules contain a total of seven independent 16-bit or 32-bit counter channels. Five of these channels can be used for counting up and down. The inputs and outputs are galvanically isolated. The IP 242A can be upgraded to an IP 242B with an EPROM and operated when the standard function blocks have been replaced.

The modules each require one slot.

#### Features

- Counting frequency up to 500 kHz;
- Scaler chain (programmable and assigned randomly to counters 1 to 5), 4 x part factor 10 or 16 (BCD) and 1 x 4 bit
- Counters 1 to 5 cascadable
- Group interrupt output for user program

- 19 modes of operation for counters 1 to 5
- 1/3 modes of operation for counters 6 and 7
- Input signal level 5 V or 24 V, with 16-bit counters, adaptation for each individual input by jumpers or resistors
- Output signal (24 V level) with up to 40 kHz pulse or varied pulse and pulse pause

#### Principle of operation

The counting and gate pulses of the individual counter channels can be derived from an external pulse encoder or from an internal quartz crystal. The counter outputs can be configured as either pulse outputs or level switch outputs.

An interrupt can be issued when a predefined interrupt value or the synchronization point is reached. The response times can be reduced considerably by instruction lists (short user programs) on the counter modules.

If the counting range of one counter is not sufficient, several counters can be cascaded together.

The necessary software for the CPU is available in the form of standard function blocks (see Section 7).

#### Technical specifications

Counter module	IP 242A	IP 242B
Number of counters		
• With 16 bit (cascadable) (counters 1 to 5)	5 (up/down programmable)	—
• With 24 bit (counters 6 and 7)	2 up and down for direct connection of incremental encoders with two pulse trains displaced by 90° (5 V, RS 422)	—
• With 32 bit (counters 6 and 7)	—	2 up and down for direct connection of incremental encoders with two pulse trains displaced by 90° (5 V, RS 422)
Number of modes (software-selectable)	19 (counters 1 to 5) 1 (counters 6 and 7)	19 (counters 1 to 5) 3 (counters 6 and 7)
Number of counters with comparison facility for random counts	7	7
Clock frequency (internal)	(one interrupt value can be specified for each counter)	(one interrupt value can be specified for each counter)
• Counters 1 to 5	1 MHz with 16-bit scaler as well as programmable scaler chain	1 MHz with 16-bit scaler as well as programmable scaler chain
• Counters 6 and 7	—	10 MHz (direct, without scaler)
Counter frequency conditioning	Yes, for counters 1 to 5	Yes, for counters 1 to 5
Counting frequency		
• 24 V signals/		
5 V signals/	480 kHz (counters 1 to 5)	480 kHz (counters 1 to 5)
• 5 V (RS 422)	500 kHz (counters 6 and 7)	500 kHz (counters 6 and 7)
Measured value preprocessing	No	Yes, by means of arithmetic functions
Measured value memory	No	Yes, freely assignable up to 100 measured values (100 x 2 data words)

## SIMATIC S5-135U, S5-155U/H

## Intelligent I/O modules

## IP 242A and IP 242B counter modules (continued)

## Technical specifications (continued)

Counter module	IP 242A	IP 242B
Galvanic isolation (for inputs and outputs)	Yes, but not for incremental encoder inputs 6 and 7	
Power supply voltage $V_{pos}$		
• Rated value	24 V DC	
• Ripple $V_{pp}$ max.	3.6 V	
• Permissible range (including ripple)	20 ... 30 V	
• Value at $t < 0.5$ s max.	35 V	
Input voltage (counters 1 to 5)	The counters can also be set to 24 V or 5 V signal levels by jumpers (one per input)	
• Rated value	24 V DC	
• For "0" signal	- 35 ... + 4.5 V	
• For "1" signal	+ 13 ... + 33 V	
• Rated value	5 V DC	
• For "0" signal	- 3 ... + 1.5 V	
• For "1" signal	+ 4 ... + 6.5 V	
Input voltage (counters 6 and 7)	5 V (RS 422)	
Input voltage at "1" signal typ.	13 mA (at 24 V), 12 mA (at 5 V)	
Output voltage		
• Rated value	24 V DC	
• At "0" signal max.	+ 3 V	
• At "1" signal min.	$V_{pos} - 2.5$ V	
Output current at "1" signal		
• Rated value	200 mA	
• Permissible range	0.2 ... 100 mA	
Output frequency max.	40 kHz	
Residual current at "0" signal max.	100 $\mu$ A	
Short-circuit protection	Electronic	
Insulation voltage rating		
External connections to housing		
• In acc. with VDE 0160	75 V DC	
• Tested with	500 V AC	
Current consumption		
• Internal (at 5 V)	1.1 A	
• External (at 24 V, no load)	50 mA	
Assigned binary addresses	1 Kbyte with S5-155U, page addressing optional, 1 page frame	Page addressing, 1 page frame
Space requirements	1 slot	
Weight approx.	0.4 kg (0.9 lb)	

## Ordering data

	Order No.		Order No.	
<b>IP 242A counter module<sup>2)</sup></b>	<b>6ES5 242-1AA32</b>	<b>Connector</b> (4 pcs.)	<b>6ES5 983-2AB11</b>	
<b>Upgrade kit</b> from IP 242A and IP 242B	on request			
<b>IP 242B counter module</b>	<b>6ES5 242-1AA41</b>	<b>Converter</b> for 24 V asymmetrical incremental encoder up to 5 V (RS 422) - symmetrical incremental encoder	<b>6ES5 242-1AU11</b>	
To be ordered as a separate item:				
<b>Configuring package for IP 242A/B</b> comprising manual and standard FB <sup>1)</sup>		<b>705 connecting cable</b> for connection of Siemens position encoder 6FX2 001-2...	<b>6ES5 705-2BF00</b> <b>6ES5 705-2CB00</b> <b>6ES5 705-2CC00</b>	
German	<b>6ES5 242-5AB11</b>			Length 5 m (16.4 ft)
English	<b>6ES5 242-5AB21</b>			10 m (32.8 ft)
French	<b>6ES5 242-5AB31</b>			20 m (65.6 ft)
Italian	<b>6ES5 242-5AB51</b>			

1) For description see Page 7/121

2) Cannot be used with CPU 945

# SIMATIC S5-135U, S5-155U/H

## Intelligent I/O modules

### IP 243-3 analog module

#### Application



The analog module IP 243-3 allows the input, output, pre-processing and routing of analog signals with a short processing time.

4

#### Design

The module contains the following components:

- 1 analog/digital converter (-10 to +10V, 12 bits, 35 s) with 8 inputs
- 2 digital/analog converters (-10 to +10V, 12 bit, 5 s)
- 1 digital/analog converter (0 to +10V, 8 bit, 10 s)
- 4 analog value matching functions (zero offsets and amplifier settings)
- 2 difference amplifiers (P controllers) with settable gain
- 2 analog value comparators, the results are read in via a following logical circuit and then further processed as alarms (depending on the type of programmable controller used via alarm cables or via a digital input module with alarm generation)
- 1 digital output (8 outputs, 24 V; 0.4 A)
- 1 digital input (8 inputs, 24 V)

The gains and zero points can be set on the front panel via trim pots. 6 measuring sockets are available for checking the settings.

The module requires 1 slot.

#### Principle of operation

Depending on the given task, the components can be connected to each other or to the inputs and outputs (routing).

The analog values of an input selected via the multiplexer are converted to digital values via the A/D converter so that they can then be processed directly in the central controller.

At the same time they can be compared with other values in the IP 243-3. Individual analog values can be adapted for this. Set values for direct comparison can be sent from the central controller to the IP 243-3 through the D/A converter.

The program required for the central controller is available as standard function modules (see Catalog Section 7).

#### Technical specifications

##### A/D converter, 12 bit

Number of inputs	<b>1</b>
Input voltage range (set with jumpers)	<b>8</b>
Input resistance approx.	-5 to +5 V, -10 to +10 V, 0 to 10 V
Digital representation of signal	1 MΩ
Conversion method	11 bit + sign; input voltage range = 2047 units
Conversion time max. (without command processing times)	successive approximation
Basic error limits	35 μs
Operational error limits	± 0.6 ‰
	± 1.2 ‰ (0 to 55 °C)

##### D/A converter, 12 bit

Output voltage	<b>2</b>
Load impedance min.	-10 to +10 V
Digital representation of signal	2 kΩ
Short-circuit protection	11 bit + sign; output voltage range = 2047 units
Short-circuit current approx.	yes
Settling time to 99% of final value for 20 m line length	25 mA
Basic error limits	5 μs
Operational error limits	± 0.6 ‰
	± 0.9 ‰ (0 to 55 °C)

## SIMATIC S5-135U, S5-155U/H

## Intelligent I/O modules

## IP 243-3 analog module (continued)

## Technical specifications (continued)

<b>D/A converter, 8 bit</b> (with amplifier)	<b>1</b>	<b>Binary outputs</b>	<b>8</b>
Output voltage range	0 to 10 V	Output voltage range	24 V DC
Load impedance min.	2 k $\Omega$	• nominal value	3 V
Digital representation of signal	8 bit; output voltage range = 255 units	• for signal „0” max.	$U_p - 1.9 V$
Short-circuit protection	yes	• for signal „1” min.	
Short-circuit current approx.	50 mA	Output current for signal "1"	200 mA
Settling time to 99% of final value for 20 m line length	10 $\mu$ s	• nominal value	2 to 200 mA
Basic error limits	$\pm 2\%$	• permissible range	Fuse
Operational error limits	$\pm 4\%$ (0 to 55 °C)	Short-circuit protection	
<b>Analog value matching</b>	<b>4</b>	Limitation of inductive switch-off voltage to auf	-2 V
Input voltage range	-4 to +10 V	Operating frequency with ohmic load max.	1 kHz
Input resistance approx.	200 k $\Omega$	Total load capability at 55 °C (with ref. to the sum of the nomi- nal currents of all outputs)	37 %
Input filter time constant approx.	0.1 ms	Residual current at signal "0"	250 $\mu$ A
Gain range	0.5 to 5	<b>General data</b>	
Setting range for zero offset	-2 to +2 V	Supply voltage $V_p$	24 V DC
<b>Difference amplifier</b>	<b>2</b>	• nominal value	3.6 V
Input voltage range	-10 to +10 V	• ripple $V_{pp}$	20 to 30 V
Input resistance approx.	1 M $\Omega$	• permissible range (incl. ripple)	35 V
Input filter time constant approx.	0.5 ms	• value at $t < 0.5$ s	
Gain range	1.1 to 20	Current consumption	
Output voltage range	-10 to 10 V	• internal (at 5 V)	600 mA
Load impedance min.	2 k $\Omega$	• external (at 24 V, no load)	270 mA
Short-circuit protection	yes	Galvanic isolation	No
Short-circuit current approx.	50 mA	Cable length	
<b>Comparator</b>	<b>2</b>	• for analog signals, shielded	20 m
Number of inputs	2	• for binary signals	400 m
Input voltage range	0 to +10 V	unshielded	1000 m
Input resistance approx.	44 k $\Omega$	shielded	
Input filter time constant approx.	0.25 ms	Reference potential for analog signals	0-V-connection (low resistance connected to housing)
<b>Binary inputs</b>	<b>8</b>	Permissible voltage between analog input and 0 V connection max.	35 V (destruction limit)
Input voltage range		Assigned binary addresses	8 bytes
• nominal value	24 V DC	Space requirement	1 slot
• for signal "0"	-5 to +5 V (or input open)	Weight approx.	0.36 kg
• for signal "1"	+13 to +30 V		
Input current for signal "1" typ.	2.5 mA		
Delay time typ.	3 ms		

## Ordering data

## IP 243-3 analog module

To be ordered as a separate  
item:

## IP 243-3 manual

German  
English  
French

Order No.

6ES5 243-1AA13

6ES5 998-0KF11  
6ES5 998-0KF21  
6ES5 998-0KF31

## Front connector K

- 43-pin, for crimp connection
- 43-pin, for screw connection

## Standard-function blocks

for IP 243<sup>1)</sup>

Order No.

6XX3 068  
6XX3 081

6ES5 848-7MA01

1) For description see Page 7/119

# SIMATIC S5-135U, S5-155U/H

## Intelligent I/O modules

### IP 244 temperature control module

#### Application



The IP 244 temperature control module is used for controlling and monitoring temperatures and for measuring and monitoring analog values. This module processes temperature control loops, thus offloading the CPU. The IP 244 can replace up to 13 individual controllers.

4

#### Design

The IP 244 contains a microprocessor which implements the control functions in multiplex mode. User setting is also possible.

The module requires one slot.

##### Inputs

- 1 binary input for switching the controller on and off (heating switch); operates only on controllers for which it was configured
- 13 analog inputs for connecting floating (grounding required) or non-floating thermocouples, two-wire connection, linearization by firmware, 0 ... 50 mV: Fe-CuNi, NiCr-Ni, Pt 10%-RhPt, Pt 13%-RhPt in accordance with DIN 43710 for temperatures up to 1600 °C

- 1 compensation input for connecting a Pt 100 resistance thermometer for reference junction temperature compensation (three-wire connection)
- 2 monitoring inputs (0 ... 20 V) for connecting transmitters. These signals are not processed by the controller but only monitored for limits

or

- 8 analog inputs for connecting Pt 100 resistance thermometers (0 ... 500 mV, four-wire connection)

or

- 16 analog inputs for connecting voltage sensors, such as pyrosensors (0 ... 500 mV; two-wire connection).

The analog inputs are designed, with respect to earthing and shielding, with enhanced resistance to interference which allows operation of the module in the proximity of electrical drives.

##### Outputs

- 17 outputs for two-position controller (HEAT-OFF) or three-position controller (HEAT-OFF-COOL); can be selected from 13 two-position to 8 three-position and 1 two-position controllers. The "on" duration of an output (manipulated variable for cooling or heating) during one sampling interval corresponds to the value of the manipulated variable calculated by the controller. Manual operation is possible.

#### Principle of operation

##### Controller characteristics

- 13 controllers can be programmed with P, I and D components
- The threshold value can be selected to avoid pumping of an output
- The sampling time can be selected between 800 ms and 32 s

- Cascade controllers with one master controller and up to twelve secondary follow-up controllers optional
- Separate parameter sets for heating and cooling

Continued on the next page.



## SIMATIC S5-135U, S5-155U/H

## Intelligent I/O modules

## IP 244 temperature control module (continued)

Principle of operation  
(continued)

4

## Controller self-optimization

The module has a self-optimizing facility (see Fig. 4/33) suitable for gradual processes (e.g. in the plastics industry). The module determines the optimum parameters in a heating-up phase.

Preconditions:

- The controlled process must have low-pass characteristics
- Two-position controlled systems must permit a temperature rise of 37 K; three-position controlled systems: 110 K
- The actual value may rise at a rate of 60 K/min, in max. at full heating capacity
- The heat-up phase must not exceed 12 hours

The self-optimization can be activated for each channel by means of a start/stop bit.

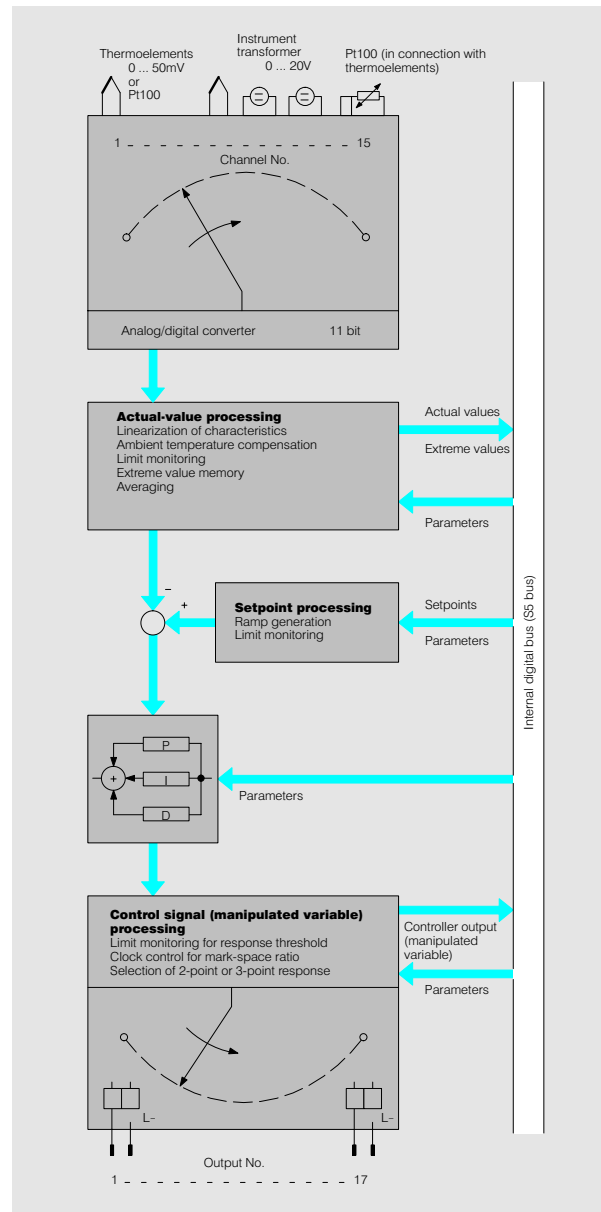

Fig. 4/33 Function diagram of temperature control module

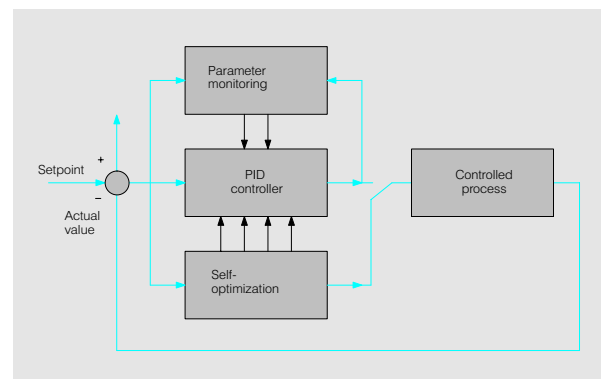

Fig. 4/34 Function diagram of controller self-optimization

## IP 244 temperature control module (continued)

Principle of operation  
(continued)

## Actual-value processing

- Conversion of analog input values to 11-bit digital values
- Monitoring of actual values for two high and two low limits. A signal is given if a first limit is exceeded and the maximum or minimum value reached is stored (can be scanned at any time); if a second limit is exceeded, the controller in question is switched off
- Actual-value averaging is carried out if large deviations or disturbances are to be compensated
- Monitoring of the thermoelement cable for a break in the wire with the following reactions:  
Output of the value of the manipulated variable determined in the past or manual operation or changeover to another thermoelement

## Setpoint processing

- Step changes in the setpoints can be converted into ramp functions with variable slope coefficients

- A second setpoint can be entered (e.g. for reduced temperature at night); either the first or the second setpoint can be selected with a control bit (set by the user program)
- Limit monitoring of the setpoints entered

## Analog output

The CPU can read the manipulated variables of all controllers of the IP 244 in one scanning cycle and therefore transfer the manipulated variables to analog output modules.

## Heating current monitoring

The module can also be programmed for the "closed-loop control with heating current monitoring" mode (thermoelements only).

Failure of the individual heating elements can be detected by monitoring the heating currents. The program evaluates any drop below the permissible heating current range.

## Note

The IP 244 temperature control module must be inserted in the central controller when using the IM 307/IM 317 interface modules.

Operation of the IP 244 temperature control module is permissible only in slots with battery backup.

The necessary software for the CPU is available in the form of standard function blocks (including an example for easy start-up) (see Section 7).

## Technical specifications

## Analog inputs

either

Inputs for thermoelements

Input voltage range

Input resistance

Permissible thermoelements  
(for max. temperature)Inputs for instrument  
transformers

Input ranges (rated values)

Input resistance min.

Temperature compensation  
inputs

or

Inputs for Pt 100

(resistance thermometers,  
max. temperature 830 °C)

Input voltage range

or

Inputs for voltage sensors

Input voltage range

Digital representation of  
input signals (internal)

Galvanic isolation

Measuring principle

13 (two-wire connection)

0 ... 50 mV

10 MΩ

Fe-CuNi (700 °C), type L, type J  
NiCr-Ni (1200 °C); type K  
Pt10%-RhPt (1600 °C); type S  
Pt13%-RhPt (1600 °C); type R

2

0 ... 20 V; can be changed to

0 ... 50 V

50 kΩ (20 V); 10 kΩ (50 mV)

1 for Pt 100

(three-wire connection)

8 (four-wire connection)

0 ... 500 mV

16 (two-wire connection)

0 ... 500 mV

11 bit + sign  
(2048 units = nominal value)

Yes

Integrating

Integrating time  
(adjustable for optimum noise  
suppression)

- At 50 Hz

- At 60 Hz

Conversion time max.

(1 measured value)

- At 50 Hz

- At 60 Hz

Permissible voltage between

- Inputs or between inputs and  
central grounding point max.

- Reference potential of a  
sensor and the

- central grounding point max.

Test voltage

- Analog input to analog input

- Analog input to S5 bus

Fault message for

- Range exceeded

- Wire-breakage

- Limit exceeded  
(programmable limit)

- Short-circuit

Noise suppression for  
 $f = n \cdot (50/60 \text{ Hz} \pm 1 \%)$ ;  
 $n = 1, 2, 3 \dots$ 

- Common mode noise min.

- Series mode noise  
(peak value of the noise  
voltage < rated value  
of the range) min.

20 ms

16 2/3 ms

60 ms

50 ms

18 V ( $V_-$ ,  $V_p$ ; destruction limit)

25 V AC/60 V DC

120 V AC

500 V AC

Yes

Yes

Yes

Yes

100 dB

40 dB

## SIMATIC S5-135U, S5-155U/H

## Intelligent I/O modules

## IP 244 temperature control module (continued)

## Technical specifications (continued)

## Analog inputs (continued)

Basic error limits (for actual value acquisition)	50 mV: $\pm 1.0\%$ $\pm 1$ unit 20 V: $\pm 2.5\%$ $\pm 1$ unit
Operational error limits (0 ... 55 °C)	50 mV: $\pm 3.0\%$ $\pm 1$ unit 20 V: $\pm 3.5\%$ $\pm 1$ unit
Cable length	max. 50 m (164 ft) shielded

## Binary input

Input voltage	24 V DC
• Rated value	- 2 ... + 4.5 V
• For "0" signal	+ 13 ... + 35 V
• For "1" signal	
Input current at "1" signal	typ. 5 mA
Delay	max. 5 ms
Cable length	max. 600 m (1969 ft) unshielded

## Controller

Sampling time $T_A$ (cycle time of module)	0.8 ... 32 s
Function	$y = K \cdot (k \cdot x + \frac{1}{T_N} \int x dt + T_D \cdot \frac{dx}{dt})$
Parameters	
• k	0 or 1
• K	0.01 ... 256
• $T_N$	(1 ... 512) · $T_A$ or $T_N = \infty$
• $T_D$	(0.5 ... 512) · $T_A$ or $T_D = 0$
Setpoint	0 ... 1600 °C (11 bit)
Setpoint ramp	0 ... 65 536 K/h
Limit values	Setpoint $\pm 255$ K
Threshold value	0 ... 50 % (of setpoint)
Hysteresis	0 ... 50 % (of setpoint)

## Outputs

Outputs 1 ... 17	Controller outputs
Response	Depends on the programmed controller types: 13 x two-point to 8 x three-point and 1 x two-point
Galvanic isolation	No
Power supply voltage $V_{pos}$	
• Rated value	24 V DC
• Ripple $V_{pp}$	max. 3.6 V
• Permissible range (including ripple)	20 ... 30 V
Output current at "1" signal	
• Rated value	120 mA
• Permissible range	0.2 ... 120 mA
Short-circuit protection	Yes
Limiting of the voltage induced on circuit interruption	to - 1 V
Lamp load	max. 2.4 W
Load factor at 55 °C	100 %
Residual current at "0" signal	max. 2 $\mu$ A
Signal level of the outputs	
• At "0" signal	max. + 3 V
• At "1" signal	min. $V_{pos} - 2.5$ V
Cable length	
• Unshielded	max. 400 m (1312 ft)
• Shielded	max. 1000 m (3300 ft)
<b>General specifications</b>	
Current consumption	
• Internal (at 5 V)	typ. 0.4 A
• External (at 24 V, without load)	typ. 0.05 A
Assigned binary addresses	32 byte
Space requirements	1 slot
Weight	approx. 0.3 kg (0.66 lb)

4

## Ordering data

## IP 244 temperature control module

To be ordered as a separate item:  
**Configuring package for IP 244**  
comprising manual and standard  
FB<sup>1)</sup>

German  
English  
French  
Italian

Order No.

6ES5 244-3AB31

6ES5 244-5AA11  
6ES5 244-5AA21  
6ES5 244-5AA31  
6ES5 244-5AA51

## 721 connecting cables

shielded;  
For binary signals  
(max. 500 m (1640 ft))

2.5 m (8.2 ft)  
3.2 m (10.5 ft)  
5 m (16.4 ft)  
10 m (32.8 ft)  
32 m (104.9 ft)

6ES5 721-4 BC50  
6ES5 721-4 BD20  
6ES5 721-4 BF00  
6ES5 721-4 CB00  
6ES5 721-4 CD20

For analog signals  
(max. 50 m (164 ft))

2.5 m (8.2 ft)  
5 m (16.4 ft)  
10 m (32.8 ft)  
32 m (104.9 ft)  
50 m (164 ft)

6ES5 721-5 BC50  
6ES5 721-5 BF00  
6ES5 721-5 CB00  
6ES5 721-5 CD20  
6ES5 721-5 CF00

1) For description see Page 7/121

# SIMATIC S5-135U, S5-155U/H

## Intelligent I/O modules

### IP 246I and IP 246A positioning modules

#### Application

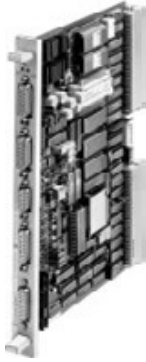

The IP 246 positioning module is used for positioning and position control of two independent axes with variable speed drives.

4

#### Design

Two versions of the IP 246 positioning module are available:

- IP 246I for incremental position encoders

- IP 246A for absolute (digital) position encoders

#### Principle of operation

Machine data and programs required for positioning are stored in the RAM of the IP 246 positioning module. For this, the COM 246 parameterization software (see Section 7) must be loaded into the programming device used.

The user can program target positions and traversing speeds:

- In the program memory of the CPU
- In the program memory of the IP 246 positioning module (with the COM 246 parameterization software)

The current position of the two axes is determined from the signals of the position encoder. From the difference to the current set position, a position controller (P-controller) calculates the current speed set-point, which is output as an analog signal ( $\pm 10$  V) and is available to the speed controller of the current converter of the appropriate axis.

The module can be serviced via two interfaces, either from the programmable controller or from a programming device.

Both axes can be used independent of each other either as a rotary or linear axis.

#### Operation with a programming device

In the diagnostics mode, both axes can be controlled from a programming device. Set-points, actual values, following error and a number of other values are displayed on the screen. Error messages are displayed in detailed plain text.

For operation with a programmer (and for programming), the COM 246 parameterization software is required (see Section 7).

#### Operation with a programmable controller

For communication between the positioning module and the CPU, the appropriate standard function block (FB 164 and FB 165; see Section 7) must be loaded into the CPU. The possible calls are put together in a list (see page 4/66).

The PLC and programming device interfaces can be operated simultaneously. Using the PLC, simple point-to-point linkage of the two axes is possible.

#### Machine data

The machine record includes axis-specific parameters such as

- Various speeds
- Accelerations and decelerations in both directions
- Coordinates for reference point, software position switch
- Offsets, tool compensations
- Resolution
- Type of axis: Rotary or linear axis

# SIMATIC S5-135U, S5-155U/H

## Intelligent I/O modules

### IP 246I and IP 246A positioning modules (continued)

#### Principle of operation (continued)

#### Traversing programs

The notation of the traversing programs conforms to a subset of DIN 66025. They are edited on the programming device using either this notation or in plain text.

Up to 255 programs can be stored on the positioning module. A program can be up to 1023 characters long, and the program memory can take a total of 10,000 characters.

Programs can be linked using subroutine calls. Other programmable functions are e.g.:

- Loops, including infinite loops
- On-the-fly changeovers
- Dwell times
- Offsets, tool compensations
- Metric and imperial measures

Each traversing program can be carried out by both axes (even simultaneously).

4

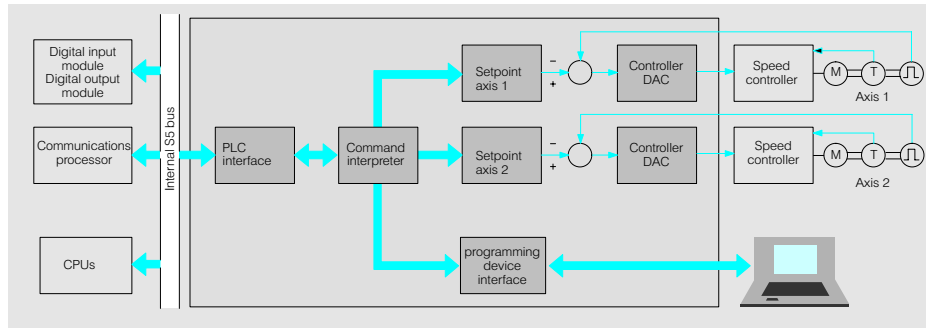

Fig. 4/35 Function diagram of the IP 246 positioning module

#### Functions

Module	IP 246I	IP 246A
Application	Positioning and position control of two independent axes with variable-speed drives	
Encoders used	Incremental • 5 V differential signal • 24 V signal	Absolute (digital) • 24 V signal • Switching to P potential • Switching to M potential
Type of axis	Linear axis Rotary axis	
Modes for • Operator communication	Jogging mode Follow-up mode Reference point approach and/or set reference point Incremental travel Automatic mode Teach-in mode Zero shift Tool offset Entry of machine data and traversing program Module identifier Drift compensation	
• Monitoring	Read machine data Read traversing program Read current actual values Read module identifier Path actual value Following error Distance to go	
Binary outputs signal the following: Selectable via binary inputs	"Axis ready for operation"; "Position reached" External start/stop	
User program referencing the IP 246 Can be stored in	RAM/EPROM CPU	
Machine data and traversing programs can be modified via CPU	Yes	
Module replacement possible without reloading program	Yes	

# SIMATIC S5-135U, S5-155U/H

## Intelligent I/O modules

### IP 246I and IP 246A positioning modules

#### Technical specifications

##### Position detection, incremental

5 V inputs (to RS 422)

Two 90° displaced pulses, zero mark, and the inverse signals

24 V inputs

Two 90° displaced pulses and zero mark

Input voltage

- Rated value
- For "0" signal
- For "1" signal

24 V DC      5 V DC (RS 422)  
 - 33 ... + 3 V  
 + 10.5 ... 33 V

Input current (at "1" signal) max.

7 mA

Galvanic isolation

No

Counting frequency

- For 5 V inputs max.
- For 24 V inputs max.

500 kHz  
 50 kHz

Cable length (shielded) max.

32 m (105 ft)

##### Position detection, absolute

max.

20 bit (parallel, Gray code)

Input voltage

- Rated value
- For "0" signal
- For "1" signal

24 V DC  
 - 33 ... + 3 V  
 + 10.5 ... 33 V

Input current (at "1" signal) max.

7 mA

Galvanic isolation

No

Cable length (shielded) max.

32 m (105 ft)

##### Binary inputs/outputs

Galvanic isolation

4/2 per axis

No

Input voltage

- Rated value
- For "0" signal
- For "1" signal

24 V DC  
 - 33 ... + 3.6 V  
 + 13 ... 33 V

Input current typ.

9.5 mA (at 24 V)

Output voltage

- Rated value
- For "0" signal
- For "1" signal

24 V DC  
 + 3 V  
 $V_{\text{pos24}} - 1.5 \text{ V}$

Output current

- Output current at "1" max.
- Permissible range
- Residual current at "0" max.

120 mA (short-circuit proof)  
 5 ... 120 mA  
 0.5 mA

##### Controller output

Voltage range

Analog rotational speed setpoint  
 -10 ... + 10 V

Load resistance min.

5 k $\Omega$

Short-circuit protection

Yes

Cable length (shielded) max.

32 m (105 ft)

##### Machine data (general)

Resolution

0.1 ... 99.9  $\mu\text{m}$

Traversing range max.

$\pm 40,000 \text{ mm}$   
 or infinitely for rotary axis

Traversing speed

1 ... 65,000 mm/min.

Acceleration

10 ... 9999 mm/s<sup>2</sup>

Following error max.

99.999 mm

Speed gain  $K_V$

0.1 ... 99.9/s  
 $\frac{\text{Programmed speed } V}{\text{Following error } \Delta S}$

Backlash compensation max.

64.999 mm

Tool length compensation max.

$\pm 40,000 \text{ mm}$

##### Supply voltages

$V_{\text{pos24}}$

- Rated value
- Ripple  $V_{\text{pp}}$
- Permissible range (including ripple)

24 V DC  
 3.6 V  
 20 ... 30 V

Current consumption (at 5 V) typ.

1.3 A (without position encoder)

Supply current for position encoder at 5 V and 24 V max.

0.3 A per encoder

Supply voltage for 2-wire BERO

22 ... 33 V

Backup

From battery in PLC

Space requirements Weight approx.

0.4 kg (0.9 lb)



# SIMATIC S5-135U, S5-155U/H

## Intelligent I/O modules

### IP 247 positioning module

#### Application

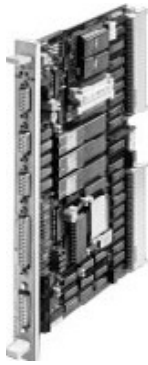

The IP 247 positioning module is used for positioning three independent axes with stepper motors.

4

#### Principle of operation

Machine data and traversing programs required for positioning are stored in the RAM of the IP 247 positioning module. For this, the COM 247 parameter assignment software (see Section 7) must be loaded into the programming device used.

The user can program target positions and traversing speeds

- In the program memory of the CPU or
- In the program memory of the IP 247 (with the COM 247 parameter assignment software).

The module calculates the angular increment to be carried out by the motor from the actual and target positions. The actual position of an axis is not fed back from outside but determined by the module itself.

From the mechanical characteristics of the drive unit (transmission ratio) and the machine data stored on the module (e.g. max. acceleration) the module determines the required pulse sequence (and direction) and transfers this to the power section of the stepper motor. Acceleration and deceleration are calculated using an exponential function: With exponential acceleration a greater path is covered over a given length of time than with linear acceleration.

Stepper motors with two, four or five phases can be controlled with step frequencies of 0.5 Hz to 100 kHz.

#### Operation with a programming device

All three axes can be controlled from a programming device. Actual values, residual path and a number of other values are displayed on the screen. Error messages are displayed in detailed plain text.

For operation with a programming device (and for programming) the COM 247 parameter assignment software is required.

#### Operation with a programmable controller

For communication between the positioning module and the CPU, the appropriate standard function blocks (FB 164 and FB 165; see Section 7) must be loaded into the CPU.

#### Machine data

The machine record includes axis-specific parameters such as:

- Various speeds
- Accelerations (frequency changes)
- Coordinates for reference point, software position switch

- Offsets, tool compensations
- The number of angular increments of the motor per revolution
- Transmission gear ratio of the drive
- Type of axis: rotary or linear axis

#### Traversing programs

The program memory takes 7000 characters. The rest same as for IP 246.

#### Operating modes

The following groups of modes are possible:

- Set reference point procedure and reference point by software
- Modes for manual traversing
- Automatic modes
- Input and deletion of compensations and shifts
- Teach-in mode



## SIMATIC S5-135U, S5-155U/H

## Intelligent I/O modules

## IP 247 positioning module (continued)

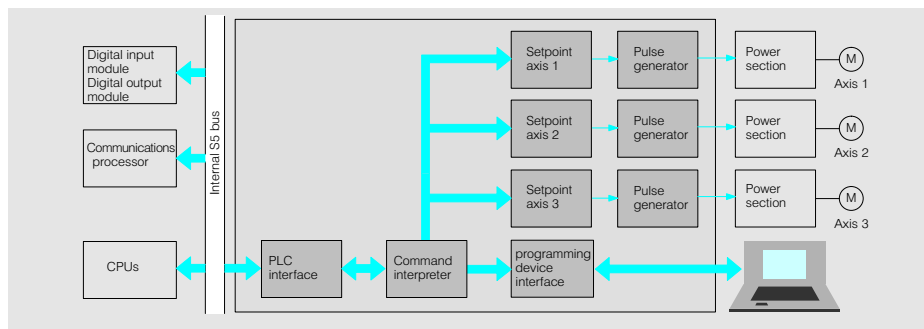

Fig. 4/36 Function diagram of the IP 247 positioning module

## Technical specifications

## Signal to the power section

Positioning outputs

Pulse,  $\overline{\text{Pulse}}$   
Direction,  $\overline{\text{Direction}}$   
Reset,  $\overline{\text{Reset}}$ 

Signal level for power section with

- Optocouplers

5 V/20 mA, 24 V/20 mA  
jumper-selectable;  
5 V to 24 V/20 mA with  
additional voltage  
5 V

- Differential inputs

Ready signal input

- Rated value
- For "0" signal
- For "1" signal
- Input current (at 24 V) typ.

24 V DC  
- 33 ... + 3 V  
+ 10.5 ... 33 V  
7 mA

## Binary inputs/outputs

Signal output "Position reached"

- Rated value
- For "0" signal max.
- For "1" signal min.
- Output current at "1" max.
- Permissible range
- Residual current at "0" max.

24 V DC  
3 V  
 $V_{\text{pos}24} - 1.5 \text{ V}$   
120 mA  
5 ... 120 mA  
0.5 mAInputs for position switch (2),  
reference point switch,  
external Start/Stop

- Rated value
- For "0" signal
- For "1" signal
- Input current (at 24 V) typ.

24 V DC  
- 33 ... + 3.6 V  
+ 13 ... V  
9.5 mA

## Machine data

Traversing range

Number of angular increments  
per revolution

Transmission ratio of the drive

Pulse frequency

Frequency gain

Backlash compensation max.

Tool length compensation max.

## Supply voltages

 $V_{\text{pos}24}$ 

- Rated value
- Ripple max.
- Permissible range  
(including ripple)

Current consumption

- Internal (at 5 V) typ.
- External

(at 24 V, without load) typ.

Supply voltage for

2-wire BERO

Battery backup

Cable length max.

Space requirements

Weight approx.

To be preselected with COM 247

 $\pm 100.000 \text{ mm}$   
 $12 \dots 1000 \frac{\text{pulses}}{\text{rev.}}$  $0,012 \dots 64.999 \frac{\text{mm}}{\text{rev.}}$ 12 Hz ... 100 kHz  
 $5 \dots 2599.99 \frac{\text{Hz}}{\text{ms}}$ 

64.999 mm

 $\pm 100.000 \text{ mm}$ 

20 bit (parallel, Gray code)

24 V DC

3.6 V

20 ... 30 V

0.8 A

0.05 A

22 ... 33 V

PLC battery

100 m (328 ft)

1 slot

0.4 kg (0.9 lb)

## Ordering data

Order No.

Order No.

## IP 247 positioning module

without manual

6ES5 247-4UA31

To be ordered as a separate  
item:

## Configuring package for IP 247

comprising manual, standard  
FB<sup>1)</sup> and parameter assignment  
software COM 247<sup>2)</sup>

German

6ES5 247-5AA11

English

6ES5 247-5AA21

French

6ES5 247-5AA31

## Sub D connector

9-pin (plug)

6ES5 750-2AA11

25-pin (plug)

6ES5 750-2AA31

## 704 connecting cable

(open cable end)

- For power section

1.6 m (5.2 ft)

6ES5 704-4BB60

5 m (16.4 ft)

6ES5 704-4B F00

10 m (32.8 ft)

6ES5 704-4CB00

20 m (65.6 ft)

6ES5 704-4CC00

50 m (164 ft)

6ES5 704-4CF00

- For binary inputs and outputs

2 m (6.56 ft)

6ES5 704-5BC00

5 m (16.4 ft)

6ES5 704-5BF00

10 m (32.8 ft)

6ES5 704-5CB00

20 m (65.6 ft)

6ES5 704-5CC00

50 m (164 ft)

6ES5 704-5CF00

1) For description see Page 7/123

2) For description see Page 7/21

# SIMATIC S5-135U, S5-155U/H

## Intelligent I/O modules

### IP 281 counter module

#### Application



The IP 281 counter module is used for acquiring and processing counting pulses up to a frequency of 250 kHz. This module is an economical alternative to the IP 242A and IP 242B counter modules. It is designed for applications where only one or two counter channels are required.

4

#### Design

The IP 281 basic board has one counter channel for direct connection of incremental encoders or pulse encoders. A second channel can be connected using an optional plug-in submodule. The two 16- or 32-bit counters can operate either independently or in conjunction with one another. The channel(s) can be used for counting both up and down.

The counter function and the bus interface of the IP 281 counter module are implemented in an ASIC. This ensures very fast data interchange with the CPU of the programmable controller. It is therefore particularly suitable for measured value acquisition, interrupt processing and high-speed closed-loop control.

The incremental encoders are connected via Sub D connectors; the digital inputs and outputs are connected via screw terminals (included in the scope of delivery).

The module requires one slot.

#### Features

- One channel for counting up and down (16 or 32 bit), upgradable to two channels (16 or 32 bit) with a plug-in submodule, for connection of incremental encoders
- Five operating modes for independent operation of the two counters
- Four operating modes for operation of the two counters in conjunction with one another
- Individual setting of counting width, counting range and counting mode for each counter

- Counting pulses are acquired from three different evaluations of the signal levels at the encoder inputs (single, double and quadruple evaluation)
- Transfer of values from counter 1 to counter 2 in the form of interrupt or load values
- Direct start of counter 2, when counter 1 has reached an interrupt value
- Enabling/disabling in the form of levels, pulses (at the digital input of the counter) or by software control
- Gate start, gate stop and setting via digital inputs
- Counters loaded with defined initial values
- Comparison with one interrupt value for each counter
- Synchronous setting of start, stop and readout

#### Principle of operation

The IP 281 counter module captures the pulses from incremental encoders depending on direct connectable gate signals. The module evaluates the direction and compares the actual value per counter with a definable

interrupt value. For fast response, the counter outputs can be used and/or an interrupt can be sent to the CPU. The counter outputs can be configured with a selectable minimum pulse or with level switching.

The user program does not require standard function blocks for data exchange with the CPU. High-speed access is achieved via load and transfer operations.

## SIMATIC S5-135U, S5-155U/H

## Intelligent I/O modules

## IP 281 counter module (continued)

## Technical specifications

Number of counters with 16 or 32 bit alternatively	1 upgradable to 2 both up and down with 2 pulse trains displaced by 90° (5 V level, RS 422), also 24 V incremental encoders	Signal input voltage	24 V DC
Number of modes (software-selectable)	5	• Rated value	-3 V ... + 4,5 V
Number of counters with comparison facility for random counts	1 or 2	• For "0" signal	+13 V ... + 30 V
Counting frequency when driven with		• For "1" signal	
• 24 V signals	max. 250 KHz	• Rated value	5 V DC (to RS 422)
• 5 V RS 422 signals	max. 250 KHz	Input current at "1" signal	typ. 13 mA (at 24 V)
Galvanic isolation	Yes	typ. 12 mA (at 5 V)	
• For inputs and outputs	Yes (between encoder and digital inputs)	Output voltage	
• Between two inputs	Yes	• At "0" signal	max. +3 V
• Between input and S5 bus	Yes	• At "1" signal	min. $V_{pos} - 2.5 V$
Power supply voltage $V_{pos}$		Output current at "1" signal	
• Rated value	24 V DC	• Rated value	500 mA
• Ripple $V_{pp}$	max. 3.6 V	Short-circuit protection	Electronic
• Permissible range (including ripple)	20 ... 30 V	Insulation voltage	
• Value at $t > 5 s$	max. 35 V	External connections to housing	
		• In acc. with VDE 0160	75 V DC
		• Tested with	500 V AC
		Current consumption	
		• Internal (at 5 V)	max. 0.6 A
		• External (at 24 V, without load)	max. 2.5 A
		Assigned binary addresses	8 byte with linear addressing
		Space requirements	1 slot
		Weight	approx. 0.4 kg (0.88 lb)

4

## Ordering data

	Order No.		Order No.
<b>IP 281 counter module</b> with 24 V encoder power supply 24 V and 5.2 V encoder power supply	<b>6ES5 281-4UA12</b> <b>6ES5 281-4UP12</b>	<b>703 connecting cable</b> Between IP 281 and	
<b>Plug-in submodule</b> for upgrading with 2nd channel	<b>6ES5 281-4UB12</b>	• Incremental position encoder for 5 V signals, to RS 422, power supply voltage 24 V, with one end open	
To be ordered as a separate item:		10 m (32.8 ft)	<b>6ES5 703-3CB0</b>
<b>IP 281 manual</b>		20 m (65.6 ft)	<b>6ES5 703-3CC0</b>
German	<b>6ES5 998-0KP11</b>	32 m (104.9 ft)	<b>6ES5 703-3CD2</b>
English	<b>6ES5 998-0KP21</b>	50 m (164.0 ft)	<b>6ES5 703-3CF0</b>
French	<b>6ES5 998-0KP31</b>	100 m (328.0 ft)	<b>6ES5 703-3DB0</b>
Italian	<b>6ES5 998-0KP51</b>	• Incremental position encoder for 24 V signals, power supply voltage 24 V, with one end open	
<b>703 connecting cable</b> Between IP 281 and		10 m (32.8 ft)	<b>6ES5 703-4CB0</b>
• Siemens incremental position encoder 6FX2 001-2 ...		20 m (65.6 ft)	<b>6ES5 703-4CC0</b>
5 m (16.4 ft)	<b>6ES5 703-1BF0</b>	32 m (104.9 ft)	<b>6ES5 703-4CD2</b>
10 m (32.8 ft)	<b>6ES5 703-1CB0</b>	50 m (164.0 ft)	<b>6ES5 703-4CF0</b>
20 m (65.6 ft)	<b>6ES5 703-1CC0</b>	100 m (328.0 ft)	<b>6ES5 703-4DB0</b>
25 m (82.0 ft)	<b>6ES5 703-1CC5</b>		
32 m (104.9 ft)	<b>6ES5 703-1CD2</b>	Cable opening	bottom 0 top 1
• Incremental position encoder for 5 V signals, to RS 422, power supply voltage 5 V, with one end open		<b>Sub D connector</b> 15-pin (plug)	<b>6ES5 750-2AA21</b>
5 m (16.4 ft)	<b>6ES5 703-2BF0</b>		
10 m (32.8 ft)	<b>6ES5 703-2CB0</b>		
20 m (65.6 ft)	<b>6ES5 703-2CC0</b>		
25 m (82.0 ft)	<b>6ES5 703-2CC5</b>		
32 m (104.9 ft)	<b>6ES5 703-2CD2</b>		
Cable opening	bottom 0 top 1		

# SIMATIC S5-135U, S5-155U/H

## Signalvorverarbeitende Baugruppen

### Wegerfassungsbaugruppe WF 705

#### Anwendungsbereich

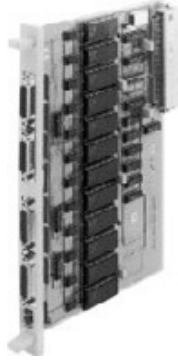

Die Wegerfassungsbaugruppe WF 705 dient dem Erfassen und Verarbeiten der Signale von bis zu 12 synchron-seriellen Absolutwertgebern (SSI).

4

#### Aufbau

An die Wegerfassungsbaugruppe WF 705 lassen sich anschließen:

- 4 Absolutwertgeber, direkt anschließbar

Erweiterung über Istwertverteiler, der die Werte von je 3 Achsen erfaßt; bis zu 4 Istwertverteiler sind an eine Wegerfassungsbaugruppe anschließbar. Der Mischbetrieb (Direktanschluß und Istwertverteiler) ist möglich

Die Baugruppe benötigt 1 Einbauplatz.

#### Arbeitsweise

Bild 4/41 zeigt den prinzipiellen Ablauf des Datenverkehrs zwischen den Wegmeßgebern und der Zentralbaugruppe des Automatisierungsgerätes.

Für den Datenaustausch mit der Zentralbaugruppe sind Standard-Funktionsbausteine für das Anwenderprogramm lieferbar (siehe Katalogteil 7).



Bild 4/41 Funktionsbild des Datenverkehrs zwischen CPU und WF 705

#### Technische Daten

Anschließbare Geber	synchron-serielle Absolutwertgeber (SSI)	Versorgungsstrom für Wegmeßgeber bei 24 V	max.	0,3 A je Geber
Wegerfassung absolut	25 Bit Datenlänge (SSI, Gray- oder Binär-Code)	Leitungslänge (geschirmt) zum Geber		
Verfahrbereich	max. 8192 Winkelschritte je Umdrehung, 4096 Umdrehungen	• bei 125 kbit/s	max.	120 m
Übertragungsgeschwindigkeit	max. 1 Mbit/s	• bei 1 Mbit/s	max.	25 m
Stromaufnahme (bei 5 V)	0,5 A (ohne Geberversorgung)	zum Istwertverteiler	max.	10 m
Versorgungsspannung für Wegmeßgeber	DC 24 V (extern)	Überwachungen		auf Kabelbruch und Kurzschluß
		Belegte Adressen		4 Byte
		Platzbedarf		1 Einbauplatz
		Gewicht	etwa	0,4 kg

Weitere Angaben zu den Wegerfassungsbaugruppen finden Sie im Katalog AR 10.

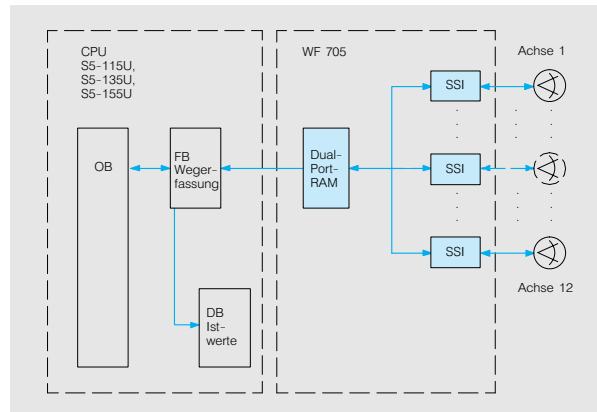
# SIMATIC S5-135U, S5-155U/H

## Signalvorverarbeitende Baugruppen

### Wegerfassungsbaugruppe WF 705 (Fortsetzung)

Bestelldaten	Bestell-Nr.	Preis	Bestell-Nr.	Preis
<b>Wegerfassungsbaugruppe WF 705</b> <b>Istwertverteiler</b> <b>Standard-Software WF 705</b> zur Istwerterfassung auf Disketten 3 1/2" • MS-DOS Einfachlizenz  • 50er-Kopierlizenz  • weitere Kopierlizenzen  zusätzlich zu bestellen ist die <b>Beschreibung WF 705</b> deutsch englisch	<b>6FM1 705-3AA00</b>		<b>Steckleitung 790/590</b> mit offenem Leitungsende, zwischen WF 705 und • SSI-Wegmeßgeber Standardlängen	
	<b>6FM1 590-5AA00</b>			2 m 5 m 10 m 18 m
	<b>6FM1 705-7UA30-1AA0</b>			
	<b>6FM1 705-7UA30-1AA5</b>		Sonderlängen <sup>1)</sup> , max. 25 m bei 1 Mbit/s max. 120 m bei 125 Kbit/s	
	siehe Katalog AR 10			
	<b>6ZB5 440-0AA01-0BA5</b>		• Istwertverteiler Standardlängen	<b>6FM1 790-1HA00</b> <b>6FM1 790-1HB00</b> <b>6FM1 790-1HZ00</b>
	<b>6ZB5 440-0AA02-0BA5</b>		Sonderlängen <sup>1)</sup> , max. 10 m	
			• zwischen Istwertverteiler und SSI-Wegmeßgeber Standardlängen	<b>6FM1 590-2EA00</b> <b>6FM1 590-2EB00</b> <b>6FM1 590-2EC00</b> <b>6FM1 590-2ED00</b> <b>6FM1 590-2EE00</b> <b>6FM1 590-2EF00</b> <b>6FM1 590-2EG00</b> <b>6FM1 590-2EH00</b> <b>6FM1 590-2EZ00</b>
			2 m 5 m 10 m 18 m 25 m 35 m 50 m 60 m	
			Sonderlängen <sup>1)</sup> , max. 25 m bei 1 Mbit/s max. 120 m bei 125 Kbit/s	
			1) Länge im Klartext angeben	

# SIMATIC S5-135U, S5-155U/H

## Signalvorverarbeitende Baugruppen

### Wegerfassungsbaugruppe WF 706 C

#### Anwendungsbereich



Die Positionierungsbaugruppe WF 706 C dient dem Positionieren von Achsen über Abschaltpunkte mit polumschaltbaren Motoren oder (in Verbindung mit einem optionalen Analogmodul) zur Posi-

tionierung von Achsen mit Frequenzumrichtern, Servoantrieben oder Proportionalventil-Steuerungen. Außerdem eignet sich die WF 706 C ausgezeichnet zur Wegerfassung und zum Zählen.

4

#### Aufbau

Die WF 706 C ist in zwei Ausführungen lieferbar:

- Mit 3 Kanälen
- Mit 6 Kanälen

Zur Positionierung mit Frequenzumrichtern ist die WF 706 C modular mit 1 oder 2 Analogmodulen erweiterbar (3- bzw. 6-Kanal-version).

An die Baugruppe lassen sich folgende Geber anschließen:

- Inkrementalgeber
- Absolutwertgeber mit serieller Datenübertragung (SSI-Geber)
- Einfache 24-V-Signalgeber (BERO)

Durch die geringe Schnittstellenbreite von 8 Byte im Peripheriebereich können bis zu 16 Baugruppen in einem Automatisierungsgerät betrieben werden.

Die Baugruppe benötigt 1 Einbauplatz bei 3 Kanälen und 2 Einbauplätze bei 6 Kanälen.

#### Arbeitsweise

Je nach Variante können mit der WF 706 C drei oder sechs Achsen betrieben werden. Durch die einfache und offene Struktur stehen viele Funktionen zur Verfügung, z. B.

- Positionieren über Abschaltpunkte
- Wegerfassung mit schneller Schaltungsausgabe
- Zähler mit schneller Vergleichswertausgabe
- Dosierzähler

In Verbindung mit Analogmodulen zusätzlich:

- Positionieren von Achsen mit Frequenzumrichtern oder Servoantrieben

- Positionieren von 3 Achsen mit Proportional-Ventilsteuerungen

Mit Hilfe der 4 Digitalausgänge mit einer Schaltleistung von 0,5 A bei 24 V lassen sich alle notwendigen Schütze direkt ansteuern.

Durch die ausschließliche Verwendung von Hardware-Logik und den Einsatz eines speziell für diese Aufgabe entwickelten integrierten Bausteins schalten die Ausgänge in weniger als 50 ms.

Dadurch ist die WF 706 auch als Universalzähler mit maximal 6 Kanälen einsetzbar.

Spezielle Funktionen unterstützen den Zählvorgang. So kann z. B. mit der Tor-Funktion ein Zählvorgang durch ein externes Signal auf einen schnellen Digitaleingang oder alternativ durch einen internen Zeittakt gesteuert werden.

Ein Analogmodul enthält 4 Analogausgänge, von denen drei direkt Kanälen zugeordnet sind. Sie können zur Positionierung von Antrieben (wahlweise  $\pm 10$  V-Schnittstelle oder 0 ... 10 V-Schnittstelle mit Richtungsbit) werden.



Bild 4/42 Struktur eines Kanals mit Analogmodul

# SIMATIC S5-135U, S5-155U/H

## Signalvorverarbeitende Baugruppen

### Wegerfassungsbaugruppe WF 706 C (Fortsetzung)

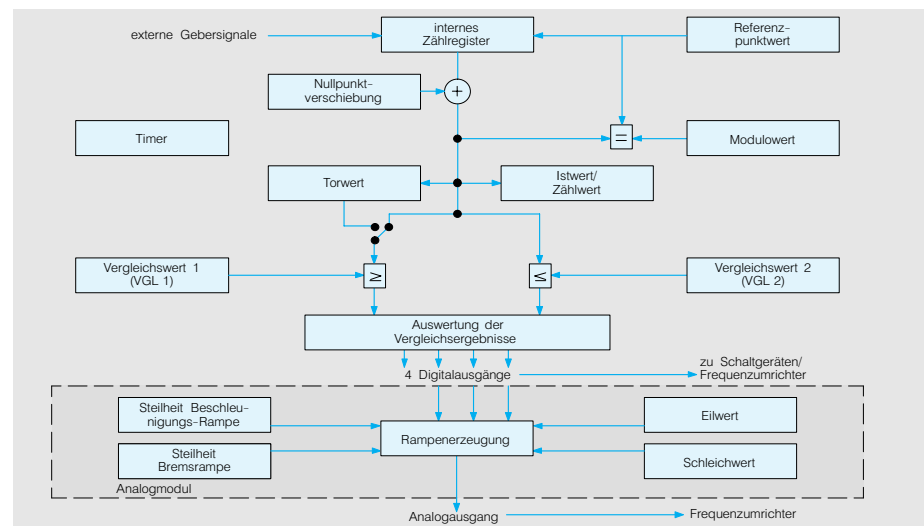
4

Gesteuerte Positionierung mit IP 240 oder WF 706 C			
		IP 240	WF 706
Anzahl der Achsen	max.	2	3/6
Anschließbare Wegmeßger		<ul style="list-style-type: none"> <li>• inkremental 5 V</li> <li>• inkremental 24 V</li> </ul>	<ul style="list-style-type: none"> <li>• inkremental 5 V</li> <li>• SSI-Absolutwertgeber</li> </ul>
Geberfrequenz		500 kHz	500 kHz
bei 5 V inkremental	max.	70 kHz	—
bei 24 V inkremental	max.	—	1 Mbit/s
Übertragungsrate (SSI)	max.	—	—
Verfahrbereich		±9 999 999 Inkremente	16 777 215 Inkremente
Binäreingänge je Achse		Referenznocken (Vorkontakt)	Referenznocken (Vorkontakt)
Binärausgänge je Achse,		2 für <ul style="list-style-type: none"> <li>• Eilgang</li> <li>• Schleichgang- oder</li> <li>• rechts</li> <li>• links</li> </ul>	4 für <ul style="list-style-type: none"> <li>• Eilgang</li> <li>• Schleichgang- oder</li> <li>• rechts</li> <li>• links</li> </ul>
Speicherbare Positionen		254 je Achse	2 je Achse
Reaktionszeit		typ. 2 ms	< 50 µs
Belegte Adressen		16 Byte	8 Byte
Sonderfunktionen		<ul style="list-style-type: none"> <li>• Längenmessung</li> <li>• externe Synchronisation</li> <li>• Zählfunktionen</li> <li>• Rundachse</li> </ul>	<ul style="list-style-type: none"> <li>• Längenmessung</li> <li>• externe Synchronisation</li> <li>• Zählfunktionen</li> </ul>
Besondere Merkmale		<ul style="list-style-type: none"> <li>• selbständige Berechnung der Schaltpunkte</li> </ul>	<ul style="list-style-type: none"> <li>• schneller Datenaustausch mit der CPU</li> <li>• kurze Reaktionszeiten</li> <li>• Analogmodul für Frequenzumrichter (optional)</li> </ul>

### Technische Daten

Anschließbare Geber		inkrementale Geber synchr.-serielle Absolutwertgeber (SSI) 24-V-Signalgeber (BERO)	Verfahrbereich	max.	8192 Winkelschritte je Umdrehung 2048 Umdrehungen nein
<a href="#">Wegerfassung inkremental</a> 5-V-Eingänge (nach RS 422)		symmetrische Signale A, $\bar{A}$ ; B, $\bar{B}$ ; Z, $\bar{Z}$ . Vierfachauswertung erfolgt immer	Potentialtrennung		nein
Verfahrbereich	max.	16 777 215 Inkremente	Übertragungsrate		62,5 kbit/s bis 1 Mbit/s
Potentialtrennung		nein	Leitungslänge (geschirmt)	max.	120 m
Zählfrequenz	max.	500 kHz	bei 125 kbit/s	max.	25 m
Leitungslänge(geschirmt)	max.	35 m	<a href="#">Zählen</a>		
<a href="#">Wegerfassung absolut</a>		13 Bit, 21 Bit und 25 Bit Datenlänge (SSI, Gray- oder Binär-Code) 24 Bit werden ausgewertet	24-V-Eingänge		siehe Binäreingänge
			Zählfrequenz	max.	200 kHz
			Zählbereich	max.	16 777 215
			<a href="#">Binäreingänge</a>		2 je Kanal
			Eingangsspannung		24 V
			Eingangsstrom		5 mA (bei 24 V)
			<a href="#">Binärausgänge</a>		4 je Kanal
			Ausgangsspannung		24 V
			Ausgangsstrom	max.	0,5 A (kurzschlußfest)

# SIMATIC S5-135U, S5-155U/H

## Signalvorverarbeitende Baugruppen

### Wegerfassungsbaugruppe WF 706 C (Fortsetzung)

#### Technische Daten (Fortsetzung)

##### Analogausgänge (optional)

• pro Modul	4
angesteuert durch	3
- WF 706 C	1
- SIMATIC S5	
• Ausgangsspannung	DC - 10 V ... +10 V
Ausgangsstrom	- 5 mA ... + 5 mV
Reaktionszeit	< 50 µs bei ohmscher Last
Überwachungen	auf Kabelbruch und Kurzschluß
Versorgungsspannungen	
• Nennwert	DC 24 V
• Welligkeit $U_{SS}$	3 V
• zulässiger Bereich	20 ... 30 V
(Welligkeit eingeschlossen)	

##### Stromaufnahme (bei 5 V)

• 3-Kanal-Ausführung	0,75 A (ohne Geberversorgung)
• 6-Kanal-Ausführung	1,5 A (ohne Geberversorgung)
Versorgungsstrom für Wegmeßgeber bei	
5 V und bei 24 V	max. 0,3 A je Geber
Belegte Adressen	8 Byte
Platzbedarf	1 Einbauplatz
• 3-Kanal-Ausführung	1 x 1 $\frac{1}{3}$ SEP
• 6-Kanal-Ausführung	2 x 1 $\frac{1}{3}$ SEP
Gewicht	
• 3-Kanal-Ausführung	etwa 0,4 kg
• 6-Kanal-Ausführung	etwa 0,45 kg

4

#### Bestelldaten

	Bestell-Nr.	Preis		Bestell-Nr.	Preis
<b>Positionierbaugruppe WF 706 C</b>			<b>Steckleitung 790</b>		
mit 3 Kanälen	<b>6FM1 706-3AA20</b>		zwischen WF 706 und		
mit 6 Kanälen	<b>6FM1 706-3AB20</b>		• Heidenhain-Wegmeßgeber		
<b>Analogmodul</b>	<b>6FM1 706-4AA00</b>		ROD 320		
zusätzlich zu bestellen ist			Standardlängen	5 m	<b>6FM1 790-1BB00</b>
<b>Beschreibung WF 706</b>	<b>6ZB5 440-0KR01-0BA7</b>			10 m	<b>6FM1 790-1BC00</b>
mit Beispielprogramm-Diskette				18 m	<b>6FM1 790-1BD00</b>
			Sonderlängen <sup>1)</sup> : max. 35 m		<b>6FM1 790-1BZ00</b>
			• Siemens-Wegmeßgeber		
			6FC9 320 oder 6FX2 001-2		
			Standardlängen	2 m	<b>6FM1 790-1CA00</b>
				5 m	<b>6FM1 790-1CB00</b>
				10 m	<b>6FM1 790-1CC00</b>
				18 m	<b>6FM1 790-1CD00</b>
			Sonderlängen <sup>1)</sup> : max. 35 m		<b>6FM1 790-1CZ00</b>
			• SSI-Wegmeßgeber		
			mit offenem Leitungsende		
			Standardlängen	2 m	<b>6FM1 790-1FA00</b>
				5 m	<b>6FM1 790-1FB00</b>
				10 m	<b>6FM1 790-1FC00</b>
				18 m	<b>6FM1 790-1FD00</b>
			Sonderlängen <sup>1)</sup> :		<b>6FM1 790-1FZ00</b>
			max. 25 m		
			bei 1 Mbit/s		
			max. 120 m bei 125 Kbit/s		
			1) Länge im Klartext angeben.		



# SIMATIC S5-135U, S5-155U/H

## Signalvorverarbeitende Baugruppen

### Nockensteuerwerk WF 707

#### Anwendungsbereich

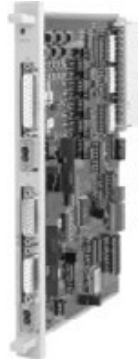

Das Nockensteuerwerk WF 707 dient der Ausgabe von wegababhängigen Schaltfunktionen bei Antrieben mit Linear- und Rundachsen. Das Einsatzgebiet liegt hauptsächlich bei kleinen und schnelllaufenden Maschinen.

4

#### Aufbau

Die Baugruppe verfügt über 16 Nockenbahnen, auf denen insgesamt 32 Nocken verteilt werden können.

An die Baugruppe lassen sich folgende Geber anschließen:

- Inkrementalgeber
- Absolutwertgeber mit serieller Datenübertragung (SSI-Geber)
- Einfache 24-V-Signalgeber (BERO)

Durch die geringe Schnittstellenbreite von 8 Byte im Peripheriebereich können bis zu 16 Baugruppen in einem Automatisierungsgerät betrieben werden.

Die Baugruppe benötigt 1 Einbauplatz.

#### Arbeitsweise

32 Nocken, die beliebig auf 16 Nockenbahnen verteilt werden können, schalten genauer als 1 Grad bei 2400 Takten pro Minute. Das entspricht einer Reaktionszeit kleiner als 60 ms. Bei Verlängerung der Reaktionszeit auf ca. 120 ms stehen sogar 64 Nocken zur Verfügung.

Soll mit linearen Bewegungen gearbeitet werden, können jeweils 32 Nocken beliebig aufgeteilt werden für ein Nockenprogramm „Vorwärts“ und ein Nockenprogramm „Rückwärts“. Die Umschaltung zwischen den beiden Programmen erfolgt entweder mit Hilfe der automatischen Richtungserkennung oder gesteuert durch das Automatisierungsgerät.

Alle Nocken können wahlweise definiert werden als

- Weg-Weg-Nocken oder
- Weg-Zeit-Nocken.

Zusätzlich stehen zur Verfügung:

- Ein Zählnocken
- Ein Bremsnocken.

Durch die geschwindigkeitsabhängige, dynamische Verschiebung gleicht jeder Nocken automatisch die Totzeit des angeschlossenen Stellgliedes aus.

Jeder Nockendatensatz ist während des Betriebes über das Automatisierungsgerät veränderbar, so daß auch an der laufenden Maschine optimiert werden kann. Ein Rücklesen der Istwerte bzw. der aktuellen Nockendaten ist möglich.

Für jede Nockenbahn steht ein Digitalausgang 24 V/0,5 A auf der Baugruppe direkt zur Verfügung. Damit lassen sich die zu steuernden Aggregate direkt oder über Hilfsschütze ansteuern. Nicht benötigte Digitalausgänge können vom Automatisierungsgerät angesteuert werden.

Die Überwachung der

- Gebersignale,
- Synchronisation,
- Digitalausgänge

erhöht die Betriebssicherheit bzw. führt im Fehlerfall zu definierten Betriebszuständen und Meldungen.

Der Digitalausgang „OK-Meldung“ signalisiert den fehlerfreien Betrieb.

Die Synchronisation des Istwertzählers mit dem inkrementalen Geber ist möglich durch

- Geber-Nullmarke,
- externes Synchronisationssignal,
- externes Synchronisationssignal und Geber-Nullmarke (UND-Verknüpfung) und
- Synchronisationsbit vom Automatisierungsgerät.

# SIMATIC S5-135U, S5-155U/H

## Signalvorverarbeitende Baugruppen

### Nockensteuerwerk WF 707 (Fortsetzung)

Gesteuerte Positionierung mit IP 241 und WF 707		
	IP 241	WF 707
Anzahl der Kanäle	2	1
Weggebereingänge	mit Geberanpaßmodul: Geber mit 3-Excess-Gray-Code, BCD-Code, Dual-Code; Analogwertgeber	5-V-Inkrementalgeber (RS 422) 24-V-Inkrementalgeber SSI-Absolutwertgeber
maximale Zählfrequenz	50 kHz für digitale Werte; 200 kHz für absolute, serielle Meßwerteingabe	200 kHz bei 5 V, 100 kHz bei 24 V, 1 Mbit/s bei SSI-Geber
Nockensteuerwerk	pro Kanal 16 Spuren mit je 1 Nocke	16 Spuren mit 32/64 Nocken
Digitalausgänge pro Kanal		16, DC 24 V
Geberversorgung von der Baugruppe	ja	ja

4

### Technische Daten

<b>Für rotatorische Achse</b>		<b>Programmierung</b>	
Nocken pro Nockenprogramm	32	Weg-Weg-Nocken	Start-/Endposition in Inkrementen
Nocken wirksam	vorwärts/rückwärts	Weg-Zeit-Nocken	Startposition in Inkrementen, Zeit als Faktor zur Zykluszeit
Zykluszeit pro Nockenprogramm	57,6 µs	<b>anschließbare Geber</b>	Inkrementalgeber Synchr.-serieller Absolutwertgeber (SSI-Absolutwertgeber) 24-V-Signalgeber (BERO)
Nocken pro Nockenprogramm	64		
Nocken wirksam	vorwärts/rückwärts	erforderlicher Eingangsstrom der Gebersignale	10 mA
Zykluszeit pro Nockenprogramm	115,2 ms	Nutzung des Gebersignals für weitere Baugruppen	max. 5
<b>Für lineare Achse</b>		<b>Wegerfassung, inkrementell</b>	
Nocken pro		5 V-Eingänge (nach RS 422)	symmetrische Signale A, $\bar{A}$ ; B, $\bar{B}$ ; z, $\bar{z}$ . immer Vierfachauswertung
• Vorwärtsprogramm	32		
• Rückwärtsprogramm	32	Verfahrbereich	max. 65 536 Inkremente
Zykluszeit pro Nockenprogramm	57,6 µs	Potentialtrennung	nein
<b>Nocken</b>		Zählfrequenz	max. 500 kHz
Nockenarten	<ul style="list-style-type: none"> <li>• Weg-Weg-Nocken</li> <li>• Weg-Zeit-Nocken</li> <li>• Zähl-Nocken</li> <li>• Brems-Nocken</li> </ul>		
Nockenbahnen	max. 16		
Taktzahl/min	max. 2400		

# SIMATIC S5-135U, S5-155U/H

## Signalvorverarbeitende Baugruppen

### Nockensteuerwerk WF 707 (Fortsetzung)

#### Technische Daten (Fortsetzung)

Wegerfassung, absolut		SSI mit 13 oder 25 Bit Datenlänge (Gray- oder Dual-Code) 16 Bit werden ausgewertet	Überwachungen und Statusmeldungen	<ul style="list-style-type: none"> <li>• Geber-Leitungsbruch</li> <li>• Geberfehler</li> <li>• Kurzschluß/Überlastung der Digitalausgänge</li> <li>• Synchronisation</li> <li>• Istwert</li> <li>• Nockenbahnstatus</li> <li>• Bewegungsrichtung</li> </ul>
Verfahrbereich	max.	65 536 Schritte		
Potentialtrennung		nein		
Übertragungsrate	max.	125 Kbit/s bis 1 Mbit/s		
Digitaleingänge		3	Versorgungsspannungen $U_p$	
Eingangsspannung		DC 24 V	• Nennwert	DC 24 V
Eingangsstrom		5 mA (bei 24 V)	• Welligkeit $U_{ss}$	3 V
Potentialtrennung		nein	• zulässiger Bereich (Welligkeit eingeschlossen)	20 bis 30 V
Eingangsfrequenz	max.	100 kHz	Versorgungsspannung	DC 5 V
Digitalausgänge		16	Stromaufnahme bei DC 5 V ohne Geber	0,25 A
Ausgangsspannung		DC 24 V	Versorgungsstrom für Weggeber bei DC 5 V und DC 24 V	max. 0,3 A
Ausgangsstrom	max.	0,5 A kurzschlußfest	Platzbedarf	1 Einbauplatz
Potentialtrennung		nein	Gewicht	etwa 0,4 kg

#### Bestelldaten

	Bestell-Nr.	Preis	Bestell-Nr.	Preis
<b>Nockensteuerwerk WF 707</b> <b>Steckleitung 790</b> zwischen WF 707 und • WF 707 zum Durchschleifen der Wegistwerte Längen 0,5 m 2,0 m • Heidenhain-Wegmeßgeber ROD 320 • Siemens-Wegmeßgeber 6FC9 320 oder 6FX2 001-2 • SSI-Wegmeßgeber mit offenem Leitungsende	<b>6FM1 707-3AA10</b>  <b>6FM1 790-1JS00</b> <b>6FM1 790-1JA00</b> siehe WF 706C (siehe Seite 4/85) siehe WF 706C (siehe Seite 4/85) siehe WF 706C (siehe Seite 4/85)		<b>Wegmeßgeber</b> • für Anbau 1000 Pulse/Umdrehung 2000 Pulse/Umdrehung 2500 Pulse/Umdrehung • für Einbau in Motoren der Baureihe 1 FT • weitere Wegmeßgeber  zusätzlich zu bestellen ist die <b>Beschreibung WF 707</b> mit Beispielprogramm-Diskette und EMV-Richtlinien	<b>6FX2 001-2CB00</b> <b>6FX2 001-2CC00</b> <b>6FX2 001-2CC50</b>  siehe Katalog SD 12 siehe Katalog ST 71  <b>6ZB5 440-0ST01-0BA3</b>

Weitere Angaben zum Nockensteuerwerk finden Sie im Katalog AR 10.

# SIMATIC S5-135U, S5-155U/H

## Signalvorverarbeitende Baugruppen

### Positionierbaugruppen WF 721/WF 723 A/WF 723 B/WF 723 C

#### Anwendungsbereich

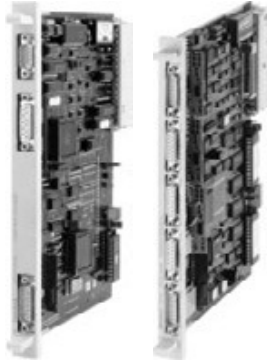

Die Baugruppen WF 721, WF 723 A, WF 723 B und WF 723 C bilden die Positionierfamilie WF 721/WF 723. Diese Baugruppen decken das Positionierspektrum ab bezüglich geregelter Positionieren von drehzahlgeregelten Antrieben für sowohl Einachs- als auch Mehrachs-Anwendungen.

Durch sie lassen sich die elektrischen und hydraulischen Achsen von Maschinen

und Anlagen einfach und wirtschaftlich automatisieren, z. B.:

- Transferstraßen
- Fördereinrichtungen
- Montagelinien
- Beschickungseinrichtungen
- Pressen
- Holzbearbeitungsmaschinen
- Verpackungsmaschinen
- Handhabungsgeräte, Portale
- Sondermaschinen
- Rundtaktmaschinen

4

#### WF 721/WF 723 A

Die Positionierbaugruppe WF 721 ist für typische Einachs-Anwendungen geeignet, während die WF 723 A auch für die Anwendung von mehreren unabhängigen Achsen ausgelegt ist. Die Positionierbaugruppen WF 721/WF 723 A

sind bezüglich der Funktionalität und der Datenformate der WF-Parameter identisch. Das heißt, ein Maschinendatensatz einer WF 723 A-Achse kann auch von einer WF 721-Achse interpretiert werden und umgekehrt. Die WF 721 besitzt

darüber hinaus im Vergleich zu einer WF 723 A einen doppelt so schnellen Meßkreis-takt. Sie ist deshalb besonders für dynamische Einachs-Positionieraufgaben geeignet.

#### WF 723 B

Die Positionierbaugruppe WF 723 B setzt auf der Funktionalität der WF 721/WF 723 A auf und ergänzt das Positionierspektrum in der SIMATIC S5 hinsichtlich NC-Funktionalität. Die Positio-

nierbaugruppe WF 723 B beinhaltet Bearbeitungsfunktionen wie Linear- und Zirkularinterpolation, Spindelfunktionen, Parameterrechnung und Standard-Bohrzyklen. Die Baugruppe WF 723 B läßt

sich für drei Vorschubachsen, zwei Vorschubachsen und eine Spindel oder für drei Vorschubachsen und eine externe Spindel verwenden.

#### WF 723 C

Neben Einachs- und NC-Anwendungen gibt es weitere Positionieraufgaben, wobei mehrere Achsen in einem Verfahrenprogramm koordiniert und damit verkettet zu verfahren

sind. Die Positionierbaugruppe WF 723 C vervollständigt mit dieser Funktionalität die Positionierfamilie WF 721/WF 723. Weitere wichtige Anforderungen können mit der

WF 723 C erfüllt werden, z. B. schnelles und exaktes Positionieren von Walzenvorschüben und Gleichlauf von maximal 3 Achsen.

#### Aufbau



Bild 4/43 Struktur des Aufbaus zur Positionierung und Lageregelung

Durch die Standardisierung der Nahtstellen lassen sich Peripherie, Hardware- und Software-Module baugruppenübergreifend einsetzen. Dies spart Kosten bei der Projektierung, der Inbetriebnahme und dem Service.

An die Baugruppen lassen sich folgende Geber anschließen:

- Inkrementalgeber
- Absolutwertgeber mit serieller Datenübertragung (SSI)

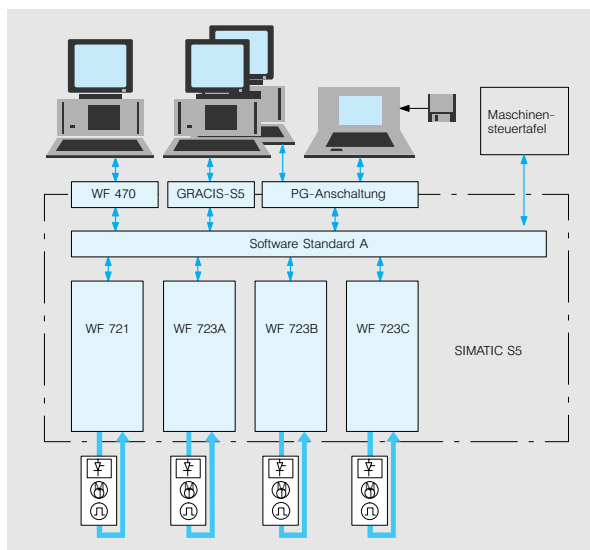
Durch die geringe Schnittstellenbreite von 32 Byte im Peripheriebereich lassen sich bis zu 28 Baugruppen, d. h. 84 Achsen in einem Automatisierungsgerät betreiben.

Die Baugruppen benötigen jeweils 1 Einbauplatz. Ein Betrieb ohne Lüfter ist möglich.

# SIMATIC S5-135U, S5-155U/H

## Signalvorverarbeitende Baugruppen

### Positionierbaugruppen WF 721/WF 723 A/WF 723 B/WF 723 C (Fortsetzung)

#### Arbeitsweise

Die Baugruppen ermöglichen schnelles und genaues Positionieren beim Einrichten,

Zustellen, Handhaben und Transportieren sowie eine hohe Oberflächengüte

bei einfachen Bearbeitungsaufgaben. Folgende Betriebsarten sind möglich:

Betriebsarten	WF 721	WF 723 A	WF 723 B	WF 723 C
Einrichten	x	x	x	x
Referenzpunktfahren	x	x	x	x
Handbetrieb (MDI)	x	x	x	x
Steuern	x	x	x	x
Automatik	x	x	x	x
Automatik-Einzelschritt	x	x	x	x
Automatik-Einzelsatz	—	—	x	x
Nachführbetrieb	x	x	x	x
Slave	—	—	—	x

#### Weitere Merkmale

- Vorschubkorrektur (Override)
- Rundachse

- Beschleunigungsorverride
- Werkzeugkorrektur
- Schnelle Ein-/Ausgänge

Mit Maschinendaten wird die Positionierbaugruppe an die spezielle Bearbeitungstechnologie angepaßt.

#### Geregelte Positionierung mit IP 246, WF 721 oder WF 723 A

	IP 246	WF 721	WF 723 A
Anzahl der Achsen max.	2	1	3
Anschließbare Wegmeßgeber	<ul style="list-style-type: none"> <li>• inkremental 5 V</li> <li>• inkremental 24 V</li> <li>• Absolutwertgeber parallel</li> </ul>	<ul style="list-style-type: none"> <li>• inkremental 5 V</li> <li>• SSI-Absolutwertgeber</li> </ul>	<ul style="list-style-type: none"> <li>• inkremental 5 V</li> <li>• SSI-Absolutwertgeber</li> </ul>
Grundauflösung	0,1 ... 99,9 µm	1, 10, 100 µm	1, 10, 100 µm
Geberfrequenz	—	—	1 Mbit/s
• absolut	—	—	200 kHz
• bei 5 V inkremental max.	500 kHz	200 kHz	—
• bei 24 V inkremental max.	50 kHz	—	—
Verfahrbereich	± 40 m	± 1000 m	± 1000 m
Verfahrgeschw. max.	65 000 mm/min	500 000 mm/min	500 000 mm/min
Beschleunigung	9999 mm/s <sup>2</sup>	99999 mm/s <sup>2</sup>	99999 mm/s <sup>2</sup>
Programmspeicher	10000 Zeichen (etwa 500 Sätze) in bis zu 255 Programmen	bis zu 250 Sätze in bis zu 200 Programmen	bis zu 750 Sätze in bis zu 200 Programmen
Ausgabe	während des gesamten Verfahrnsatzes	zeit- oder quittungsgesteuert vor, während oder nach Verfahrnsatz, istwertbezogen	
M-Funktionen			
Verweilzeiten	100-ms-Schritte	4-ms-Zeit-raster	4-ms-Zeit-raster
Sonderfunktionen			
• Ruckbegrenzung	—	ja	
• schnelle Eingänge für Prozeßsignal	4 Binäreingänge	6/6 Binäreingänge für	
	• Start/Stopp von extern	• externen Satzwechsel	
		• Start von extern	
		• externen Satzwechsel mit fliegendem Istwert-Setzen	
		• fliegendes Messen	
• Simulation	—	ja	
• Satz-Vorlauf/-Rücklauf	—	ja	
• Satz Ausblenden	—	ja	
PG-Anschluß	ja	für COM 723, PC-Steuern zentral über SIMATIC S5-PG-Schnittstelle	
Software für			
• Erstellen von Maschinendaten und Verfahrprogramm	COM 246	COM 723 und Standard B-470, Standard-B-OP25 Standard B-GRACIS	
• Unterstützung bei Test und Inbetriebnahme	COM 246 und Standard-Funktionsbausteine	Standard A und Standard B-470, Standard-B-OP25 Standard B-GRACIS PC-Steuern	

# SIMATIC S5-135U, S5-155U/H

## Signalvorverarbeitende Baugruppen

### Positionierbaugruppen WF 721/WF 723 A/WF 723 B/WF 723 C (Fortsetzung)

#### Programmierung

Der modulare Aufbau der Standard-Software erleichtert das Erstellen maschinenspezifischer STEP 5-Programme. Der Speicher der

SIMATIC S5 wird dabei nicht belastet. Die Programme lassen sich auch im Simulationsbetrieb testen, ohne die Maschine in Betrieb zu nehmen.

Die Kommunikation zwischen der SIMATIC S5 und den Positionierbaugruppen übernimmt die Software Standard A.

Speicherkapazität	WF 721	WF 723 A	WF 723 B	WF 723 C
Anzahl Programme	200	200/Achse	200	200/Achse
Anzahl/Sätze/Programme	100	100	200	200
max. Gesamtanzahl Sätze	250	750	1000	1000

Bedienung über	WF 721	WF 723 A	WF 723 B	WF 723 C
COM 723	x	x	x	x
PC-Steuern	x	x	x	x
Standard B-470	x	x	—	—
Standard B-GRACIS	x	x	x	—
Standard B-OP25	x	x	in Vorbereitung	in Vorbereitung

4

#### COM 723

Komfortabel bei Programmierung und Projektierung und unterstützend bei Inbetriebnahme und Service. Das Software-Paket COM 723 in Verbindung mit SYSDOK 723 hilft. Einfach und schnell lassen sich mit COM 723 Datensätze erstellen und archivieren, die damit im Inbetriebnahme- und Servicefall schnell und unabhängig verfügbar sind.

COM 723 bietet:

- Einfache Handhabung durch bedienergeführte Window-Technik auf Basis Windows 3.1
- Einfache, kurze und flexible Projektierung und Inbetriebnahme durch Plausibilitätskontrollen und Offline-Projektierung im Büro
- Kurze Projektierungszeiten durch das Duplizieren von Anlagendateien und das gemeinsame Datenformat mit Standard B-GRACIS

- Einfacher und schneller Baugruppentausch durch Einstellung und Parametrierung der Baugruppe mittels Job-listen
- Servicefreundlichkeit durch das schnelle Vergleichen von Dateninhalten
- Gut lesbare Datensätze durch mögliche anwenderspezifische Erläuterungen
- Schneller Zugriff auf unterstützende Informationen durch die systemintegrierte, papierlose Dokumentation SYSDOK 723

#### SYSDOK 723

Die Systemintegrierte Dokumentation SYSDOK 723 beinhaltet die papierlose Form der jeweiligen Funktionsbeschreibung bzw. Programmieranleitung.

SYSDOK 723 basiert auf dem Standard-Hilfesystem von MS-Windows und läuft in einem eigenen Fenster neben COM 723. Es bietet neben der kontextbezogenen Hilfe folgende Funktionen:

- Einblendung und Sprünge zu verwandten Themen
- Blättern
- schrittweises Zurückverfolgen des Informationspfades
- elektronische Lesezeichen
- elektronische Notizzettel
- Suchen mit zweistufigem Index

#### PC-Steuern

Mit PC-Steuern steht zu Inbetriebnahme- und Testzwecken ein hilfreiches Werkzeug zur Verfügung. Erste Verfahrensergebnisse der Achsen sind ohne die später hinzukommende Maschinensteuertafel möglich.

Im Servicefall kann der Anwender zum Lokalisieren eines Fehlers die Achsen direkt verfahren oder mit Statusanzeige einen Achsfehler im Klartext auslesen.

Vor unbefugten Eingriffen läßt sich das Software-Paket PC-Steuern durch die Funktion Schlüsselschalter schützen. Die Bedienung von PC-Steuern erfolgt unter Windows ab Version 3.1.

# SIMATIC S5-135U, S5-155U/H

## Signalvorverarbeitende Baugruppen

### Positionierbaugruppen WF 721/WF 723 A/WF 723 B/WF 723 C (Fortsetzung)

#### Programmierung (Fortsetzung)

#### Standard Bedienoberfläche

Zur Bedienung und Diagnose der Positionierbaugruppe WF 721/723A stehen Standard-Masken für das Bildschirmsystem WF 470 und das Operator Panel OP 25 zur Verfügung.

Die Kopplung zwischen SIMATIC S5 und dem Visualisierungsgerät erfolgt mit den Software-Paketen Standard B-470 bzw. Standard B-OP 25. Diese bieten standardisierte Masken und ermöglichen zusammen mit der Menütechnik eine komfortable Bedienung. Von der Eingabe der Maschinendaten bei der Inbetriebnahme

über die Programmierung der Verfahrensbewegung bis zur Fehlerdiagnose wird der Anwender mit Masken geführt.

Außerdem besteht die Möglichkeit, die Maschine an den jeweiligen Prozeß durch frei projektierbare Masken anzupassen.

4

#### Standard B-GRACIS

Mit der Bedienoberfläche Standard B-GRACIS können die Bedienung und Diagnose sowie die Datenverwaltung und Datenversorgung der Positionierbaugruppen WF 721/723A und WF 723 B realisiert werden. Standard B-GRACIS ist sowohl unter GRACIS ULB (unterer Leistungsbereich) als auch unter GRACIS OLB (oberer Leistungsbereich) ablauffähig.

Neben Standard-Masken bietet das Visualisierungssystem GRACIS die Möglichkeit, die Maschine an den jeweiligen Prozeß durch frei projektierbare Masken anzupassen. Die einfache Bedienung erfolgt über Menütechnik und Softkey-Leiste.

Standard B-GRACIS bietet:

- Einfache Handhabung durch bedienergeführte Menütechnik und Hinweise in der Statuszeile
- Zeit- und Kostenersparnis in Verbindung mit der SIMATIC S5-CPU durch Standard B-GRACIS-Lösung auf Basis GRAPI (Gracis Applikations Interface)
- Schnelle, kurze Fehlerlokalisierung und Inbetriebnahme durch eindeutige Schnittstellen und Meldungen im Klartext
- Bedienerfreundliche Bedienung durch einmalige Zuordnung der Einheit in der Projektierungsphase
- Einfaches Ändern/Editieren von Datensätzen durch Plausibilitätskontrollen
- Standardbilder, die sich um spezielle Anlagenbilder erweitern lassen

Bei Standard B-GRACIS OLB stehen für die Verwaltung, Versorgung und Projektierung eigene Menüzeile zur Verfügung. Dadurch kann man komfortabel Datensätze kopieren und verliert bei komplexen Anlagen nie den Überblick.

Standard B-GRACIS OLB bietet zusätzlich:

- Hohe Verfügbarkeit im Falle eines Baugruppendefekts durch zentrale Datenarchivierung
- Kurze Projektierungszeiten durch das Duplizieren der Anlagendateien und das gemeinsame Datenformat mit COM 723
- Sowohl lokalen als auch vernetzten Einsatz (PROFIBUS oder Industrial Ethernet)
- Effektive Projektierung durch offene Struktur mit Import-Export-Funktionen
- Gut lesbare Datensätze durch mögliche anwenderspezifische Erläuterungen

#### Technische Daten

	WF 721	WF 723 A	WF 723 B	WF 723 C
Meßsysteme	inkrementelle Geber SSI-Absolutwertgeber	inkrementelle Geber SSI-Absolutwertgeber	inkrementelle Geber SSI-Absolutwertgeber	inkrementelle Geber SSI-Absolutwertgeber
Anzahl Kanäle	1	3 unabhängige Achsen	3 Vorschubachsen oder 2 Vorschubachsen/ 1 Spindel oder 3 Vorschubachsen/ 1 externe Spindel	bis zu 3 unabhängig kombinierbare Achsen 2 Walzenvorschub/ 1 Achse 1 Walzenvorschub 2 Achsen
Verfahrensgeschwindigkeit				
• von mm/min	0,01	0,01	0,05	0,01
• bis mm/min	500 000	500 000	500 000	500 000
Beschleunigung				
• von mm/s <sup>2</sup>			1	1
• bis mm/s <sup>2</sup>	99 999	99 999	99 999	99 999
Ruckbegrenzung				
• von mm/s <sup>2</sup>	1	1	—	1 (in Vorbereitung)
• bis mm/s <sup>2</sup>	999 999	999 999	—	999 999 (in Vorbereitung)
Verfahrensbereich in m	± 999.999 999	± 999.999 999	± 999.999 999	± 999.999 999
max. Spindeldrehzahl (1/min)	—	—	12 000	—

# SIMATIC S5-135U, S5-155U/H

## Signalvorverarbeitende Baugruppen

### Positionierbaugruppen WF 721/WF 723 A/WF 723 B/WF 723 C (Fortsetzung)

Technische Daten (Fortsetzung)				
	WF 721	WF 723 A	WF 723 B	WF 723 C
<b>Kenngrößen</b>				
• 1 Referenzpunkt je Achse	x	x	x	x
• 2 Software-Endschalter	x	x	x	x
• Rundachse rangierbar	x	x	x	x
• Umkehrlose-Kompensation	x	x	x	x
• TEACH IN	x	x	x	x
• Istwertbewertungsfaktor zur Anpassung von Getriebeübersetzungen	x	x	x	x
• 6 Nullpunktverschiebungen	—/—	—/—	3D/2D	2D/—
• Linear-/Zirkularinterpolation	—/—	—/—	x/x	—/—
• Schraubenlinien-/F-Wort-Interpolation	—/—	—/—	x/x	—/—
• Standard-Bohrzyklen/Parameter	—	—	x	—
• orientierter Spindelhalt	—	—	—	x
• Gleichlauf von 3 Achsen	x	x	x	x
• Verfahrprogramme DIN 66025	—	—	—	x <sup>1)</sup>
<b>Walzenvorschub</b>				
Technologische Korrekturen				
• Vorschub/Beschleunigung (Override)	x/x	x/x	x/—	x/x
• Driftkompensation	x	x	x	x
• Werkzeugkorrektur	Länge, Verschleiß	Länge, Verschleiß	Länge, Radius, Verschleiß	Länge, Verschleiß
<b>Eingänge für Prozeßsignale</b>				
• fliegendes Messen/Istwertsetzen	x/x	x/x	x/—	x/x
• Start UND/ODER verknüpft	x	x	x	x
• externer Satzwechsel	x	x	—	x
• Referenzpunktverfahren ohne BERO/-setzen	x/x	x/x	x/—	x/x
• Istwert sperren/ Einlesefreigabe extern	—/—	—/—	—/—	x/x
<b>Ausgänge für Prozeßsignale</b>				
• Änderung von M-Funktionen	x	x	x	x
• Position erreicht und Halt	x	x	x	x
• Achse fährt vorwärts/rückwärts	x	x	x	x
• Startfreigabe	x	x	x	x
• Konstantfahrt/Beschleunigen, Verzögern	—/—	—/—	—/—	x/x
<b>Schaltfunktionen (M-Funktionen, BCD-Ausgabe + 2 Dekaden)</b>				
• quittungs-/zeitgesteuert	x/x	x/x	x/x	x/x
• wegababhängig	x	x	—	—
<b>Überwachungen</b>				
• Systemprogrammspeicher	x	x	x	x
• Busnahstelle	x	x	x	x
• Ein-/Ausgabe der Daten	x	x	x	x
• Schleppabstand	x	x	x	x
• Spannungswerte 5 V, 15 V, 24 V	x	x	x	x
• Meßkreis	x	x	x	x
• Gleichlauftoleranz	—	—	—	—
<b>Versorgungsspannungen</b>				
• Baugruppe (von SIMATIC S5-Bus) Spannung/Stromaufnahme	DC 5 V/ 1,0 A	DC 5 V/ 1,3 A	DC 5 V/ 1,4 A	DC 5 V/ 1,4 A
• Geber				
Spannung intern/extern	DC 5 V/DC 24 V	DC 5 V/DC 24 V	DC 5 V/DC 24 V	DC 5 V/DC 24 V
Stromaufnahme bei DC 5 V/ DC 24 V je Geber	0,3 A	0,3 A	0,3 A	0,3 A
• Eingänge (pro Kanal)				
Spannung/Stromaufnahme	DC 24 V/5 mA	DC 24 V/5 mA	DC 24 V/5 mA	DC 24 V/5 mA
• Ausgänge (pro Kanal)				
Spannung/Strom max.	DC 24 V/500 mA	DC 24 V/500 mA	DC 24 V/500 mA	DC 24 V/500 mA
<b>Signalspannungs-Sollwert</b>				
• Spannung/Strom bei ± 10 V	± 10 V/2 mA	± 10 V/2 mA	± 10 V/2 mA	± 10 V/2 mA





# SIMATIC S5-135U, S5-155U/H

## Special modules

### Overview

#### Overview

Special functions			
Memory	Page	PC functions	Page
CP 516 memory submodule	4/95	CP 581, the integral PC in the SIMATIC	4/96
		CP 581 with COROS LS-B	4/100
		Videomat IV	4/107

Supplementary devices			
Simulation	Page		
Simulation modules	4/104		
313 monitoring module	4/105		

4

### CP 516 memory submodule

#### Application



The CP 516 memory submodule is used for storing large amounts of data which are not constantly required in the user memory of the CPU, e.g.

recipes and message texts. The module can also be used as a backup medium for production data acquisition.

#### Design

Two memory cards can be inserted in the CP 516 memory submodule. Memory cards with flash EPROM are useful for storing data for reading only. For greater data protection when using RAM memory

cards, a lithium battery can be fitted in the CP 516 memory submodule, to ensure that the data is retained when the CP 516 is not plugged in.

The module has a special connection for data interchange with a programming device.

#### Principle of operation

Data storage is controlled by the CPU using a standard function block. The data

handling blocks for communications are already inserted

in the operating system of the central controller (CPU).

#### Technical specifications

Number of memory locations	2	Power loss	max.	5 W
Memory capacity	max. 8 Mbyte	Space requirements		1 slot
Current consumption (at 5 V)	max. 0.8 A	Weight		0.6 kg (1.32 lb)

#### Ordering data

	Order No.		Order No.
<b>CP 516 memory submodule</b>	<b>6ES5 516-3UA11</b>	<b>Memory card</b>	
<b>Standard function blocks</b> including CP 516 manual	see Section 7	RAM, 256 Kbytes	<b>6ES5 374-2AH21</b>
To be ordered as a separate item:		RAM, 512 Kbytes	<b>6ES5 374-2AJ21</b>
<b>CP 516 manual</b>		RAM, 1 Mbytes	<b>6ES5 374-2AK21</b>
German	<b>6ES5 998-1EB11</b>	Flash EPROM, 256 Kbytes	<b>6ES5 374-2FH21</b>
English	<b>6ES5 998-1EB21</b>	Flash EPROM, 1 Mbytes	<b>6ES5 374-2FK21</b>
French	<b>6ES5 998-1EB31</b>	Flash EPROM, 2 Mbytes	<b>6ES5 374-2FL21</b>
		Flash EPROM, 4 Mbytes	<b>6ES5 374-2FM21</b>
		<b>Lithium backup battery</b> for CP 516	<b>6ES5 980-0AE11</b>

# SIMATIC S5-135U, S5-155U/H

## Special modules

### CP 581; the integral PC in the SIMATIC

#### Application



The CP 581 is an AT-compatible PC for use in the S5-115U, S5-135U and S5-155U/H programmable controllers. When linked to the CPU of the programmable controller it offers additional computing power for solving complex automation tasks.

The CP 581 is used for acquisition, processing and storage

of large quantities of data. The CP 581 also allows you to incorporate especially simple PC applications under MS-DOS into automation applications.

Since there is no rotating memory on the basic board, the CP 581 can also be used reliably in applications where the shock level is high.

4

#### Design

The CP 581 has a modular design. It consists of a basic board and optionally a mass storage module and up to 2 slot modules.

##### CP 581 basis board

The basic board contains the following:

- 80486 DX4 microprocessor (100 MHz)
- VGA graphics interface (can be disabled)
- User memory, modular with 4 to 32 Mbyte
- Receptacle for a memory card with 1 Mbyte, 2 Mbyte, 4 Mbyte, 8 Mbyte or 16 Mbyte capacity
- Optional 4 Mbyte onboard silicon disk can be accessed as drive and implemented with flash EPROMS
- 1 V.24/TTY interface (COM 1) for printer
- 1 V.24/RS 485 interface (COM 2) for mouse
- 1 free V.24/RS 485 interface (COM 3)
- 1 VIDEO interface for multi-frequency monitor (3 Coax midi sockets) for distances up to 250 m (820 ft)
- 1 interface for standard keyboard, for distances up to 250 m (820 ft) with remote terminal interface (RTI)

Operator controls and indicators on the front panel:

- "RUN"- "STOP" switch: The tasks executed for the different switch settings can be specified in the user program (e.g. application start in the case of "RUN").
- "RESET" pushbutton
- LEDs: "RUN" (green) for operation "STOP" (red) for interrupts
- LEDs: "Fault" (red) for module faults, "SD" (green) for indicating memory card access

##### Mass storage module

Every basic board can be expanded by a mass storage module.

A mass storage module consists of the following:

- Hard disk drive with at least 800 Mbyte capacity
- 3<sup>1</sup>/<sub>2</sub>" diskette drive
- 1 Centronics interface for e.g. dongle, printer
- 1 free V.24/TTY interface (COM 4)

Operator controls and indicators on the front panel:

- "HD" LED (green) indicates access to the hard disk

##### Slot module

A basic board can be expanded by up to 2 slot modules.

A short AT module can be plugged into a slot module.

The short AT module for the CP 581 can be up to 10 mm wide, 120 mm high and 165 mm deep.

The CP 581 receives its power supply and battery backup from the programmable controller.

The CP 581 integral personal computer requires 1 to 4 slots depending on configuration.

##### CP 581 system software

The CP 581 system software contains communications software for data exchange with the CPU of the programmable controller (see Fig. 4/44) and the CP\_Link software.

CP\_Link enables start-up of the basic board without mass memory module using a programming device or PC via the interface (COM 1) of the CP 581. Using CP\_Link, the operating system and the user program can be loaded into the basic board without mass storage module.

# SIMATIC S5-135U, S5-155U/H

## Special modules

### CP 581, the integral PC in the SIMATIC (continued)

#### Design (continued)

#### Operating system

Communication with the CPU of the programmable controller is supported by the system software of the CP 581 under the MS-DOS operating system.

The German version of the MS-DOS V 6.22 operating system is included in the scope of delivery of the basic board.

Language upgrades for English and French are to be ordered separately.

#### Principle of operation

While the CPU of the programmable controller concentrates on the pure control tasks, the CP 581 integral personal computer handles acquisition, processing and storage of large data quantities. MS-DOS standard user programs can be used for these tasks.

The CPU of the programmable controller communicates with the CP 581 via the S5 backplane bus. This ensures effective data exchange. Standard data handling blocks must be loaded into the program memory of the programmable controller's CPU for data exchange purposes. Addressing of the CP 581 is either linear or via pages (8 Kbyte dual-port RAM).

The CP 581 can also be used as a standard PC.

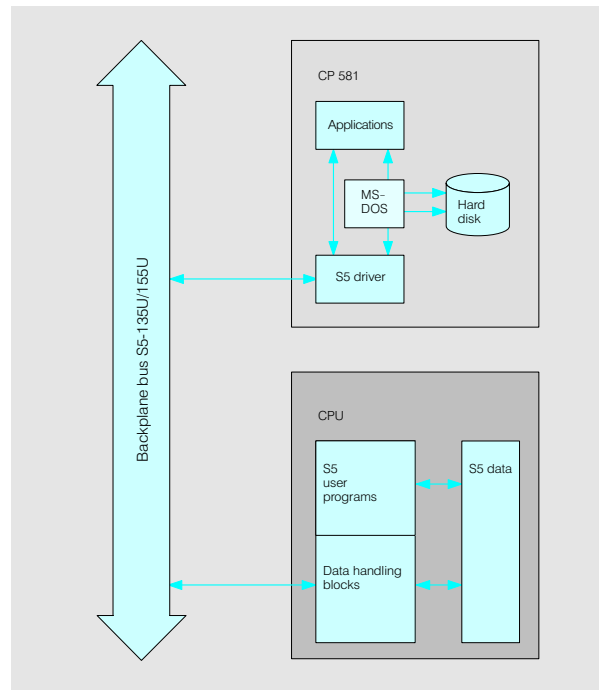

Fig. 4/44 Data exchange between CP 581 and CPU

4

#### Functions

#### Process data acquisition

This function can be used to capture data from different S5 data areas, such as data blocks and bit memories, in the CP 581. This data can be read globally or selectively from the data area within a defined timebase and collected in one or more files in the CP 581. The CP 581 can record the collected and converted process data and then manage and process this data with a suitable MS-DOS user program (e.g. dBASE),

and all independently of the programmable controller.

#### S5 drive emulation

Thanks to the S5 drive emulation, S5 data can easily be incorporated into CP 581 programs.

- S5 data blocks can be converted automatically in order to incorporate them e.g. into standard programs such as Excel or Lotus 1-2-3 without any intermediate steps.
- S5 data blocks can be accessed via almost all MS-DOS commands.

After starting the drive emulation (S5 Remote), the CP 581 provides a new (virtual) drive. This is a logical and not a physical drive. There are 4 catalogs on this drive, one each for the CPUs 1 to 4. The CP 581 stores the data blocks of the CPUs in the catalogs in the form of MS-DOS files. It is operated on-line with data of the S5-CPU.

## SIMATIC S5-135U, S5-155U/H

## Special modules

## CP 581, the integral PC in the SIMATIC (continued)

## Functions (continued)

**Mass storage functions**

If there is insufficient memory space available on the CPU of the programmable controller, it is possible to use these functions to store data in the CP 581 and to fetch it back to the CPU as required - selectively, if desired.

The mass storage functions also offer the facility of deleting an entire CP 581 catalog (without subcatalog) from the CPU.

**Command interpreter**

This function is used to execute any MS-DOS com-

mands on the CP 581 from the CPU. If the CP 581 is operated without keyboard and monitor (e.g. mass memory functions), the command interpreter can be used, if necessary, to copy data on the CP 581 or to execute other necessary MS-DOS functions.

**Programming**

Programming is used to solve all those tasks resulting from communication between the CPU and the CP 581 which cannot be handled by the system programs supplied.

These include, e.g., data exchange with higher-level computers or operator inputs for a CPU.

**Additional functions**

Interrupts are possible from the CP 581 integral PC to the CPU of the programmable controller and vice versa.

Direct network connection is possible via a slot module.

The booting sequence can be selected freely by the user.

4

Technical specifications			
<b>Basic board</b>			
Microprocessor		80486DX4	
Clock frequency		100 MHz	
Coprocessor		Integrated	
Onboard silicon disk (optional)		4 Mbyte	
User memory		Without; can be equipped modularly up to 32 Mbyte	
Ambient temperature		+ 5 °C to + 55 °C	
• Operating		- 20 °C to + 60 °C	
• Transport/storage		8 to 80 % at 25 °C, no condensation	
• Relative humidity			
Supply voltage		5 V DC, ± 5 %	
		24 V DC, + 25 %/- 15 %	
Current consumption			
• At + 5 V	typ.	1.8 A	
• At + 24 V	typ.	0.1 A	
Power loss	approx.	12 W	
Dual-port RAM		8 Kbyte	
Space requirements		1 slot	
Weight		0.5 kg (1.1 lb)	
<b>Mass storage module</b>			
Diskette drive		3 1/2"	
Hard disk drive (memory capacity)	min.	800 Mbyte	
Shock (measured on hard disk drive)			
• Form	max.	1/2 sine	
• Duration	max.	11 ms	
• Operating	max.	50 m/s <sup>2</sup>	
• Transport	max.	500 m/s <sup>2</sup>	
Vibration (measured on hard disk drive)			
• Operating	max.	5 m/s <sup>2</sup>	
• Transport	max.	20 m/s <sup>2</sup>	
Ambient temperature			
• Operating		+ 5 °C to + 55 °C	
• Transport/storage		- 20 °C to + 60 °C	
Relative humidity		8 to 80 % at 25 °C, no condensation	
Supply voltage		5 V DC, ± 5 %	
		24 V DC, + 25 %/- 15 %	
Current consumption			
• At + 5 V	typ.	0.5 A	
• At + 24 V	typ.	0.1 A	
Space requirements		1 slot, beside the basic board	
Weight		0.9 kg (2 lb)	
<b>Slot module</b>			
Ambient temperature			
• Operating		+ 5 °C to + 55 °C	
• Transport/storage		- 20 °C to + 60 °C	
Relative humidity		8 to 80 % at 25 °C, no condensation	
Supply voltage		5 V DC, ± 5 %	
		4 V DC, + 25 %/-15 %	
Current consumption			
• At + 5 V	typ.	0.8 A (without AT module)	
• At + 24 V	typ.	—	
Space requirements		1 slot beside the basic board, mass storage module or slot module	
Weight		0.3 kg (0.66 lb)	

# SIMATIC S5-135U, S5-155U/H

## Special modules

### CP 581, the integral PC in the SIMATIC (continued)

Ordering data	Order No.		Order No.																				
<b>CP 581 basic board</b> for S5-115U/H, S5-135U and S5-155U/H 80 486 DX4 microprocessor 100 MHz, without user memory, incl. MS-DOS V 6.22 German	<b>6ES5 581-0ED13</b>		<b>6ES5 714-2AV01</b>																				
<b>Memory expansion</b> <ul style="list-style-type: none"> <li>For internal RAM               <ul style="list-style-type: none"> <li>4 Mbyte</li> <li>8 Mbyte</li> <li>16 Mbyte</li> <li>32 Mbyte</li> </ul> </li> <li>For Silicon disc (OSD) Flash EPROM 4 Mbyte</li> </ul>	<b>6ES7 478-1AM00-0AA0</b> <b>6ES7 478-1AN00-0AA0</b> <b>6ES7 478-1AP00-0AA0</b> <b>6ES7 478-1AQ00-0AA0</b>  <b>6ES7 478-1BM10-0AA0</b>	<b>RGB/VGA adapter</b> for connecting multi-frequency monitors with standard VGA connector (monitor must be able to filter the sync signals from the green channel)  <b>Connecting cables for monitors</b> (3 cables are required per monitor) <table> <tr> <td></td> <td>3.2 m (10.4 ft)</td> </tr> <tr> <td></td> <td>5 m (16.4 ft)</td> </tr> <tr> <td></td> <td>10 m (32.8 ft)</td> </tr> </table>		3.2 m (10.4 ft)		5 m (16.4 ft)		10 m (32.8 ft)	<b>6ES5 736-2BD20</b> <b>6ES5 736-2BF00</b> <b>6ES5 736-2CB00</b>  <b>6ES5 581-3LA11</b> <b>6ES5 581-0RA12</b>														
	3.2 m (10.4 ft)																						
	5 m (16.4 ft)																						
	10 m (32.8 ft)																						
<b>Y adapter</b> <ul style="list-style-type: none"> <li>For converting COM 1/COM 3 to standard connectors</li> <li>For keyboard/COM 2</li> </ul>	<b>6ES5 714-2AS01</b>  <b>6ES5 714-2AT01</b>	<b>Mass storage module</b>  <b>Slot module</b>  <b>CP 581 system software</b> (3 <sup>1</sup> / <sub>2</sub> " diskette) German, English, French Single license Copy license	<b>6ES5 835-8MD01</b> <b>6ES5 835-8MD01-0KL1</b>																				
<b>Extension for keyboard/mouse</b> RTI (remote terminal interface)	<b>6ES5 751-3AA12</b>																						
<b>RTI connecting cable</b> <table> <tr> <td>10 m (32.8 ft)</td> <td><b>6ES5 714-3CB00</b></td> </tr> <tr> <td>20 m (65.6 ft)</td> <td><b>6ES5 714-3CC00</b></td> </tr> <tr> <td>25 m (82 ft)</td> <td><b>6ES5 714-3CC50</b></td> </tr> <tr> <td>32 m (104 ft)</td> <td><b>6ES5 714-3CD20</b></td> </tr> <tr> <td>40 m (131.2 ft)</td> <td><b>6ES5 714-3CE00</b></td> </tr> <tr> <td>50 m (164 ft)</td> <td><b>6ES5 714-3CF00</b></td> </tr> <tr> <td>63 m (206.6 ft)</td> <td><b>6ES5 714-3CG30</b></td> </tr> <tr> <td>80 m (262.4 ft)</td> <td><b>6ES5 714-3CJ00</b></td> </tr> <tr> <td>100 m (328 ft)</td> <td><b>6ES5 714-3DB00</b></td> </tr> <tr> <td>200 m (656 ft)</td> <td><b>6ES5 714-3DC00</b></td> </tr> </table>	10 m (32.8 ft)	<b>6ES5 714-3CB00</b>	20 m (65.6 ft)	<b>6ES5 714-3CC00</b>	25 m (82 ft)	<b>6ES5 714-3CC50</b>	32 m (104 ft)	<b>6ES5 714-3CD20</b>	40 m (131.2 ft)	<b>6ES5 714-3CE00</b>	50 m (164 ft)	<b>6ES5 714-3CF00</b>	63 m (206.6 ft)	<b>6ES5 714-3CG30</b>	80 m (262.4 ft)	<b>6ES5 714-3CJ00</b>	100 m (328 ft)	<b>6ES5 714-3DB00</b>	200 m (656 ft)	<b>6ES5 714-3DC00</b>		<b>Operating system</b> <b>MS-DOS V 6.22 - Upgrade</b> English French  To be ordered as a separate item: <b>CP 581 manual</b> German English French	<b>6ES5 895-0BS22</b> <b>6ES5 895-0BS32</b>
10 m (32.8 ft)	<b>6ES5 714-3CB00</b>																						
20 m (65.6 ft)	<b>6ES5 714-3CC00</b>																						
25 m (82 ft)	<b>6ES5 714-3CC50</b>																						
32 m (104 ft)	<b>6ES5 714-3CD20</b>																						
40 m (131.2 ft)	<b>6ES5 714-3CE00</b>																						
50 m (164 ft)	<b>6ES5 714-3CF00</b>																						
63 m (206.6 ft)	<b>6ES5 714-3CG30</b>																						
80 m (262.4 ft)	<b>6ES5 714-3CJ00</b>																						
100 m (328 ft)	<b>6ES5 714-3DB00</b>																						
200 m (656 ft)	<b>6ES5 714-3DC00</b>																						
<b>PG keyboard</b>	<b>6ES9 501-3CA00-0AX0</b>	<b>CP 581 DDE server</b> German Single license Copy license English Single license Copy license	<b>6ES5 998-2AT11</b> <b>6ES5 998-2AT21</b> <b>6ES5 998-2AT31</b>  <b>6ES5 835-6DD11</b> <b>6ES5 835-6DD11-0KL1</b>  <b>6ES5 835-6DD21</b> <b>6ES5 835-6DD21-0KL1</b>																				

## SIMATIC S5-135U, S5-155U/H

## Special modules

## Simulation modules

## Application



The simulation modules simulate input and output signals and thereby enable control of input and output modules.

4

## Design

**788-7LA simulation module**

For 16 binary input signals and 16 binary output signals. The module is for use with the 482 digital input/output module.

The module contains the following:

- 16 switches for the input of binary signals; can be used as latching pushbutton (to the left) or as momentary-contact pushbutton (to the right)
- 16 LEDs for indicating binary output signals
- 2 sockets for feeding in the signal voltages
- 1 connection for the 768-7LA cable (0.3 m (1 ft); to be ordered separately) to the 482 digital input/output module

**788-7LB simulation module**

For 1 analog input signal and 1 analog output signal. The module is for use with the 460 analog input module and the 470-7LB analog output module. The module contains the following:

- 1 rotary switch for selecting the input range
- 1 ten-turn potentiometer for setting the input value (scale 0 to 100 %)
- 1 measuring instrument for indicating the input value (scale 0 to 100 %)
- 1 rotary switch for selecting the output range
- 1 measuring instrument for indicating the output value (scale 0 to 100 %)
- 1 connection for the 768-7LB cable (0.3 m (1 ft); to be ordered separately) to the 460 analog input module and to the 470-7LB analog output module

**788-7LC simulation module**

For input and indication of digital values (e.g. timer or counter values). The module is for use with the 482 digital input/output module. It contains the following:

- 1 4-digit key code switch for specifying digital values
- 1 4-digit numerical display for indicating digital values
- 1 connection for the 768-7LA cable (0.3 m (1 ft); to be ordered separately) to the 482 digital input/output module

The simulation modules can be used in the central controller ZG 135U/155U, ZG 135U and in the expansion unit EG 185U.

The modules each require 2 slots.

Ordering data	Order No.		Order No.
<b>788-7LA simulation module</b> for binary signals	<b>6ES5 788-7LA11</b>	To be ordered as a separate item: <b>Manual</b> German English  <b>Connecting cables</b> for simulation modules in S5-135U/155U	<b>6ES5 998-0EA11</b> <b>6ES5 998-0EA21</b>  on request
<b>788-7LB simulation module</b> for analog signals	<b>6ES5 788-7LB11</b>		
<b>788-7LC simulation module</b> for digital values	<b>6ES5 788-7LC11</b>		





# SIMATIC S5-135U, S5-155U/H

## Picture evaluation systems

### Picture evaluation systems

#### Introduction

The optical inspection and recognition of products in manufacturing is becoming an important topic as quality demands and production rates increase. The arguments in its favor are obvious:

- reduction of waste
  - supply of tested products
- These demands can be derived from the rules of DIN ISO 9000 or from the product liability laws.

Monotonous human visual inspection or identification is too expensive and inhumane. Moreover continuously increasing production rates are increasingly making use of personnel for inspection impossible.

Use of a picture evaluation system is an obvious choice:

- Automatic visual inspection in quality assurance; the machine tests objectively, fast and reliably dimensions, contours, forms and presence, correct assembly, positioning and completeness of parts, which can be microscopic (e.g. chip structures)
- Automatic part identification; parts can be assigned to predefined categories by shape, dimension, pattern, color, codes and symbols.

Picture evaluation systems can be used especially economically if certain conditions are fulfilled:

- Features of the product can be described uniquely by shape, dimension and pattern
- Delimitable number of these features
- Delimitable inspection location
- Sufficiently large image of the product to be tested
- High contrast between product and background

4

### SIMATIC VIDEOMAT picture evaluation system

#### Application



SIMATIC VIDEOMAT is a complete picture evaluation system for implementation in the S5-115U, S5-135U/155U or S5-155H programmable controllers. With SIMATIC VIDEOMAT, pictures from both monochrome and color cameras can be evaluated. The automation of visual inspection using picture evaluation systems results in uniform product quality and is therefore both reliable and economical.

The main application for SIMATIC VIDEOMAT is in

- assembly technology in the automotive industry and automotive suppliers, the electrical industry, the plastics industry and in
- packaging technology in the pharmaceutical, cosmetic, foodstuffs and beverage industries.

The module allows:

- Contactless visual inspection for quality assurance (dimensions, contours, shape, existence, assembly, location, quantity)
- Monitoring of high-speed processes
- Inspection of products with high throughput
- Identification of components on the basis of shape, dimensions, pattern, color, codes or characters
- Assignment of components to classes and categories

#### Features

SIMATIC VIDEOMAT has the following special features:

- Up to six cameras can be connected
- Fast moving objects can be captured from different viewpoints
- Picture preprocessing in real-time
- Recorded picture data is accessed while the picture is still being acquired
- Processing rates of up to 30 items per second
- Remote diagnostics and service is possible via modem and telephone lines
- Perfect optimization of the production process due to knowledge from online logging
- Wide range of applications by configuration of the most varied inspection tasks
- Low configuration effort due to easy operation and tried and tested function blocks
- Space saving integration into SIMATIC automation systems

**SIMATIC VIDEOMAT picture evaluation system (continued)****Design**

The module contains:

- 4 Mbyte picture memory, resolution 1024 x 1024 x 8 bit, freely configurable format
- 1024 x 1024 bit overlay and marking or mass storage
- 4 Mbyte program and data memory
- 360 Mbyte hard disk for archiving programs, data and pictures
- SVGA graphical resolution 1024 x 768, display of graphics and video is possible using windowing techniques

Interfaces:

- SVGA video output with simultaneous display of picture and graphic
- PCMCIA interface for connecting a modem for digital picture and data transmission via the telephone lines
- 1 serial (RS232 or TTY) interface and 1 centronics interface
- Keyboard interface, mouse interface
- 8 x 24 V digital inputs
- 8 x 24 V digital outputs

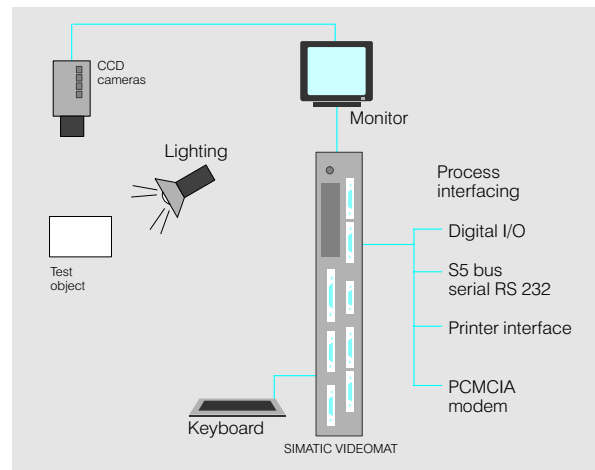

Fig. 4/45 Videomat IV picture evaluation system

Software:

- MS-DOS 6.2 operating system
- System software for interactive generation of applications from monochrome pictures including parameterizable sequencing control and an interface to the process
- Driver for communication via standard data handling blocks

The module requires two slots.

**Principle of operation**

SIMATIC VIDEOMAT is a target system and programming system in one. The request for evaluation and output of the results takes place automatically via communication with the SIMATIC CPU.

Test programs, data and also camera pictures can be archived on-board. In order to program the system, simply connect a monitor and keyboard. On the monitor, up to three pictures, data and graphics can be displayed in windows.

Due to user-friendly operator prompting, the picture evaluation system SIMATIC VIDEOMAT is easily adapted to the specific task, and no programming knowledge is necessary.

**Technical specifications**

Picture processor	80486 DX4, 133 MHz	Monitor connection	1 SVGA
Picture memory	8 Mbyte	Keyboard connection	1
Format	From 256 x 256 x 8 bit to 1024 x 1024 x 8 bit, freely configurable	Mouse connection	1
Operating system	MS-DOS 6.2	24 V digital inputs	8
Interfaces	RGB video output PCMCIA interface for connecting a modem 1 serial (RS232 or TTY) 1 centronics interface	24 V digital outputs	8
		Current consumption	4 A at 5 V
		Space requirements	2 slots

## SIMATIC S5-135U, S5-155U/H

## Picture evaluation systems

## SIMATIC VIDEOMAT picture evaluation system (continued)

Ordering data	Order No.		Order No.
<p><b>SIMATIC VIDEOMAT for monochrome picture evaluation</b> for monochrome cameras, 50 Hz or 60 Hz picture frequency, simultaneous storage of up to 3 camera pictures, system software, runtime license, several languages</p> <ul style="list-style-type: none"> <li>• 6 camera ports</li> <li>• 6 camera ports, with hardware real-time picture processing</li> </ul>	<p><b>6GF2 005-0BC01</b> <b>6GF2 005-0BE01</b></p>	<p><b>CCD camera with C mount</b> 756 x 581 square pixels, 625 lines, 50 half-pictures / s, exposure time adjustable from 1/10,000 to 1/50 s, with restart and reset, voltage rating 12 V DC, 210 mA</p>	<p><b>6GF9 002-1AA</b></p>
<p><b>SIMATIC VIDEOMAT for color picture evaluation</b> for RGB, FBAS, SVHS, Y-C color cameras, 50 Hz or 60 Hz picture frequency, HSI hardware or YUV color coding, system software, run-time license</p> <ul style="list-style-type: none"> <li>• 2 camera ports</li> </ul>	<p><b>6GF2 005-0CC01</b></p>	<p><b>Single-chip-RGB color camera</b> 756 x 581 square pixels, 625 lines, 50 half-pictures / s, exposure time adjustable from 1/10,000 to 1/50 s, voltage rating 12 V DC, 500 mA</p>	<p><b>6GF9 002-1BA</b></p>
<p><b>SIMATIC VIDEOMAT manual</b> German English</p>	<p><b>6GF7 002-1CA01</b> <b>6GF7 002-1CA02</b></p>	<p><b>Lenses for above cameras</b> depending on the application</p>	<p>on request</p>
		<p><b>Lighting equipment</b> depending on the application</p>	<p>on request</p>
		<p><b>14" color monitor</b> max. resolution 1024 x 768 pixels</p>	<p><b>6GF6 130-1MA</b></p>
		<p><b>Keyboard</b></p>	<p><b>C7951-Z727-K3</b></p>
		<p><b>Mouse</b></p>	<p><b>6ES7 790-0AA00-0XA0</b></p>
		<p><b>Connecting cables for VIDEOMAT</b></p>	<p><b>6GF9 002-1AG</b></p>
		<ul style="list-style-type: none"> <li>• Adapter cable for connecting monochrome cameras</li> <li>• Connecting cable for one RGB color camera, Length 10 m (32.8 ft) Length 20 m (approx. 66 ft)</li> </ul>	<p><b>6GF9 002-1BD</b> <b>6GF9 002-1BE</b></p>

# SIMATIC S5-135U, S5-155U/H

## Communications modules

### Communications processors and bus systems

#### Overview

Communications processors are used for data interchange between the S5-135U and S5-155U/H programmable controllers and the I/O stations or other programmable controllers connected to them. Programmable controllers can be linked in two ways:

#### Point-to-point connection

Point-to-point connection is used for connecting one I/O station or programmable controller to a single S5-135U or S5-155U/H programmable controller. The link can, for example, be made through the

second interface of the CPU. The CP 523, CP 524, CP 544 and CP 544B communications processors can also be used. These primarily relieve the CPU of the responsibility for communications thus enabling a large number of I/Os to be connected.

#### Bus interfacing

Bus interfacing is used for interlinking a number of nodes. Possible nodes include:

- S5-135U and S5-155U/H programmable controllers
- Third-party programmable controllers

- Personal computers
- Minicomputers or workstations
- Field equipment
- Printers

There are four different busses to choose from, depending on the area to be covered, the number of nodes and the transmission rate:

- SINEC L1
- AS interface
- PROFIBUS
- Industrial Ethernet

A communications processor is available for each of these four bus systems.

4

Communication		Communication		
	Page		Page	
Point-to-point connection via V.24, 20 mA, RS 422/485		Bus interfacing		
<ul style="list-style-type: none"> <li>• <a href="#">CP 523 communications processor</a> Point-to-point connection with fixed protocols; One interface: V.24, 20 mA</li> <li>• <a href="#">CP 524 communications processor</a> Point-to-point connection with protocols loaded from diskette; Selection of protocols available for connection of third-party systems; One interface: V.24, 20 mA, RS 422/485</li> <li>• <a href="#">CP 544 communications processor</a> Point-to-point connection; Selection of protocols available for connecting third-party systems; two interfaces (interchangeable interface modules): V.24, 20 mA, RS 422/485</li> <li>• <a href="#">CP 544B communications processor</a> as CP 544, but with protocols loaded from diskette (special driver)</li> </ul>	4/110 4/112 4/114 4/114	<ul style="list-style-type: none"> <li>• <a href="#">CP 530 communications processor</a></li> <li>• <a href="#">CP 2430 FMS/DP communications processor</a></li> <li>• <a href="#">CP 5431 FMS/DP communications processor</a></li> <li>• <a href="#">CP 1430 TF/CP 1430 TCP/CP 1473 MAP communications processors</a></li> </ul>	<p><b>SINEC L1</b> for small and medium-sized communications applications Transmission rate 9.6 kbit/s</p> <p><b>AS interface</b> for digital sensors and actuators for the lowest field level</p> <p><b>PROFIBUS</b> to PROFIBUS standard DIN 19245, Part 1 Transmission rate 9.6 to 1500 kbit/s selectable</p> <p><b>Industrial Ethernet</b> CSMA/CD (IEEE 802.3) Transmission rate 10 Mbit/s</p>	4/118 4/122 4/118 4/124

# SIMATIC S5-135U, S5-155U/H

## Communications modules

### CP 523 communications processor

#### Application

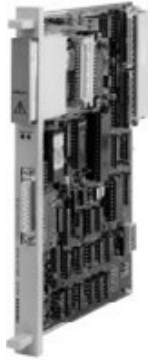

The CP 523 communications processor is used for point-to-point connection to other programmable controllers and third-party equipment using standard protocols.

4

#### Design

The module contains the following:

- Microprocessor (8 bit) and interface chips (USART)
- RAM as user memory for temporary storage of messages
- Receptacle for 375 memory submodule (EPROM, EEPROM with max. 32 Kbyte) for a maximum of 4095 messages
- Hardware clock
- Interface for connection of devices with V.24 or 20 mA current-loop signals (sub D connector, 25-pin)

Operator controls and indicators on the front panel:

- 2 LEDs (green) for indicating the interface status

Devices with serial interfaces can be connected, e.g.:

- Printers
- Terminals
- Keyboards
- Barcode readers
- Programming devices and AT compatible PCs (e.g. in connection with the PRO-DAVE DOS 64R driver software)
- Programmable controllers via CPU 943, CPU 944, CPU 928B or the CP 521, CP 523, CP 544 communications processors (CP 524 and CP 525-2 only in conjunction with special drivers)

#### Interface

The interface is suitable for the transmission of

- 20 mA current-loop signals (TTY) and
- V.24 signals.

The transmission rate of the interface is 200 bit/s up to 9600 bit/s and is selectable in fixed steps.

The module requires one slot.

#### Principle of operation

The CP 523 communications processor can be used for the following functions:

- Interfacing programmable controllers and third-party devices and
- Message printout

The CP 523 handles data communication with the device connected to it completely autonomously, as well as preprocessing and temporary storage of data. The CP 523 occupies 8 byte in the analog I/O area.

All information between the communications processor and the CPU is exchanged via this area.

#### Interfacing

With the CP 523, interfacing to any desired unit with serial interface, e.g. interfacing with a personal computer for operator control and process monitoring, is possible.

Data transfer is possible either with a 10-bit or 11-bit character frame:

10-bit character frame either:

- 1 start bit, 7 data bit, 2 stop bit
- 1 start bit, 7 data bit, 1 parity bit, 1 stop bit
- 1 start bit, 8 data bit, 1 stop bit

# SIMATIC S5-135U, S5-155U/H

## Communications modules

### CP 523 communications processor (continued)

#### Principle of operation (continued)

11-bit character frame either:

- 1 start bit, 7 data bit, 1 parity bit, 2 stop bit
- 1 start bit, 8 data bit, 1 parity bit, 1 stop bit
- 1 start bit, 8 data bit, 2 stop bit

In the communications mode, two open listings and one standardized listing are available on the module:

- In the transparent communications mode, data transmission is without receive-side end identifier sequence (message frames with fixed lengths or evaluation of the character delay time determine the end of the message)

- In the interpretive mode, data transmission commences with receive-side end identifier sequence and control character. The characters RUB OUT = 7Fh, Backspace = 08h, XON/XOFF (assign nothing or 01 h to 7Eh), 1 or 2 end characters (selectable from 01 h to FFh) are evaluated
- In the 3964(R)-K communications mode, data transmission is via the 3964 or 3964R protocol

#### Message printout

With the CP 523 communications processor it is possible to output up to 4095 messages on a peripheral device with serial interface (printer, visual display unit, etc.). The message texts are stored on the module's memory submodule. Each message can have a maximum of three variables.

Permissible variables include the following: Date, time of day, token characters for further message texts, printer control parameters.

#### Programming

Programming of the module is not necessary. Only the type of interface (V.24, TTY), the additional interface parameters (transmission rate, handshake, ...) and the operating

mode (event recorder, interfacing) can be parameterized with the user submodule or via an initialization message from the programmable controller.

See page 4/115 for technical specifications.

Ordering data	Order No.		Order No.
<b>CP 523 communications processor</b>	<b>6ES5 523-3UA11</b>	<b>Manual</b>	
<b>375 memory submodule</b>		German	<b>6ES5 998-0DD11</b>
EPROM 8 Kbyte	<b>6ES5 375-1LA15</b>	English	<b>6ES5 998-0DD21</b>
EPROM 16 Kbyte	<b>6ES5 375-1LA21</b>	French	<b>6ES5 998-0DD31</b>
EPROM 32 Kbyte	<b>6ES5 375-1LA41</b>	Spanish	<b>6ES5 998-0DD41</b>
EEPROM 8 Kbyte	<b>6ES5 375-0LC31</b>	Italian	<b>6ES5 998-0DD51</b>
EEPROM16Kbyte	<b>6ES5 375-0LC41</b>	<b>Connecting cables</b>	see Page 4/116
<b>Program examples</b> for data link	<b>6ES5 897-2UE11</b>		

# SIMATIC S5-135U, S5-155U/H

## Communications modules

### CP 524 communications processor

#### Application



The CP 524 communications processor is used for point-to-point connection to other programmable controllers and third-party equipment using standard protocols. The CP 524 has one interface.

4

#### Design

The module contains the following:

- Microprocessor (8 bit) and interface chips
- RAM for variable data
- 2 dual-port RAM
- Receptacle for 373 memory submodule (EPROM) for up to 128 Kbyte of user program (interprocessor communication functions or message texts)
- Receptacle for interface module for connecting devices with V.24/V.28, 20 mA (TTY) or RS 422-A/RS 485 signals; software clock

Operator controls and indicators on the front panel:

- "RUN"- "STOP" switch "RUN" for normal operation, "STOP" for interrupting normal operation
- 2 LEDs (red) for indicating the interface status

Devices with a serial interface can be connected, e.g.:

- Printers, e.g. DR 210, DR 211, DR 230, DR 231, PT 88 and PT 89 (with ECMA character set)
- Programmable controllers, through CPU 928B or communications processors CP 524, CP 525-2, CP 544, CP 544B

- Programmable controllers via CPU 944 or communications processors CP 523, CP 521SI in conjunction with special drivers
- SICOMP M minicomputers
- AS 215, AS 235K, AS 235 and AS 235H automation systems of the TELEPERM M process control system (see Catalogs PLT 110 and PLT 111)
- Programming devices and AT compatible PCs (e.g. in connection with the PRODAVE DOS 64R driver software, see Section 7)
- Other automation systems
- Third-party computers

Each module requires one slot.

#### Interfaces

Three different interface modules are available for the interface of the CP 524 for transmitting:

- 20 mA current-loop signals (TTY)
- V.24/V.28 signals
- RS 422-A/RS 485 signals

The transmission rate of the interface is

- 110 bit/s to 19,200 bit/s (9600 bit/s with TTY) and is
- selectable in fixed steps using the programming device.

The V.24/V.28 module provides a number of auxiliary signals conforming to the RS 232C or CCITT V.24 standard when using the relevant special driver software (see Section 7).

RS 422-A or RS 485 signals (voltage difference) ensure a higher degree of immunity to noise from external sources than V.24 or TTY signals. The following links can be established in accordance with the EIA standard:

- Point-to-point connections with RS 422-A in full-duplex mode
- Multipoint connections with RS 485 in half-duplex mode (with special driver software)

See page 4/115 for technical specifications.

**CP 524 communications processor** (continued)**Principle of operation**

The CP 524 communications processor is used for the following functions:

- Linking programmable controllers and third-party devices
- Message printout

The CP 524 handles data communication with the devices connected to it completely autonomously, as well as editing and buffering the data.

**Interfacing**

Communications are handled by the RK 512 standard driver program, which is supplied with the COM 525 parameter assignment software (S5-DOS version). For interfacing to third-party computers etc., special driver software may be re-quired (see Section 7). The computer link permits the sending and fetching of all SIMATIC S5 data types, such as data words, peripheral byte, bit memories, input images, etc.

Linking orders for the connected programmable controller or the computer are stored in the memory submodule (EPROM) of the module. Thus, the data do not occupy any memory space in the central controllers (or memory sub-modules).

Data transmission between CP 524 and connected devices is initiated via standard function blocks (handling blocks) in the memory of the central controller.

**Listing****Process status reports**

Production and shopfloor data can be printed out for documentation purposes. Printout is initiated by the user program. Process status reports may be

- up to 99 lines long and
- include up to 40 variables per line.

The variables are transferred to the CP 524 in one single data block.

**Message printouts**

Up to 1000 different messages (e.g. fault messages, signals from limit monitors, changes in switch positions) can be printed out. Each message may have one variable.

**Programming**

The CP 524 can be programmed off-line using the 373 memory submodule. For this purpose, the COM 525 parameter assignment software

(S5-DOS version, see Section 7) must be loaded into the relevant programming device. The parameter assignment software

also supports start-up of the communications processors.

Ordering data	Order No.	Ordering data	Order No.
<b>CP 524 communications processor</b>	<b>6ES5 524-3UA15</b>	<b>Special drivers</b> (customized transmission protocols)	see Section 7
<b>752 interface submodule</b> for CP 524 only for 20 mA current loop (TTY) for V.24/V.28 (RS 232C) for RS 422-A/RS 485	<b>6ES5 752-0AA12</b> <b>6ES5 752-0AA22</b> <b>6ES5 752-0AA43</b>	To be ordered as a separate item: <b>Manual</b> for CP 524 (S5-DOS version) German English French	<b>6ES5 998-1DB11</b> <b>6ES5 998-1DB21</b> <b>6ES5 998-1DB31</b>
<b>373 memory submodule</b> EPROM 32 Kbyte EPROM 64 Kbyte EPROM 128 Kbyte	<b>6ES5 373-1AA41</b> <b>6ES5 373-1AA61</b> <b>6ES5 373-1AA81</b>	<b>Connecting cables</b>	see page 4/116
<b>COM 525 parameter assignment software</b>	see Section 7		



# SIMATIC S5-135U, S5-155U/H

## Communications modules

### CP 544, CP 544B communications processors

#### Application



The CP 544 and CP 544B communications processors are used for fast point-to-point connection to other programmable controllers and equipment of other manufacture with standard protocols. In the case of the CP 544B, custom-er-specific communications protocols can also be used. The CP 544 and the CP 544B have two replaceable interfaces.

4

#### Design

The modules contain the following:

- 80186 microprocessor (16 MHz)
- RAM for variable data
- Two dual-port RAM
- Receptacle for memory card (flash EEPROM) for up to 256 Kbyte (optional)
- 2 receptacles for interface submodules for the connection of devices with V.24/V.28, 20 mA TTY or RS 422-A/RS 485 signals
- Hardware clock

Operator controls and indicators on the front panel:

- "RUN"- "STOP" switch, RUN for normal operation, STOP for interrupting normal operation
- Four LEDs (red/green) for indicating the interface status
- Two LEDs for indicating the status of the module (RUN, STOP)

The following can be connected to the module:

- DR 210, DR 211, DR 230, DR 231, PT 88, PT 89 printers
- SIMATIC S5 programmable controllers via CP 524, CP 544, CPU 928B, CPU 944 and CPU 945; connection is also possible via CP 521 SI and CP 523 (see pages 2/67 and 4/110)
- SICOMP M minicomputers
- Automation systems AS 215, AS 235K, AS 235 and AS 235H from the TELEPERM M process control system (see Catalogs PLT 110 and PLT 111)
- Programming devices and AT compatible PCs (e.g. in connection with the PRO-DAVE DOS 64R driver software)
- Other automation systems
- Third-party computers

#### Interfaces

Three different interface submodules are available for the interfaces of the CP 544 and CP 544B for transmitting:

- 20 mA current-loop signals (TTY),
- V.24/V.28 signals (RS 232C)
- RS 422-A/RS 485 signals

The transmission rate of the interfaces is 300 bit/s to 76800 bit/s (9600 bit/s for TTY, 19200 bit/s V.24 and is selectable in fixed steps using the programming device.

The sum of the two transmission rates must not exceed 76800 bit/s when both interfaces are assigned.

RS 422-A or RS 485 signals (voltage difference) ensure a higher degree of immunity to noise from external sources than V.24 or TTY signals. Moreover, higher transmission rates can be reached. Point-to-point connection with RS 422-A in full-duplex mode can be established in accordance with the EIA standard.

# SIMATIC S5-135U, S5-155U/H

## Communications modules

### CP 544, CP 544B communications processors (continued)

#### Principle of operation

The CP 544 and CP 544B communications processors enable point-to-point connection to other programmable controllers and computers.

- Third-party devices can be connected via open drivers
- Safe data transport over the transmission line is possible with the help of the 3964 (R) procedure

- A safe end-to-end link between the CPUs of both communications partners can be achieved with the RK 512 standard computer link

The CP 544 and CP 544B communications processors handle data communications with the devices connected to it completely autonomously.

Communications jobs for the programmable controller or the computer can be stored in a data block in the CPU, the internal RAM of the CP 544 and CP 544B or on the additional memory card (flash EEPROM).

#### Programming

The CP 544 is programmed using the COM PP parameterization software. It can be programmed either on-line or off-line via the active TTY interface with the PG 720, PG 740, PG 760, PG 710 Plus,

PG 730, PG 750 and PG 770 programming device. For parameter assignment, the COM PP parameterization software must be loaded into the programming device.

COM PP permits simple, operator-prompted programming and supports both start-up and debugging.

4

### Technical specifications for CP 523, CP 524, CP 544 and CP 544B

Communications processors	CP 523	CP 524	CP 544 and CP 544B
Interfaces	1, asynchronous, serial selectable: 20 mA (current loop) V.24 (RS 232 C)	1, asynchronous, serial plug-in submodule: 20 mA (current loop) V.24 (RS 232 C) RS 422-A/RS 485	2, asynchronous, serial plug-in submodule: 20 mA (current loop) V.24 (RS 232 C) RS 422-A/RS 485
Transmission rate			
• 20 mA (TTY; current loop)	max. 9600 bit/s	9600 bit/s	9600 bit/s
• V.24/V.28 (RS 232 C)	max. 9600 bit/s	19200 bit/s	19200 bit/s
• RS 422-A/RS 485	max. —	19200 bit/s	76800 bit/s
• Sum of both interfaces	max. —	—	76800 bit/s
Transmission protocols	3964 (R) ASCII, interpretive ASCII, transparent	RK 512, with special driver, e. g.: • 3964 (R) • ASCII, interpretive • ASCII, transparent • Customer-specific protocols, for other protocols see Section 7	RK 512, 3964 (R) ASCII, interpretive ASCII, transparent Additional functions for CP 544B: Use of customer-specific communications protocols (special drivers) is possible
Parity	Even, odd, mark, space, none	Even, odd, none	
Data format	7 or 8 bit	5-8 bit	6-8 bit
Character frame	10 or 11 bit	7-12 bit	8-12 bit
Listing			
• Message printouts	max. 4065 messages 3 variables per message Message text stored on memory submodule of CP	1000 messages 1 variable per message Message text stored on memory submodule of CP	
• Process status report	max. —	Production and shopfloor data 99 lines long, 40 variables per line	
Parameterization	Off-line on EPROM/EEPROM or in user program	with COM 525 off-line in EPROM	with COM PP on-line or off-line
Connector	Screw connection Sub D socket, 25-pin	Sliding locking devices Sub D socket, 25-pin Sub D socket, 15-pin	Sliding locking device Sub D socket, 25-pin Sub D socket, 15-pin

## SIMATIC S5-135U, S5-155U/H

## Communications modules

## CP 523, CP 524, CP 544 and CP 544B communications processors (continued)

## Technical specifications for CP 523, CP 524, CP 544 and CP 544B (continued)

Communications processors	CP 523	CP 524	CP 544 und CP 544B
Cable length			
• 20 mA current loop (TTY) max.	Active: 10 m (32.8 ft) Passive	1000 m (3280 ft)	1000 m (3280 ft)
• V.24 max.	16 m (52.4 ft)	16 m (52.4 ft)	16 m (52.4 ft)
• RS 422-A/RS 485 max.	—	1200 m (3936 ft)	1200 m (3936 ft)
Current consumption			
• Module	(5 V) typ. 130 mA	(5 V) max. 1.5 A	(5 V/24 V) max. 0.9 A/0.12 A
• 373 memory submodule (5 V) max.	—	0.3 A	—
• 375 memory submodule (5 V) max.	—	—	—
• 377 memory submodule (5 V) max.	—	—	—
• Interface submodule for			
20 mA current loop (5 V/24 V) max.	—	0.1 A/60 mA	0.1 A/60 mA
V.24/V.28 (5 V) max.	—	0.2 A	0.2 A
RS 422-A/RS 485 (5 V) max.	—	0.5 A	0.5 A
Power loss	1.2 W	7.5 W	4.5 W
Fan required	No	Yes	No
Space requirements	1 slot		
Weight			
• Module approx.	0.3 kg (0.66 lb)	0.4 kg (0.88 lb)	0.5 kg (1.1 lb)
• Memory submodule approx.	0.1 kg (0.22 lb)	0.1 kg (0.22 lb)	0.1 kg (0.22 lb)
• Interface submodule approx.	—	0.1 kg (0.22 lb)	0.1 kg (0.22 lb)

4

## Ordering data

	Order No.		Order No.
<b>CP 544 communications processor</b>	<b>6ES5 544-3UA11</b>	<b>725, 726, 734 connecting cables</b>	
<b>CP 544B communications processor</b>	<b>6ES5 544-3UB11</b>	to other SIMATIC S5 devices via CP 524, CP 525-2, CP 544, CP 544B	
<b>752 interface submodule</b>		• 20 mA current loop (TTY)	
for 20 mA current loop (TTY)	<b>6ES5 752-0AA12</b>	3.2 m (10.4 ft)	<b>6ES5 726-1BD20</b>
for V.24/V.28 (RS 232C)	<b>6ES5 752-0AA22</b>	5 m (16.4 ft)	<b>6ES5 726-1B F00</b>
for RS 422-A/RS 485	<b>6ES5 752-0AA43</b>	10 m (32.8 ft)	<b>6ES5 726-1CB00</b>
		50 m (164 ft)	<b>6ES5 726-1CF00</b>
<b>Memory card</b>		200 m (656 ft)	<b>6ES5 726-1DC00</b>
with flash EPROM, 256 Kbyte	<b>6ES5 374-2KH21</b>	• V.24 (max. 16 m (52 ft))	
with RAM, 256 Kbyte	<b>6ES5 374-2AH21</b>	2 m (6.56 ft)	<b>6ES5 726-8BC00</b>
<b>COM PP parameterization software</b>	see Section 7	3.2 m (10.4 ft)	<b>6ES5 726-8BD20</b>
The instruction manual for COM PP is contained in the CP 544 manual.		5 m (16.4 ft)	<b>6ES5 726-8BF00</b>
<b>CP 544 adapter cable</b>	<b>6ES5 734-4AG00</b>	10 m (32.8 ft)	<b>6ES5 726-8CB00</b>
to programming device connecting cable	see Section 7	16 m (52.4 ft)	<b>6ES5 726-8CB60</b>
<b>Special driver for CP 544B</b> (customer-specific protocols)		• RS 422-A/RS 485 (for CP 524 and CP 544)	
To be ordered as a separate item: <b>CP 544/CP 544B manual</b>		5 m (16.4 ft)	<b>6ES5 725-7B F00</b>
German	<b>6ES5 998-2DB11</b>	10 m (32.8 ft)	<b>6ES5 725-7CB00</b>
English	<b>6ES5 998-2DB21</b>	50 m (164 ft)	<b>6ES5 725-7CF00</b>
French	<b>6ES5 998-2DB31</b>	200 m (656 ft)	<b>6ES5 725-7DC00</b>
		to SICOMP R minicomputers via PROMEA EA 01-G with DUST 3964R	
		• 20 mA current loop	
		3.2 m (10.4 ft)	<b>6ES5 726-3BD20</b>
		5 m (16.4 ft)	<b>6ES5 726-3B F00</b>
		10 m (32.8 ft)	<b>6ES5 726-3CB00</b>
		50 m (164 ft)	<b>6ES5 726-3CF00</b>
		200 m (656 ft)	<b>6ES5 726-3DC00</b>
		• V.24 (max. 16 m (52 ft))	
		2 m (6.56 ft)	<b>6ES5 726-4BC00</b>
		3.2 m (10.4 ft)	<b>6ES5 726-4BD20</b>
		5 m (16.4 ft)	<b>6ES5 726-4BF00</b>
		10 m (32.8 ft)	<b>6ES5 726-4CB00</b>
		20 m (65.6 ft)	<b>6ES5 726-4CC00</b>

# SIMATIC S5-135U, S5-155U/H

## Communications modules

### CP 523, CP 524, CP 544 and CP 544B communications processors (continued)

Ordering data	Order No.	Order No.
<b>725, 726 and 734 connecting cables</b> to SICOMP minicomputers via PROMEA EA 01-E with DU 04 • 20 mA current loop (max. 200 m (656 ft))		
3.2 m (10.4 ft)	<b>6ES5 725-8BD20</b>	
5 m (16.4 ft)	<b>6ES5 725-8B F00</b>	
10 m (32.8 ft)	<b>6ES5 725-8CB00</b>	
50 m (164 ft)	<b>6ES5 725-8C F00</b>	
200 m (656 ft)	<b>6ES5 725-8DC00</b>	
to N10 modem (max. 16 m (52 ft))		
2 m (6.56 ft)	<b>6ES5 726-7BC00</b>	
3.2 m (10.4 ft)	<b>6ES5 726-7BD20</b>	
5 m (16.4 ft)	<b>6ES5 726-7B F00</b>	
10 m (32.8 ft)	<b>6ES5 726-7CB00</b>	
16 m (52.4 ft)	<b>6ES5 726-7CB60</b>	
assigns parameters to the CP 544 with PG 7. and CP 544 adapter cable		
5 m (16.4 ft)	<b>6ES5 734-2BF00</b>	
10 m (32.8 ft)	<b>6ES5 734-2CB00</b>	
25 m (82 ft)	<b>6ES5 734-2CC50</b>	
		for printing with DR 210, DR 211, DR 230, DR 231 printer (with CP 524 and CP 525 only in connection with ECMA character set in the printer) (20 mA current loop up to 1000 m (3280 ft), V.24 up to 16 m (52.5 ft))
		3.2 m (10.4 ft)
		5 m (16.4 ft)
		10 m (32.8 ft)
		50 m (164 ft)
		200 m (656 ft)
		<b>6ES5 726-5BD20</b>
		<b>6ES5 726-5B F00</b>
		<b>6ES5 726-5CB00</b>
		<b>6ES5 726-5C F00</b>
		<b>6ES5 726-5DC00</b>

# SIMATIC S5-135U, S5-155U/H

## Communications modules

### CP 2430 communications processor; AS-Interface

#### Application

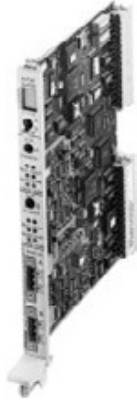

The CP 2430 is an interface master module for connecting the

- SIMATIC S5-115U:  
The CP can be used in CP slots in the central controller and expansion unit via adapters
- SIMATIC S5-135/-155U:  
If used for I/O mode only, can be used in the I/O slots in the central unit and expansion unit; in paging mode the CP can be used in CP slots in the central controller and expansion unit

Depending on the configuration of the PLC up to four CP 2430 can be used in the PLC. Configuration of the CP is not necessary.

Control of up to 2 x 31 AS-Interface slaves in accordance with the ASi specification is implemented.

Up to 496 binary elements can be controlled if bi-directional slaves are used.

The supply voltage is monitored on the AS-Interface profile line.

4

#### Design

- Two AS-Interface masters on one module
- Occupies one slot in the SIMATIC S5
- In I/O mode, 32 bytes are used in the I/O address space
- Display of the connected and activated slaves and their ready-for-operation signals
- Connection of both AS-Interface lines via connectors with terminal blocks (solderless connection with screw locking)
- A pushbutton for each master part for switching the operating state and accepting the existing configuration
- Coding plug for setting addresses and variants

#### Principle of operation

Both AS-Interface masters control a separate AS-Interface segment with up to 31 AS-Interface slaves completely independently of one another

- Two operating variants:  
**Standard mode:**  
Data bits of the slaves can be addressed in the I/O address space of the PLC. Master calls are not possible.

**Expanded mode:**  
Access to master calls in accordance with the ASi specification (e.g. writing parameters) is possible

#### User interface

- Three variants are available:
  - I/O mode:  
Only accesses to slave data in the I/O address space, no master calls
  - I/O and paging operation:  
Accesses to slave data in the I/O address space and master calls via paging access
  - Paging mode:  
Access to slave data and master calls via paging access



# SIMATIC S5-135U, S5-155U/H

## Communications modules

### CP 5431 FMS/DP communications processor; PROFIBUS

#### Application

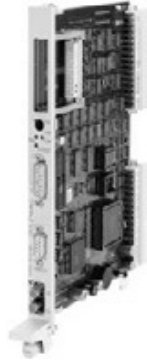

The CP 5431 FMS/DP communications processor is used for connecting the

- S5-115U/H,
- S5-135U and
- S5-155U/H

programmable controllers to the PROFIBUS network.

The programmable controller with the CP 5431 FMS/DP acts as a master on the PROFIBUS network.

4

#### Design

The module contains the following:

- One microprocessor with memory
- One receptacle for 376, 377 memory submodule
- One programming device interface
- One interface for PROFIBUS two-wire line
- One interface for plastic fiber optic cable (PROFIBUS)

Operator controls and indicators on the front panel:

- "RUN" - "STOP" switch
- LEDs for Stop, Run and CP fault

The module requires one slot.

#### Principle of operation

The CP 5431 FMS/DP communications processor handles data communications via the PROFIBUS network or via the PROFIBUS protocol (PROFIBUS FMS). The functions of a DP master (class 1) in accordance with EN 50 170 can also be used (combi-master functions).

The communications processor relieves the programmable controller of a considerable proportion of communications tasks. It is programmed using the COM 5431 FMS/DP parameterization software with operator prompting (see Section 7).

The transmission rate can be set via the software (9.6, 19.2, 93.75, 187.5, 500 kbit/s or 1.5 Mbit/s). The preferred transmission rate of 187.5 kbit/s is preset.

Standard function blocks for the user program are available for data communications with the CPU (see Section 7).

Functions of the CP 5431 FMS/DP in accordance with EN 50 170:

- FDL interface: Direct access to layer 2 services (PROFIBUS layer 2); PLC-PLC connections

- Global I/O interface: Automatic transmission of I/O areas with global I/O
- Distributed I/O interface: Automatic transmission of I/O areas to PROFIBUS DP slaves
- Programming device interface for local and remote programming via the network
- Clock functions: Network-wide clock synchronization
- FMS user interface (PROFIBUS FMS)
- Cyclic I/O interface: Automatic transmission of I/O areas with cyclic interface

# SIMATIC S5-135U, S5-155U/H

## Communications modules

### CP 5431 FMS/DP communications processor; PROFIBUS (continued)

Technical specifications					
<p><b>PROFIBUS overview</b></p> <p>Access method</p> <p>Transmission rate</p> <p>Transmission mode</p> <p>Number of nodes max.</p> <p>Protocols</p>	<ul style="list-style-type: none"> <li>Token passing between the active nodes</li> <li>Master-slave between active and passive nodes in acc. with EN 50170</li> </ul> <p>9.6 to 1500 kbit/s, selectable</p> <p>Bit-serial</p> <p>127 (32 per segment)</p> <p>PROFIBUS-FMS PROFIBUS-DP</p>				
<p><b>PROFIBUS electrical</b></p> <p>Connection of nodes via</p> <p>Topology</p> <p>Transmission medium</p> <p>Max. distance between 2 nodes</p>	<p>RS 485 bus terminal</p> <p>Row/tree structure</p> <p>Twisted pair cable</p> <p>9.6 km at 9.6 kbit/s</p>				
<p><b>PROFIBUS optical</b></p> <p>Connection of nodes</p> <p>Topology</p> <p>Transmission medium</p>	<p>Optical Link Modules</p> <p>Line, ring or star structure</p> <table border="0"> <tr> <td>Glass fiber optic</td> <td>Plastic fiber optic</td> </tr> <tr> <td>62.5/125 μm</td> <td>980/1000 μm</td> </tr> </table>	Glass fiber optic	Plastic fiber optic	62.5/125 μm	980/1000 μm
Glass fiber optic	Plastic fiber optic				
62.5/125 μm	980/1000 μm				
<p>Max. distance between 2 OLMs</p> <p>Possible connections</p> <ul style="list-style-type: none"> <li>No. of optical channels</li> <li>OLM P3/S3</li> <li>OLM P4/S4</li> <li>OLM P4/S4 electrical channels</li> </ul> <p><b>5431 FMS/DP comm. processor</b></p> <p>Supply voltage</p> <p>Current consumption</p> <ul style="list-style-type: none"> <li>At 5 V</li> <li>At 24 V</li> </ul>	<table border="0"> <tr> <td>Glass fiber optic</td> <td>Plastic fiber optic</td> </tr> <tr> <td>2850 m (9348 ft)</td> <td>53 m (173.8 ft)</td> </tr> </table> <p>1</p> <p>2</p> <p>3</p> <p>+ 5 V + 5 %; + 24 V + 25/-15 %</p> <p>450 mA</p> <p>70 mA with RS 485, Average 100 mA, using both current sources of the programming device interface (terminating resistance irrelevant)</p> <p>9-pin sub D socket</p> <p>Plastic fiber optic cable, HP-duplex</p> <p>15-pin sub D socket</p> <p>0 °C to + 55 °C</p> <p>- 40 °C to + 70 °C</p> <p>1 slot</p> <p>0.4 kg (0.88 lb)</p> <p>0.1 kg (0.22 lb)</p>	Glass fiber optic	Plastic fiber optic	2850 m (9348 ft)	53 m (173.8 ft)
Glass fiber optic	Plastic fiber optic				
2850 m (9348 ft)	53 m (173.8 ft)				
<p><b>PROFIBUS connection to</b></p> <ul style="list-style-type: none"> <li>PROFIBUS (RS 485)</li> <li>PROFIBUS (plastic)</li> </ul> <p>Programming device/diagnostics interface</p> <p>Permissible ambient conditions</p> <ul style="list-style-type: none"> <li>Operating temperature</li> <li>Transport/storage temperature</li> </ul> <p>Space requirements</p> <p>Weight</p> <ul style="list-style-type: none"> <li>Module</li> <li>Memory submodule</li> </ul>					
Ordering data	Order No.	Order No.			
<p><b>CP 5431 FMS/DP communications processor</b></p> <p>SINEC L2 interface module for S5-115U/H, S5-35U, S5-155U/H</p>	<b>6GK1 543-1AA01</b>				
<p><b>COM 5431 FMS/DP parameter asgmt software</b></p>	see Section 7				
<p><b>CP 5431 FMS/DP manual</b></p> <p>German</p> <p>English</p> <p>French</p>	<p><b>6GK1 970-5AB01-0AA0</b></p> <p><b>6GK1 970-5AB01-0AA1</b></p> <p><b>6GK1 970-5AB01-0AA2</b></p>				
<p><b>376 memory submodule (EPROM)</b></p> <p>16 Kbyte</p> <p>32 Kbyte</p> <p>64 Kbyte</p>	<p><b>6ES5 376-1AA11</b></p> <p><b>6ES5 376-1AA21</b></p> <p><b>6ES5 376-1AA31</b></p>				
<p><b>377 memory submodule (RAM)</b></p> <p>16 Kbyte</p> <p>32 Kbyte</p> <p>64 Kbyte</p>	<p><b>6ES5 377-1AA11</b></p> <p><b>6ES5 377-1AA21</b></p> <p><b>6ES5 377-1AA32</b></p>				
<p><b>RS 485 bus terminal for PROFIBUS</b></p> <p>with connecting cable</p> <p>1.5 m (4.92 ft)</p> <p>3.0 m (9.84 ft)</p>	<p><b>6GK1 500-0AA00</b></p> <p><b>6GK1 500-0AB00</b></p>				
<p><b>Bus cables for PROFIBUS</b></p> <p><b>Bus cable<sup>2)3)</sup> 2-wire, shielded</b></p> <p><b>Bus cable, halogen-free</b></p> <p>2-wire, shielded</p>	<p><b>6XV1 830-0AH10</b></p> <p><b>6XV1 830-0CH10</b></p>	<p><b>Bus cable for PROFIBUS (ctd.)</b></p> <p><b>Bus cable with PE coating<sup>2)3)</sup></b></p> <p>2-wire, shielded</p> <p><b>Bus cable (buried)<sup>2)3)</sup></b></p> <p>2-wire, shielded</p> <p><b>Trailing cable<sup>2)3)</sup></b></p> <p>2-wire, shielded</p> <p><b>Bus cable for festoon mounting<sup>2)3)</sup></b></p> <p>2-wire, shielded</p> <p><b>Bus cable for PROFIBUS-PA</b></p> <ul style="list-style-type: none"> <li>blue, for applications in hazardous areas</li> <li>black, for applications in non-hazardous areas</li> </ul> <p><b>FIBER OPTIC CABLE<sup>2)</sup></b></p> <p><b>standard cable, splittable</b></p> <p>without connector, sold by the meter, max. 400 m (1312 ft)</p> <p><b>FLEXIBLE FIBER<sup>2)</sup></b></p> <p><b>OPTIC CABLE</b></p> <p><b>trailing cable, splittable</b></p> <p>without connector, sold by the meter, max. 200 m (656 ft)</p> <p><b>BFOC connector;</b> single for FIBER OPTIC CABLE, standard cable and trailing cable</p> <p>Additional fiber optic cables, PROFIBUS fiber optic network components and PC modules</p> <p><b>6XV1 830-0BH10</b></p> <p><b>6XV1 830-3AH10</b></p> <p><b>6XV1 830-3BH10</b></p> <p><b>6XV1 830-0AH10</b></p> <p><b>6XV1 830-5AH10</b></p> <p><b>6XV1 830-5BH10</b></p> <p>see Section 10</p> <p>see Section 10</p> <p><b>6GK1 901-0DA00-0AA0</b></p> <p>see Catalog IK 10</p>			

1) Up to 187.5 kbit/s

2) Sold by the meter, max. 1000 m (3280 ft), minimum order 20 m (65.6 ft)



# SIMATIC S5-135U, S5-155U/H

## Communications modules

### CP 1430 TF/CP 1430 TCP/CP 1473 MAP communications processors; Industrial Ethernet

#### Application



#### CP 1430 TF/1430 TCP communications processor

The CP 1430 TF/1430 TCP communications processor is used for connecting the

- S5-115U/H,
- S5-135U and
- S5-155U/H

programmable controllers to the Industrial Ethernet cell network in accordance with IEEE 802.3.

Mit dem CP 1430 TF können Kommunikationen in Local Area Networks (LAN) aufgebaut werden.

Mit dem CP 1430 TCP können Kommunikationen über Wide Area Networks (WAN) realisiert werden.

#### CP 1473 MAP communications processor

The CP 1473 MAP communications processor is used for connecting the

- S5-115U/H,
- S5-135U and
- S5-155U/H

programmable controllers to the international standard MAP 3.0 Ethernet network.

4

#### Design

##### CP 1430 TF/1430 TCP communications processor

Two versions of the CP 1430 TF communications processor are available:

- **CP 1430 TF Basic** for using the SEND/RECEIVE interface or few TF connections; up to 64 ISO transport connections (for SEND/RECEIVE) or up to 16 TF connections.
- **CP 1430 TF Extended** for high-end applications, many TF connections and high real-time accuracy (1 ms), up to 100 TF connections or up to 100 ISO transport connections (for SEND/RECEIVE).

The CP 1430 TF and CP 1430 TCP communications processor have the following interfaces:

- 15-pin sub D socket (push-locking) for connection to Industrial Ethernet; switchable to AUJ or Industrial Twisted Pair
- 15-pin sub D socket (screw-locking) for connection to programming devices.

Operator controls and indicators on the front panel:

- "RUN" - "STOP" switch
- LEDs for indicating the "STOP", "RUN", "FAULT" and "15 V" states

The module requires one slot.

##### CP 1473 MAP communications processor

The communications processor has two interfaces:

- 25-pin sub D socket for connection of the PG 720, PG 720 C, PG 740 and PG 760 programming devices
- 15-pin sub D socket for connection to Industrial Ethernet

Operator controls and indicators on the front panel:

- "RUN" - "STOP" switch
- "RESET" pushbutton
- LEDs for indicating the "STOP" and "RUN" states

The module requires two slots.

#### Principle of operation

The CP 1430 TF, the CP 1430 TCP and CP 1473 MAP handle data communications with the entire network completely autonomously. All layers of the ISO 7-layer reference model are implemented. The communications processors therefore relieve the programmable controller of a large proportion of communications tasks.

The CP 1473 MAP is programmed using the COM 1473 parameterization software with operator prompting. The CP 1430 TF and the CP 1430 TCP is programmed using the COM 1430 TF or COM 1430 TCP parameterization software. Standard function blocks for the user program are available for data interchange with the CPU (see Section 7).

#### Programming

The PG 720, PG 720 C, PG 740 and PG 760 programming devices can be connected directly to the Industrial Ethernet. In this way, all programmable controllers

can be programmed remotely. Using the programming device multiplexer (see Section 8), several modules can be programmed via one interface.

See Section 10 as well as Catalog IK 10 for further details of the Industrial Ethernet LAN as well as of PC modules.

# SIMATIC S5-135U, S5-155U/H

## Communications modules

### CP 1430 TF/CP 1430 TCP/CP 1473 MAP communications processors; Industrial Ethernet (continued)

Technical specifications	
<b>Industrial Ethernet electrical</b>	
Topology	Bus structure
Transmission medium	Triaxial cable 50 ohms
Transmission rate	10 Mbit/s
Transmission mode	Bit-serial
Max. distance between 2 random terminals	0.5 km (0.3 miles) without repeater 1.8 km (1.1 miles) with 2 repeaters 3 km (1.8 miles) with 4 repeaters and 2 x 500 m (1640 ft) fiber optic cable
Max. number of nodes	100 nodes per segment 1024 nodes for the whole network
Allocation method	CSMA/CD in acc. with IEEE 802.3 (Ethernet)
<b>Industrial Ethernet fiber optic</b>	
Topology	Star structure
Transmission medium	Fiber optic cable, fiber 62.5/125 μm
Transmission rate	10 Mbit/s
Transmission mode	Bit-serial
Max. distance between 2 random terminals	Max. 4.6 km (2.7 miles) with 1 active star coupler
Max. number of nodes	1024 nodes for the whole network
Allocation method	CSMA/CD in acc. with IEEE 802.3 (Ethernet)
<b>CP 1430 TF/CP 1430 TCP/CP 1473 MAP communications processors</b>	
Current consumption	
• CP 1430 TF/CP 1430 TCP without transceiver at 5 V	max. 1.7 A
• CP 1430 TF/CP 1430 TCP with transceiver at 5 V	max. 3.2 A
• CP 1430 TF/CP 1430 TCP with transceiver at 24 V	max. 100 mA
• CP 1473 with 15 V module at 5 V	max. 4.2 A (2.6 A without transceiver load)
Space requirements	
• CP 1430 TF with transceiver	1 slot
• CP 1473 MAP	2 slots
Weight	
• CP 1430 TF/CP 1430 TCP	approx. 0.7 kg (1.54 lb)
• CP 1473 MAP	approx. 0.85 kg (1.87 lb)
<b>Transceiver</b>	
Supply voltage	9 to 15 V DC
Current consumption	250 mA (with 1 interface) 490 mA (with 2 interfaces)
Connectors	
• For connection to Industrial Ethernet	SINEC bus connector with coaxial socket
• For connection to terminal	15-pin sub D plug
Dimensions (W x H x D) in mm (in)	180 x 85 x 45 (6.92 x 3.26 x 1.73)
Weight	approx. 0.64 kg (1.4 lb)
<b>Repeater</b>	
Supply voltage	120/220 V AC
Current consumption min. max.	on request
Dimensions (W x H x D) in mm	on request
Weight	approx. on request
<b>SSV 104 fan-out unit</b>	
Supply voltage	100 to 240 V AC
Power input	40 W
Dimensions (W x H x D) in mm	432 x 46 x 252
Weight (of desktop unit)	approx. 2.1 kg (4.62 lb)

## SIMATIC S5-135U, S5-155U/H

## Communications modules

## CP 1430 TF/CP 1473 MAP communications processors; Industrial Ethernet (continued)

Ordering data	Order No.	Ordering data	Order No.
<b>Communications processor</b> • CP 1430 TF Basic	<b>6GK1 143-0TA02</b>	<b>Bus transceiver w/ 2 interfaces for Industrial Ethernet</b> lets you connect two terminals to Industrial Ethernet, incl. assembly instructions in German, English, French	<b>6GK1 901-0AA00-0AC0</b>
• CP 1430 TF Extended	<b>6GK1 143-0TB01</b>		
<b>COM 1430 TF parameter assignment software</b>	see Section 7		
<b>CP 1430 TF/COM 1430 TF manual</b> German	<b>6GK1 970-1TA43-0AA0</b>	<b>SIBUKO transceiver package 2 for Industrial Ethernet</b> consisting of: 1 tapping mechanism, 1 transceiver, 2 dust protectors for transceiver, 1 mounting plate for transceiver, 1 permanent mounting set for transceiver cable, 1 instruction (German, English, French)	<b>6GK1 100-0AB00</b>
English	<b>6GK1 970-1TA43-0AA1</b>		
French	<b>6GK1 970-1TA43-0AA2</b>		
Italian	<b>6GK1 970-1TA43-0AA4</b>		
<b>CP 1430 TCP communications processor</b>	<b>2XV9 450-1AU00</b>		
<b>COM 1430 TCP parameter assignment software</b>	see Section 7		
<b>CP 1430 TCP/COM 1430 TCP manual</b> German	<b>2XV9 450-1AU03</b>	<b>Terminating resistors (2)</b> for Industrial Ethernet	<b>6ES5 755-3AA11</b>
English	<b>2XV9 450-1AU02</b>		
<b>CP 1473 MAP communications processor</b>	<b>6GK1 147-3MA00</b>	<b>Coaxial connector</b> (N connector; 2) for 727-0 bus cable	<b>6ES5 755-4AA11</b>
<b>COM 1473 TCP parameter assignment software</b> with CP 1473 MAP manual	see Section 7		
<b>CP 1473 MAP manual</b> German	<b>6GK1 970-1MA73-0AA0</b>	<b>Repeater</b>	<b>6ES5 755-1AA12</b>
English	<b>6GK1 970-1MA73-0AA1</b>	<b>SSV 104 fan-out unit</b> for connecting a maximum of 8 nodes to Industrial Ethernet	<b>6GK1 104-0AA00</b>
<b>Connecting cable PG 7xx/CP 1473</b> 2.5 m (8.2 ft)	<b>6XV1 800-6CH25</b>	<b>727-1 connecting cable</b> for connecting transceiver to node	
<b>CP-PLC cable</b> for S5-115U/135U/155U 0.6 m (1.97 ft)	<b>6XV1 800-6FE60</b>	Length	<b>6ES5 727-1BD20</b> <b>6ES5 727-1CB00</b> <b>6ES5 727-1CB50</b> <b>6ES5 727-1CC00</b> <b>6ES5 727-1CD20</b> <b>6ES5 727-1CF00</b> <b>6ES5 727-0AA11</b>
<b>376 memory submodule (EPROM)</b> for CP 1473 MAP 16 Kbyte 32 Kbyte 64 Kbyte	<b>6ES5 376-1AA11</b> <b>6ES5 376-1AA21</b> <b>6ES5 376-1AA31</b>		
<b>Memory card</b> for CP 1430 TF, long format, flash EPROM, 256 Kbyte (16 bit) RAM, 256 Kbyte (16 bit)	<b>6ES5 374-2KH21</b> <b>6ES5 374-2AH21</b>	<b>727-0 bus cable</b> sold by the meter, without connector; length to be specified in m	
<b>Bus transceiver for Industrial Ethernet</b> lets you connect a terminal to Industrial Ethernet, incl. assembly instructions in German, English, French	<b>6GK1 901-0AA00-0AA0</b>	<b>725-0 connecting cable</b> for connecting the CP 1430 TF to the module to be programmed (for remote programming) Length	<b>6ES5 725-0AK00</b> <b>6ES5 725-0BC50</b>
		0.9 m (2.9 ft) 2.5 m (8.2 ft)	

# SIMATIC S5-135U, S5-155U/H

## Central controllers/Expansion units

### 135U/155U central controller

#### Application



The 135U/155U central controller can be used optionally for the construction of a S5-135U, S5-155U or S5-155H programmable controller.

Two 135/155U central controllers are required for a S5-155H programmable controller.

4

#### Design

The 135U/155U central controller comprises:

- 21 free slots
- 1 power supply chassis with built-in fan

#### S5-135U, S5-155U

Depending on the extent of the automation task, the central controller can be equipped with the following CPUs:

- CPU 948 (max. 4)
- CPU 928B (max. 4)
- CPU 928 (max. 4)
- CPU 922 (max. 4)

All CPUs can also operate jointly in multiprocessor mode. When more than one of these central modules is used a 923A/923C coordinator is required (see page 4/30).

#### S5-155H

One CPU 948R can be used per central controller.

#### Power supply chassis

- Redundant two-out-of-three fan concept; Should one fan cease operating the speed of the other fans is increased thus enabling the programmable controller to continue operation. The defective fan can be replaced while the controller is in operation
- Redundant one-out-of-two battery concept; In the case of a failure of the main battery (Li battery) the accu battery switches on automatically for a period of three weeks
- Mains buffering to NAMUR: 20 ms
- Enhanced electromagnetic compatibility (EMC)

# SIMATIC S5-135U, S5-155U/H

## Central controllers/Expansion units

### 135U/155U central controller (continued)

#### Design

##### Possible configurations S5-135U/155U

Note the respective slot requirements of the modules!

	Slot No.	3	11	19	27	35	43	51	59	67	75	83	91	99	107	115	123	131	139	147	155	163	
923 A/C coordinator		■																					
CPU 922, CPU 928A, CPU 928B			■		■		■		■														
CPU 948			■	■	■	■	■	■	■	■													
IM 300-5, IM 301-5 interface modules <sup>2)</sup>																						■	■
IM 300-3, IM 301-3, IM 304, IM 308, IM 308-B interface modules																						■	■
IM 308-C, IM 307 <sup>1)</sup> interface modules																■	■	■	■	■	■	■	■
Digital input modules, digital output modules		■		■	■	■	■	■	■	■	■	■	■	■	■	■	■	■	■	■	■	■	■
Analog input modules, analog output modules		■		■	■	■	■	■	■	■	■	■	■	■	■	■	■	■	■	■	■	■	■
Intelligent I/O modules		For slot assignment, see Section 11																					
Communications processors <sup>3)</sup>		For slot assignment, see Section 11																					
Hardware interrupt processing			■		■		■		■		■	■	■	■	■	■	■	■	■	■	■	■	■
PG MUX function via 923C coordinator		■		■		■		■		■	■	■	■	■	■	■	■	■	■	■	■	■	■
Floating operation		■	■	■	■	■	■	■	■	■	■	■	■	■	■	■	■	■	■	■	■	■	■

1) Jumper selection on the IM 307 must be observed.

Interrupt transfer is only possible on slots 107 to 131.

2) In the case of 135U with Order No. 6ES5 135-3UA42 only slot 163.

3) Note the functions given in the lower half of the table.

##### Possible configurations of the S5-155H

Note the respective slot requirements of the modules!

	Slot No.	3	11	19	27	35	43	51	59	67	75	83	91	99	107	115	123	131	139	147	155	163	
CPU 946R <sup>4)</sup>			■	■																			
Communications processor <sup>6)</sup>		For slot assignment, see Section 11																					
Intelligent I/O modules		For slot assignment, see Section 11																					
IM 301-3, IM 304-3, IM 308-3, IM 308-B interface modules																						■	■
IM 300-5, IM 301-5 interface modules		■																				■	■
IM 304 or IM 342R interface module for linking the central controllers <sup>7)</sup>																	■	■					
Digital input modules <sup>5)</sup> , digital output modules		■		■	■	■	■	■	■	■	■	■	■	■	■	■	■	■	■	■	■	■	■
Analog input modules, analog output modules		■		■	■	■	■	■	■	■	■	■	■	■	■	■	■	■	■	■	■	■	■
IM 308-C, IM 307																■	■	■	■	■	■	■	

4) Occupied slots.

5) Redundant operation of digital input modules is not possible with an input voltage of 115/230 V AC.

6) The space requirements for the separate modules must be taken into account.

7) Subunit A with IM 324R, subunit B with IM 304.

# SIMATIC S5-135U, S5-155U/H

## Central controllers/Expansion units

### 135U/155U central controller (continued)

#### Principle of operation

#### Multiprocessor operation

When using several CPUs, every single one processes the tasks assigned to it independently from the others. Every CPU features its own user program memory, own time and count cells and own bit memories.

In a time sharing process the coordinator assigns the access to the internal S5 bus cyclically to the individual CPUs. Thus, data collision on the bus is prevented.

Additionally, the coordinator is the intermediate memory for the communication of the

CPUs with each other. Two alternatives are available for that:

- The coupling bit memory exchange for small amounts of data supported by the system program of the CPUs
- The multiprocessor communication for large amounts of data

Ordering data	Order No.		Order No.
<b>135U/155U central controller</b> without CPU, without backup battery, with power supply <ul style="list-style-type: none"> <li>• 230/120 V AC, 5 V/18 A, 15 V/0.5 A, 24 V/1 A<sup>1)</sup></li> <li>• 230/120 V AC; 5 V/40 A, 15 V/2 A, 24 V/2.8 A</li> <li>• 24 V DC; 5 V/18 A, 15 V/0.5 A, 24 V/1 A</li> <li>• 24 V DC; 5 V/40 A, 15 V/2 A, 24 V/2.8 A<sup>1)</sup></li> </ul>	<b>6ES5 188-3UA12</b>	<b>Backup battery</b> (lithium battery) To be ordered as a separate item: <b>S5-135U/155U system manual</b>  <b>Additional manuals</b>  <b>Replaceable fan</b>  <b>Accessories, spare parts</b>	<b>6EW1 000-7AA</b>
	<b>6ES5 188-3UA22</b>		see page 4/155
	<b>6ES5 188-3UA32</b>		see page 4/155
	<b>6ES5 188-3UA52</b>		<b>6ES5 988-3NB41</b>
	<b>6ES5 135-3UA42</b>		see page 4/155
<b>135U central controller</b> without CPU, without backup battery <ul style="list-style-type: none"> <li>• 24 V DC; 5 V/10 A</li> </ul>			

1) Also for S5-155H

# SIMATIC S5-135U, S5-155U/H

## Central controllers/Expansion units

### 155H central controller

#### Application

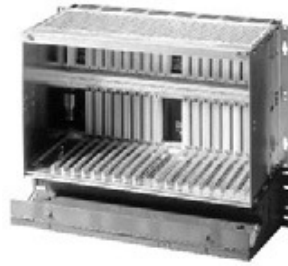

The ZG155H central controller is suitable for building a complete S5-155H programmable controller in a module sub-rack.

4

#### Design

The central controller 155H is a module subrack divided into two halves. It has

- 10 slots (left half)
- 11 slots (right half)

Of these slots two each are used for the power supply, two for the CPU and one for the IM 324R/IM 304.

Five (left half) or six (right half) free slots are therefore available.

The 155H is supplied with two 24V DC; 5V,14A power supplies and a fan subassembly.

One or two backup batteries per power supply can also be ordered to back up the CPU (redundant backup).

#### Possible configurations of S5-155H (redundant configuration)

Pay attention to the number of slots required!

Slot	3	11	19	27	35	43	51	59	67	75	83	91	99	107	115	123	131	139	147	155	163	
Power supplies	■	■									■	■										
CPU 948R/RL			■	■									■	■								
Communications processor						■	■	■	■	■							■	■	■	■	■	■
Signal preprocessing modules						■	■	■	■	■							■	■	■	■	■	■
Interface modules IM 304, IM 324 R					■	■										■	■					
Interface module IM 304								■	■	■										■	■	■
Interface module IM 308						■	■	■	■	■							■	■	■	■	■	■
Digital inputs/outputs						■	■	■	■	■							■	■	■	■	■	■
Analog inputs/outputs						■	■	■	■	■							■	■	■	■	■	■

Ordering data	Order No.		Order No.
<b>155H central controller</b> without CPU; without backup battery, with two power supplies 24 V DC; 5 V/14 A	<b>6ES5 188-3UH31</b>	To be ordered as a separate item:	
<b>Backup battery</b>	<b>6ES7 971-0BA00</b>	<b>S5-155H manual</b> (with description of the 155H)	see Page 4/155
		<b>Other manuals</b>	see Page 4/155
		<b>Accessories, parts</b>	see Page 4/155

# SIMATIC S5-135U, S5-155U/H

## Central controllers/Expansion units

### 183U expansion unit

#### Application



The 183U expansion unit is designed for centralized and distributed connection to central controllers. It is also suitable for the centralized connection to distributed expansion units for S5-135U and S5-155U.

#### Design

The 183U expansion unit comprises:

- 21 free slots
- 1 built-in power supply chassis with fans

The 183U can be centrally connected to the central

controller or to other expansion units with the IM 312 interface module. In addition the 183U can be connected distributed to central controllers with the IM 310, IM 314, IM 317 and IM 318 interface modules.

A hardware interrupt is not possible in the 183U expansion unit. No battery backup is provided for the RAM.

#### Possible configurations

Note the respective slot requirements of the modules!

Slot No.	3	11	19	27	35	43	51	59	67	75	83	91	99	107	115	123	131	139	147	155	163	
IM 300 interface module																						
IM 310, IM 314, IM 317 or IM 318 interface modules																						
IM 312-3 interface module																						
Digital input modules, digital output modules																						
Analog input modules, analog output modules																						
Intelligent I/O modules	For slot assignment, see Section 11																					
313 monitoring module																						

Ordering data	Order No.	Order No.
<b>183U expansion unit</b> with power supply • 230/120 V AC; 5 V/18 A, 15 V/0.5 A, 24 V/1 A • 24 V DC; 5 V/18 A, 15 V/0.5 A, 24 V/1 A	<b>6ES5 183-3UA13</b>  <b>6ES5 183-3UA22</b>	To be ordered as a separate item: <b>S5-135U/155U system manual</b>  <b>Additional manuals</b>  <b>Accessories, spare parts</b>
		see page 4/155 see page 4/155 see page 4/155



# SIMATIC S5-135U, S5-155U/H

## Central controllers/Expansion units

### 184U expansion unit

#### Application



The 184U expansion unit is designed for the centralized connection to central controllers and expansion units with power supply chassis for S5-135U and S5-155U.

4

#### Design

The 184U expansion unit comprises:

- 21 free slots
- 1 fan subassembly

The 184U can be centrally connected to the central controller or to other expansion units by using the IM 312 interface module.

A power supply chassis is not required because the expansion unit is supplied via the connecting cable for the IM 312-5 interface module.

A hardware interrupt is not possible in the expansion unit. Modules with RAM backup cannot be implemented because there is no battery backup for the supply voltage.

#### Possible configurations

Note the respective slot requirements of the modules!

	Slot No.	3	11	19	27	35	43	51	59	67	75	83	91	99	107	115	123	131	139	147	155	163	
IM 312-5 interface module																							
Digital input modules, digital output modules																							
Analog input modules, analog output modules																							
Intelligent I/O modules		For slot assignment, see Section 11																					
313 monitoring module																							

Ordering data	Order No.	Order No.
<b>184U expansion unit</b> without power supply • With 230/120 V AC fan • With 24 V DC fan	<b>6ES5 184-3UA11</b> <b>6ES5 184-3UA21</b>	To be ordered as a separate item: <b>S5-135U/155U system manual</b> see page 4/155 <b>Additional manuals</b> see page 4/155 <b>Accessories, spare parts</b> see page 4/155

# SIMATIC S5-135U, S5-155U/H

## Central controllers/Expansion units

### EG 185U expansion unit

#### Application



The EG 185U expansion unit is suitable for the distributed connection to central controllers and other expansion units S5-135U/155U. In addition, the EG 185U makes switched I/O design possible in the case of the fault-tolerant S5-155H programmable controller.

4

#### Design

The EG 185U expansion unit comprises:

- 21 free slots
- 1 built-in power supply chassis with fans

The EG 185U can be connected distributed to central controllers or other expansion

units with the IM 314, IM 317 and IM 318 interface modules.

All intelligent I/O modules (IP) and communications processors (CP) can be connected in the EG 185U.

Up to 8 communications processors can be programmed via an interface if a 923C coordinator is used.

A hardware interrupt is not possible in the EG 185U expansion unit. A backup battery is provided for the RAM.

#### Possible configurations when connected to S5-135U, S5-155U

Note the respective slot requirements of the modules!

	Slot No.	3	11	19	27	35	43	51	59	67	75	83	91	99	107	115	123	131	139	147	155	163	
923 C coordinator																							
IM 300-5 interface module																							
IM 314, IM 317 or IM 318 interface modules																							
IM 308-A interface module																							
Digital input modules, digital output modules																							
Analog input modules, analog output modules																							
Intelligent I/O modules		For slot assignment, see Section 11																					
Communications processors		For slot assignment, see Section 11																					
IM 314R interface module (for the S5-155H)																							
313 monitoring module																							

# SIMATIC S5-135U, S5-155U/H

## Central controllers/Expansion units

### 185U expansion unit (continued)

#### Design (continued)

Possible configurations when connected to S5-155H

Note the respective slot requirements of the modules!

	Slot No.	3	11	19	27	35	43	51	59	67	75	83	91	99	107	115	123	131	139	147	155	163	
IM 300-5C, IM 308 interface modules; 313 monitoring module																							
IM 314R interface module																							
Digital input modules, digital output modules																							
Analog input modules, analog output modules																							
Intelligent I/O modules	For slot assignment, see Section 11																						
Communications processors	For slot assignment, see Section 11																						
IM 308-C interface modules <sup>1)</sup>																							

1) Operation in EU only in combination with S5-155H

#### Ordering data

Order No.

Order No.

##### 185U expansion unit

- with power supply,  
without backup battery
- 230/120V AC; 5V/18A,  
15V/0.5A, 24V/1A
  - 230/120V AC; 5V/40A, 15V/2A,  
24V/2.8A
  - 24V DC; 5V/18A, 15V/0.5A,  
24V/1A
  - 24V DC; 5V/40A, 15V/2A,  
24V/2.8A

**6ES5 185-3UA13**

**6ES5 185-3UA33**

**6ES5 185-3UA23**

**6ES5 185-3UA43**

##### Backup battery (lithium battery)

**6EW1 000-7AA**

To be ordered as a separate item:

**S5-135U/155U system manual**

**Additional manuals**

**Accessories, spare parts**

see page 4/155

see page 4/155

see page 4/155

# SIMATIC S5-135U, S5-155U/H

## Central controllers/Expansion units

### 187U expansion unit

#### Application



The 187U expansion unit is designed for the centralized connection to central controllers and expansion units with power supply chassis for S5-135U and S5-155U.

#### Design

The 187U expansion unit comprises:

- 11 free slots

A power supply chassis, fan and wiring duct are not available.

The 187U expansion unit can be centrally connected to central controllers or other expansion units with the IM 312 interface module.

The power supply is delivered by the connecting cable of the IM 312-5 interface module.

A hardware alarm is not possible in the 187U expansion unit. No battery backup is provided for the RAM.

4

#### Possible configurations

Note the respective slot requirements of the modules!

	Slot No.	3	11	19	27	35	43	51	59	67	75	83	91	99	107	115	123	131	139	147	155	163	
IM 312-5 interface module																							
Digital input modules, digital output modules																							
Analog input modules, analog output modules																							
313 monitoring module																							

#### Ordering data

	Order No.		Order No.
<b>187U expansion unit</b>	<b>6ES5 187-5UA11</b>	<b>Additional manuals</b>	see page 4/155
To be ordered as a separate item: <b>S5-135U/155U system manual</b>	see page 4/155	<b>Accessories, spare parts</b>	see page 4/155

## SIMATIC S5-135U, S5-155U/H

## Power supply modules

## Power supply chassis

Technical specifications							
Power supply chassis	6ES5 955	-3LC41	-3LF41	-3LNC41	-3NF41	-3NA12	-7NC11
Installed in		ZG 135U/155U EG 183U EG185U	ZG 135U/155U EG 185U	ZG 135U/155U EG 183U EG 185U	ZG 135U/155U EG 185U	ZG 135U	ZG 155H
<b>Input voltage</b>		<b>230 V/120 V AC</b>		<b>24 V DC</b>	<b>24 V DC</b>	<b>24 V DC</b>	<b>DC 24 V</b>
• Rated value		187 to 264 V/93 to 132 V		18 to 33 V	18 to 33 V	20 to 30 V	18 to 33 V
• Permissible range (including ripple)							
Line frequency		50 Hz					
• Rated value		47 to 63 Hz					
• Permissible range							
Input current		1.5 A (230 V)/ 2.5 A (120 V)		9.5 A	20 A	4.8 A	14 A
• Rated value		2.6 A (230 V)/ 4.5 A (120 V)					
• Inrush current max.		26 A for 100 µs	25 A for 2 ms	100 A for 100 µs	200 A for 1 ms	100 A	100 A
I <sup>2</sup> · t value of inrush current		4 A <sup>2</sup> s	5.2 A <sup>2</sup> s	2,7 A <sup>2</sup> s	18 A <sup>2</sup> s	20 A <sup>2</sup> s	2.7 A <sup>2</sup> s
Stored energy time in the event of power failure		20 ms	20 ms	20 ms	20 ms	5 ms	5/20 ms (settable)
Message via separate floating contacts		Fan failure (1 fan), Fan failure (2 or 3 fans), Battery failure				Fan failure, Battery failure	Fan failure, Battery failure
<b>Number of outputs</b>		3 (outputs A1/A2/A3)				2	2
<b>Output voltage (A1/A2/A3)</b>		5.1 V DC/24V DC/15 V DC				5.1 V DC/24 V DC	5.1 V DC/24V DC
• Rated value		± 0.5 %/(+ 25 %, -12.5 %)/ ± 5 %				DC	- 0.5 %, + 2%
• Tolerance						± 0.5 % (+ 25 %, - 24 %)	(+ 25%, -12.5%)
Output current (A1/A2/A3)		18 A/1 A/0.5 A		18 A/1 A/0.5 A	40 A/2.8 A/2 A	10 A/0.4 A	14 A/0,1 A
• Rated value		40 A/2.8 A/2 A					
• Permissible range		0.5 to 18 A	1.6 to 40 A	0.5 to 18 A	1.6 to 40 A	0 to 10 A	0.2 to 14 A
Galvanic isolation		Yes				No	Yes
Main buffering		Li battery (3.6 V; 5 Ah)				Li battery (3.6 V; 5 Ah)	Li battery (3.6 V; 1.9 Ah)
Reserve buffering		Accumulator (3.6 V; 1.2 Ah)				-	Li battery (3.6 V; 1.9 Ah)
Input for monitoring the load voltage 24 V		Yes				No	No
Auxiliary voltage		0.5 A		0.5 A	2 A	—	—
• 15 V ± 0.5 %		2 A					
• 24 V + 25 %/- 12.5 %		1 A	2.8 A	1 A	2.8 A	0.4 A	1 A
Power loss max.		80 W	147 W	90 W	153 W	50 W	50 W
Number of integrated fans		3 (2-out-of-3 fan concept; fans can be exchanged during operation)				2	—
Weight approx.		5.8 kg (12.7 lb)				3.8 kg (8.4 lb)	1.3 kg (2.9 lb)
<b>15 V submodule</b>		<b>6ES5 956-0AA12 (for power supply only 6ES5 955-3NA12)</b>					
Can be installed in		Power supply chassis					
Input voltage		24 V auxiliary voltage of the power supply chassis					
Input current approx.		Equal to output current					
<b>Output voltage</b>		+ 15 V					
• Rated value		± 0.5 %					
• Tolerance		0.5 A					
Output current max.		0.2 kg (0.4 lb)					
Weight approx.							

Note:

The power supply units can be switched from 230 V to 120 V supply voltage. 5 V and 15 V output voltages are stabilized, the 24 V output voltage is roughly stabilized.

# SIMATIC S5-135U, S5-155U/H

## Power supply modules

### SITOP load power supplies

#### Application

The SITOP power family of power supplies is designed for supplying electrical consumers such as actuators or transmitters. The SITOP power family offers a uniform range of regulated power supplies, from 2 A to 40 A, for every application.

The 24 V power supplies of the SITOP family have the following characteristics:

- High efficiency, up to 90%
- Easy mounting on standard rails or on a mounting plate
- Low space requirements
- Accurate output voltage

- Minimal residual ripple
- Integrated short-circuit protection
- Safe electrical isolation
- Compliance with national and international standards

#### SITOP power basic line



The SITOP power basic line (24 V/2 A to 40 A) has been specially developed and optimized for industrial use. The units are used as load power supplies and for supplying electronic modules with a narrow input voltage range. It has excellent control characteristics, without the need for optional extras at additional

cost. With no more than the essential functions, these units represent the optimum solution for industrial customers in terms of price and technology.

4

#### SITOP power special line



The SITOP power special line (24 V/5 A to 10 A) is, like the basic line, specially designed for industrial use. The units are particularly suitable for use with distributed I/O (5A, 10 A) and for supplying the ASI bus (2.4 A). The special feature of these units is the extremely narrow and rigid metal case.

It allows installation in applications requiring a low mounting depth, i.e. in machines, tight spaces, U-profiles and switch-boxes at the machine.

#### SITOP power universal line



The units of the SITOP power universal line (24 V / 2.5 A to 4 A) have been developed for applications with demanding technical requirements. Interference suppression to class B guarantees minimal emitted interference. This means that in addition to industrial operation, the units are also suitable for domestic use, i.e. in building services automation.

For the basic technical specifications, see the following page.

## SIMATIC S5-135U, S5-155U/H

## Power supply modules

## SITOP load power supplies (continued)

Technical specifications			
Equipment series	basic line	special line	universal line
Rated supply voltage	SITOP power 24 V/2 to 40 A 120/230 V AC to 3 400 V AC	SITOP power 24 V/5 to 10 A 120/230 V AC	SITOP power 24 V/2.5 to 4 A 120/230 V AC
Stored energy time in the event of power failure	> 20 ms; > 3 ms	> 20 ms	> 20 /30 ms (at 120/187 V)
Line frequency			
• Rated value	50/60 Hz	50/60 Hz	50/60 Hz
• Permissible range	47 to 63 Hz	47 to 63 Hz	47 to 63 Hz
Output voltage			
• Rated value	24 V DC	24 V DC	24 V DC
• Tolerance	± 3%; ±1%	± 3%	± 1%
• Residual ripple	< 150 mV	< 150 mV	< 50 mV
Efficiency, approx.	83 % to 89 %	87 % to 89 %	> 85 %
Line frequency			
• Rated value	50 Hz		
• Permissible range	47 to 63 Hz		
Output current			
• Rated value	2 to 40 A	5 to 10 A	2.5 to 4 A
• Range	0 to 40 A	0 to 10 A	0 to 4 A (up to 50 °C)
Short-circuit protection	Electronic	Electronic	Electronic
Degree of protection (IEC 536)	Class I	Class I	Class I
Galvanic isolation (SELV in acc. with EN 60950)	Yes	Yes	Yes
Radio interference suppression	Class A	Class A (EN 55011)	Class B (VDE 0871)
Degree of protection (IEC 529)	IP 20 and IP 00	IP 20	IP 20
Ambient temperature	0 to + 60 °C	0 to + 60 °C	0 to + 60 °C
Weight	0.5 to 7 kg	0.7 to 1.2 kg	0.5 kg

Ordering data	Order No.	Order No.
<b>Power supply SITOP power basic line</b>		<b>Power supply SITOP power universal line</b>
Single-phase, 24 V/2 A	<b>6EP1 331-1SL11</b>	Single-phase, 24 V/2.5 A
Single-phase, 24 V/5 A	<b>6EP1 333-1SL11</b>	Single-phase, 24 V/4 A
Single-phase, 24 V/10 A	<b>6EP1 334-1SL11</b>	Single-phase, 24 V/20 A
3-phase, 24 V/20 A	<b>6EP1 436-1SL11</b>	3-phase (500 V), 24 V/20 A
3-phase, 24 V/40 A	<b>6EP1 437-1SL11</b>	
<b>Power supply SITOP power special line</b>		
Single-phase, 24 V/5 A	<b>6EP1 333-1AL11</b>	
Single-phase, 24 V/10 A	<b>6EP1 334-1AL11</b>	
DC/DC, 30 V/2.4 A	<b>6EP1 632-1AL01</b>	

Further information can be found in the catalog for systems engineering KT 10.

# SIMATIC S5-135U, S5-155U/H

## Interface modules

### Overview

#### Overview

The following overview shows the interface modules and connecting cables used to connect the various expansion units to the central controllers.

Configuration/ transmission mode	Central controller		Expansion unit			Connecting cable
	Programmable controller type	Interface module type	EU type for S5-135U, S5-155U/H	ER type for S5-115U/H/F	Interface module type	Type Length
Centralized up to 2 m (6.5 ft), asymmetrical	S5-135U S5-155U S5-155H <sup>1)</sup> ,	<b>IM 300-3</b>	EU 183U	—	<b>IM 312-3</b>	0.5 m <sup>2)</sup> 0.95 m <sup>2)</sup>
		<b>IM 300-5</b> (-5CA1 <sup>1)</sup> )	EU 184U EU 187U	—	<b>IM 312-5</b>	0.5 m <sup>2)</sup> 1.5 m <sup>2)</sup>
		<b>IM 300-5</b> (-5LB1 <sup>1)</sup> )	—	ER 701-1	<b>IM 306</b>	705-0/ 0.5 ... 2.5 m
		<b>IM 301-3</b>	EU 183U	—	<b>IM 312-3</b>	0.5 m <sup>2)</sup> 0.95 m <sup>2)</sup>
		<b>IM 301-5</b>	EU 184U EU 187U	—	<b>IM 312-5</b>	0.5 m <sup>2)</sup> 1.5 m <sup>2)</sup>
Centralized and distributed up to 100 m (328 ft), symmetrical	S5-135U S5-155U S5-155H <sup>1)</sup> ,	<b>IM 301-3</b>	EU 183U	—	<b>IM 312-3</b>	0.5 m <sup>2)</sup> 0.5 m <sup>2)</sup>
		<b>IM 301-3</b>	EU 183U	ER 701-2 ER 701-3	<b>IM 310</b>	705-0/ 1 ... 100 m
		<b>IM 301-5</b>	EU 184U EU 187U	—	<b>IM 312-5</b>	0.5 m <sup>2)</sup> 1.5 m <sup>2)</sup>
Distributed up to 500 m (1640 ft), symmetrical	S5-135U S5-155U S5-155H <sup>1)</sup> , S5-155H <sup>3)</sup>	<b>IM 304</b>	EU 183U EU 185U	ER 701-2 ER 701-3	<b>IM 314</b>	721-0/ 1 ... 500 m
			EU 185U	ER 701-3H	<b>IM 314R</b>	721-0/ 1 ... 500 m
Distributed up to 3000 m (9840 ft), serial electrical	S5-135U S5-155U S5-155H <sup>1)</sup> ,	<b>IM 308</b>	EU 183U EU 185U	ER 701-2 ER 701-3	<b>IM 318-3</b>	Shielded, twisted 2-wire cable
Distributed 50 ... 1500 m (164 ... 4920 ft) (each between 2 interface modules), serial optical	S5-135U S5-155U S5-155H <sup>1)</sup> ,		ET 100U	—	<b>IM 318-8</b>	
		<b>IM 307</b>	EU 183U EU 185U	ER 701-2 ER 701-3	<b>IM 317</b> <b>IM 307</b> (IM 307 not in ER 701-2)	722-2 (fiber optic cable)

1) S5-155H with two-channel I/O modules (fully redundant configuration) or single-channel/single-sided I/O configuration.

2) At its one end, the cable is permanently connected to IM 312, at the other end it is provided with a plug connector for connection to IM 300-, or IM 301-.

3) S5-155H with single-channel I/Os (switched).



## SIMATIC S5-135U, S5-155U/H

## Interface modules

## IM 300 and IM 312 interface modules; centralized configuration

## Application



The IM 300/IM 312 interface modules are used for centralized configuration of I/O modules and intelligent I/O modules (without page addressing) with a central controller via the following expansion units:

- EG 183U
- EG 184U
- EG 187U

These expansion units can also be connected in centralized configuration with the EG 183U and EG 185U expansion units.

4

## Design

The IM 300 interface module must be plugged into the slot provided in the central controller. The IM 312 interface module is plugged into the expansion unit. Up to four IM 300 interface modules can be used in the central controller, however, not more than two IM 300-5 in the ZG 135U/155U.

One IM 300 interface module can be plugged into each EG 183U or EG 185U expansion unit.

The IM 300 interface module allows two areas of 256 byte to be configured (P and Q areas).

## Connecting the EG 184U and EG 187U expansion units

(Expansion units without power supply chassis)  
The IM 300-5C interface module is to be used in the central controller and the IM 312-5 interface module in the expansion unit (see Fig. 4/49). Power (5 V, internal) is supplied to the EG 184U and EG 187U expansion units by way of the interface modules.

## Connection of the EG 183U expansion unit

(Expansion unit with power supply chassis) The IM 300-3 interfacemodule is to be used

in the central controller and the IM 312-3 interface module in the expansion unit (see Fig. 4/47). The IM 312-3 and IM 312-5 interface modules cannot be used simultaneously in one chain.

## Connecting additional expansion units

In addition to the aforementioned expansion units, an expansion unit in the ER 701-1 expansion rack of the S5-115U programmable controller can also be connected (see Fig. 4/48). The expansion unit is supplied with power (5 V) by way of the interface module.

## Technical specifications

## Current consumption (at 5 V)

• IM 300	max.	0.6 A
• IM 312	max.	0.2 A

## Power loss

• IM 300	max.	3 W
• IM 312	max.	1 W

## Space requirements

Weight	approx.	0.35 kg (0.77 lb)
--------	---------	-------------------

## Ordering data

## IM 300 interface module

- for the central controller
- For connecting the EG 184U or EG 187U
  - For connecting the EG 183U
  - For connecting the ER 701-0 or ER 701-1

6ES5 300-5CA11

6ES5 300-3AB11

6ES5 300-5LB11

## IM 306 interface module

for the expansion units  
ER 701-0, ER 701-1

6ES5 306-7LA11

## 705 connecting cable

for connecting the IM 300-5LB interface module to the IM 306

Length	0.5 m (1.64 ft)	6ES5 705-0AF00
	1.2 m (3.93 ft)	6ES5 705-0BB20
	1.5 m (4.92 ft)	6ES5 705-0BB50
	2.5 m (8.2 ft)	6ES5 705-0BC50

## IM 312 interface module

- for the expansion units  
EG 184U or EG 187U;
- Expansion unit arranged above the central controller, 0.5 m (1.6 ft) cable
  - Location of expansion unit arbitrary, 1.5 m (4.9 ft) cable
- EG 183U;
- Expansion unit arranged above the central controller, 0.5 m (1.6 ft) cable
  - Expansion unit arranged below the central controller, 0.95 m (3.1 ft) cable

6ES5 312-5CA12

6ES5 312-5CA22

6ES5 312-3AB12

6ES5 312-3AB32

## Terminator for the IM 312-3 interface module

The operating instructions are included in the S5-135U/155U system manual (see page 4/155).

6ES5 760-0AB11

# SIMATIC S5-135U, S5-155U/H Interface modules

## IM 300 and IM 312 interface modules; centralized configuration (continued)

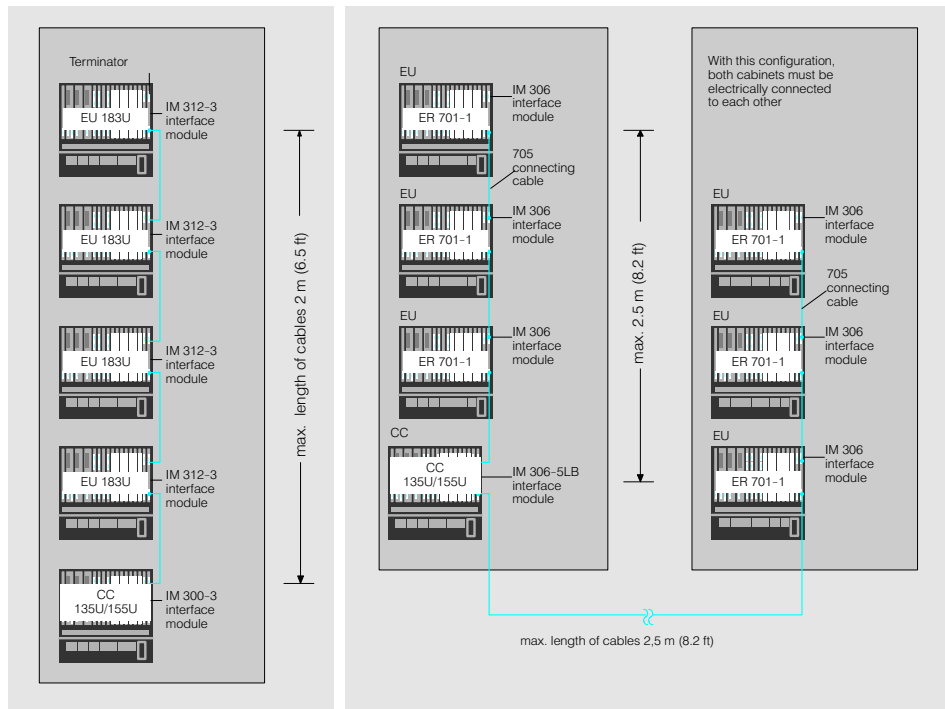

Fig. 4/47 Connection of expansion units **with** power supply chassis to the central controller in centralized configuration using the IM 312-3 and IM 300-3 interface modules

Fig. 4/48 Connection of expansion units **without** power supply chassis to the central controller in centralized configuration using the IM 306 and IM 300-5LB interface modules.

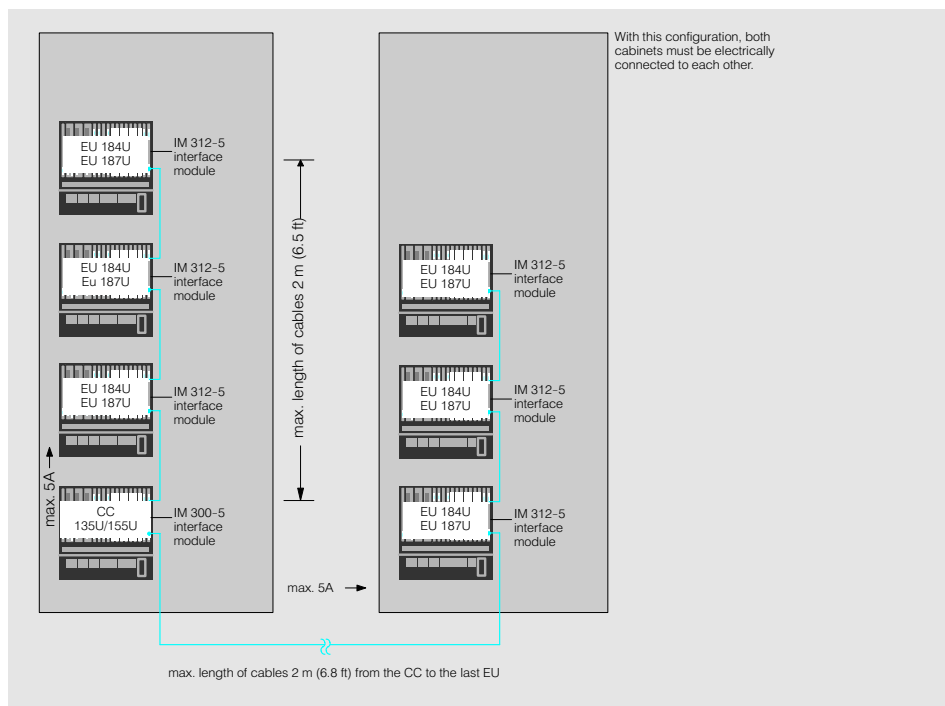

Fig. 4/49 Connection of expansion units **without** power supply chassis to the central controller in centralized configuration using the IM 312-5 and IM 300-5 interface modules.

## SIMATIC S5-135U, S5-155U/H

## Interface modules

## IM 301 and IM 310 interface modules; distributed configuration up to 200 m (656 ft)

## Application

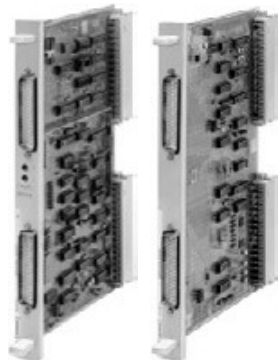

The IM 301/IM 310 interface modules are used for distributed configuration of I/O modules and intelligent I/O modules (without page addressing) with a central controller via the EG 183U expansion unit. The expansion unit can be up to 200 m (656 ft) away from the central controller.

4

## Design

The IM 301 interface module is plugged into the central controller and the IM 310 interface module into the expansion unit. Additional expansion units can be connected in centralized configuration to the distributed EG 183U expansion units. Up to four IM 301 interface modules can be plugged into the central controller.

The IM 301-5 interface module is used if additional EG 184U or EG 187U expansion units are to be connected in a centralized configuration to the central controller.

The IM 301-3 interface module is used if additional EG 183U expansion units are to be connected in a centralized configuration to the central controller.

Terminators must always be inserted into the last IM 310 and into the unused central connectors of the IM 301-3 and the unused distributed connectors of the IM 301-3 and IM 301-5.

The IM 301 interface module allows two areas of 256 byte to be configured (CP and Q areas).

## Technical specifications

## Current consumption (at 5 V)

• IM 301	max.	0.8 A
• IM 310	max.	0.7 A

## Power loss

• IM 301	max.	4 W
• IM 310	max.	3.5 W

## Space requirements

Weight	approx.	1 slot 0.3 kg (0.66 lb)
--------	---------	----------------------------

## Ordering data

## IM 301 interface module

for the central controller

- For the connection of the EG 184U or EG 187U
- For the connection of the EG 183U

## Terminator for the IM 301

- For free distributed connection of IM 301-3 and IM 301-5 (bottom)
- For free centralized connection of IM 301-3 (top)

## IM 310 interface module

for the expansion unit

## Terminator for the IM 310

The operating instructions are included in the S5-135U/155U system manual (see page 4/155).

## Order No.

6ES5 301-5CA12

6ES5 301-3AB13

6ES5 760-0AA11

6ES5 760-0AB11

6ES5 310-3AB11

6ES5 760-0AA11

## 721 connecting cable

1.00 m (3.28 ft)

1.60 m (5.20 ft)

2.00 m (6.56 ft)

2.50 m (8.20 ft)

3.20 m (10.4 ft)

5.00 m (16.4 ft)

8.00 m (26.2 ft)

10.00 m (32.8 ft)

12.00 m (39.3 ft)

16.00 m (52.4 ft)

20.00 m (65.6 ft)

25.00 m (82.0 ft)

32.00 m (104.9 ft)

40.00 m (131.2 ft)

50.00 m (164.0 ft)

63.00 m (206.6 ft)

80.00 m (262.4 ft)

100.00 m (328.0 ft)

500.00 m (1640 ft)

## Order No.

6ES5 721-0 BB00

6ES5 721-0 BB60

6ES5 721-0 BC00

6ES5 721-0 BC50

6ES5 721-0 BD20

6ES5 721-0 BF00

6ES5 721-0 BJ00

6ES5 721-0 CB00

6ES5 721-0 CB20

6ES5 721-0 CB60

6ES5 721-0 CC00

6ES5 721-0 CC50

6ES5 721-0 CD20

6ES5 721-0 CE00

6ES5 721-0 CF00

6ES5 721-0 CG30

6ES5 721-0 CJ00

6ES5 721-0 DB00

6ES5 721-0 DF00

# SIMATIC S5-135U, S5-155U/H

## Interface modules

### IM 301 and IM 310 interface modules; distributed configuration up to 200 m (656 ft) (continued)

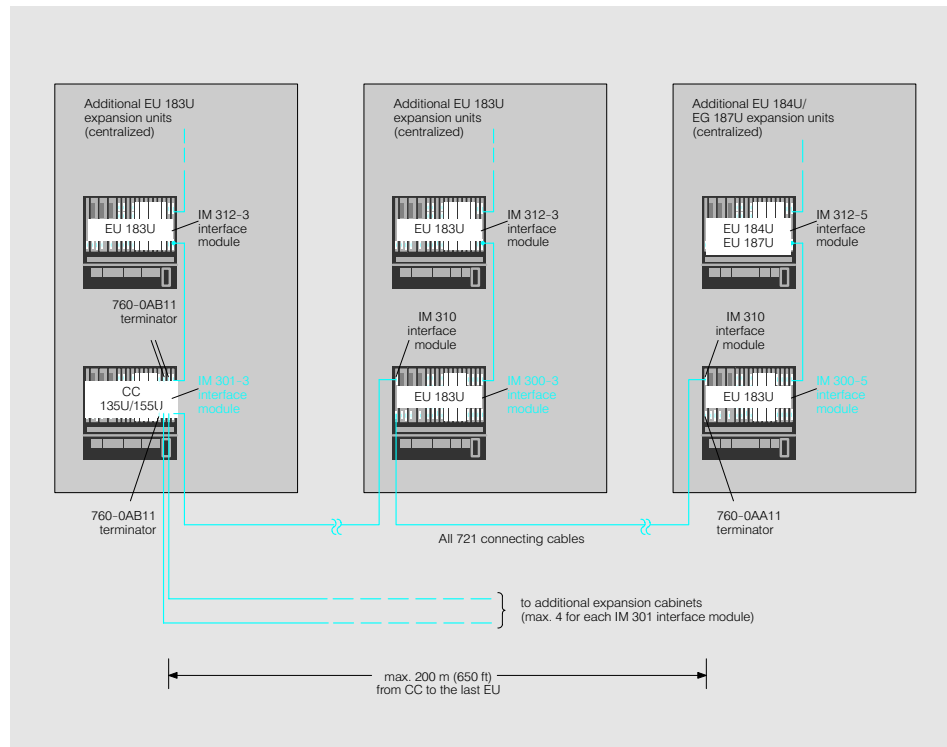

4

Fig. 4/50 Distributed connection of EG 183U expansion units to the central controller via the IM 310 and IM 301-3 interface modules

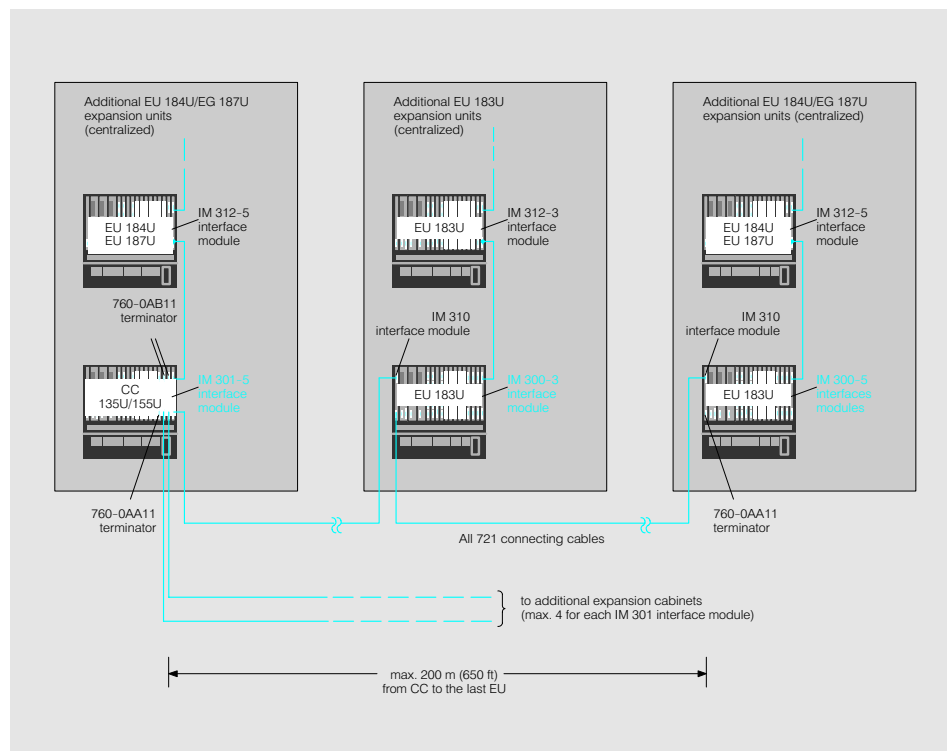

Fig. 4/51 Distributed connection of EG 184U/187U expansion units to the central controller via the IM 310 and IM 301-5 interface modules

## SIMATIC S5-135U, S5-155U/H

## Interface modules

**IM 304 and IM 314 interface modules; distributed configuration up to 600 m (1969 ft)****Application**

The IM 304/IM 314 interface modules are used for distributed configuration of I/O modules, intelligent I/O modules and communications processors with a central controller via the following expansion units:

- EG 183U
- EG 185U

The expansion unit can be up to 600 m (1969 ft) away from the central controller.

4

**Design**

The IM 304 interface module is plugged into the central controller and the IM 314 interface module into the expansion unit. Additional expansion units can be connected in a centralized configuration to the distributed expansion units. Up to four IM 304 interface modules can be plugged into the central controller.

Terminators must always be inserted into the last IM 314 interface module.

The IM 314 interface module allows four areas of 256 byte to be configured (P, Q, IM 3 and IM 4 areas). The IM 3 and IM 4 areas can only be accessed via absolute addresses.

**Technical specifications**

## Current consumption (at 5 V)

• IM 304	max.	1.2 A
• IM 314	max.	1.0 A

## Power loss

• IM 304	max.	6 W
• IM 314	max.	5 W

Number of units connectable to one IM 304

4

Space requirements

1 slot

Weight approx.

0.3 kg (0.66 lb)

**Ordering data**

Order No.

Order No.

**IM 304 interface module**  
for the central controller

**6ES5 304-3UB11****721 connecting cable**

see page 4/142

**IM 314 interface module**  
for the expansion unit

**6ES5 314-3UA11**

**Terminator for the IM 314**

**6ES5 760-1AA11**

The operating instructions are included in the S5-135U/155U system manual (see page 4/155).

# SIMATIC S5-135U, S5-155U/H

## Interface modules

### IM 304 and IM 314 interface modules; distributed configuration up to 600 m (1969 ft) (continued)

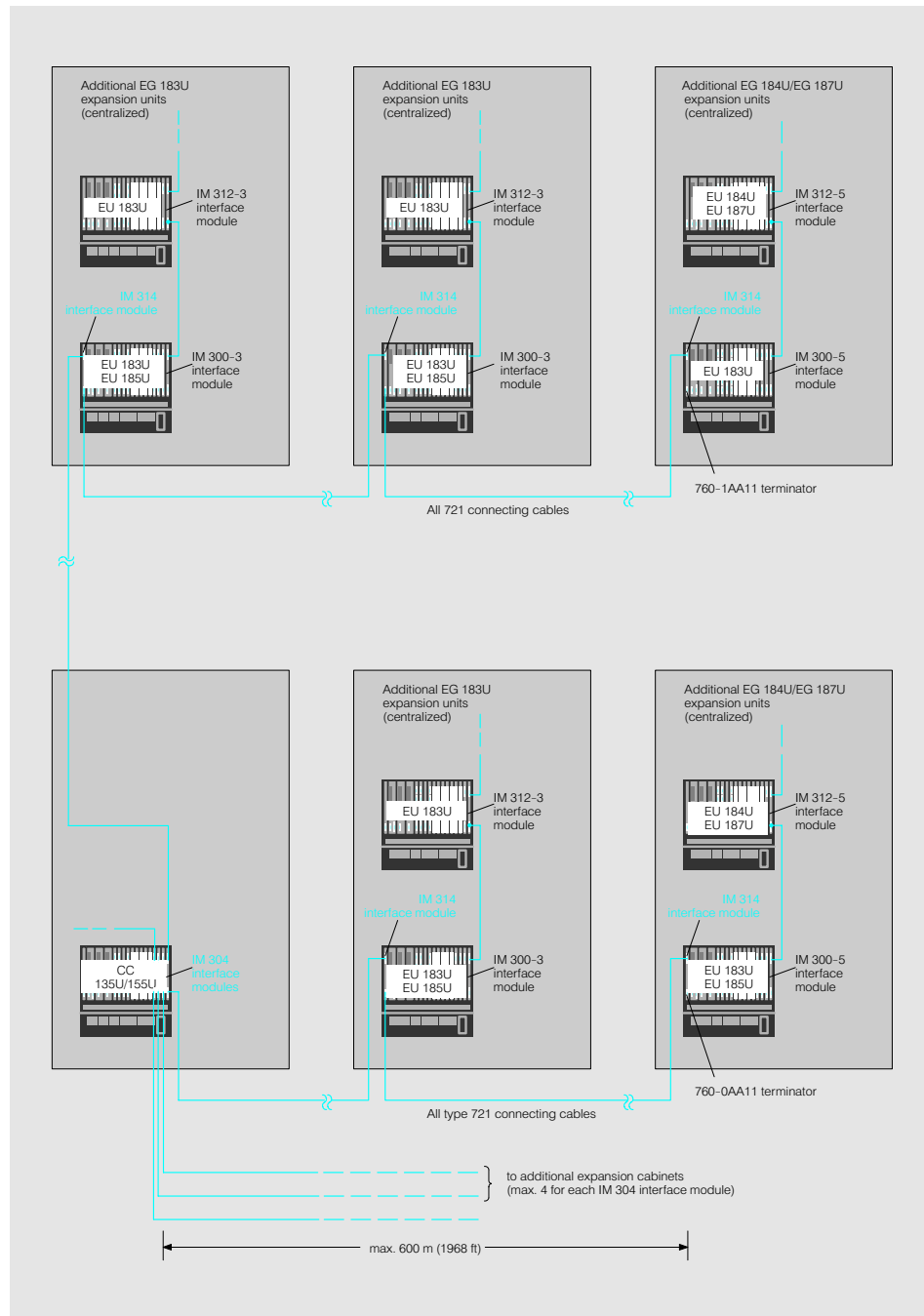

4

Fig. 4/52 Connection of expansion units to the central controller in a distributed configuration using the IM 314 and IM 304 interface modules

## SIMATIC S5-135U, S5-155U/H

## Interface modules

## IM 308 and IM 318 interface modules; distributed configuration up to 3000 m (9900 ft) and ET 100U connection

## Application



The IM 308/IM 318 interface modules are used for distributed configuration of I/O modules with a central controller via the following expansion units:

- EG 183U
- EG 185U

The ET 100U intelligent electronic terminator can also be connected (see Section 6).

The expansion unit and the electronic terminator may be up to 3000 m (9900 ft) away from the central controller.

## 4

## Design

The IM 308 interface module is plugged into the central controller and the IM 318-3 interface module into the expansion unit, or the IM 318-8 interface module into the ET 100U electronic terminator. Up to four IM 308 interface modules can be plugged into the central controller.

Two lines, each containing up to 32 expansion units or ET 100U electronic terminators in any order can be connected to an IM 308 interface module. A total of 63 expansion units and ET 100U electronic terminators can operate via one IM 308 interface module. Digital and analog I/Os can be used in the expansion units and electronic terminators, but not intelligent I/Os or communications processors.

A memory submodule containing the address list is only required for the IM 308 if ET 100U electronic terminators are connected to it.

The central controller and the expansion units or electronic terminators are floating with respect to each other.

The IM 308 interface module allows four areas of 256 byte to be configured (P, Q, IM 3 and IM 4 areas). The IM 3 and IM 4 areas can only be accessed via absolute addresses.

## Cables

The interface modules are to be connected via two-core cables. The modules are supplied together with connectors for connecting the cables using screw terminals. The connectors are provided with

screw terminals for the incoming and the outgoing line. A terminating resistor (120 Ω; supplied with the IM 308) is to be mounted to the connector of the last IM 318. An expansion unit or an ET 100U electronic terminator can be switched off without affecting operation of the other units.

Selecting the cables:  
Shielded, twisted two-core cables are to be used. The resistance of a core must not exceed 50 Ω, irrespective of the cable length. The surge impedance should be around 120 Ω. The capacitance per unit length must be as low as possible (< 60 pF/m). The bottom table shows two types of cable that can be used.

Maximum transmission rates, depending on type of cable

and distance to the last unit of a line:

Type of cable	Distance	Transmission rate		
		500 m (1640 ft)	1000 m (3280 ft)	3000 m (9840 ft)
Siemens control cable type A <sup>1)</sup> 6ES5 707-5AA00		375 kbit/s	187 kbit/s	—
Siemens control cable type B V45551-F21-B5 (1.5 mm <sup>2</sup> , paired)		187 kbit/s	62 kbit/s	31 kbit/s

1) Supplied by the meter

## Technical specifications

Transmission rate (selectable)	31, 62, 187 or 375 kbit/s	Power loss		
Number of units that can be connected	<ul style="list-style-type: none"> <li>• Per connection max. 32</li> <li>• Total max. 63</li> </ul>	• IM 308 max.	2.5 W	
		• IM 318 max.	1.5 W	
Current consumption (at 5 V)		Space requirements	1 slot	
• IM 308 max.	0.5 A	Weight	approx.	0.4 kg (0.88 lb)
• IM 318 max.	0.3 A			

# SIMATIC S5-135U, S5-155U/H

## Interface modules

### IM 308 and IM 318 interface modules; distributed configuration up to 3000 m (9900 ft) and connection of the ET 100U (cont.)

Ordering data	Order No.	Order No.
<b>IM 308 interface module</b> Master interface module for central controller and EG 185U or for connecting up to 63 ET 100Us with S5-115U/H, S5-135U or S5-155U/H programmable controllers via plug-in connection and three terminating resistors	<b>6ES5 308-3UA12</b>	<b>IM 318-3 interface module</b> Slave interface module for EG 183U and EG 185U expansion units  To be ordered as a separate item: <b>Manual Distributed I/Os, IM 308-3U/318-3U</b> German English French
<b>IM 318-8 interface module</b> Slave interface module for ET 100U electronic terminator	<b>6ES5 318-8MA12</b>	<b>6ES5 998-2DP11</b> <b>6ES5 998-2DP21</b> <b>6ES5 998-2DP31</b>

4

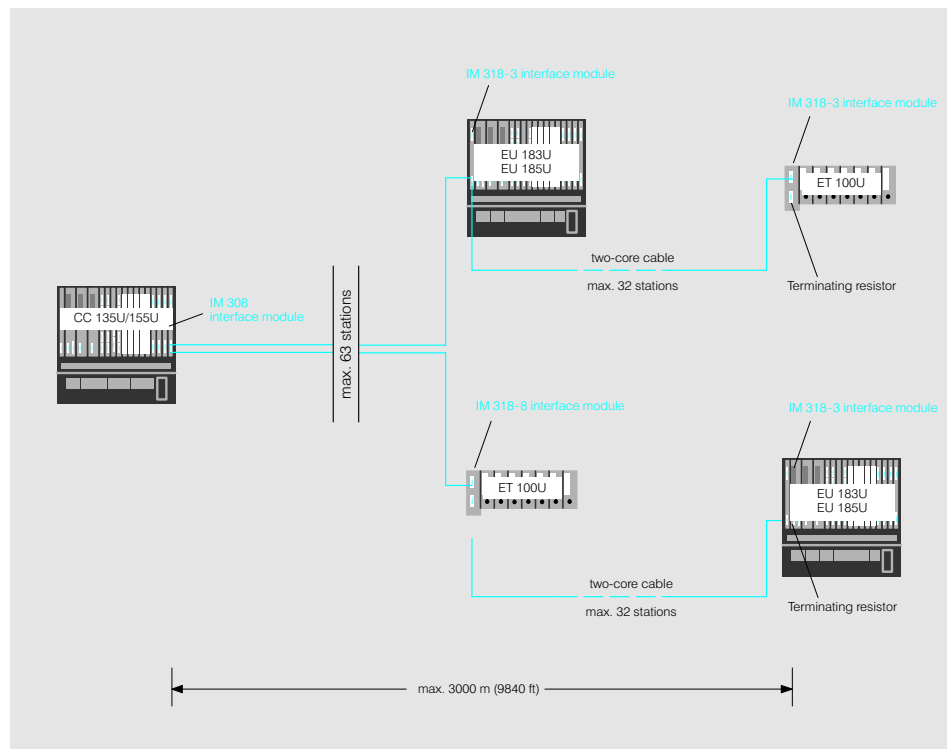

Fig. 4/55 Connection of expansion units and ET 100U to the central controller in a distributed configuration using the IM 318 and IM 308 interface modules



## SIMATIC S5-135U, S5-155U/H

## Interface modules

**IM 308-C interface module; PROFIBUS-DP interface for S5-115U/H up to S5-155U/H****Application**

The IM 308-C is a PROFIBUS-DP master and/or slave module for SIMATIC S5-115U/H up to S5-155U/H.

Up to 122 passive users like, for example, ET200 distributed I/O devices, the S5-95U/DP or field devices with PROFIBUS-DP interface can be connected to an IM 308-C interface module.

4

**Design**

The IM 308-C interface module must be plugged into the slot designed for it in the S5-115U/H up to S5-155U/H programmable controller.

The module requires a single-width slot.

The connection to the PROFIBUS LAN is made via

- a RS 485 bus interface plug or
- a RS 485 bus terminal.

**Principle of operation**

As master module, the IM 308-C interface module coordinates the bus access and the data transfer to the PROFIBUS-DP.

It can also operate as PROFIBUS-DP slave and thus makes data exchange with other PROFIBUS-DP masters possible.

The master and slave function can be used in combination, i.e. as a slave, an IM 308-C interface module receives data from another programmable controller and simultaneously works as master of e.g. ET 200 I/O components.

- Global Control: Sync, Freeze of I/O devices
- Address volume: 13 Kbyte data from the CPU can be addressed per IM 308-C
- Shared Inputs: the inputs of a slave can be read by several IM 308-C interface modules

**Configuration**

Configure this module with the configuration package COM PROFIBUS (see Section 7).

**Technical specifications**

Transfer rate	9.6 kbit/s up to 12 Mbit/s	Data volume	244 byte inputs and outputs per slave
Interfaces at PROFIBUS	9-pin sub D socket	Permissible environmental conditions	0 °C to +60 °C
Supply voltage (via backplane bus)	+5 V DC	• Operating temperature	-40 °C to +70 °C
Current consumption at 5 V DC	max. 0.6 A	• Transport/storage temperature	5 to 95 %
Address volume for inputs, outputs and diagnostics	13 Kbyte	• Relative humidity	
Number of I/O devices which can be connected	max. 122	Mechanical design	Double eurocard
	ET 200 U/B/C, S5-95U/DP and/or other field devices	• Module format	160 × 233.4
		• Dimensions (W × H) in mm	0.5 kg
		• Weight	approx. 1 slot
		• Space requirements	

**Ordering data**

	Order No.		Order No.
<b>IM 308-C interface module</b> for connecting the SIMATIC S5-115U/H, S5-135U, S5-155U/H to PROFIBUS-DP, with memory card (256 kByte)	<b>6ES5 308-3UC11</b>	<b>Memory card</b> 256 Kbyte EPROM 1 Mbyte EPROM	<b>6ES5 374-1KH21</b> <b>6ES5 374-1KK21</b>

# SIMATIC S5-135U, S5-155U/H

## Interface modules

### IM 304 and IM 324R interface modules for interfacing the S5-155H central controllers

#### Application

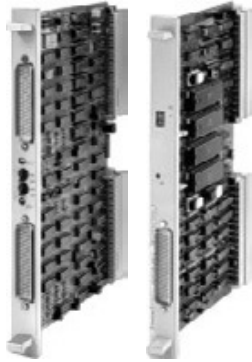

The IM 324R and IM 304 interface modules are used for linking the two ZG 135U/155U central controllers with a S5-155H failsafe programmable controller.

4

#### Design

The IM 324R interface module is plugged into the first central controller (subunit A) and the IM 304 interface module into the second central controller (subunit B). The two interface modules are connected via a 721 connecting cable (max. 100 m (328 ft)).

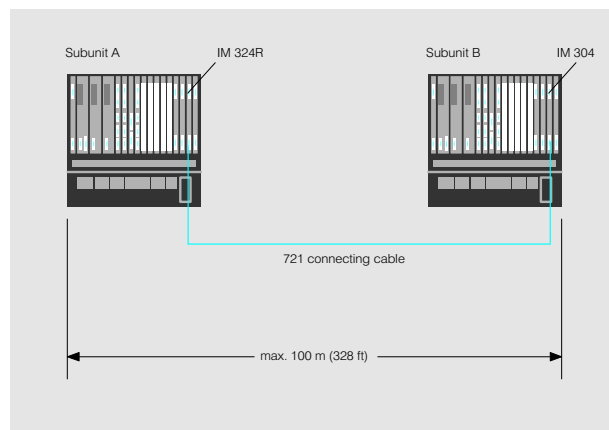

Fig. 4/56 Interfacing of the two central controllers

#### Principle of operation

The two IM 324R and IM 304 interface modules handle all data communications

between the two central controllers of the failsafe programmable controller.

#### Technical specifications

##### Current consumption (at 5 V)

• IM 304	max.	1.5 A
• IM 324R	max.	1.0 A

##### Power loss

• IM 304	max.	7.5 W
• IM 324R	max.	5 W

##### Space requirements

Weight	1 slot 0.3 kg (0.66 lb)
--------	----------------------------

#### Ordering data

	Order No.		Order No.
<b>IM 304 interface module</b> for linking the central controllers of the S5-155H	<b>6ES5 304-3UB11</b>	<b>721 connecting cable</b>	see page 4/142
<b>IM 324R interface module</b> for linking the central controllers of the S5-155H	<b>6ES5 324-3UR11</b>		

# SIMATIC S5-135U, S5-155U/H

## Interface modules

### IM 304 and IM 314R interface modules for switched configuration at S5-155H

#### Application



The IM 304 and IM 314R interface modules are used for the single-channel configuration of the I/O modules of a S5-155H redundant programmable controller.

In addition, the interface modules are recommended for the three-channel input configuration when connecting the EG 185U expansion unit.

4

#### Design

An IM 304 interface module is plugged into each of the two central controllers. Two IM 314R interface modules are plugged into each expansion unit. The interface modules must be interconnected via 721 connecting cables (max. 600 m (1968 ft)). A terminating resistor must be plugged into the last interface module in each chain.

The expansion units (EG 185U) can be situated up to 600 m (1968 ft) away from the central controllers. A maximum of eight lines, each with up to four expansion units, can be connected to the central controllers. The maximum number of expansion units which can be connected is 16.

The following can also be connected to each EG 185U expansion unit:

- Expansion units EG 183U, EG 184U and EG 187U in a centralized configuration using IM 300 interface modules
- Expansion unit EG 183U and the ET 100U electronic terminator in distributed configuration using IM 308 interface modules
- The ET 200 distributed I/O system using the IM 308-C interface module (see Section 6)

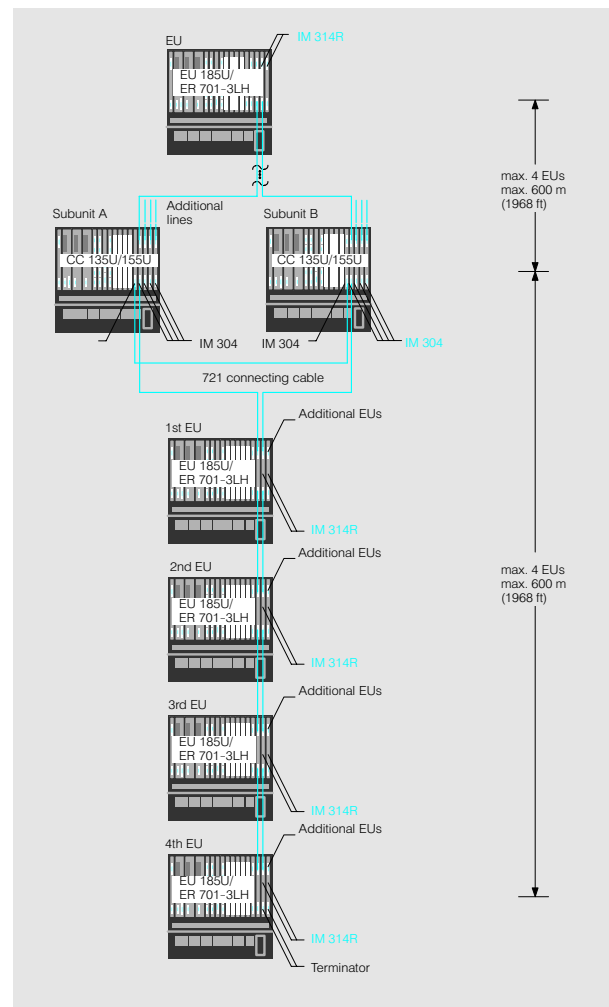

Fig. 4/57 Distributed switched I/O configuration

# SIMATIC S5-135U, S5-155U/H

## Interface modules

### IM 304 and IM 314R interface modules for switched configuration at S5-155H (continued)

#### Principle of operation

The IM 304 and IM 314R interface modules handle all data communications between the respective central controller and the expansion unit.

#### Technical specifications

Current consumption (at 5 V)			Space requirements	1 slot
• IM 304	max.	1.5 A	Weight	approx. 0.3 kg
• IM 314R	max.	1.0 A		
Power loss				
• IM 304	max.	7.5 W		
• IM 314R	max.	5 W		

4

#### Ordering data

	Order No.		Order No.
<b>IM 304 interface module</b> for the central controller	<b>6ES5 304-3UB11</b>	<b>721 connecting cable</b>	see page 4/142
<b>IM 314R interface module</b> for the EG 185U expansion unit	<b>6ES5 314-3UR11</b>		
<b>Terminator for IM 314R</b>	<b>6ES5 760-0HA11</b>		

## SIMATIC S5-135U, S5-155U/H

## Supplementary equipment

## Front connectors

## Application

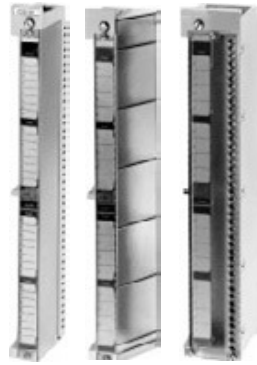

Front connectors must be used to terminate the signal cables for input and output modules. Either crimp terminals or screw terminals can be selected for all modules. Connector sleeves are not required.

## Design

The front connectors are hooked into the module at the bottom, swung towards the module and bolted at the top.

The width of the front connectors corresponds to one of the following:

- 1 slot (single-width) or
- 2 slots (double-width).

Double-width front connectors should always be used for double-width modules or if the slot adjacent to the module at the right is unused (always in the EG 187U expansion unit; without fan).

Stranded conductors should be used for easy movement of the front connectors.

Further types of connection with modified front connectors, prepared cables and terminals for sensors and actuators can be found in the Catalog KT 10 (SITOP power).

## Technical specifications

Front connector	6ES5 497-...	Space in the front connector	
Connection	Crimp terminals or screw terminals	• Cross-section	approx. 470 mm <sup>2</sup>
Conductor cross-section	0.5 ... 1.5 mm <sup>2</sup>	• Number of cables with 2.5 mm <sup>2</sup>	max. 24
• Crimp terminals	0.5 ... 2.5 mm <sup>2</sup>	with 1.5 mm <sup>2</sup>	max. 36
• Screw terminals		with 0.5 mm <sup>2</sup>	max. 48
		Weight	approx. 0.2 kg (0.44 lb)

## Ordering data

	Order No.		Order No.
<b>497-4UA front connector</b> for crimp terminals (without crimp contacts) <ul style="list-style-type: none"> <li>• <b>Width = 1 slot, 42-pin</b> for the following modules (with fan) 6ES5-420..., -430..., -431..., -432..., -434..., -441..., -451..., -458..., -460..., -463..., -465..., -470..., -482..</li> <li>• <b>Width = 2 slots, 42-pin</b> for the modules 6ES5-453..., -454..., -457..., -482.; for the following modules (without fan) 6ES5-420..., -430..., -431..., -432..., -434..., -441..., -451..., -458..., -460..., -463..., -465..., -470..</li> <li>• <b>Width = 2 slots, 20-pin</b> for the following modules 6ES5-435..., -436..., -455..., -456..., -951..</li> </ul>	<b>6ES5 497-4UA12</b>	<b>497-4UB front connector</b> for screw terminals <ul style="list-style-type: none"> <li>• <b>Width = 1 slot, 42-pin</b> for the following modules (with fan) 6ES5-420..., -430..., -431..., -432..., -434..., -441..., -451..., -458..., -460..., -463..., -465..., -470..., -482..</li> <li>• <b>Width = 2 slots, 42-pin</b> for the modules 6ES5-453..., -454..., -457..., -482.; for the following modules (without fan) 6ES5-420..., -430..., -431..., -432..., -434..., -441..., -451..., -458..., -460..., -463..., -465..., -470..</li> <li>• <b>Width = 2 slots, 25-pin</b> for the module 6ES5-454..</li> <li>• <b>Width = 2 slots, 20-pin</b> for the following modules 6ES5-435..., -436..., -455..., -456..., -951..</li> </ul>	<b>6ES5 497-4UB31</b>
	<b>6ES5 497-4UA22</b>		<b>6ES5 497-4UB12</b>
	<b>6ES5 497-4UA42</b>		<b>6ES5 497-4UB22</b>
			<b>6ES5 497-4UB42</b>

# SIMATIC S5-135U, S5-155U/H

## Supplementary equipment

### Front connectors (continued)

Ordering data (continued)	Order No.	Order No.
<b>Front connector K for 6ES5-466..</b> <ul style="list-style-type: none"> <li>For screw terminals Width = 1 slot, 43-pin;</li> <li>For crimp terminals Width = 1 slot, 43-pin;</li> </ul>	<b>6XX3 081</b>  <b>6XX3 068</b>	<b>6XX3 070</b>  <b>6XX3 071</b>
<b>LED extension</b> for front connector with <ul style="list-style-type: none"> <li>screw terminals</li> <li>crimp terminals</li> </ul>	<b>6ES5 497-4UL21</b> <b>6ES5 497-4UL11</b>	<b>6ES5 497-4UC11</b>
		<b>Crimp contacts</b> pack of 250  <b>Crimping tool</b> for crimping crimp contacts  <b>Extraction tool</b> for crimp contacts

4

### Manuals, further accessories

Ordering data	Order No.	Order No.
<b>S5-135U/155U system manual</b> with operating instructions for CC, EU, CPU, IM 300 to IM 314 interface modules, digital input and output modules and analog input and output modules German English French Spanish Italian	<b>6ES5 998-0SH11</b> <b>6ES5 998-0SH21</b> <b>6ES5 998-0SH31</b> <b>6ES5 998-0SH41</b> <b>6ES5 998-0SH51</b>	<b>6ES5 997-3UA 3</b> ↑ 1 2 3 4 5
<b>Programming instructions</b> <ul style="list-style-type: none"> <li>for CPU 922 G, GB, F, E</li> <li>for CPU 928 G, GB, F, E</li> <li>for CPU 928B G, GB, F, E, I</li> <li>for CPU 948 G, GB, F, E, I</li> </ul>	<b>6ES5 998-0PR 1</b> <b>6ES5 998-1PR 1</b> <b>6ES5 998-2PR 1</b> <b>6ES5 998-3PR 1</b>	
<b>Communications manual for CPU 928B</b> G, GB, F, E, I	<b>6ES5 998-0CN 2</b>	
<b>S5-135U/155U manual for CPU 922</b> with S5-135U/155U system manual and programming instructions CPU 922; G, GB, F, E	<b>6ES5 998-0UL 3</b>	
<b>CPU 928</b> with S5-135U/155U system manual and programming instructions CPU 928; G, GB, F, E	<b>6ES5 998-1UL 4</b>	
<b>CPU 928B</b> with S5-135U/155U system manual, communications manual for CPU 928B/ CPU 948 and CPU 928B programming instructions; G, GB, F, E, I	<b>6ES5 998-2UL 4</b>	
<b>CPU 948</b> with S5-135U/155U system manual, communications manual for CPU 928B/ CPU 948 and CPU 922 programming instructions; G, GB, F, E, I	<b>6ES5 998-1UM 2</b>	
German English French Spanish Italian	1 2 3 4 5	
		<b>Manuals (continued)</b>  <b>S5-135U/155U pocket guide</b> for CPU 922, CPU 928, CPU 928B and CPU 948; G, GB, F, E, I  German English French Spanish Italian  <b>S5-155H manual</b> with operating instructions for S5-155H, programming guide and CPU 948R/RL quick reference German English French  <b>Power supply chassis</b> <ul style="list-style-type: none"> <li>230V/120V AC; 5V, 18A; 24V, 1A; 15V, 0.5A for ZG 135U/155U, EG 183U and EG 185U</li> <li>230V/120V AC; 5V, 40A; 24V, 2.8A; 15V, 2A for ZG 135U/155U and EG 185U</li> <li>24V DC; 5V, 18A; 24V, 1A; 15V, 0.5A for ZG 135U/155U, EG 183U and EG 185U</li> <li>24V DC; 5V, 40A; 24V, 2.8A; 15V, 2A for ZG 135U/155U and EG 185U</li> <li>24V DC; 5V, 10A; 24V, 0.8A for ZG 135U</li> </ul> <b>Fan chassis for EG 184U</b> <ul style="list-style-type: none"> <li>230/120V AC</li> <li>24V DC</li> </ul> <b>Spare fan</b> for CC and EUs with power supply chassis 6ES5 955-3..41
		<b>6ES5 998-4SR11</b> <b>6ES5 998-4SR21</b> <b>6ES5 998-4SR31</b>  <b>6ES5 955-3LC41</b>  <b>6ES5 955-3LF41</b>  <b>6ES5 955-3NC41</b>  <b>6ES5 955-3NF41</b>  <b>6ES5 955-3NA12</b>  <b>6ES5 988-3LA11</b> <b>6ES5 988-3NA11</b> <b>6ES5 988-3NB41</b>

## SIMATIC S5-135U, S5-155U/H

## Supplementary equipment

## Manuals, further accessories (continued)

Ordering data (continued)	Order No.	Ordering data (continued)	Order No.
<b>Accessories for ZG 135U/155U, EG 183U to EG 187U (cont.)</b>  <b>Spare fan (set of 2)</b> <ul style="list-style-type: none"> <li>• 230V AC for 6ES5 955-3LC14/-3LF12 and 6ES5 988-3LA11</li> <li>• 24V DC for 6ES5 955-3NA12/-3NC13/-3NF11 and 6ES5 988-3NA11</li> </ul>	<b>6ES5 988-3LB21</b>  <b>6ES5 988-3NB11</b>	<b>Accessories for ZG 135U/155U, EG 183U to EG 187U (cont.)</b>  <b>Dust filter (set of 10)</b> for dust filter holder 6ES5 981-0FA11  <b>Dummy front plates</b> for covering free slots <ul style="list-style-type: none"> <li>• Width 1 slot</li> <li>• Width 2 slots</li> </ul>	<b>6ES5 981-0EA11</b>  <b>6XF2 008-6KB00</b> <b>6XF2 016-6KB00</b>  <b>6ES5 956-0AA12</b>
<b>Backup battery</b> <ul style="list-style-type: none"> <li>• For power supply chassis (3.4V, 5Ah)</li> <li>• For memory submodules with RAM (3V, 0.2Ah)</li> </ul>	<b>6EW1 000-7AA</b>  <b>6ES5 980-0DA11</b>	<b>15 V module</b> for building into power supply chassis 6ES5 955-3NA12/-3NF11/-3LF12 for supplying the bus connector for Industrial Ethernet. All other power supply chassis do not require a 15 V module.	
<b>Rechargeable battery</b> for power supply chassis 6ES5 955-3xx41	<b>6ES5 980-0NC11</b>	<b>Accessories for ZG 155H</b>	
<b>Baffle plate</b> for improving the cooling of devices with fan; air entry from lower front side, air exit upper back side	<b>6ES5 981-0DA11</b>	<b>Power supply</b> 24 V DC; 5 V, 14 A	<b>6ES5 955-7NC11</b>
<b>Dust filter holder</b> for CC and EUs with power supply chassis 6ES5 955-0FA41	<b>6ES5 981-0FA41</b>	<b>Fan subassembly</b> 24 V DC	<b>6ES7 408-1TA01-0XA0</b>
<b>Dust filter (set of 10)</b> for dust filter holder 6ES5 981-0FA41	<b>6ES5 981-0EA41</b>	<b>Replacement fan</b>	<b>6ES7 408-1TA00-6AA0</b>
<b>Dust filter holder</b> for CC and EUs with power supply chassis 6ES5 955-3LC14/-3LF12/-3NA12/-3NC13/-3NF11, 6ES5 988-3xA11	<b>6ES5 981-0FA11</b>	<b>Dust filter (10 items)</b>	<b>6ES7 408-1TA00-7AA0</b>
		<b>Backup battery</b> Lithium, type AA 3.6 V; 1.9 Ah	<b>6ES7 971-0BA00</b>

