

Thyristors

SKT 240 SKT 340



Features

- Hermetic metal cases with ceramic insulators
- Capsule packages for double sided cooling
- Shallow design with single sided cooling
- International standard cases
- Off-state and reverse voltages up to 1800 V

Typical Applications

- DC motor control (e. g. for machine tools)
- Controlled rectifiers (e. g. for battery charging)
- AC controllers (e. g. for temperature control)

V _{RSM}	V _{RRM} V _{DRM}	(dv/dt) _{cr}	I _{TRMS} (maximum values for continuous operation)	
			600 A	700 A
V	V	V/μs	I _{TAV} (sin. 180; T _{case} = . . . ; DSC)	
			380 A (60 °C)	450 A (57 °C)
500	400	500	SKT 240/04 D	SKT 340/04 D
900	800	1000	SKT 240/08 E	SKT 340/08 E
1300	1200	1000	SKT 240/12 E	SKT 340/12 E
1500	1400	1000	SKT 240/14 E	SKT 340/14 E
1700	1600	1000	SKT 240/16 E	SKT 340/16 E
1900	1800	1000	SKT 240/18 E	SKT 340/18 E
2100	2000	1000	SKT 240/20 E	–
2300	2200	1000	SKT 240/22 E	–

Symbol	Conditions	SKT 240	SKT 340	Units
I _{TAV}	sin. 180; (T _{case} = . . .); DSC	240 (92)	340 (82)	A °C
I _{TSM}	T _{vj} = 25 °C; 10 ms	5 000	5 700	A
i ² t	T _{vj} = 125 °C; 10 ms	4 500	5 200	A
	T _{vj} = 25 °C; 8,3 ... 10 ms	125 000	162 000	A ² s
t _{gd}	T _{vj} = 25 °C I _G = 1 A di _G /dt = 1 A/μs	typ. 1		μs
		typ. 2		μs
t _{gr}	V _D = 0,67 · V _{DRM}	125		A/μs
(di/dt) _{cr}	f = 50 ... 60 Hz	150 / 400		mA
I _H	T _{vj} = 25 °C; typ./max.	0,3 / 1		A
I _L	T _{vj} = 25 °C; typ./max.	50 ... 150		μs
t _q	T _{vj} = 125 °C; typ.			
V _T	T _{vj} = 25 °C; I _T = 1000 A; max.	2,3	1,9	V
V _{T(TO)}	T _{vj} = 125 °C	1,0	1,0	V
r _T	T _{vj} = 125 °C	1,4	0,9	mΩ
I _{DD} ; I _{RD}	T _{vj} = 125 °C; V _{RD} = V _{RRM} V _{DD} = V _{DRM}	40	40	mA
V _{GT}	T _{vj} = 25 °C	2		V
I _{GT}	T _{vj} = 25 °C	150		mA
V _{GD}	T _{vj} = 125 °C	0,25		V
I _{GD}	T _{vj} = 125 °C	10		mA
R _{thjc}	cont.; DSC	0,070		°C/W
R _{thch}	sin. 180; DSC/SSC	0,072 / 0,151		°C/W
	rec. 120; DSC/SSC	0,080 / 0,168		°C/W
	DSC/SSC	0,020 / 0,040		°C/W
	T _{vj}	– 40 ... + 125		°C
T _{stg}		– 40 ... + 130		°C
F	SI units	4 ... 5		kN
w	US units	900 ... 1100		lbs.
		61		g
Case	→ page B 3 – 32	B 8		

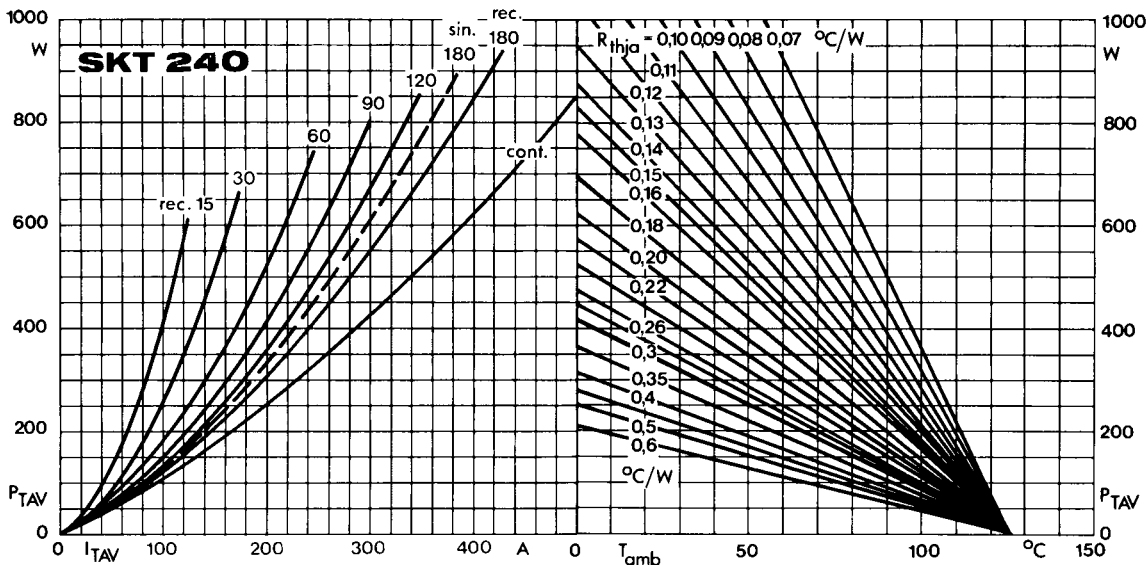

Fig. 1 a Power dissipation vs. on-state current and ambient temperature

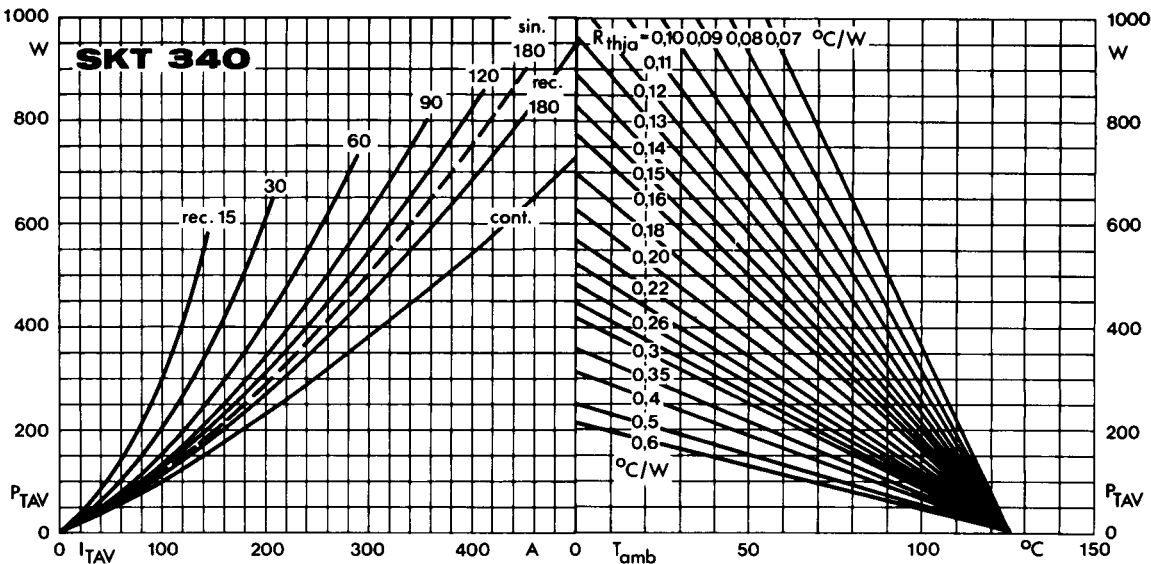

Fig. 1 b Power dissipation vs. on-state current and ambient temperature

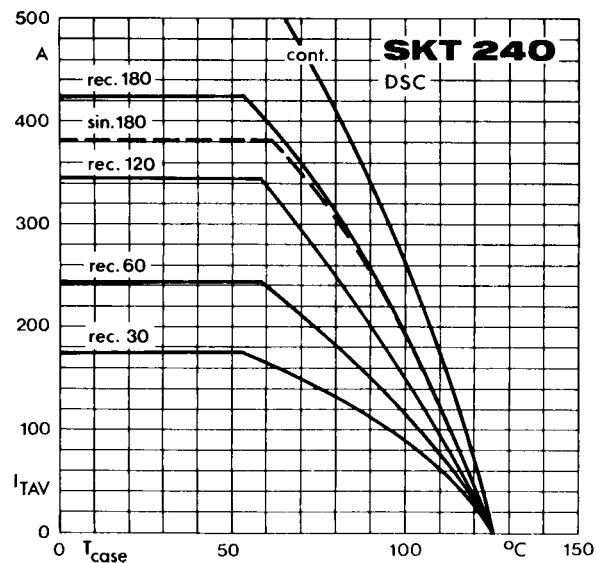

Fig. 2 a Rated on-state current vs. case temperature

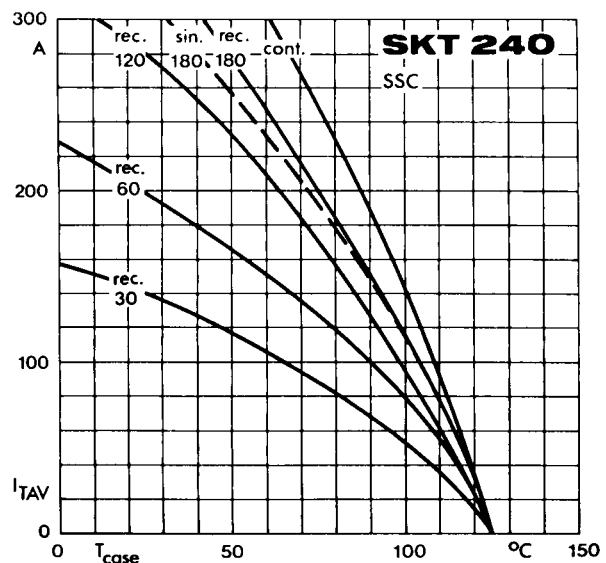

Fig. 2 b Rated on-state current vs. case temperature

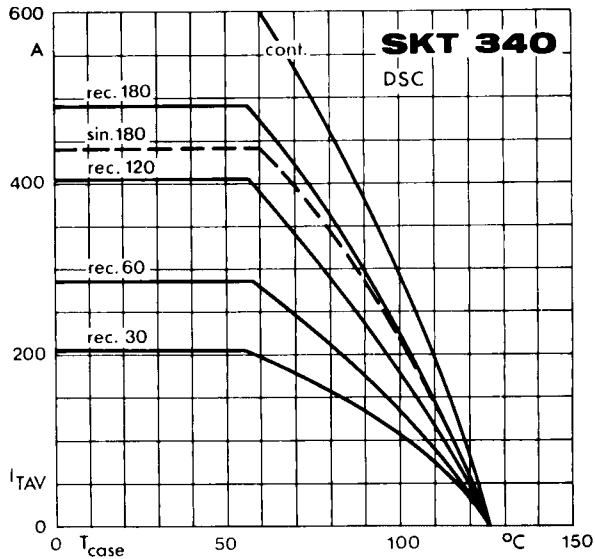

Fig. 2 c Rated on-state current vs. case temperature

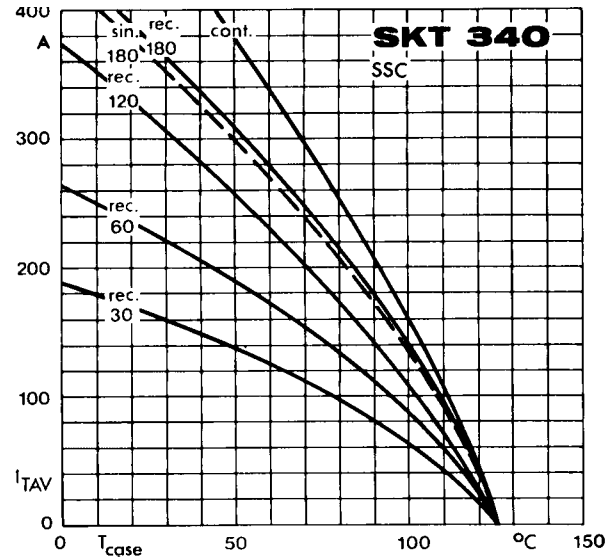

Fig. 2 d Rated on-state current vs. case temperature

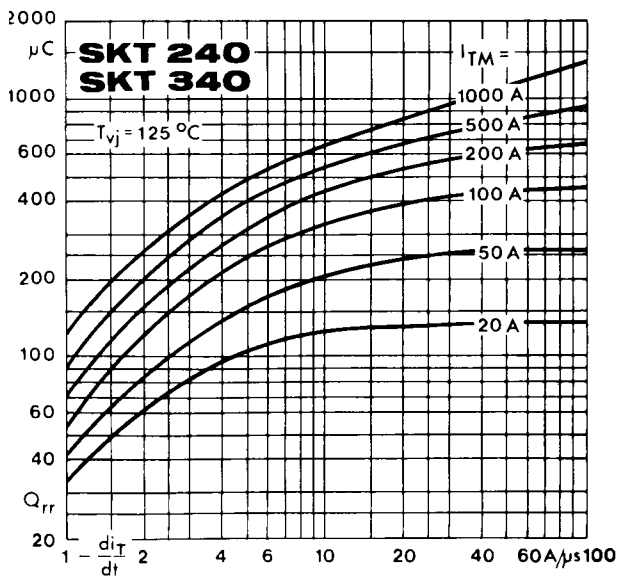

Fig. 3 Recovered charge vs. current decrease

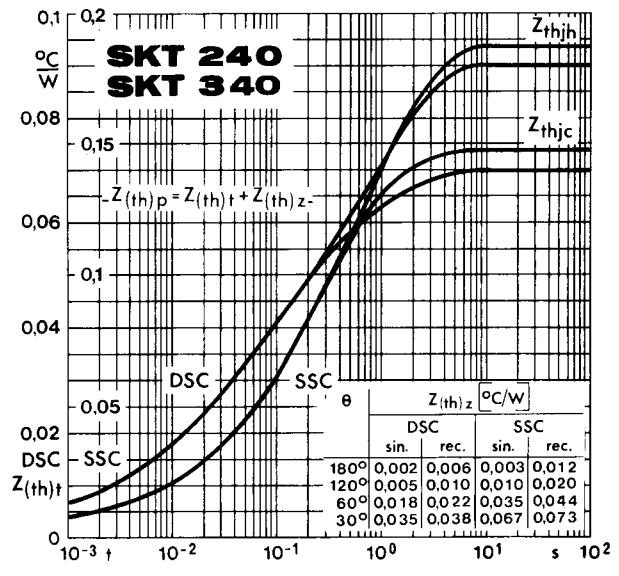

Fig. 4 Transient thermal impedance vs. time

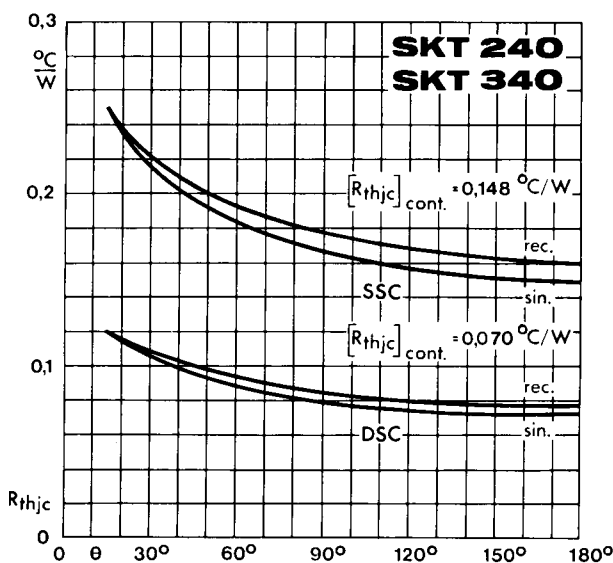

Fig. 5 Thermal resistance vs. conduction angle

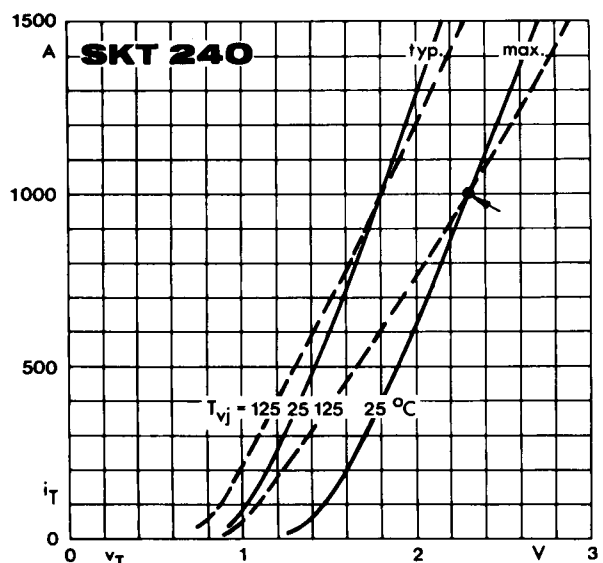

Fig. 6 a On-state characteristics

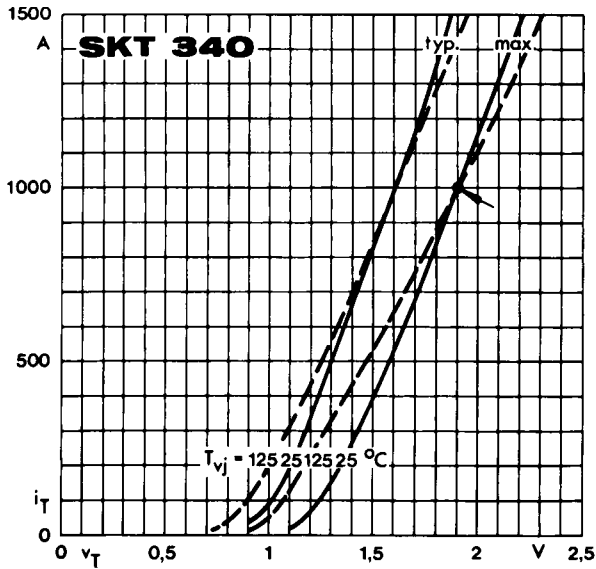

Fig. 6 b On-state characteristics

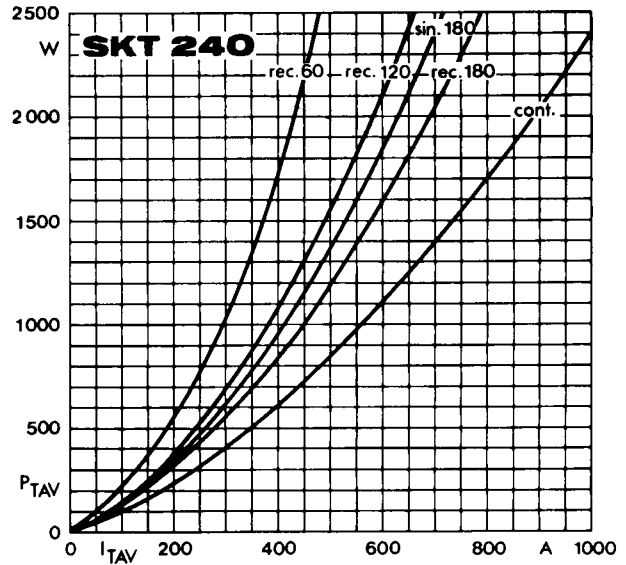

Fig. 7 a Power dissipation vs. on-state current

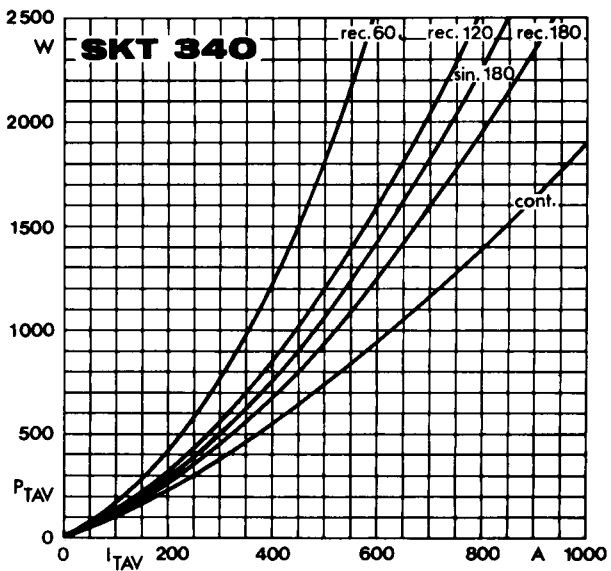

Fig. 7 b Power dissipation vs. on-state current

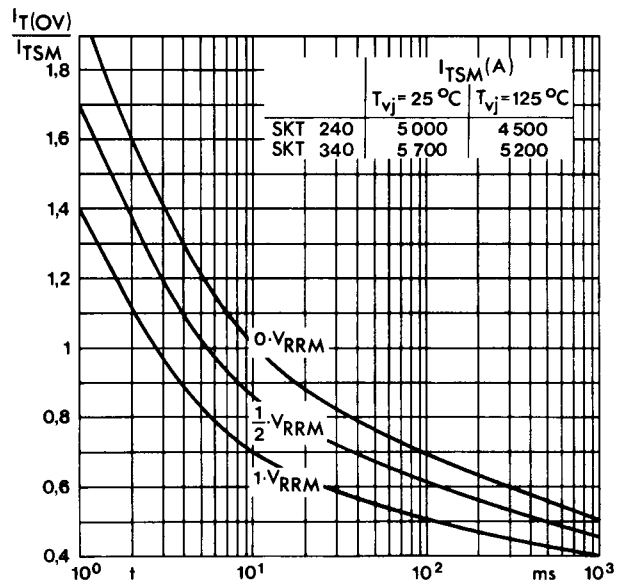

Fig. 8 Surge overload current vs. time

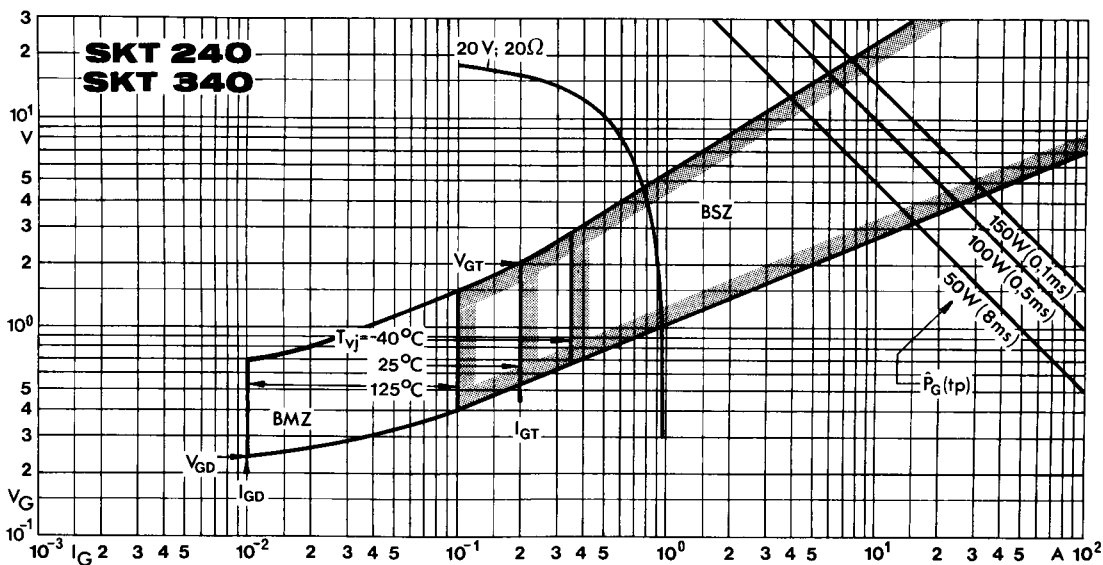
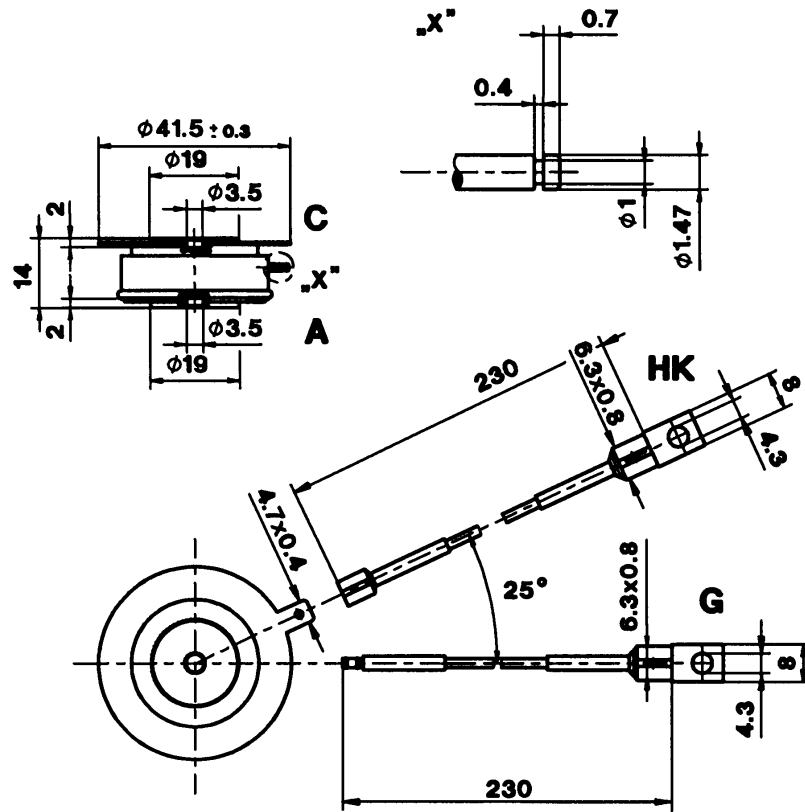

Fig. 9 Gate trigger characteristics

SKT 240
SKT 340

Case B 8

DIN 41814: 151 A 4
JEDEC: TO-200 AB



SKT 491
SKT 551

Case B 11

DIN 41814: 152 A 4
JEDEC: TO-200 AB

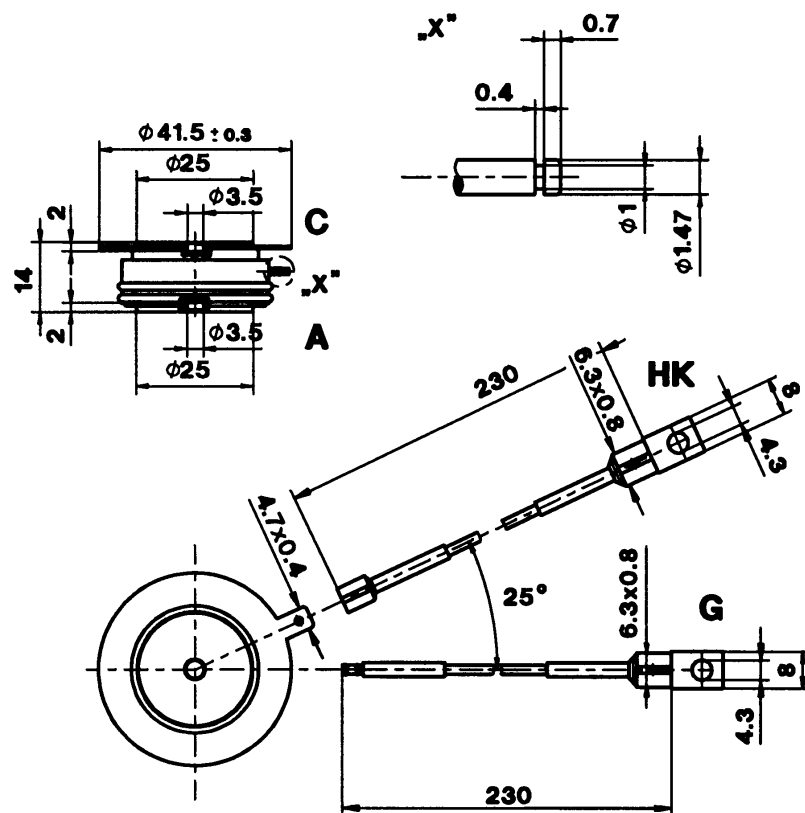

- C: Cathode terminal (red sleeve)
- A: Anode terminal
- G: Gate terminal (yellow sleeve)
- HK: Auxiliary cathode terminal (red sleeve)

Dimensions in mm