



ICR845-2L0020P02 FlexLens Kit

ICR84x-2 FlexLens

IMAGE-BASED CODE READERS

SICK
Sensor Intelligence.



Illustration may differ



Ordering information

Type	Part no.
ICR845-2L0020P02 FlexLens Kit	1047432

Other models and accessories → www.sick.com/ICR84x-2_FlexLens

Detailed technical data

Features

Reading field	Front
Focus	Variable (through exchangeable lens)
Sensor	CMOS Mono
Sensor resolution	752 px x 480 px (WVGA)
MTBF	75,000 h
Lighting	Via pre-mounted ICL300-F222, ring illumination, bright field, red illumination, illumination distance 200 mm to 2 m
Scanning frequency	60 Hz, for WVGA resolution
Code resolution	≥ 0.1 mm ¹⁾
Reading distance	0.1 m ... 3 m ^{1) 2)}
Lens	Pre-mounted 75 mm lens

¹⁾ Depends on lens used; valid for Data Matrix, PDF417, and 1D codes with good printing quality.

²⁾ For details see reading field diagram.

Performance

Bar code types	GS1-128 / EAN 128, UPC / GTIN / EAN, Interleaved 2 of 5, Pharmacode, Code 39, Code 128, Codabar
2D code types	Data Matrix ECC200, GS1 Data-Matrix, QR code
No. of codes per scan	1 ... 50
No. of codes per reading interval	1 ... 50
No. of characters per reading interval	4,000

Interfaces

Serial (RS-232)	Function	✓ Host, AUX
	Data transmission rate	300 Baud ... 57,600 Baud, AUX: 9,600 baud
Ethernet	Function	✓ Host, AUX, image transmission
	Data transmission rate	10/100 MBit/s
	Protocol	TCP/IP, FTP (image transmission), PROFINET (optional via external connection module CDM)

CAN bus	✓
Function	SICK CAN sensor network (Master/Slave, Multiplexer)
Data transmission rate	10 kbit/s ... 1 Mbit/s
Protocol	CANopen, CSN (SICK CAN Sensor Network)
PROFIBUS DP	✓, optional via external connection module (CDM + CMF)
DeviceNet	✓, optional via external connection module (CDM + CMF)
Switching inputs	2
Switching outputs	2 (Result 1 NPN, Result 2 PNP)
Reading pulse	Switching inputs, non-powered, serial interface
Optical indicators	6 LEDs (status displays)
Acoustic indicators	Beeper/buzzer (can be switched off, can be assigned a function to signal a result)

Mechanics/electronics

Electrical connection	1 x RJ45 female connector on the device, cables with 15-pin D-Sub HD male connector (0.9 m, ± 5%)
Operating voltage	15 V DC ... 30 V DC
Power consumption	8 W
Housing	Die-cast zinc
Housing color	Light blue (RAL 5012)
Enclosure rating	IP 65 (EN 60529) ¹⁾ IP 30 ²⁾
Protection class	III (EN 61140)
Weight	900 g, with connecting cable
Dimensions (L x W x H)	123.3 mm x 80 mm x 39 mm

¹⁾ For installed adapter frame, IP 65 Ethernet cable and IP 65 lens cover or for installed adapter frame, IP 65 cover and IP 65 lens cover.

²⁾ Without covered Ethernet connection or with standard Ethernet cable.

Ambient data

Electromagnetic compatibility (EMC)	EN 61000-6-2 / EN 61000-6-4
Vibration resistance	EN 60068-2-6
Shock resistance	EN 60068-2-27
Ambient operating temperature	0 °C ... +40 °C
Storage temperature	-20 °C ... +70 °C
Permissible relative humidity	± 90 %, Non-condensing
Ambient light immunity	2,000 lx, on bar code

General notes

Items supplied	Premounted kit incl. ICR845-2L0020, ICL300-F222 (red), 75 mm lens, IP65 hood, C-mount filter (red), mounting bracket, screws, and connecting cable (2 m) for ring illumination, Ethernet crossover cable, ICR mounting bracket
-----------------------	--

Classifications

ECl@ss 5.0	27280103
ECl@ss 5.1.4	27280103
ECl@ss 6.0	27280103
ECl@ss 6.2	27280103

ICR845-2L0020P02 FlexLens Kit | ICR84x-2 FlexLens

IMAGE-BASED CODE READERS

ECI@ss 7.0	27280103
ECI@ss 8.0	27280103
ECI@ss 8.1	27280103
ECI@ss 9.0	27280103
ETIM 5.0	EC002550
ETIM 6.0	EC002550
UNSPSC 16.0901	43211701

Dimensional drawing (Dimensions in mm (inch))

ICR845-2L FlexLens

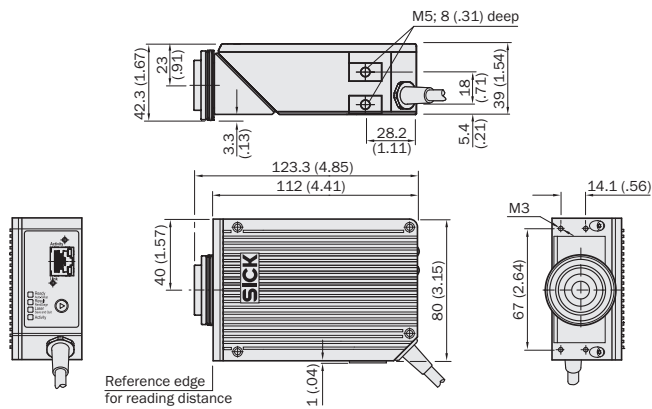

Reading field diagram

Field of view/length in mm (inch)
Illuminated field in mm²

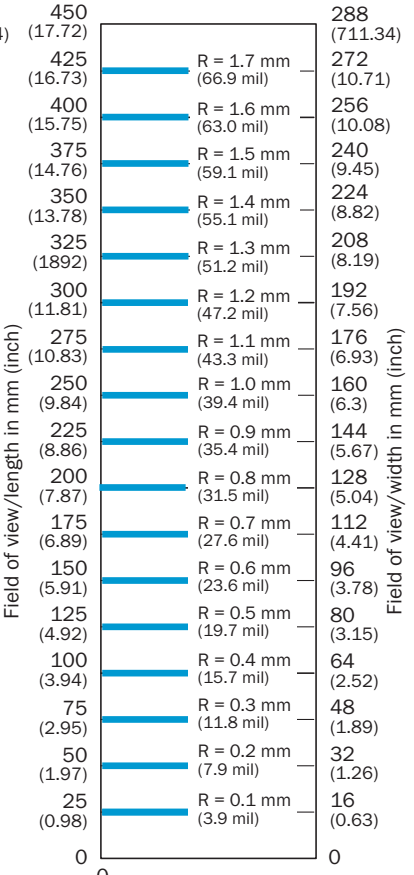
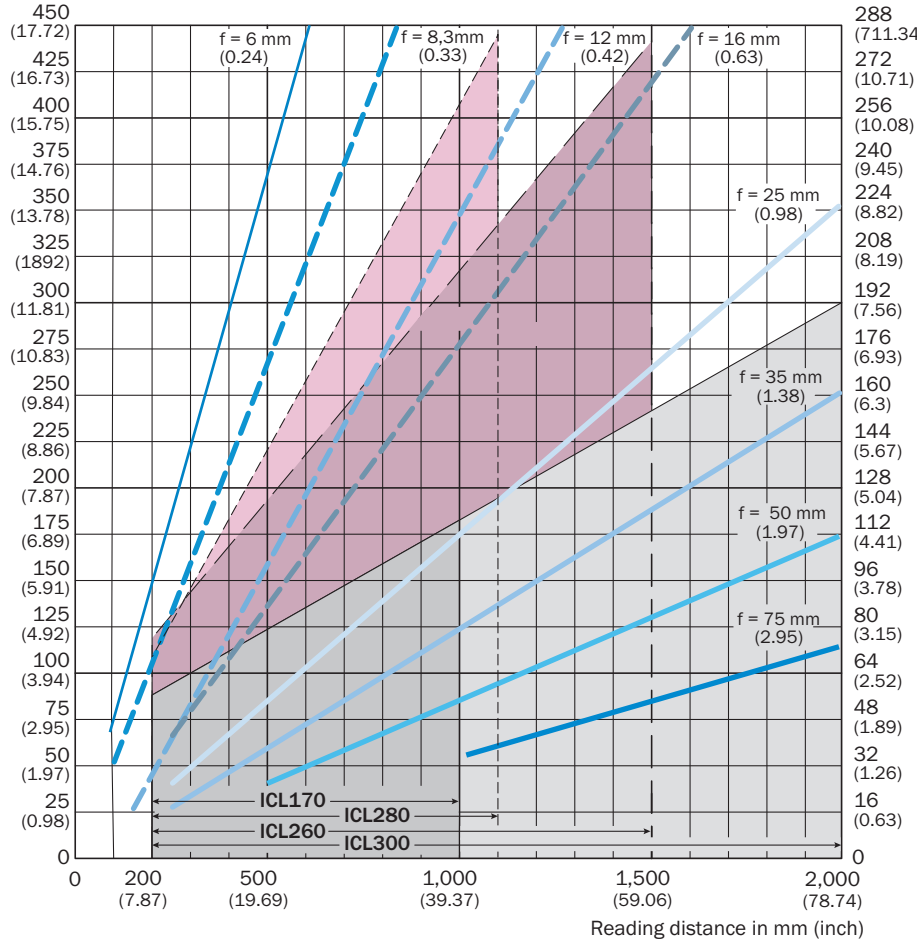







Independent from reading distance
R = resolution

- Illuminated field ICL170-F222
- Illuminated field ICL260-F222
- Illuminated field ICL280-F222, ICL280-F202S01
- Illuminated field ICL300-F222, ICL300-F202S01

Recommended accessories

Other models and accessories → www.sick.com/ICR84x-2_FlexLens

	Brief description	Type	Part no.
Mounting brackets and plates			
	Mounting bracket, adjustable skew angle, mounting hardware included	Mounting bracket	2039465

	Brief description	Type	Part no.
Modules			
	Small connection module for one sensor, 4 cable glands, base for CMC600	CDB620-001	1042256
	Modular connection module for one sensor	CDM420-0001	1025362
Plug connectors and cables			
	Head A: male connector, RJ45 Head B: male connector, RJ45 Cable: Ethernet, unshielded, 3 m	Ethernet crossover cable	6026084
	Head A: male connector, RJ45, 4-pin Head B: male connector, RJ45, 4-pin Cable: Ethernet, unshielded Ethernet connection possible when screw-mounted	Ethernet patch cable (male connector-male connector)	2039986
Lenses and accessories			
	Lens hood to reach IP 65 (C-mount), length: 68.3 mm	IP65 lens hood	2049130
	C-mount lens, 1:1.4, focal length 8 mm, M30,5 x 0,5	OBJ-C00814A	5314041
	C-mount lens, 1:1.4, focal length 12 mm, M30,5 x 0,5	OBJ-C01214A	5314042
	C-mount lens, 1:1.4, focal length 16 mm, M30,5 x 0,5	OBJ-C01614A	5315114
	C-mount lens, 1:1.4, focal length 25 mm, M25,5 x 0,5	OBJ-C02514A	5314043
	C-mount lens 2/3", focal length 50 mm, aperture 1 - 2.3, M25,5 x 0,5	OBJ-C05023A	5319456
	C-mount lens, 1:2.8, focal length 75 mm, M25,5 x 0,5	OBJ-C07528A	5319457
Illuminations			
	Ring lighting set, bright field lighting for ICR84x-2L, red lighting color, lighting distance 0.2 m ... 1 m, incl. mounting bracket, screws, and connecting cable (2 m)	ICL170-F222-Set01-(red)	1048476
	Ring illumination set ICL260-F222, bright field for ICR84x-2L, red illumination, distance 200 mm to 1.5 m incl. mounting bracket, screws and connection cable (2 m) for ring illumination	ICL260-F222-Set01-(red)	1053193
	ICL280-F222 ring lighting set, bright field for ICR84x-2L, red lighting color, lighting distance: 200 mm to 1.1 m, incl. mounting bracket, screws and connection cable (2 m) for ring lighting	ICL280-F222-Set01-(red)	1053194
	Ring lighting, bright field lighting for ICR84x-2L, red lighting color, lighting distance 0.2 m ... 2 m, incl. mounting bracket, screws and connection cable (2 m)	ICL300-F222-Set01-(red)	1047879

SICK AT A GLANCE

SICK is one of the leading manufacturers of intelligent sensors and sensor solutions for industrial applications. A unique range of products and services creates the perfect basis for controlling processes securely and efficiently, protecting individuals from accidents and preventing damage to the environment.

We have extensive experience in a wide range of industries and understand their processes and requirements. With intelligent sensors, we can deliver exactly what our customers need. In application centers in Europe, Asia and North America, system solutions are tested and optimized in accordance with customer specifications. All this makes us a reliable supplier and development partner.

Comprehensive services complete our offering: SICK LifeTime Services provide support throughout the machine life cycle and ensure safety and productivity.

For us, that is “Sensor Intelligence.”

WORLDWIDE PRESENCE:

Contacts and other locations –www.sick.com