



## Modulating control valves MXG461B.. with magnetic actuators, PN 16

for drinking water, cold water and hot water systems,  
DVGW approved

- Short positioning time (< 2 s), high resolution (1 : 1000)
- Selectable valve characteristic: equal-percentage or linear
- High rangeability
- Operating voltage AC / DC 24 V
- Selectable standard signal inputs DC 0/2...10 V or DC 0/4...20 mA
- DC 0...20 V Phs phase-cut signal input for Staefa controllers
- Indication of operating state, visible from the outside
- Accurate position feedback signal by inductive stroke measurement
- Spring return facility: A → AB closed when deenergized
- Low friction, robust and maintenance-free
- Including fittings



### Use

The MXG461B.. valves are mixing or 2-port valves. They are supplied with the magnetic actuator ready fitted, equipped with an electronics module for position control and feedback. They are DVGW approved for drinking water applications.

When deenergized, the valve's control path A → AB is closed.

The short positioning time, high resolution and high rangeability make these valves ideal for modulating control of domestic water (mains water and water in open circuits), hot and cold water systems.

## Type summary

Type reference	DN	k <sub>vs</sub> [m <sup>3</sup> /h]	Δp <sub>max</sub> [kPa]	Δp <sub>s</sub> [kPa]	Operating voltage	Positioning		Spring return
						signal	time	
MXG461B15-0.6	15	0,6	1000	1000	AC /24 V DC 20...30 V	DC 0...10 V or DC 2...10 V or DC 0...20 mA or DC 4...20 mA	< 2 s	✓
MXG461B15-1.5		1,5						
MXG461B15-3		3						
MXG461B20-5	20	5	800	800				
MXG461B25-8	25	8	700	700				
MXG461B32-12	32	12	600	600				
MXG461B40-20	40	20						
MXG461B50-30	50	30						

Δp<sub>max</sub> = max. permissible differential pressure across the valve's control path, valid for the entire actuating range of the motorized valve

Δp<sub>s</sub> = max. permissible differential pressure (close off pressure) at which the motorized valve will close securely against the pressure (used as throughport valve)

## Accessories

Type reference	Description
Z366	Stem heating element for media temperatures < 0 °C, AC / DC 24 V, 10 W

## Ordering

When ordering, please give quantity, product name and type reference.

Type reference	Stock number	Description
MXG461B15-0.6	MXG461B15-0.6	Threaded valve with magnetic actuator
Z366	Z366	Stem heating element

## Delivery

Valve body and magnetic actuator form one assembly and cannot be separated.  
The brass / bronze fittings are part of the delivery.  
The Z366 stem heating element is delivered in a separate package.

## Replacement electronics module

ASE12

Should the valve electronics prove faulty, the electronics module must be replaced by the ASE12 replacement electronics module.  
Mounting Instructions 74 319 0404 0 are included.

## Rev. no.

Overview table, see page 14.

## Technical and mechanical design

For a detailed description of operation, refer to Data Sheet CA1N4028E.

## Control operation

The electronics module converts the positioning signal to a phase-cut power signal which generates a magnetic field in the coil. This causes the armature to change its position in accordance with the interacting forces (magnetic field, counterspring, hydraulics, etc.). The armature responds rapidly to any change in signal, transferring the corresponding movement directly to the valve plug, enabling fast changes in load to be corrected quickly and accurately.

The valve's position is measured continuously. The internal positioning controller balances any disturbance in the system rapidly and delivers the position feedback signal. The valve stroke is proportional to the positioning signal.

## Control

The magnetic actuator can be driven by a Siemens controller or a controller of other manufacture that deliver a DC 0/2...10 V or DC 0/4... 20 mA output signal.  
To achieve optimum control performance, it is recommended to use a 4-wire connection. In case of DC power supply, a 4-wire connection is **mandatory!**

### Spring return facility

If the positioning signal is interrupted, or in the event of a power failure, the valve's return spring will automatically close control path A → AB.

### Manual control

By pressing (a) and turning (b) the hand wheel

- in clockwise (CW) direction, control path A → AB can be mechanically opened to between 80 and 90 %
- in counterclockwise (CCW) direction, the actuator will be switched off and the valve closed

As soon as the hand wheel is pressed and turned, neither the forced control signal Z nor the input signal Y or the phase-cut signal acts on the actuator. The green LED will flash.

For automatic control, the hand wheel must be set to the Auto position. The green LED will be lit.

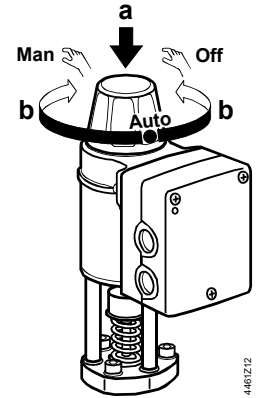

### Operator controls and indicators in the electronics housing

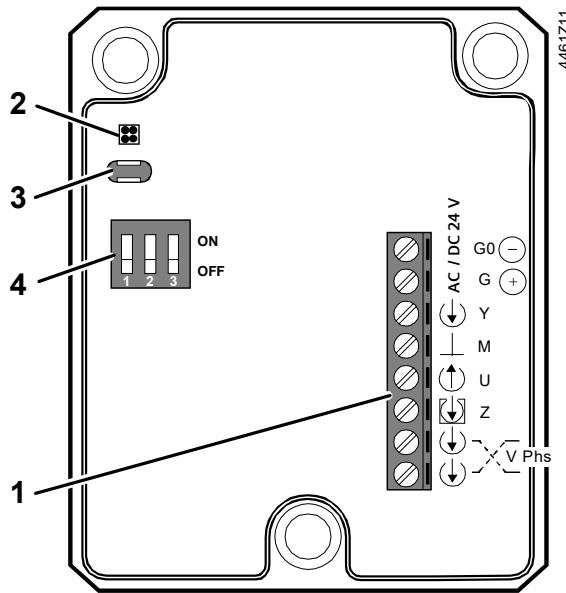

- 1 Connection terminals
- 2 LED for indication of operating state

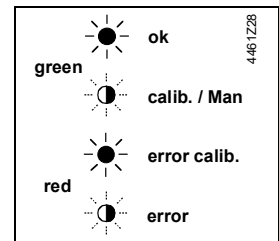

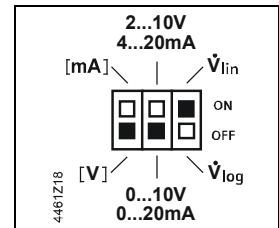

- 3 Slot for autocalibration
- 4 DIL switch for mode control



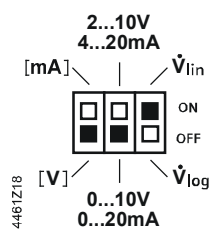

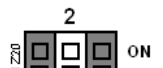
### Configuration DIL switches



Switch	Function	ON / OFF	Description
<b>1</b>  4461Z19	Positioning signal Y	ON	[mA]
		OFF	[V] <sup>1)</sup>
<b>2</b>  4461Z20	Positioning range Y and U	ON	2...10 V, 4...20 mA
		OFF	0...10 V, 0...20 mA <sup>1)</sup>
<b>3</b>  4461Z21	Valve characteristic	ON	$\dot{V}_{lin}$ (linear) <sup>1)</sup>
		OFF	$\dot{V}_{log}$ (equal-percentage)

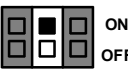

<sup>1)</sup> Factory settings

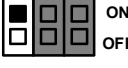
**Selection positioning signal and range Y**  
Voltage and current

↓ Y	 ON OFF	 ON OFF
 ON OFF	0...10 V	2...10 V
 ON OFF	0...20 mA	4...20 mA

4461Z22

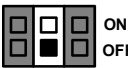
**Selection positioning range Y and U:**  
0...10 V / 0...20 mA or  
2...10 V / 4...20 mA

↑ U	 ON OFF	 ON OFF
$R_i > 500 \Omega$	0...10 V	2...10 V
$R_i < 500 \Omega$	0...20 mA	4...20 mA

4461Z23

Output signal U (position feedback signal) is dependent on the load resistance  $R_i$ .

$R_i > 500 \Omega$ , → voltage signal

$R_i < 500 \Omega$ , → current signal

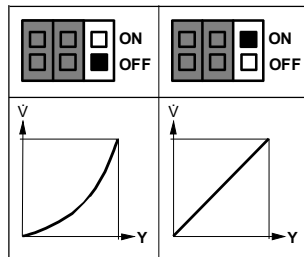

**Selection valve characteristics**

Equal-percentage or linear

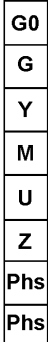

4461Z24

**Forced control input Z**

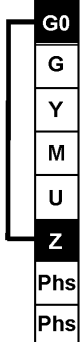
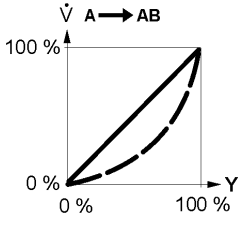
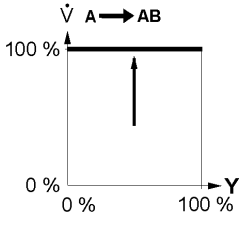
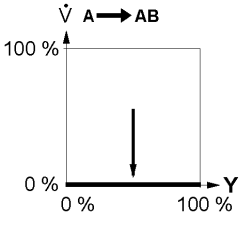
		Z - function		
		no function	fully open	closed
Connections				
Transfer				
Function		<ul style="list-style-type: none"> <li>Z is not connected</li> <li>The valve will follow the Y-signal or phase-cut signal</li> </ul>	<ul style="list-style-type: none"> <li>Z connected to G</li> <li>The valve will fully open via control path A → AB</li> </ul>	<ul style="list-style-type: none"> <li>Z connected to G0</li> <li>The valve will close via control path A → AB</li> </ul>

4461Z13

**Signal priority**

1. Hand wheel position Man (open) or Off
2. Forced control signal Z
3. Phase-cut signal
4. Signal input Y

## Calibration



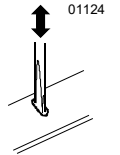

If the electronics module is replaced or the actuator turned through 180 °, the valve's electronics must be recalibrated. For that, the hand wheel must be set to Auto.

The printed circuit board has a slot (position 3, preceding page). Calibration is made by bridging the contacts located behind the slot using a screwdriver. The valve will then travel across the full stroke to store the end positions.



While calibration is in progress, the green LED will flash for about 10 seconds (also refer to «Indication of operating state»).

## Indication of operating state

LED	Indication	Function	Remarks, troubleshooting
Green	Lit 	Control mode	Normal operation; everything o.k.
	Flashing 	Calibration In manual control	Wait until calibration is finished (green or red LED will be lit) Hand wheel in Man or Off position
Red	Lit 	Calibration error Internal error	Recalibrate (bridge contacts behind the calibration slot) Replace electronics module
	Flashing 	Mains fault DC Supply - / +	Check mains network (outside the frequency or voltage range) DC supply + / - connection rectify
Both	Dark 	No power supply Electronics faulty	Check mains network, check wiring Replace electronics module

## Sizing

### Flow chart

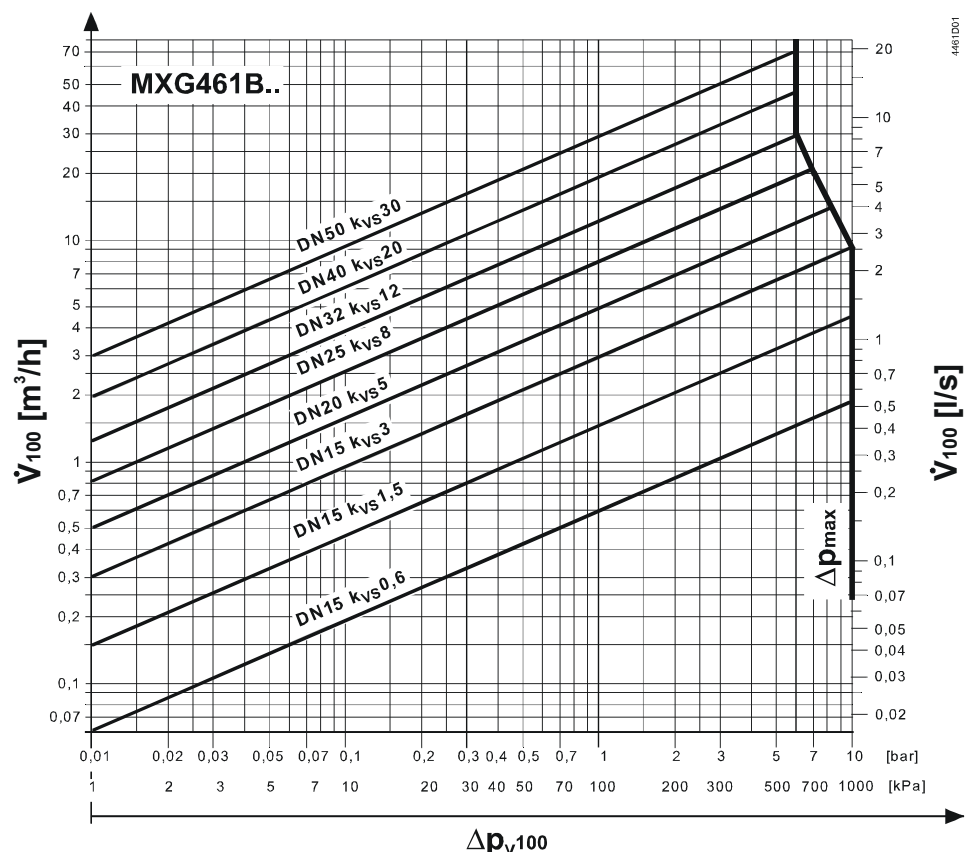

$\Delta p_{V100}$  = differential pressure across the fully open valve and the valve's control path A → AB by a volume flow  $V_{100}$

$V_{100}$  = volume flow through the fully open valve ( $H_{100}$ )

$\Delta p_{max}$  = max. permissible differential pressure across the valve's control path for the entire actuating range of the motorized valve

100 kPa = 1 bar ≈ 10 mWC

1 m<sup>3</sup>/h = 0,278 l/s water at 20 °C

## Valve characteristic

### Equal percentage

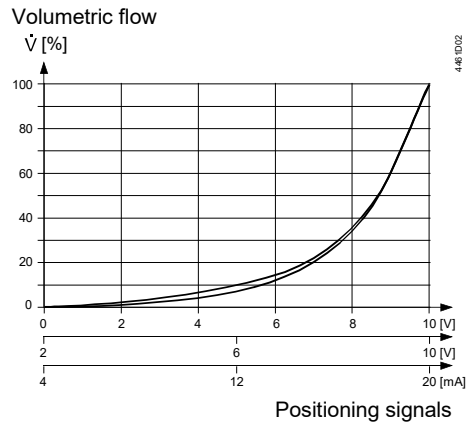

### Linear

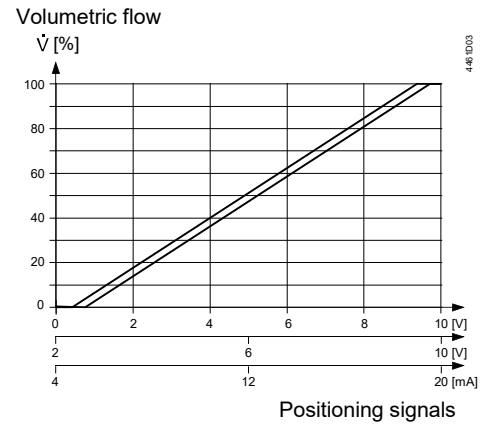

## Connection type <sup>1)</sup>

The 4-wire connection should always be given preference!

### 4-wire connection

Type reference	S <sub>NA</sub> [VA]	P <sub>MED</sub> [W]	S <sub>TR</sub> [VA]	P <sub>TR</sub> [W]	I <sub>F</sub> [A]	Wire cross-section [mm <sup>2</sup> ]		
						1,5	2,5	4,0
MXG461B15-0.6	33	15	≥50	≥50	3.15	60	100	160
MXG461B15-1.5								
MXG461B15-3								
MXG461B20-5								
MXG461B25-8								
MXG461B32-12	43	20	≥75	≥70	4	40	70	120
MXG461B40-20								
MXG461B50-30	65	26	≥100		6.3	30	50	80

S<sub>NA</sub> = nominal apparent power

P<sub>med</sub> = typical power consumption in the application

S<sub>TR</sub> = Minimal apparent transformer power

P<sub>TR</sub> = Minimum DC supply power

I<sub>F</sub> = Minimal required slow fuse

L = max. cable length; with 4-wire connections, the max. permissible length of the separate 1.5 mm<sup>2</sup> copper positioning signal wire is 200 m

<sup>1)</sup> All information at AC 24 V or DC 24V

## Engineering notes

Conduct the electric connections in accordance with local regulations on electric installations as well as the internal or connection diagrams.

Attention

**Safety regulations and restrictions designed to ensure the safety of people and property must be observed at all times!**

**A strainer should be fitted upstream of the valve. This increases reliability.**

## Mounting notes

The valve is supplied complete with Mounting Instructions 74 319 0378 0.

Caution

**The valve may only be used as a mixing or throughport valve, not as a diverting valve. Observe the direction of flow!**

## Orientation

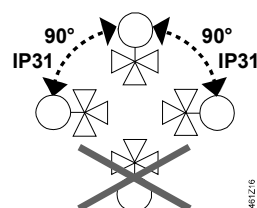

## When used as a throughport valve

The MXG461B.. valves are supplied as three-port valves, but can also be used as throughport valves: In that case, close off port "B" with the accessories provided (nut, cover and gasket).

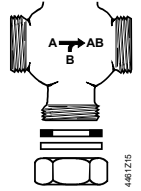

## Installation notes

- The MXG461B.. valves are flat-faced allowing sealing with the gaskets provided
- Do not use hemp for sealing the valve body threads
- The actuator may not be lagged

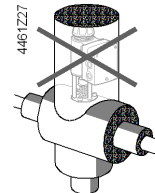
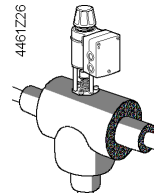
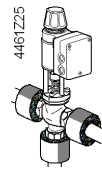

For electrical installation, refer to «Connection diagrams».

## Maintenance notes

The valves are maintenance-free.

The low friction and robust design make regular servicing unnecessary and ensure a long service life.

The valve stem is sealed from external influences by a maintenance-free gland.

If the red LED is lit, the electronics must be recalibrated or replaced.

### Repair

Should the valve electronics prove faulty, the electronics module must be replaced by the ASE12 replacement electronics module (refer to Mounting Instructions 74 319 0404 0).



**Always disconnect power before fitting or removing the electronics module.**

After replacing the electronics module, calibration must be triggered in order to optimally match the electronics to the valve (refer to «Calibration»).

## Disposal



The device is considered electrical and electronic equipment for disposal in terms of the applicable European Directive and may not be disposed of as domestic garbage.

- Dispose of the device through channels provided for this purpose.
- Comply with all local and currently applicable laws and regulations.

## Warranty

Application-specific technical data must be observed.

**If specified limits are not observed, Siemens will not assume any responsibility.**

## Technical data

### Functional actuator data

Power supply	Extra low-voltage only (SELV, PELV)		
AC 24 V	Operating voltage	AC 24 V $\pm 20\%$ (SELV) or AC 24 V class 2 (US)	
	Frequency	45...65 Hz	
	Typical power consumption	$P_{med}$ refer to table «Connection type», page 6 Standby < 1 W (valve closed)	
	Rated apparent power $S_{NA}$	refer to table «Connection type», page 6	
	Required fuse $I_F$	slow, refer to table «Connection type»	
	External supply line protection	Fuse slow max. 10 A or Circuit breaker max. 13 A Characteristic B, C, D according to EN 60898 or Power source with current limitation of max. 10 A	
	DC 24 V	Operating voltage	DC 20...30 V
		Current draw at DC 24 V	0,5 A / 4 A (max.)
		Positioning signal Y or Phase Cut signal Phs	DC 0/2...10 V or DC 0/4...20 mA 0...20 V
		Impedance	DC 0/2...10 V 100 k $\Omega$ // 5nF (load < 0.1 mA) DC 0/4...20 mA 240 $\Omega$ // 5nF
Input	Forced control Z		
	Impedance	22 k $\Omega$	
	Close valve (Z connected to G0)	< AC 1 V; < DC 0,8 V	
	Open valve (Z connected to G)	> AC 6 V; > DC 5 V	
Output	No function (Z not wired)	phase-cut- or positioning signal Y active	
	Position feedback signal U	Voltage	DC 0/2...10 V; load resistance > 500 $\Omega$
		Current	DC 0/4...20 mA; load resistance $\leq$ 500 $\Omega$
	Stroke measurement	Inductive	
Nonlinearity	$\pm 3\%$ of end value		
Positioning time	Positioning time	< 2 s	
Electrical connections	Cable entries	2 x $\varnothing$ 20,5 mm (for M20)	
	Connection terminals	screw terminals for 4 mm <sup>2</sup> wires	
	Min. wire cross-section	0,75 mm <sup>2</sup>	
	Max. cable length	refer to «Connection type», page 6	



<b>Functional valve data</b>	PN class	PN 16 to EN 1333
	Permissible operating pressure <sup>1)</sup>	1,6 MPa (16 bar)
	Differential pressure $\Delta p_{\max} / \Delta p_s$	refer to table «Type summary»
	Leakage rate at $\Delta p = 0,1 \text{ MPa (1 bar)}$	A → AB max. 0,05 % $k_{vs}$ B → AB < 0,2 % $k_{vs}$ depending on operating conditions
	Valve characteristic <sup>3)</sup>	equal percentage, $n_{gl} = 3$ to VDI / VDE 2173 or linear, optimized near the closing point
	Permissible media	drinking water, cooling, cold and hot water, water with anti-freeze; recommendation: water treatment to VDI 2035
	Medium temperature <sup>2)</sup>	−20...130 °C
	Stroke resolution $\Delta H / H_{100}$	1 : 1000 (H = stroke)
	Position when deenergized	A → AB closed
	Mounting position	upright to horizontal
	Mode of operation	modulating
	<b>Materials</b>	Valve body, covering flange
Seat / plug		CrNi steel
Valve stem seal		EPDM (O-ring)
<b>Dimensions / weight</b>	Dimensions	refer to «Dimensions»
	Weight	refer to «Dimensions»
<b>Pipe connections</b>	Fittings	bronze / brass
<b>Standards, directives and approvals</b>	Electromagnetic compatibility (Application)	For residential, commercial and light-industrial environments
	Product standard	EN60730-x
	EU Conformity (CE)	CA2T4461.1 <sup>4)</sup>
	RCM Conformity	A5W00004453 <sup>4)</sup>
	EAC Conformity	Eurasia Conformity for all MXG..
	Housing protection	
	Upright to horizontal	IP31 to EN 60529
	Vibration <sup>5)</sup>	IEC 60068-2-6 (1 g acceleration, 1...100 Hz, 10 min)
	Conform to	UL standards CSA, Canada
		UL 873 C22.2 No. 24
	Environmental compatibility	The product environmental declarations CE2E4461.1en <sup>4)</sup> and CE2E4461.2en <sup>4)</sup> contains data on environmentally compatible product design and assessments (RoHS compliance, materials composition, packaging, environmental benefit, disposal).
	Pressure Equipment Directive	PED 2014/68/EU
	Pressure accessories	Scope: Article 1, section 1 Definitions: Article 2, section 5
	Fluid group 2	without CE-marking as per article 4, section 3 (sound engineering practice) <sup>6)</sup>
	DVGW-Reg.-Nr.	DW-6340BR0230

<sup>1)</sup> Tested at 1.5 x PN (24 bar), similar to EN 12266-1

<sup>2)</sup> For medium temperatures < 0 °C, the Z366 stem heating element is required

<sup>3)</sup> Can be selected via DIL switch

<sup>4)</sup> The documents can be downloaded from <http://siemens.com/bt/download>.

<sup>5)</sup> In case of strong vibrations, use high-flex stranded wires for safety reasons.

<sup>6)</sup> Valves where PS x DN < 1000, do not require special testing and cannot carry the CE label.

**General environmental conditions**

	<b>Operation</b> IEC 60721-3-3	<b>Transport</b> IEC 60721-3-2	<b>Storage</b> IEC 60721-3-1
Climatic conditions	Class 3K5	Class 2K3	Class 1K3
Temperature	-5...+45 °C	-25...+70 °C	-5...+45 °C
Humidity	5...95 % r.h.	5...95 % r.h.	5...95 % r.h.
Mechanical conditions	IEC 60721-3-6 Class 6M2		

**Connection terminals**

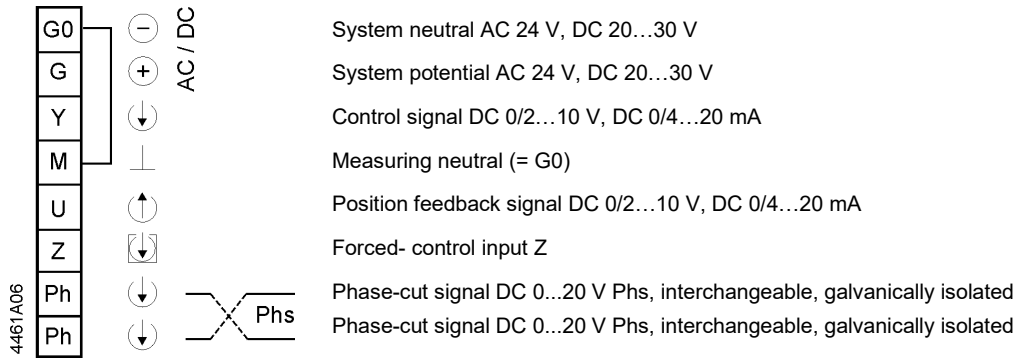

## Connection diagrams

**Caution**  **If controller and valve receive their power from separate sources, only one transformer may be earthed on the secondary side.**

**Caution**  **In case of DC power supply, a 4-wire connection is mandatory!**

### Terminal assignment for controller with 4-wire connection (to be preferred!).

DC 0...10 V  
DC 2...10 V  
DC 0...20 mA  
DC 4...20 mA

#### Common Transformer

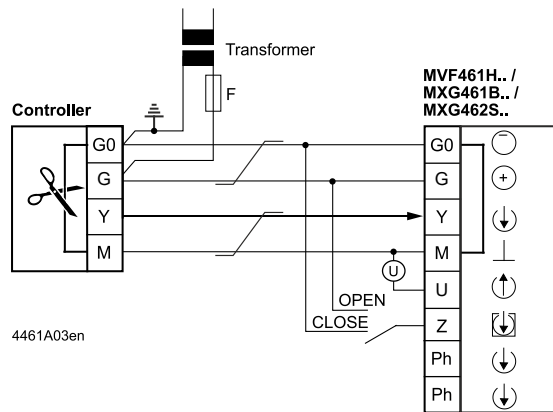

#### Separate Transformer

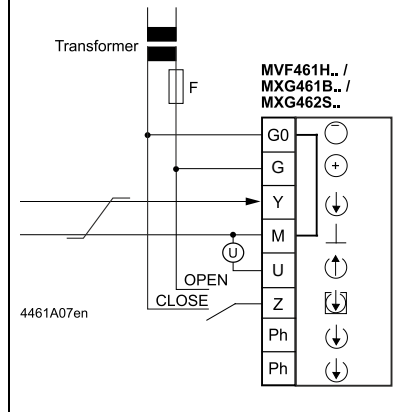

### Terminal assignment for controller with 3-wire connection

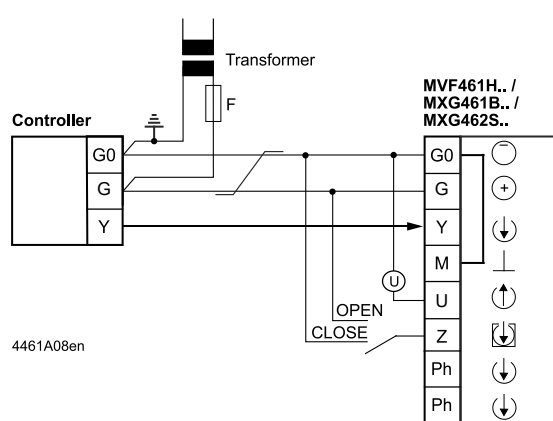

DC 0...10 V  
DC 2...10 V  
DC 0...20 mA  
DC 4...20 mA

#### Common Transformer

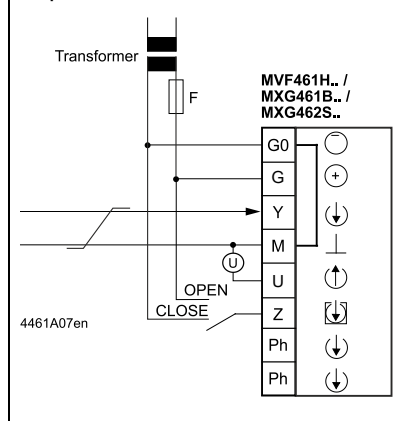

#### Separate Transformer



-  Indication of valve position (only if required). DC 0 ...10 V → 0...100 % volumetric flow  $V_{100}$
-  Twisted pairs. If the lines for AC 24 V power supply and the DC 0...10 V (DC 2...10 V, DC 4...20 mA) positioning signal are routed separately, the AC 24 V line need not be twisted.

## Warning

**Piping must be connected to potential earth!**

**Controllers with phase-cut DC 0...20 V Phs**

**Common Transformer**

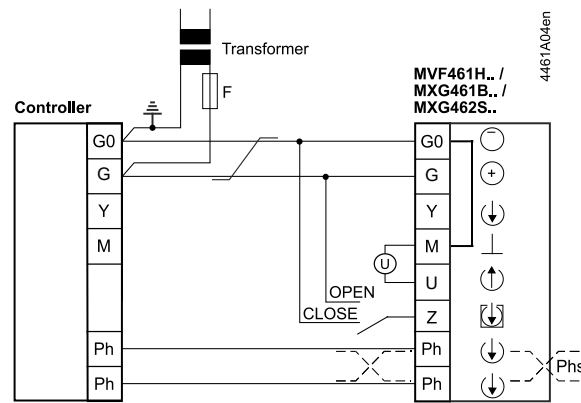

**Separate Transformer**

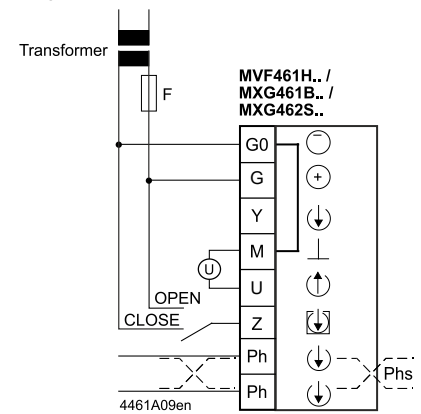

**Stem heating element Z366**

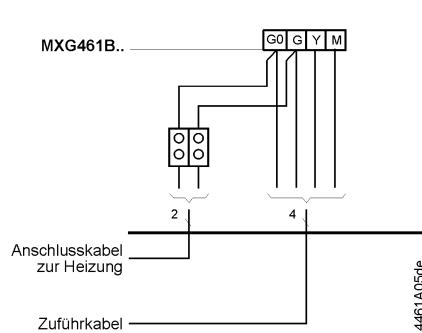

- 2 AC / DC 24 V power supply for heating element
- 4 Power supply, positioning signals

**Application examples**

**Hydraulic circuits**

The examples shown below are basic diagrams with no installation-specific details.

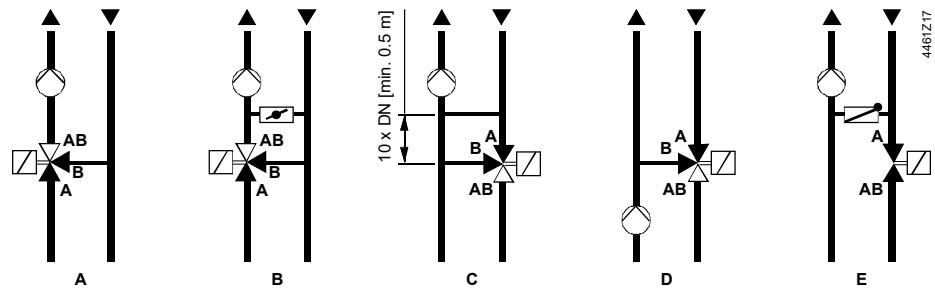

- A Mixing circuit
- B Mixing circuit with bypass (underfloor heating system)
- C Injection circuit
- D Diverting circuit
- E Injection circuit with throughport valve

## Dimensions

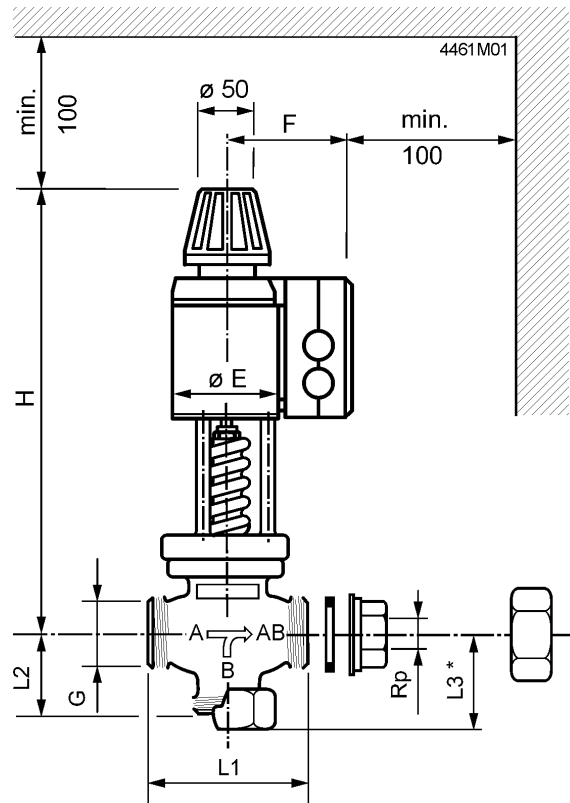

Externally threaded G...B to ISO 228-1  
Internally threaded Rp... to ISO 7-1

Fittings to ISO 49 / DIN 2950  
(supplied complete with flange gaskets)

Type reference	DN	G [Inch]	Rp [Inch]	L1 [mm]	L2 [mm]	L3 * [mm]	H [mm]	E [mm]	F [mm]	Weight <sup>1)</sup> [kg]
<b>MXG461B15-0.6</b>	15	G1B	Rp ½	80	42,5	50	340	80	115	7,1
<b>MXG461B15-1.5</b>	15	G1B	Rp ½	80	42,5	50	340	80	115	7,3
<b>MXG461B15-3</b>	15	G1B	Rp ½	80	42,5	50	340	80	115	7,3
<b>MXG461B20-5</b>	20	G1¼B	Rp ¾	95	52,5	60	339	80	115	7,7
<b>MXG461B25-8</b>	25	G1½B	Rp 1	110	56,5	64	346	80	115	8,5
<b>MXG461B32-12</b>	32	G2B	Rp 1¼	125	67,5	75	384	100	125	12,8
<b>MXG461B40-20</b>	40	G2¼B	Rp 1½	140	80,5	93	401	100	125	14,6
<b>MXG461B50-30</b>	50	G2¾B	Rp 2	170	93,5	108	402	100	125	18,6

\* When used as a throughport valve

<sup>1)</sup> Weight incl. packaging

## Revision numbers

---

Type reference	Valid from rev. No.
MXG461B15-0.6	..D
MXG461B15-1.5	..D
MXG461B15-3	..D
MXG461B20-5	..C
MXG461B25-8	..C
MXG461B32-12	..C
MXG461B40-20	..C
MXG461B50-30	..C

Issued by  
Siemens Switzerland Ltd  
Building Technologies Division  
International Headquarters  
Gubelstrasse 22  
6301 Zug  
Switzerland  
Tel. +41 58-724 24 24  
[www.siemens.com/buildingtechnologies](http://www.siemens.com/buildingtechnologies)

© Siemens Switzerland Ltd, 2010  
Technical specifications and availability subject to change without notice.